

Infrared Receiver Module IRM-36xxJ15 Series

Preliminary

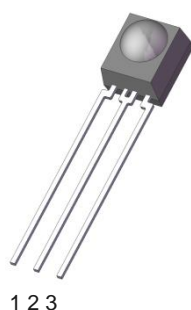

Pin Configuration

1. Out
2. Gnd
3. V_{CC}

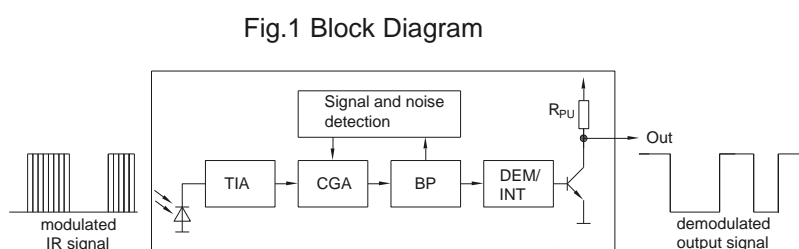

This is a preliminary specification intended for design purposes and subject to change without prior notice.

Features

- Circular lens for improved reception characteristics
- Available for various carrier frequencies
- Low operating voltage and low power consumption
- Optimized immunity against TFT backlight interferences
- High immunity against ambient light
- Long reception range
- High sensitivity
- Pb free and RoHS compliant
- Compliance with EU REACH
- Compliance Halogen Free (Br < 900 ppm, Cl < 900 ppm, Br+Cl < 1500 ppm)

Description

The IRM-36xxJ15 devices are DIP type infrared receivers which have been developed and designed by using the latest IC technology, providing compatibility to most common IR protocols.

The PIN diode and preamplifier are assembled onto a lead frame and molded into a black epoxy package which operates as an IR filter. The demodulated output signal can directly be decoded by a microprocessor.

Applications

- AV equipment such as TV, VCR, DVD, CD, MD, etc.
- CATV set top boxes
- Multi-media Equipment
- Other devices using IR remote control

Part number table

Model No.	Carrier Frequency f_c
IRM-3636J15	36 kHz
IRM-3638J15	38 kHz
IRM-3640J15	40 kHz

Absolute Maximum Ratings ($T_a=25^\circ\text{C}$) (note1)

Parameter	Symbol	Rating	Unit
Supply Voltage	V_{CC}	0 ~ 6	V
Output current	I_{OUT}	0 ~ 2.5	mA
Operating Temperature	T_{opr}	-20 ~ +80	$^\circ\text{C}$
Storage Temperature	T_{stg}	-40 ~ +85	$^\circ\text{C}$
Soldering Temperature (note2)	T_{sol}	260	$^\circ\text{C}$

Electro-Optical Characteristics ($T_a=25^\circ\text{C}$, $V_{CC}=5\text{V}$)

Parameter	Symbol	Min.	Typ.	Max.	Unit	Condition
Current consumption	I_{CC}	0.1	0.23	0.60	mA	No input signal
Supply voltage	V_{CC}	2.7	---	5.5	V	
Peak wavelength	λ_p	---	940	---	nm	
High level output voltage	V_{OH}	$V_{CC}-0.4$	V_{CC}	---	V	Output open
Low level output voltage	V_{OL}	---	---	0.5	V	$I_{OUT} < 2.5\text{mA}$
Internal pull up resistor	R_{PU}	---	45	---	k Ω	
Max Reception range	L_{0max}	14	20	---	m	Test signal according to figure 2
	L_{45max}	7	10	---		
Min reception distance	L_{0min}	---	---	0.1		Output pulse width:
Half angle(horizontal)	φ_h	---	± 45	---	deg	$400\mu\text{s} < T_L < 800\mu\text{s}$
Half angle(vertical)	φ_v	---	± 45	---	deg	$400\mu\text{s} < T_H < 800\mu\text{s}$
Output low pulse	T_L	400	---	800	μs	See chapter test method,
Output high pulse	T_H	400	---	800	μs	

Note1: Absolute Maximum Ratings indicate limits beyond which damage to the device may occur.

Note2: 4mm from mold body for less than 5 seconds

Test method

The specified electro-optical characteristics are valid under the following conditions.

1. Measurement environment must be a place without extreme reflections
2. Transmitter radiant intensity $I_e = 80\text{mW/sr}$
3. External lighting contains LED lighting with a color temperature of 6000K and illumination at the IR receiver is less than 100lux ($E_v \leq 100\text{Lux}$)
4. Test signal as shown below in figure 3

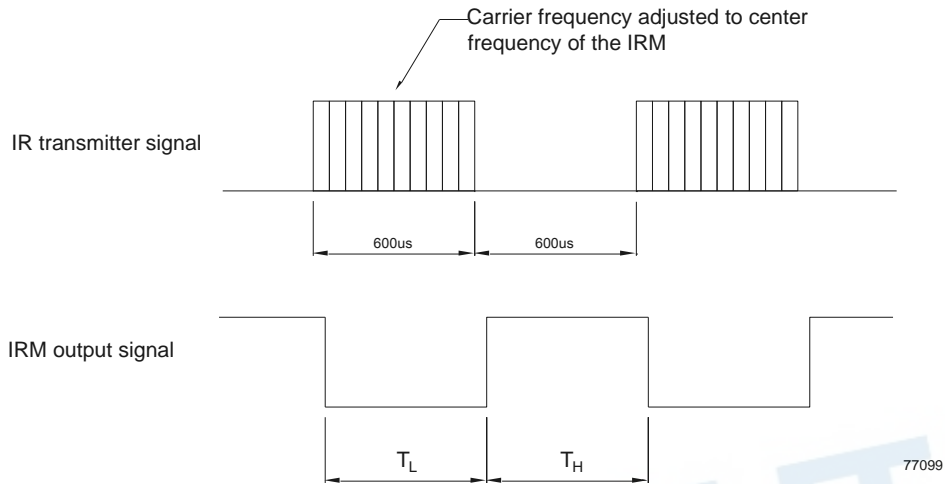

Fig.2 test signal and IRM output signal for reception distance and viewing angle test

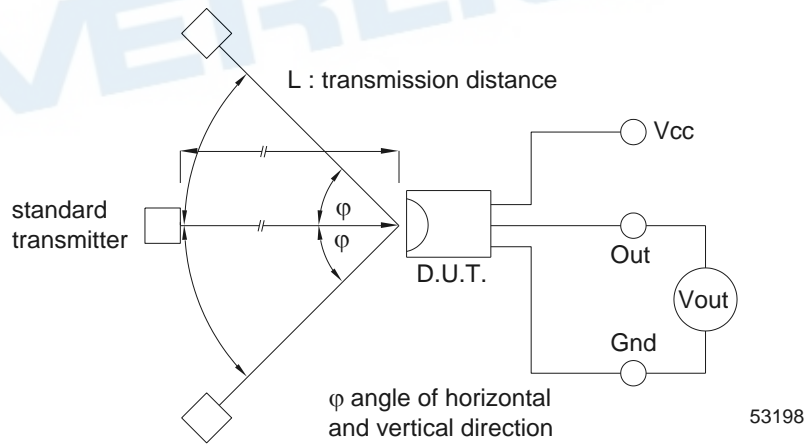

Fig.3 Measuring System

Typical Electro-Optical Characteristics Curves

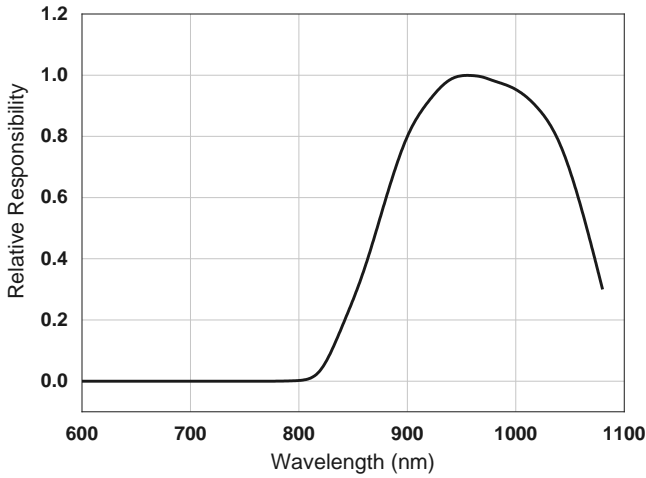

Fig. 4 Relative Responsibility vs. Wavelength

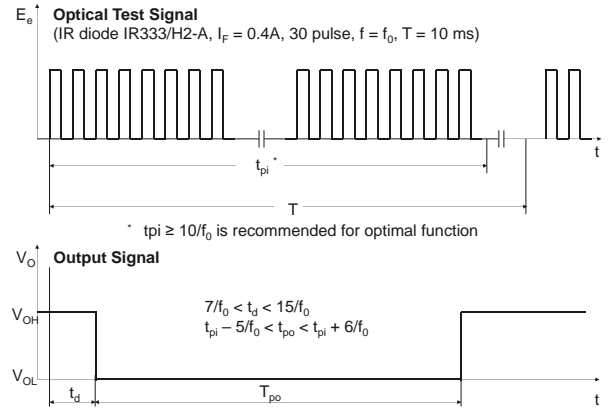

Fig. 5 IR Signal vs. Output Signal

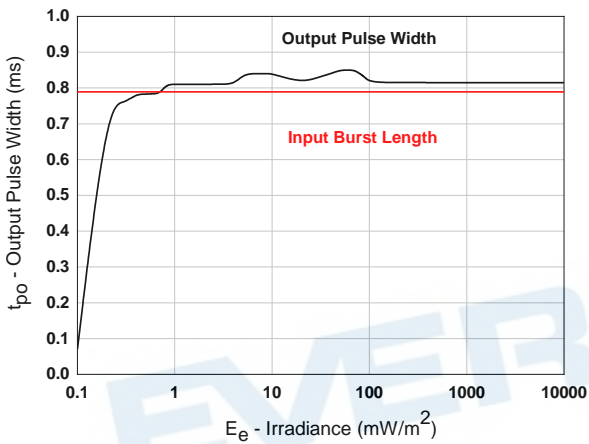

Fig. 6 Output Pulse Width and Sensitivity in Dark Ambient

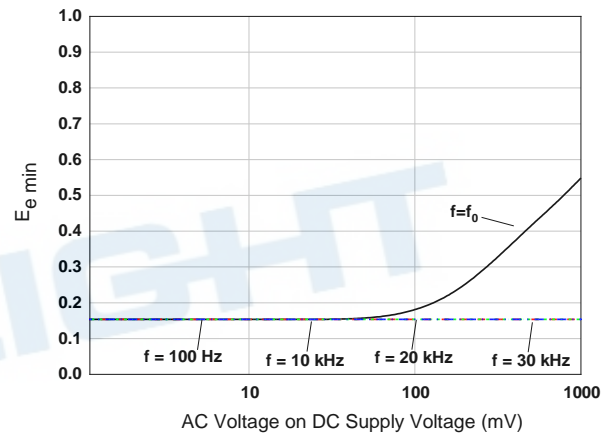

Fig. 7 $E_{e \min}$ vs. Supply Voltage Disturbances

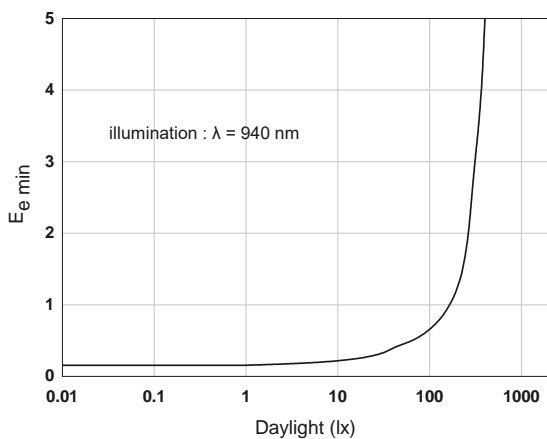

Fig. 8 Daylight vs. $E_{e \min}$.

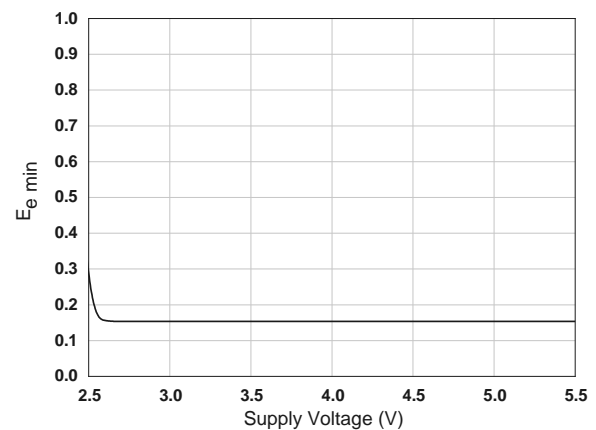

Fig. 9 $E_{e \min}$ vs. Supply Voltage

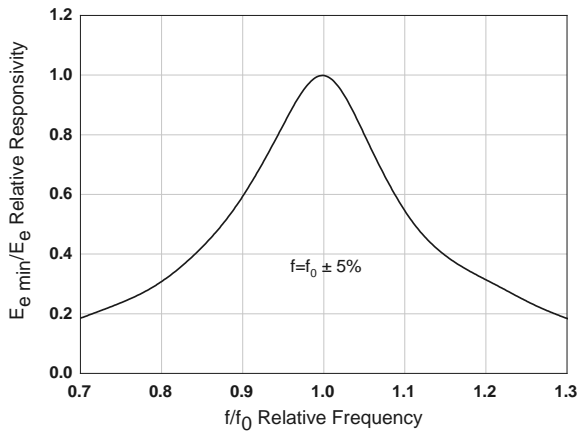

Fig. 10 Frequency Dependence of Responsivity

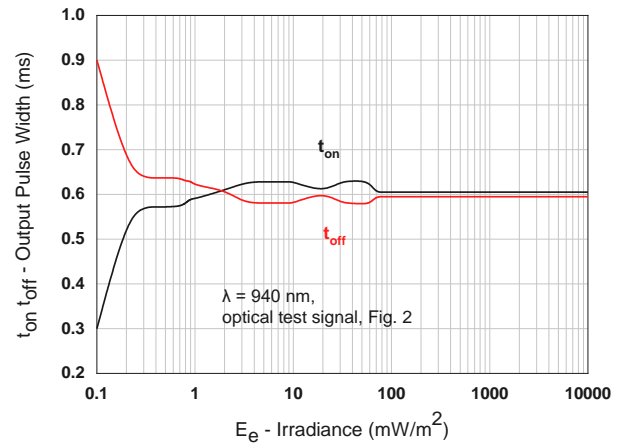

Fig. 11 Output Pulse Diagram

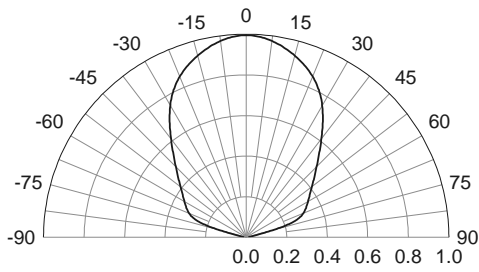

Fig. 12 Horizontal Directivity

EVERLIGHT

Application considerations

IRM IR receiver modules are high gain analog components to reach a long reception range. However, due to the high gain, they are also sensitive to noise from the power supply like V_{cc} ripple. Noise on the power supply can reduce the reception range of the IRM or cause output glitches and corrupted data. To protect the IRM receiver from power supply noise, a RC filter must be connected as close as possible to the V_{cc} and GND pins of the IRM. The circuit below in figure 9 shows the configuration of the RC filter and the required values. Ceramic or tantalum capacitor should be used, as standard electrolytic capacitors are only suitable for low frequencies and might not be able to filter noise in the frequency range of the IRM. The IRM receiver is most sensitive to noise which is at the carrier frequency or close to the carrier frequency. When using a switching mode power supply, the switching frequency must not be the same as the carrier frequency of the IRM. A gap of at least 20kHz between the switching frequency of the power supply and the IRM carrier frequency is recommended.

If the trace from the IRM output pin to the decoder IC on the PCB is long, the parasitic capacitance might be high causing slow rise times of the IRM output signal. In such case, an additional pull up resistor of 10kOhm or higher can be added at the IRM output to reduce the influence of parasitic trace capacitance.

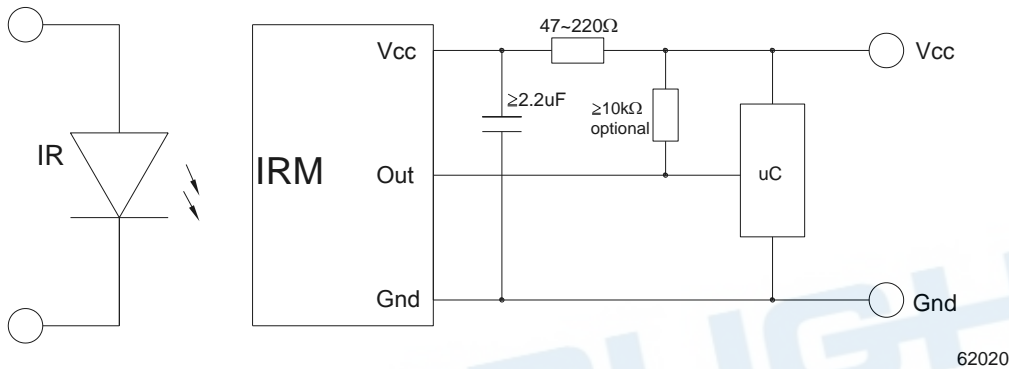

Fig.13: application circuit

Code compatibility

The IRM-36xxJ15 receiver modules are mainly designed for remote control applications which require very high noise immunity. Hence the IR code compatibility is matched for the most common IR protocols. To guarantee a proper data signal reception, a few points need to be taken into consideration.

The signal transmission must be carried out in data packages with limited length followed by a data pause time of a certain length. Continuous data transmission is not applicable as such kind of signal will be judged as noise and suppressed after a short time. Table1 below shows the compatibility to most commonly used IR protocols. If an IR protocol is not listed in this table, the compatibility needs to be checked according to the burst times, gap times, data package length and data pause time. The required limits for these items are shown in table 2 “acceptable IR signal timings”.

Protocol	Suitable	Protocol	Suitable	Protocol	Suitable
NEC	Yes	Toshiba	Yes	Sony 12 Bit	Yes
RC5	Yes	RCMM	No	Sony 15 Bit	No
RC6	Yes	Continuous	No	Sony 20 Bit	No

Table 1: IR protocol compatibility

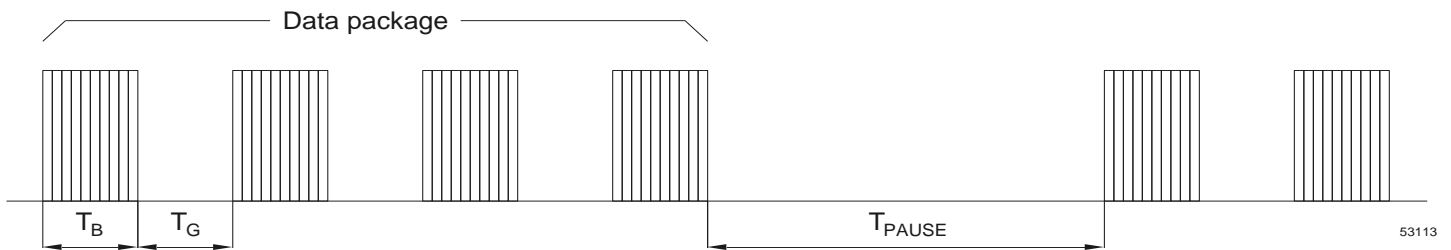

Fig.14: general IR data structure

	IRM-3636J15 IRM-3638J15 IRM-3640J15
Min. burst length T_B	300us
Min. gap length T_G	350us
Min. data pause time T_{PAUSE}	Min. 25ms
Required data pause time	$>(\text{Total word length} / 3) + 18.5\text{ms}$

Table 2: acceptable IR timings

Operation under noisy environment

The IRM-36xxJ15 receiver modules are designed for high light noise immunity, especially for noise from fluorescent and energy saving lamps and noise from TFT TVs with CCFL backlight. The receiver is able to suppress most optical noise, but the presence of any kind of optical noise will cause shorter reception range because the AGC will reduce the gain to suppress the noise.

The presence of noise can also affect the output pulse jitter. In such case, the output pulse jitter shown in the electro-optical specification above, might not be valid anymore and bigger pulse jitter can occur. This behavior needs to be considered when tuning the timing limits of the decoder. It is recommended to use the output pulse variation shown in the electro-optical specifications above as a base to set the timing limits of the decoder. However, due to different protocols and environmental conditions, other timing limits might result in better performance and decoding security.

This needs to be verified for the specific application by testing under different noise conditions.

Device Marking

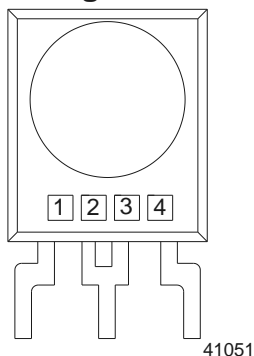

Notes

- 1 denotes Year code
- 2 denotes Month code
- 3 denotes Device number
- 4 denotes Carrier frequency

Package Dimensions

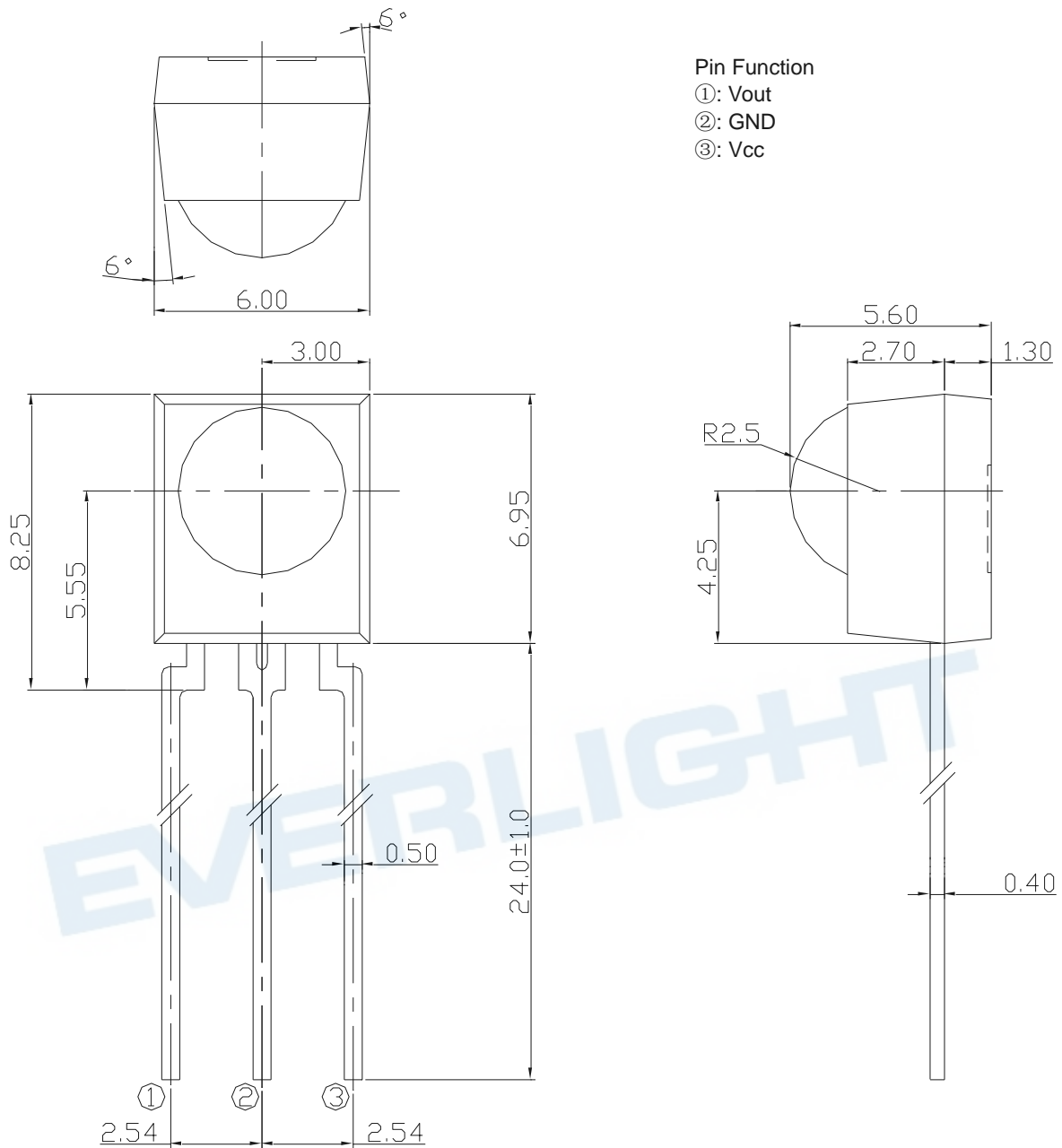

Notes:

1. All dimensions are in millimeters.
2. Tolerance unless otherwise mentioned is $\pm 0.5\text{mm}$

Packing Quantity

250 pcs / Bag
6 Bags / Box
10 Boxes / Carton

DISCLAIMER

1. EVERLIGHT reserves the right(s) on the adjustment of product material mix for the specification.
2. The product meets EVERLIGHT published specification for a period of twelve (12) months from date of shipment.
3. The graphs shown in this datasheet are representing typical data only and do not show guaranteed values.
4. When using this product, please observe the absolute maximum ratings and the instructions for using outlined in these specification sheets. EVERLIGHT assumes no responsibility for any damage resulting from the use of the product which does not comply with the absolute maximum ratings and the instructions included in these specification sheets.
5. These specification sheets include materials protected under copyright of EVERLIGHT. Reproduction in any form is prohibited without obtaining EVERLIGHT's prior consent.
6. This product is not intended to be used for military, aircraft, automotive, medical, life sustaining or life saving applications or any other application which can result in human injury or death. Please contact authorized Everlight sales agent for special application request.

EVERLIGHT

X-ON Electronics

Largest Supplier of Electrical and Electronic Components

Click to view similar products for [Infrared Receivers](#) category:

Click to view products by [Everlight](#) manufacturer:

Other Similar products are found below :

[TSOP6136TT](#) [TSOP2456](#) [TSOP31456](#) [TSOP38336](#) [TSOP53356](#) [ZSPD-Z3020B-29C-Z5](#) [IRM-3638JT](#) [IRM-3638J15](#) [IRM-3638J7](#) [DY-PT928-6C](#) [DY-PD204-6C-L3](#) [ZSIRM-Z3QN88P\(LXM\)](#) [ZSIRM-Z1QN86](#) [ZSIRM-Z3QN88P\(CG\)](#) [TSOP31140](#) [TSOP75238WTT](#) [RPM7238-H5R](#) [TSOP4156](#) [TSOP6156TR](#) [TSOP75338TR](#) [TSSP77038TT](#) [TSOP38138](#) [TSOP59438](#) [TSOP58336](#) [OSRB38C9AA](#) [TSOP75538WTT](#) [TSOP39336TR1](#) [TSOP75240TR](#) [TSOP75256TR](#) [TSOP53456](#) [TSOP75436TT](#) [TSOP53556](#) [TSOP75456TR](#) [TSOP37338TT1](#) [TSOP39338](#) [TSOP75256TT](#) [TSOP75336TR](#) [TSOP36156TT](#) [TSOP4838QJ1](#) [TSSP4038SS1XB](#) [TSOP39438TR1](#) [TSOP6133TR](#) [IS471FE](#) [PB11CNT15WR](#) [ZIRM-5042B-42-Z2](#) [IRM-3638M3F99-E80](#) [IRM-3638MF56](#) [DY-PT4133B-A2](#) [E6QYDD1204-PRA](#) [IRM-3636M3F45](#)