



Technical Data Sheet

OPTO INTERRUPTER ITR

ITR9907

■ Features

- Fast response time
- High sensitivity
- Cut-off visible wavelength $\lambda_p=940\text{nm}$
- Thin
- Small package
- Pb free
- The product itself will remain within RoHS compliant version.

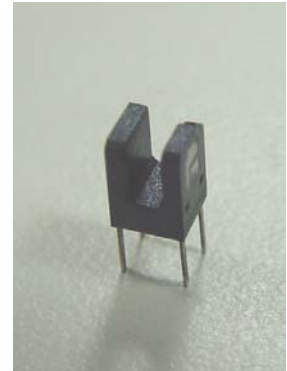

■ Descriptions

The **ITR9907** consists of an infrared emitting Diode and a silicon phototransistor encased in a black Thermo-plastic housing. The advantage of the device is the small package. Phototransistor receives radiation from the IRED only, and avoids the noise from ambient light

■ Applications

- Camera
- Copier
- Scanner
- Non-contact Switching
- For Direct PC Board

■ Device Selection Guide

Device No.	Chip Material
IR	GaAs
PT	Silicon

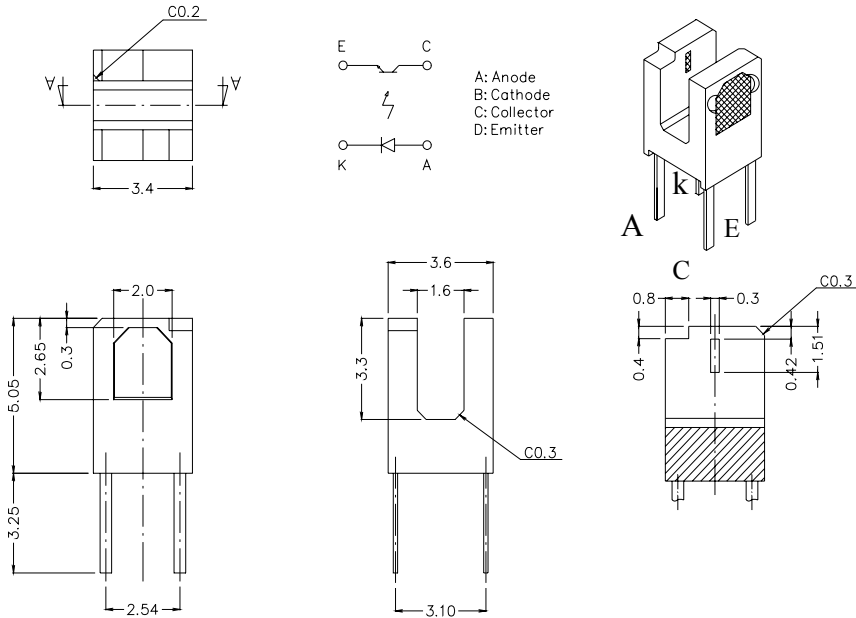
Package Dimensions

- Notes:** 1.All dimensions are in millimeters
 2.Tolerances unless dimensions $\pm 0.25\text{mm}$

Absolute Maximum Ratings (Ta=25°C)

Parameter		Symbol	Ratings	Unit
Input	Power Dissipation at(or below) 25°C Free Air Temperature	Pd	75	mW
	Reverse Voltage	V _R	5	V
	Forward Current	I _F	50	mA
	Peak Forward Current (*1) Pulse width $\leq 100 \mu\text{s}$, Duty cycle=1%	I _{FP}	1	A
Output	Collector Power Dissipation	P _C	75	mW
	Collector Current	I _C	20	mA
	Collector-Emitter Voltage	B V _{CEO}	30	V
	Emitter-Collector Voltage	B V _{ECO}	5	V
Operating Temperature		T _{opr}	-25~+85	°C
Storage Temperature		T _{stg}	-40~+85	°C
Lead Soldering Temperature (*2)		T _{sol}	260	°C

(*1) $t_w=100 \mu\text{sec.}$, $T=10 \text{msec.}$ (*2) $t=5 \text{Sec}$

Electro-Optical Characteristics (Ta=25°C)

Parameter		Symbol	Min.	Typ.	Max.	Unit	Conditions
Input	Forward Voltage	V_F	---	1.2	1.6	V	$I_F=20\text{mA}$
	Reverse Current	I_R	---	---	10	μA	$V_R=5\text{V}$
	Peak Wavelength	λ_P	---	940	---	nm	---
Output	Dark Current	I_{CEO}	---	---	100	nA	$V_{CE}=10\text{V}$
	C-E Saturation Voltage	$V_{CE}(\text{sat})$	---	---	0.4	V	$I_C=2\text{mA}$ $E_e=1\text{mW/cm}^2$
Transfer Characteristics	Collector Current	$I_C(\text{ON})$	50	---	---	μA	$V_{CE}=5\text{V}$, $I_F=5\text{mA}$
	Leakage Current	I_{CEOD}	---	---	1	μA	$V_{CE}=5\text{V}$ $I_F=20\text{mA}$
	Rise time	t_r	---	15	---	μsec	$V_{CE}=2\text{V}$ $I_C=1\text{mA}$ $R_L=1\text{K}\Omega$
	Fall time	t_f	---	15	---	μsec	

Typical Electrical/Optical/Characteristics Curves for IR

Fig.1 Forward Current vs. Ambient Temperature

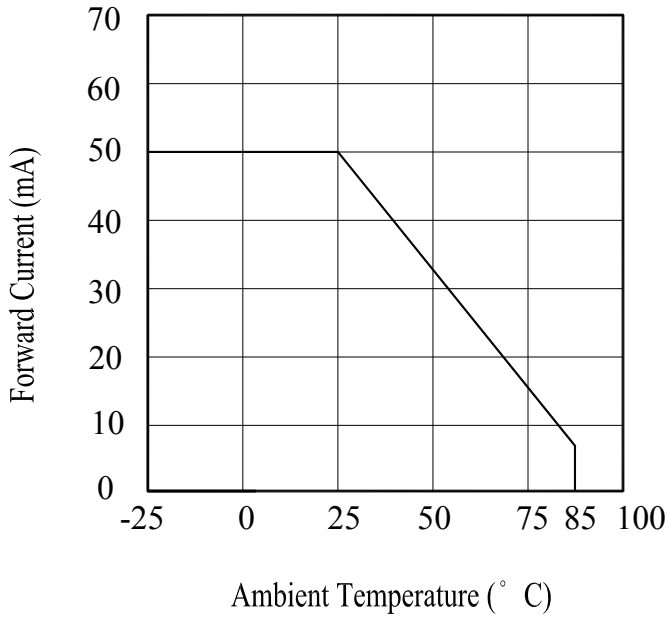

Fig.2 Spectral Distribution

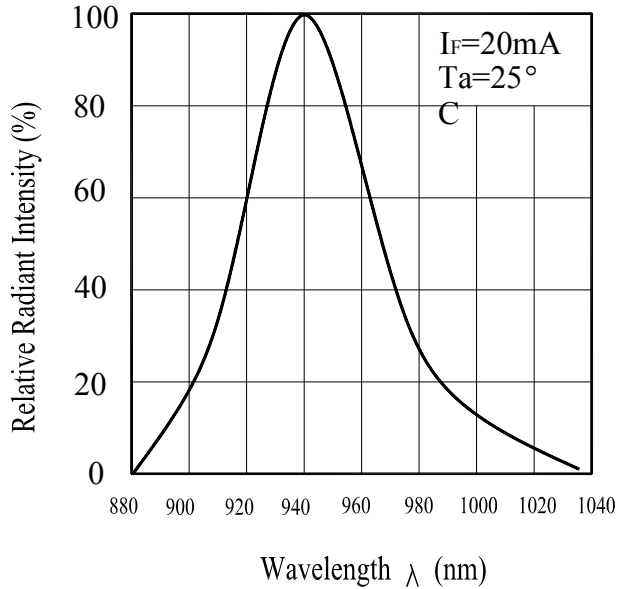

Fig.3 Peak Emission Wavelength vs. Ambient Temperature

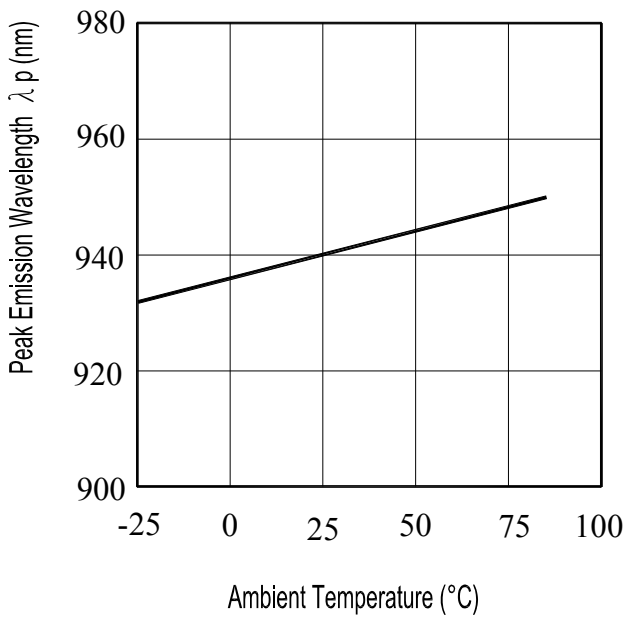

Fig.4 Forward Current vs. Forward Voltage

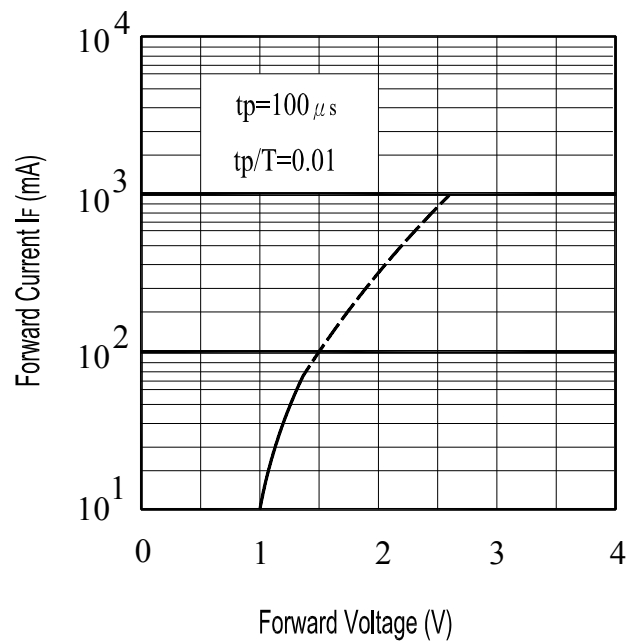

Fig.8 Forward Voltage vs. Ambient Temperature(°C)

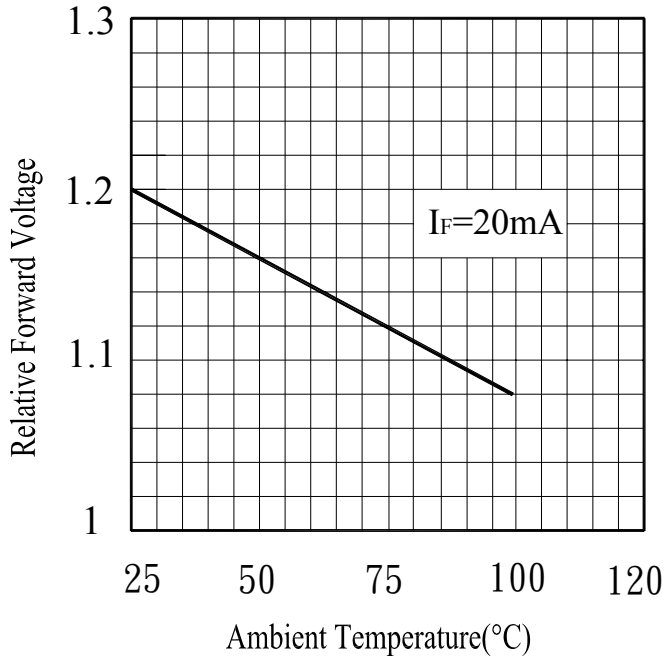
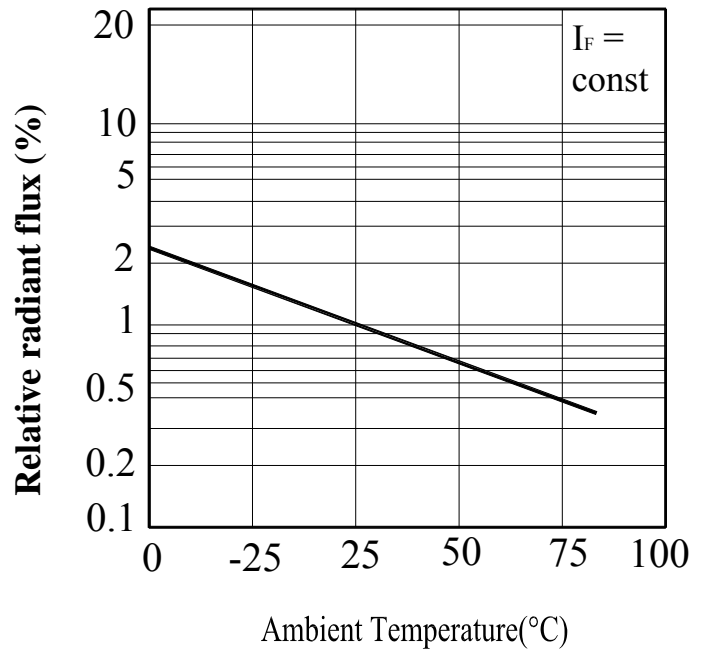

Fig.6 Relative Radiant Flux vs. Ambient Temperature(°C)



Typical Electrical/Optical/Characteristics Curves for PT

Fig.1 Collector Power Dissipation vs. Ambient Temperature

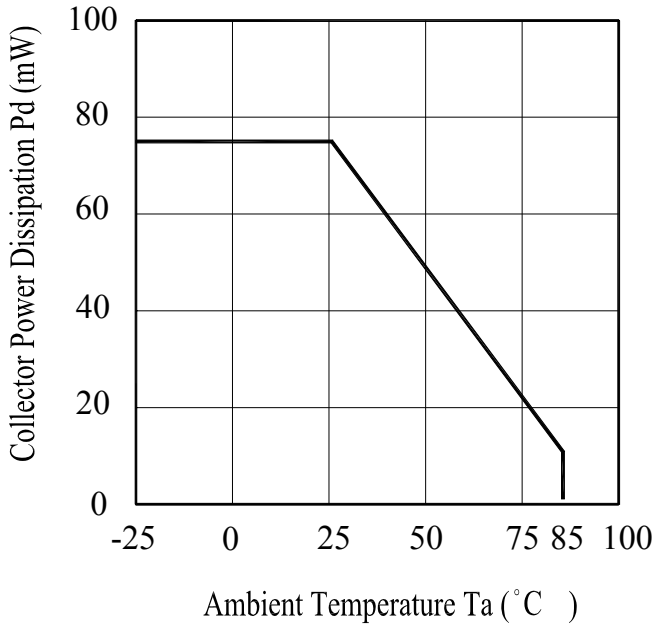

Fig.2 Spectral Sensitivity

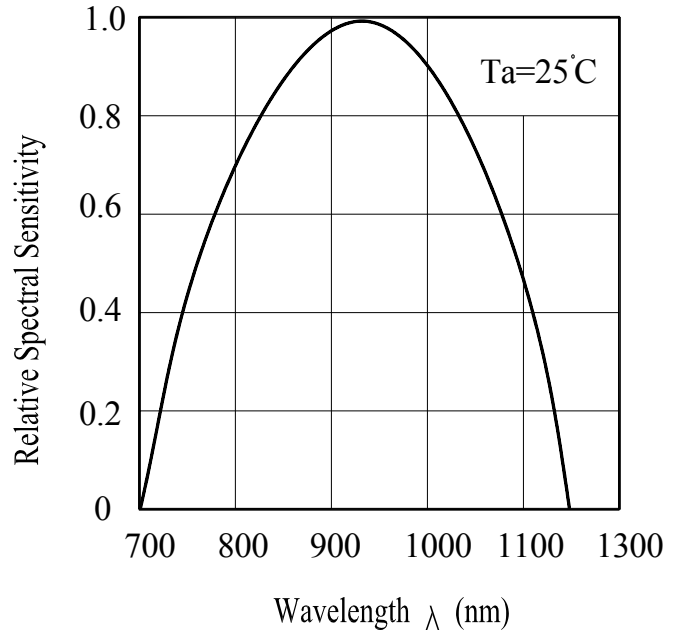

Fig.3 Relative Collector Current vs. Ambient Temperature

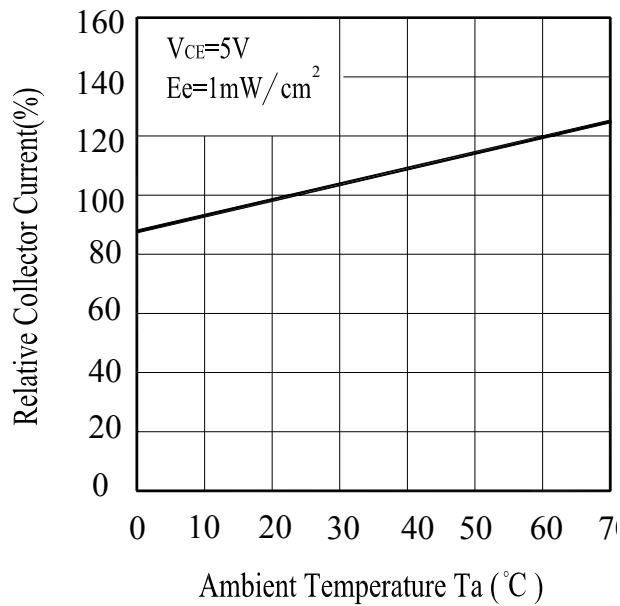
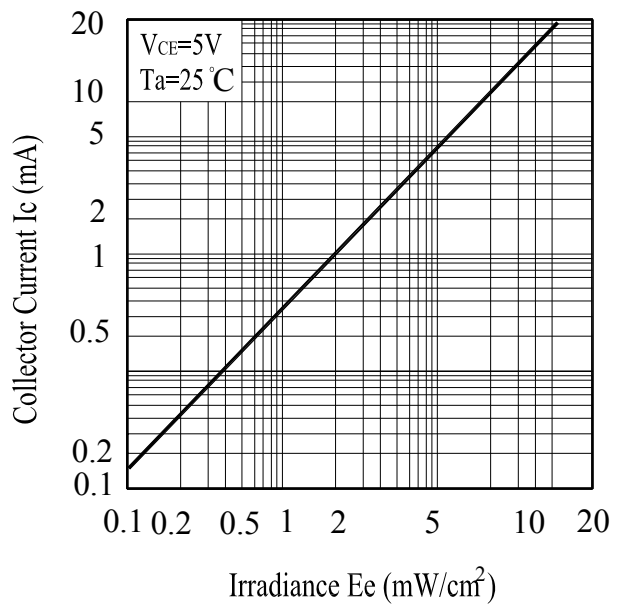

Fig.4 Collector Current vs. Irradiance



Typical Electro-Optical Characteristics Curves

Fig.5 Collector Dark Current vs. Ambient Temperature

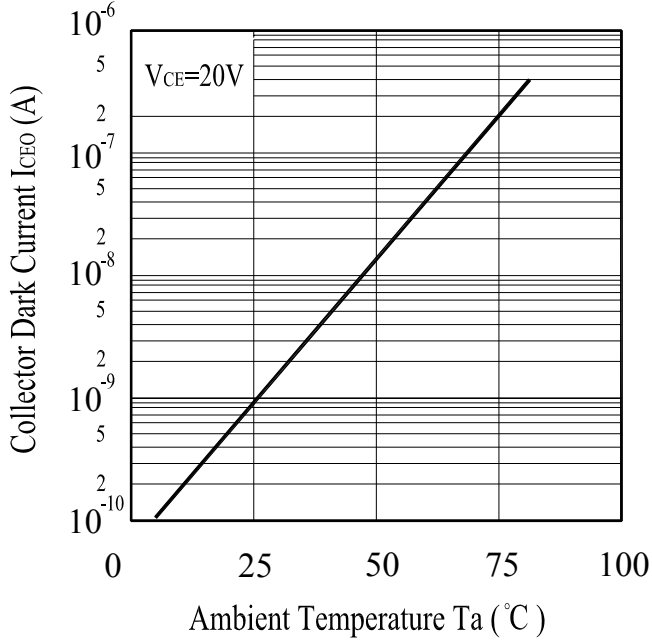
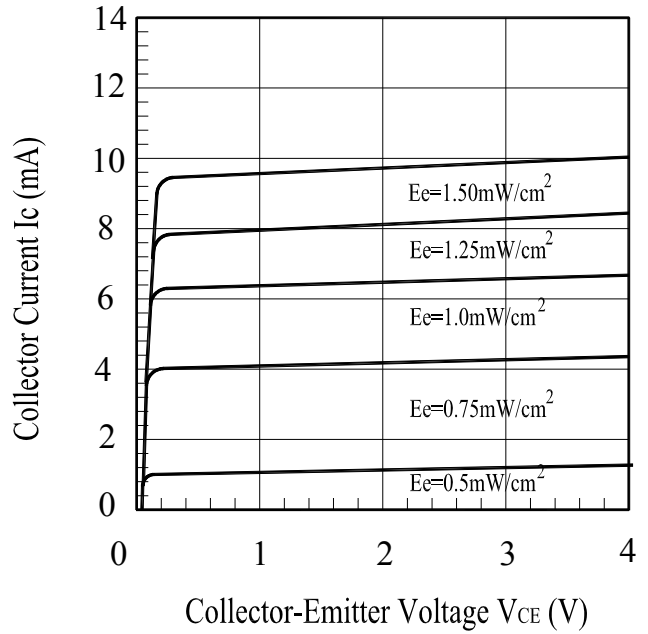

Fig.6 Collector Current vs. Collector-Emitter Voltage



Reliability Test Item And Condition

The reliability of products shall be satisfied with items listed below.

Confidence level : 90%

LTPD : 10%

NO.	Item	Test Conditions	Test Hours/ Cycles	Sample Sizes	Failure Judgement Criteria	Ac/Re
1	Solder Resistance	Ta = 260 ±3°C	10 ± 1 sec	22pcs		0/1
2	Temperature Cycle	H : +100°C 15mins ↕ 5mins L : -40°C 15mins	50Cycles	22pcs	IR ≥ U×2 Ee ≤ L×0.8 VF ≥ U×1.2	0/1
3	Thermal Shock	H : +100°C 5mins ↕ 10secs L : -10°C 5mins	50Cycles	22pcs	U : Upper Specification	0/1
4	High Temperature Storage	TEMP. : +100°C	1000hrs	22pcs	Limit L : Lower	0/1
5	Low Temperature Storage	TEMP. : -40°C	1000hrs	22pcs	Specification Limit	0/1
6	DC Operating Life	VCE=5V	1000hrs	22pcs		0/1
7	High Temperature/ High Humidity	85°C / 85% R.H	1000hrs	22pcs		0/1

X-ON Electronics

Largest Supplier of Electrical and Electronic Components

Click to view similar products for [Optical Switches, Reflective, Phototransistor Output](#) *category:*

Click to view products by [Everlight](#) *manufacturer:*

Other Similar products are found below :

[HOA1180-106](#) [NJL5303R-TE1](#) [RPR-359F](#) [KTIR0711S](#) [OPB70HWZ](#) [OPR5005](#) [EE-SF5-B](#) [ITR8307](#) [755N](#) [ITR-20001T](#) [ITR-20002](#)
[ITR20005](#) [ITR20403](#) [ITR-8307/TR8](#) [ITR9606-F](#) [ITR9608](#) [ITR9702-F](#) [ITR9707](#) [ITR-9904](#) [ITR9908](#) [ITR-9909](#) [HOA0708-001](#) [HOA0709-](#)
[001](#) [HOA0709-011](#) [HOA1180-001](#) [HOA1180-002](#) [HOA1397-001](#) [HOA1397-002](#) [HOA1406-003](#) [HOA2498-002](#) [ITR8307/L24/TR8](#)
[ITR9608-F](#) [KTIR0721DS](#) [LTH-209-01](#) [LTH-1550-01](#) [MTRS9520](#) [MTRS1070](#) [NJL5501R-TE1](#) [NJL5902R-2-TE1](#) [EE-SB5](#) [EE-SB5-B](#)
[EESB5VE](#) [EE-SF5](#) [EE-SPY301](#) [EE-SPY302](#) [EE-SPY311](#) [EE-SPY312](#) [EE-SPY401](#) [EE-SPY402](#) [EE-SPY411](#)