

SUPER BRIGHT T-100 (3 mm) LED LAMP

PACKAGE DIMENSIONS

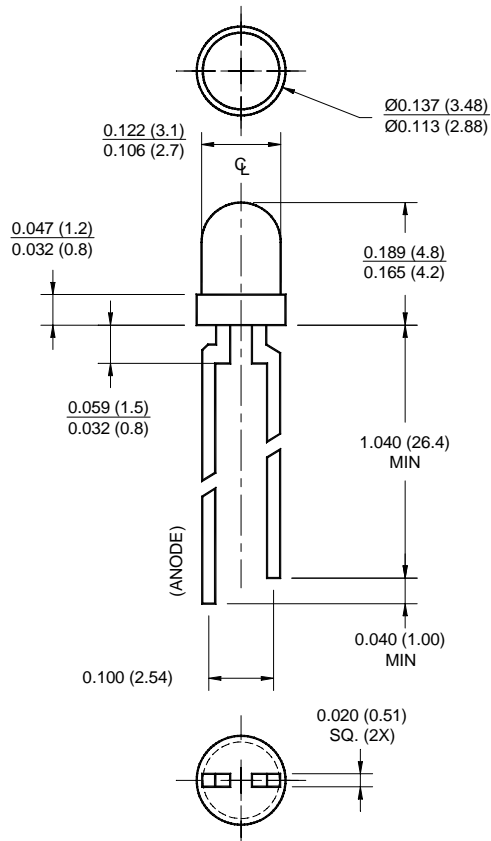

NOTES:

1. Dimensions for all drawings are in inches (mm).
2. Lead spacing is measured where the leads emerge from the package.
3. Protruded resin under the flange is 1.5 mm (0.059") max.

SUPER BLUE (WATER CLEAR)
SUPER BLUE (BLUE DIFFUSED)

MV5B60
MV5B640

FEATURES

- Low drive current
- Solid state reliability
- Water clear or blue diffused optics
- Standard 100 mil. lead spacing

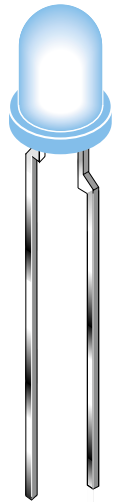

DESCRIPTION

These T-100 super bright blue LEDs have a moderate viewing angle of 35° or 45° for concentrated light output. The blue diode chip is constructed with GaN/SiC technology and emits a peak wavelength of 430 nm.

ABSOLUTE MAXIMUM RATINGS (T_A = 25°C unless otherwise specified)

Parameter	Symbol	Rating	Unit
Operating Temperature	T _{OPR}	-40 to +100	°C
Storage Temperature	T _{STG}	-40 to +100	°C
Lead Soldering Time	T _{SOL}	260 for 5 sec	°C
Continuous Forward Current	I _F	30	mA
Peak Forward Current (f = 1.0 KHz, Duty Factor = 1/10)	I _F	100	mA
Reverse Voltage (I _R = 10 μA)	V _R	5	V
Power Dissipation	P _D	120	mW

SUPER BLUE (WATER CLEAR)	MV5B60
SUPER BLUE (BLUE DIFFUSED)	MV5B640

ELECTRICAL / OPTICAL CHARACTERISTICS (T_A = 25°C)

Part Number	MV5B60	MV5B640	Condition
Luminous Intensity (mcd)			I _F = 20 mA
Minimum	100	60	
Typical	150	100	
Forward Voltage (V)			I _F = 20 mA
Maximum	4.5	4.5	
Typical	3.8	3.8	
Peak Wavelength (nm)	430	430	I _F = 20 mA
Spectral Line Half Width (nm)	65	65	I _F = 20 mA
Viewing Angle (°)	35	45	I _F = 20 mA

TYPICAL PERFORMANCE CURVES

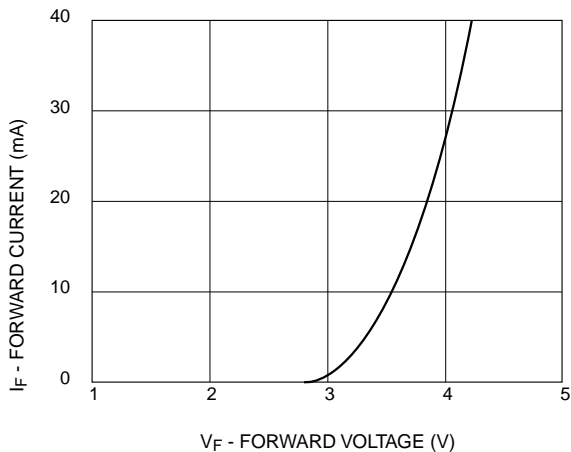

Fig.1 Forward Current vs. Forward Voltage

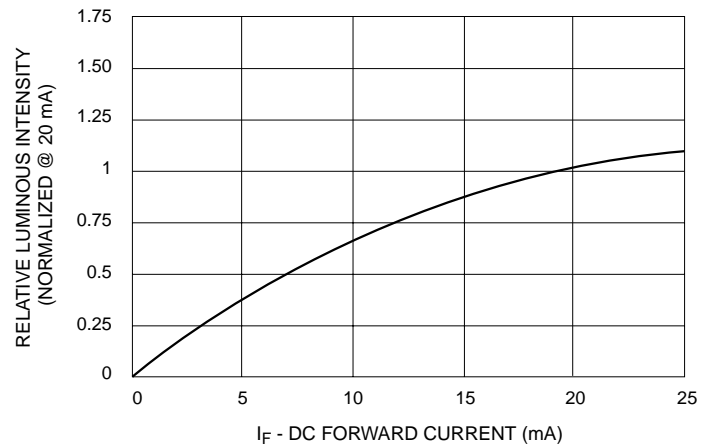

Fig.2 Relative Luminous Intensity vs. DC Forward Current

SUPER BLUE (WATER CLEAR)	MV5B60
SUPER BLUE (BLUE DIFFUSED)	MV5B640

TYPICAL PERFORMANCE CURVES

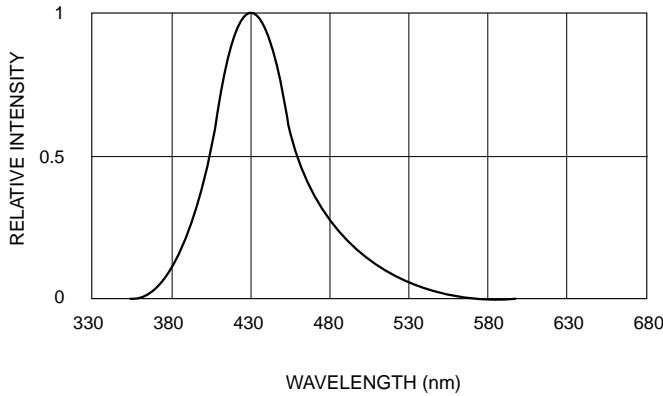

Fig. 3 Relative Intensity vs. Peak Wavelength

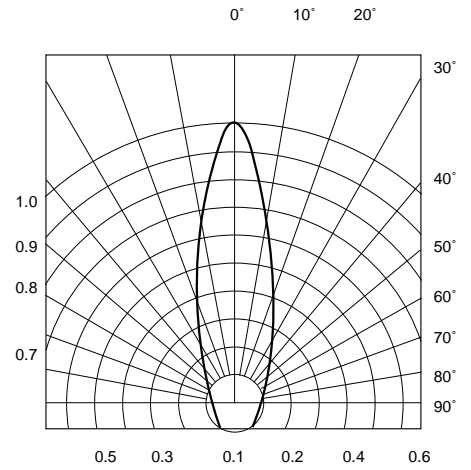

Fig. 4a Radiation Diagram for MV5B60

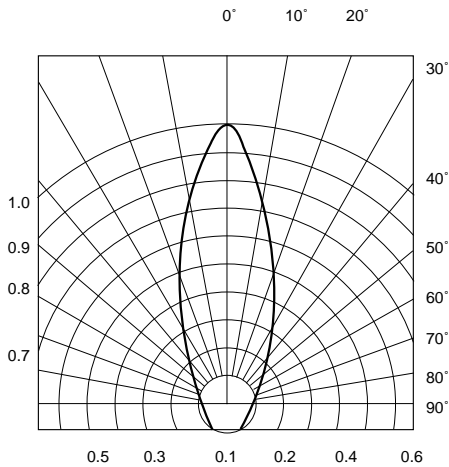

Fig. 4b Radiation Diagram for MV5B640

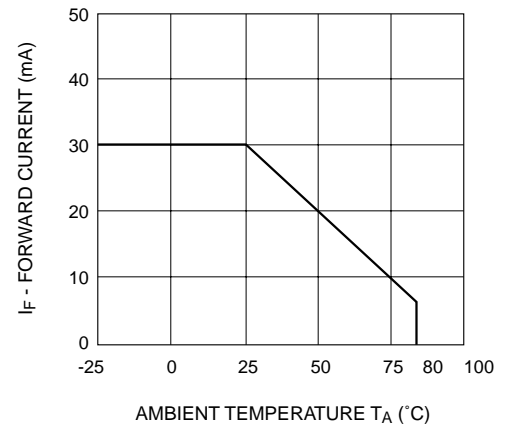

Fig. 5 Current Derating Curve

DISCLAIMER

FAIRCHILD SEMICONDUCTOR RESERVES THE RIGHT TO MAKE CHANGES WITHOUT FURTHER NOTICE TO ANY PRODUCTS HEREIN TO IMPROVE RELIABILITY, FUNCTION OR DESIGN. FAIRCHILD DOES NOT ASSUME ANY LIABILITY ARISING OUT OF THE APPLICATION OR USE OF ANY PRODUCT OR CIRCUIT DESCRIBED HEREIN; NEITHER DOES IT CONVEY ANY LICENSE UNDER ITS PATENT RIGHTS, NOR THE RIGHTS OF OTHERS.

LIFE SUPPORT POLICY

FAIRCHILD'S PRODUCTS ARE NOT AUTHORIZED FOR USE AS CRITICAL COMPONENTS IN LIFE SUPPORT DEVICES OR SYSTEMS WITHOUT THE EXPRESS WRITTEN APPROVAL OF THE PRESIDENT OF FAIRCHILD SEMICONDUCTOR CORPORATION. As used herein:

1. Life support devices or systems are devices or systems which, (a) are intended for surgical implant into the body, or (b) support or sustain life, and (c) whose failure to perform when properly used in accordance with instructions for use provided in the labeling, can be reasonably expected to result in a significant injury of the user.
2. A critical component in any component of a life support device or system whose failure to perform can be reasonably expected to cause the failure of the life support device or system, or to affect its safety or effectiveness.

X-ON Electronics

Largest Supplier of Electrical and Electronic Components

Click to view similar products for [Standard LEDs - Through Hole category](#):

Click to view products by [Everlight manufacturer](#):

Other Similar products are found below :

[LTL-10254W](#) [LTL-1214A](#) [LTL-2231AT](#) [LTL-3251A](#) [LTL-4262N](#) [LTL-433P](#) [LTL-5234](#) [LTL87HTBK](#) [LTX-87HD4B](#) [HLMP-EL30-PS0DD](#) [1L0532V23G0TD001](#) [NSPW500CS](#) [LD CQDP-1U3U-W5-1-K](#) [LP379PPG1C0G0300001](#) [SLR-342MC3F](#) [SLX-LX3044GD](#) [SLX-LX3044ID](#) [SLX-LX3044YD](#) [1.90690.3330000](#) [SSS-LX4673ID-410B](#) [1L0532Y24I0TD001](#) [264-7SYGD/S530-E2](#) [HLMP-1301-G00FG](#) [HLMP1385](#) [LTL-10224W](#) [LTL-1224A](#) [LTL-1234A](#) [LTL-2251AT](#) [LTL-403HR](#) [LTL-4222](#) [LU7-E-B](#) [4380H1](#) [HLMP-3962-F0002](#) [HLMP-GG15-R0000](#) [323-2SURD/S530-A3](#) [L53SRC/E-Z](#) [L-7679C1ZGC](#) [4302T1-5V](#) [4306D23](#) [4363D1/5](#) [WP1503SRC/J4](#) [WP153YDT](#) [WP1543SGC](#) [WP1543SURC](#) [WP53MGD](#) [WP7113HD](#) [WP7113MBD](#) [WP7113MGC](#) [WP7143SEC/H](#) [Z-221A](#)