

## Silicon Planar PIN Photodiode

### PD70-01C/TR7



#### Features

- High sensitivity
- Low capacitance
- Short switching time
- Wide temperature range
- Small package
- Pb free
- The product itself will remain within RoHS compliant version.
- Compliance with EU REACH.
- Compliance Halogen Free .(Br <900 ppm ,Cl <900 ppm , Br+Cl < 1500 ppm).

#### Descriptions

- The PD70-01C/TR7 is high sensitivity, fast switching times, low capacitance, compact size, and lack of measurable degradation make it suitable for diverse applications, such as TV and appliance remote control, IR sound transmission, video recorders, and measurement and control.

#### Applications

- High speed photo detector
- Copier
- Elevator

#### Device Selection Guide

Part Category	Chip Material	Lens Color
PD	Silicon	Water clear

### Package Dimensions

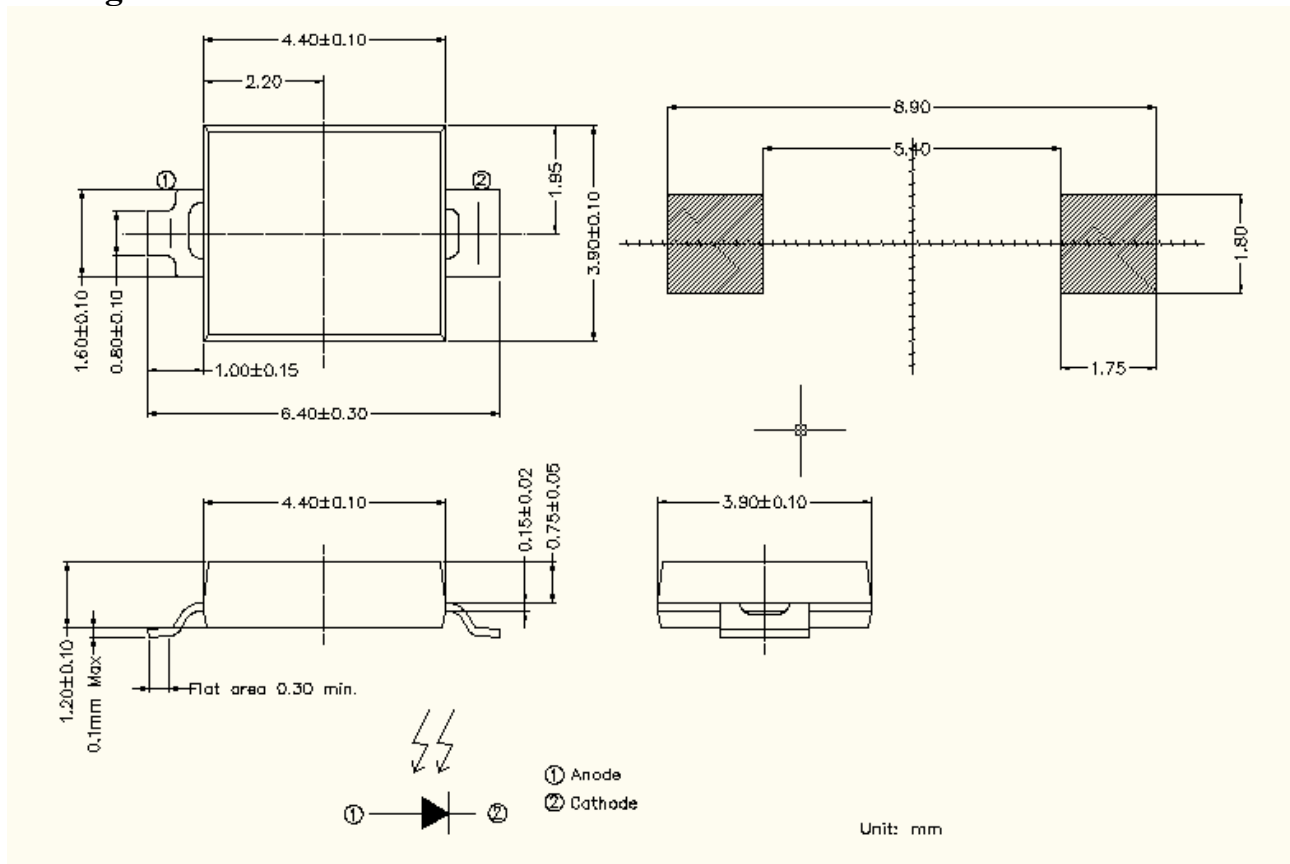

- Notes:** 1.All dimensions are in millimeters  
2.Tolerances unless dimensions  $\pm 0.1$ mm

### Absolute Maximum Ratings ( $T_a=25^\circ\text{C}$ )

Parameter	Symbol	Rating	Units
Reverse Voltage	$V_R$	32	V
Operating Temperature	$T_{opr}$	-25 ~ +85	$^\circ\text{C}$
Storage Temperature	$T_{stg}$	-40 ~ +85	$^\circ\text{C}$
Soldering Temperature *1	$T_{sol}$	260	$^\circ\text{C}$
Power Dissipation at(or below) 25 $^\circ\text{C}$ Free Air Temperature	$P_d$	150	mW

**Notes:** \*1:Soldering time  $\leq 5$  seconds.

**Electro-Optical Characteristics (Ta=25°C)**

Parameter	Symbol	Condition	Min	Typ	Max	Unit
Rang Of Spectral Bandwidth	$\lambda_{0.5}$	---	400	---	1100	nm
Wavelength Of Peak Sensitivity	$\lambda_p$	---	---	940	---	nm
Short- Circuit Current	$I_{SC}$	Ee=1mW/cm <sup>2</sup> $\lambda_p=875\text{nm}$	---	35	---	$\mu\text{A}$
Reverse Light Current	$I_L$	Ee=1mW/cm <sup>2</sup> $\lambda_p=875\text{nm}$ $V_R=5\text{V}$	17	25	---	$\mu\text{A}$
Reverse Dark Current	$I_D$	Ee=0mW/cm <sup>2</sup> $V_R=10\text{V}$	---	5	30	nA
Reverse Breakdown Voltage	$V_{BR}$	Ee=0mW/cm <sup>2</sup> $I_R=100\mu\text{A}$	32	170	---	V
Temperature coefficient of $V_{oc}$	$TK_{V_{oc}}$	Ee=1mW/cm <sup>2</sup> $\lambda_p=940\text{nm}$	---	-2.6	---	mV/K
Temperature coefficient of $I_{sc}$	$TK_{I_{sc}}$	Ee=1mW/cm <sup>2</sup> $\lambda_p=940\text{nm}$	---	-0.1	---	%/K

### Typical Electro-Optical Characteristics Curves

Fig.1 Spectral Sensitivity

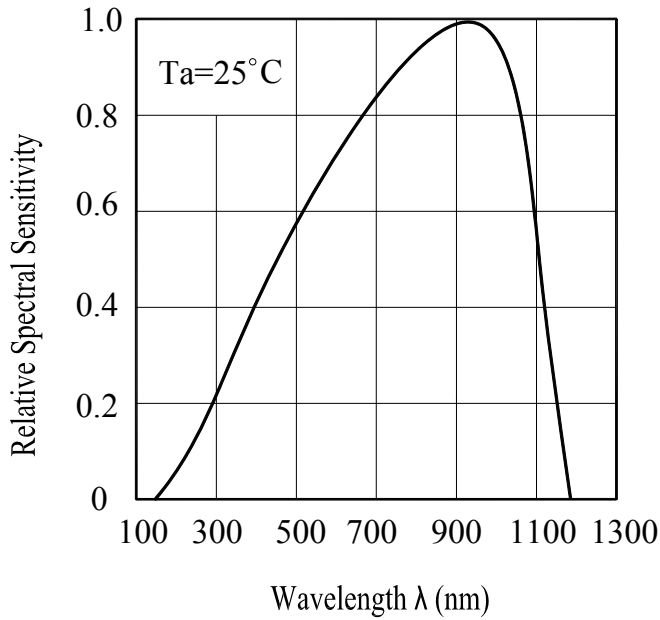
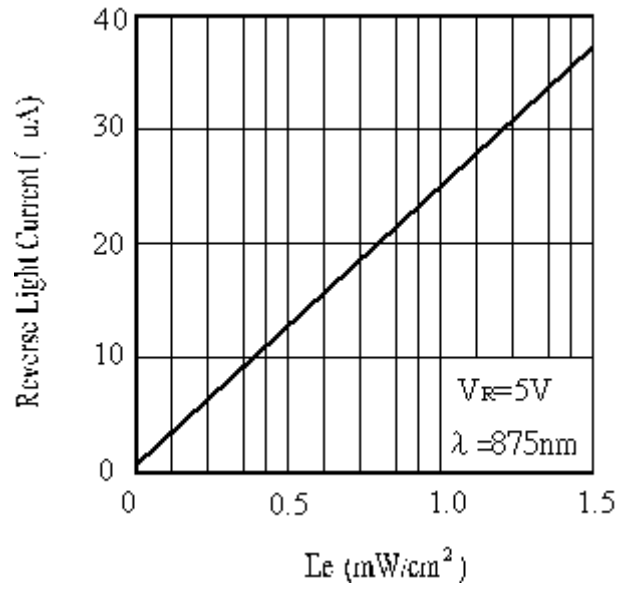

Fig. 2 Reverse Light Current vs.  $E_e$



## Precautions For Use

### 1. Over-current-proof

Customer must apply resistors for protection , otherwise slight voltage shift will cause big current change ( Burn out will happen ).

### 2. Storage

2.1 Do not open moisture proof bag before the products are ready to use.

2.2 Before opening the package, the PHOTODIODEs should be kept at 30°C or less and 90%RH or less.

2.3 The PHOTODIODEs should be used within a year.

2.4 After opening the package, the PHOTODIODEs should be kept at 30°C or less and 60%RH or less.

2.5 The PHOTODIODEs should be used within 168 hours (7 days) after opening the package.

2.6 If the moisture absorbent material (silica gel) has faded away or the PHOTODIODEs have exceeded the storage time, baking treatment should be performed using the following conditions.

Baking treatment : 60±5°C for 24 hours.

### 3. Soldering Condition

#### 3.1 Pb-free solder temperature profile

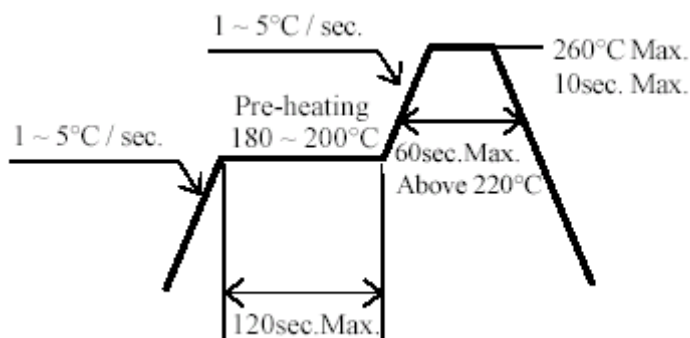

3.2 Reflow soldering should not be done more than two times.

3.3 When soldering, do not put stress on the PHOTODIODEs during heating.

3.4 After soldering, do not warp the circuit board.

#### 4.Soldering Iron

Each terminal is to go to the tip of soldering iron temperature less than 350°C for 3 seconds within once in less than the soldering iron capacity 25W. Leave two seconds and more intervals, and do soldering of each terminal. Be careful because the damage of the product is often started at the time of the hand solder.

#### 5.Repairing

Repair should not be done after the PHOTODIODEs have been soldered. When repairing is unavoidable, a double-head soldering iron should be used (as below figure). It should be confirmed beforehand whether the characteristics of the PHOTODIODEs will or will not be damaged by repairing.

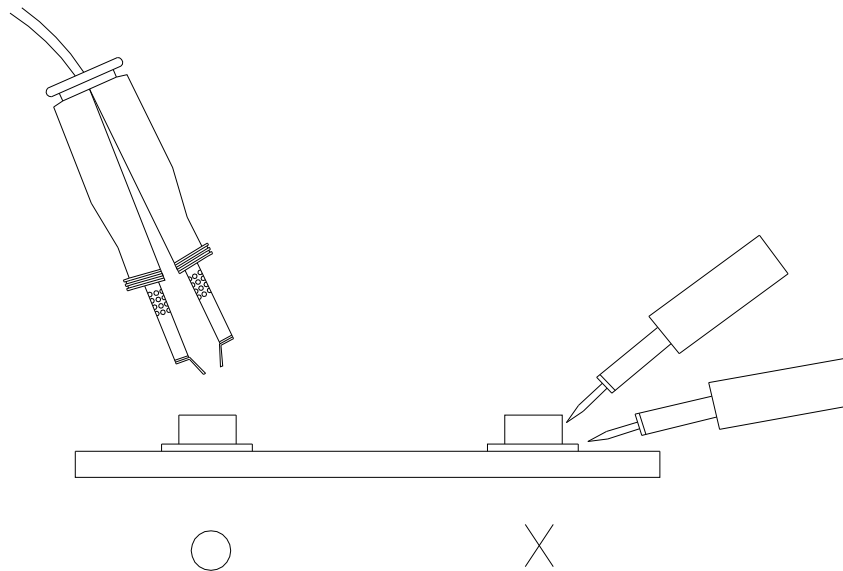

**Package Dimensions**

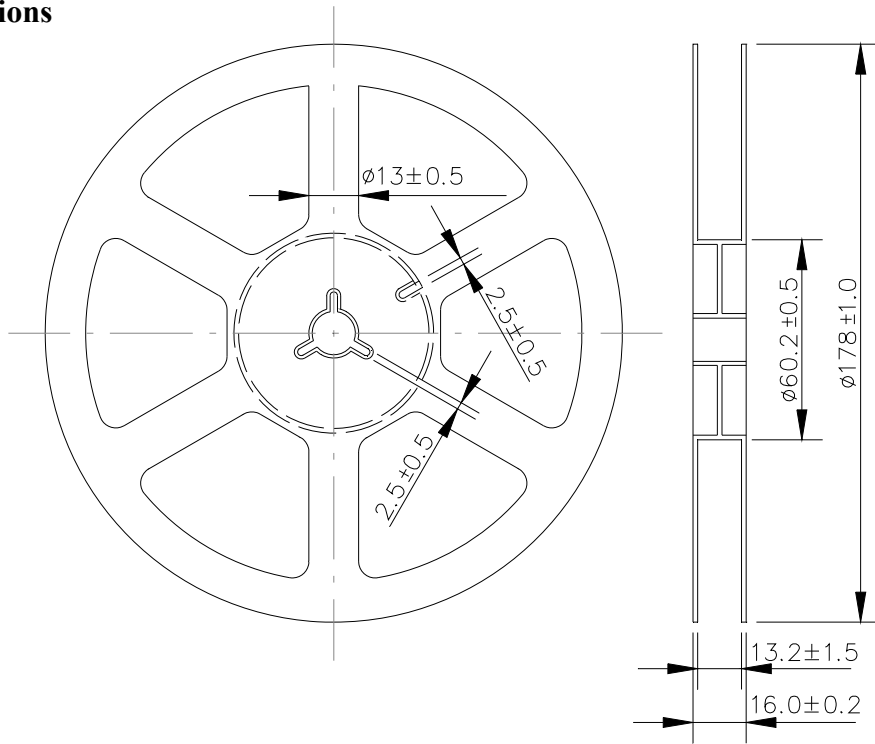

**Note:** The tolerances unless mentioned are  $\pm 0.1$ , unit=mm.

**Carrier Tape Dimensions: (Quantity: 1000PCS/Reel)**

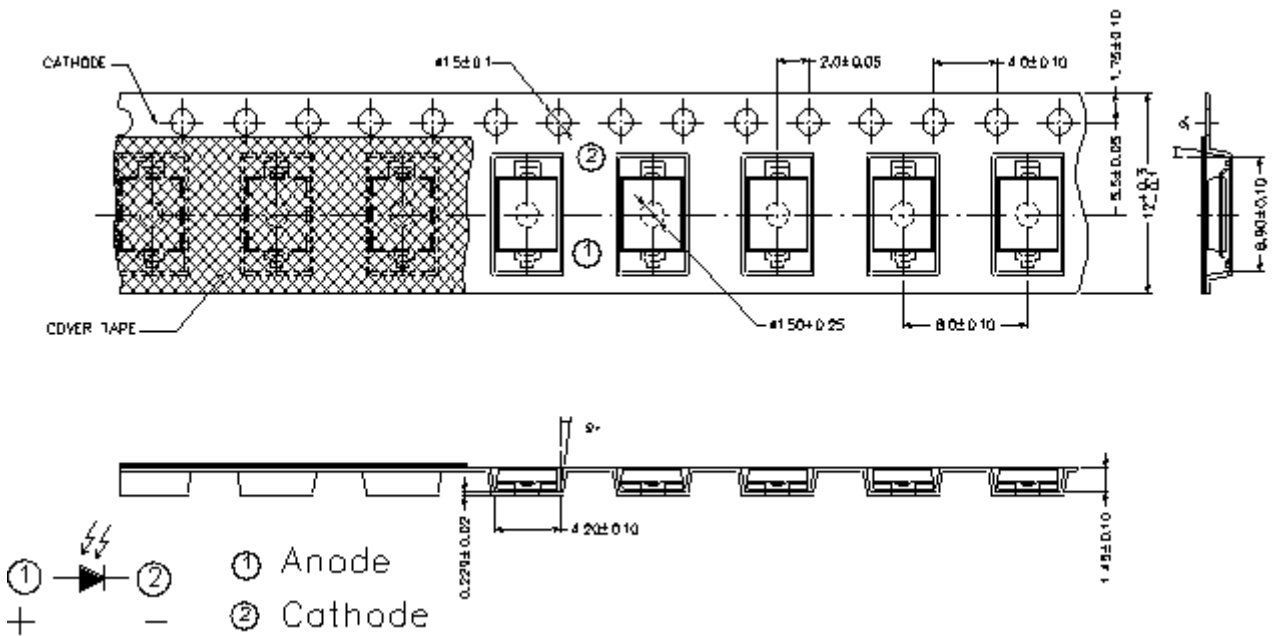

**Note:** The tolerances unless mentioned are  $\pm 0.1$ , unit=mm.

## Label Form Specification

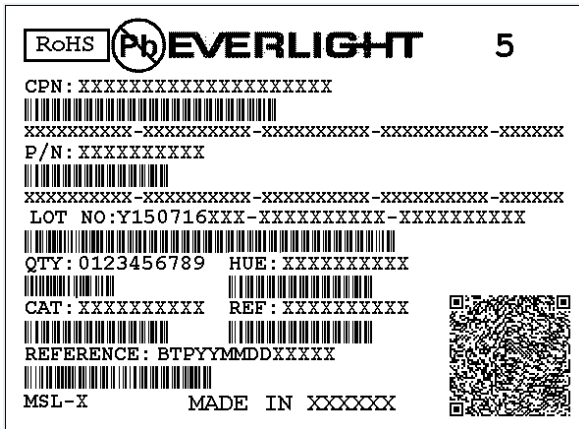

CPN: Customer's Production Number

P/N : Production Number

QTY: Packing Quantity

CAT: Ranks

HUE: Peak Wavelength

REF: Reference

LOT No: Lot Number

## DISCLAIMER

1. EVERLIGHT reserves the right(s) on the adjustment of product material mix for the specification.
2. The product meets EVERLIGHT published specification for a period of twelve (12) months from date of shipment.
3. The graphs shown in this datasheet are representing typical data only and do not show guaranteed values.
4. When using this product, please observe the absolute maximum ratings and the instructions for using outlined in these specification sheets. EVERLIGHT assumes no responsibility for any damage resulting from the use of the product which does not comply with the absolute maximum ratings and the instructions included in these specification sheets.
5. These specification sheets include materials protected under copyright of EVERLIGHT. Reproduction in any form is prohibited without obtaining EVERLIGHT's prior consent.
6. This product is not intended to be used for military, aircraft, automotive, medical, life sustaining or life saving applications or any other application which can result in human injury or death. Please contact authorized Everlight sales agent for special application request.



## X-ON Electronics

Largest Supplier of Electrical and Electronic Components

*Click to view similar products for [Photodiodes](#) category:*

*Click to view products by [Everlight](#) manufacturer:*

Other Similar products are found below :

[LTR-526AD](#) [OED-SP-7L](#) [LTR-536AB](#) [LTR-743DBM1-TA](#) [67-21SYGC-S349-TR8](#) [SFH 2200 A01](#) [HFD3081-108-XBA](#) [BPW 34 S E9601](#)  
[SFH 2713](#) [SFH 2703](#) [LTR-546AD](#) [BPV23FL](#) [BPW 34 FAS](#) [BPW 34 FS](#) [IG17X1000S4I](#) [IG22X250S4I](#) [VTD205H](#) [VTD205KH](#)  
[VTP1220FBH](#) [VTP1232FH](#) [VTP4085H](#) [SFH 2400](#) [OP913WSL](#) [OPF794](#) [PD70-01C/TR7](#) [LTR-536AD](#) [VTP8651H](#) [VTD206KH](#) [VTB1013H](#)  
[BPV23NF](#) [OP905](#) [LTR-516AD](#) [BPW 34 FS-Z](#) [VTD34FH](#) [SFH 2500 FA](#) [SFH 213 FA](#) [PD15-22C/TR8](#) [VEMD5510C](#) [SFH 2200](#)  
[VEMD5510CF](#) [APS5130PD7C-P22](#) [SAH230M](#) [SAH230M2](#) [SAH500M2](#) [BP 104 FS](#) [BPV22F-AS12](#) [BPW 21](#) [BPW 34 SR-Z](#) [BPX 65](#)  
[HSDL-5400#011](#)