

QTLP600C-R Red

QTLP600C-E Orange

QTLP600C-O Yellow-Orange

QTLP600C-Y Yellow

QTLP600C-AG Yellow-Green

QTLP600C-IG True Green

QTLP600C-IB Blue

PACKAGE DIMENSIONS

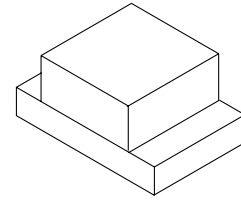
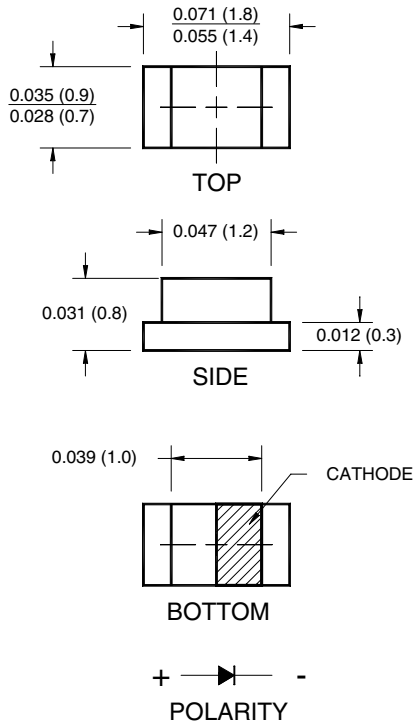

NOTE:

Dimensions for all drawings are in inches (mm).

APPLICATIONS

- Keypad backlighting
- Push-button backlighting
- LCD backlighting

DESCRIPTION

These surface mount chip LEDs are designed to fit industry standard footprint. Small size, low profile and wide viewing angle make these LEDs ideal choices for backlighting applications and panel illumination.

FEATURES

- Small footprint - 1.6(L) X 0.8(W) X 0.8(H) mm
- AllInGaP technology for -R, -E, -O, -Y and -AG
- InGaN/SiC technology for -IG and -IB
- Wide viewing angle of 100°
- Water clear optics
- Moisture-proof packaging
- Available in 0.315" (8mm) width tape on 7" (178mm) diameter reel; 2,000 units per reel

SURFACE MOUNT LED LAMP SUPER BRIGHT 0603 (0.8 mm Height)

QTLP600C-R Red

QTLP600C-E Orange

QTLP600C-O Yellow-Orange

QTLP600C-Y Yellow

QTLP600C-AG Yellow-Green

QTLP600C-IG True Green

QTLP600C-IB Blue

ABSOLUTE MAXIMUM RATINGS (T_A =25°C Unless otherwise specified)

Parameter	Symbol	QTLP600C					Units
		-R	-E	-O	-Y	-AG	
Continuous Forward Current	I _F	30	30	30	25	30	mA
Peak Forward Current (f = 1.0 KHz, Duty Factor = 1/10)	I _{FM}	160	160	160	120	160	mA
Reverse Voltage	V _R	5	5	5	5	5	V
Power Dissipation	P _D	72	72	72	60	72	mW
Operating Temperature	T _{OPR}	-40 to +85					°C
Storage Temperature	T _{STG}	-40 to +90					°C
Lead Soldering Time	T _{SOL}	260 for 5 sec					°C

ABSOLUTE MAXIMUM RATINGS (T_A =25°C Unless otherwise specified)

Parameter	Symbol	QTLP600C		Units
		-IB	-IG	
Continuous Forward Current	I _F	30	30	mA
Peak Forward Current (f = 1.0 KHz, Duty Factor = 1/10)	I _{FM}	100	100	mA
Reverse Voltage	V _R	5	5	V
Power Dissipation	P _D	120	120	mW
Operating Temperature	T _{OPR}	-40 to +85		°C
Storage Temperature	T _{STG}	-40 to +90		°C
Lead Soldering Time	T _{SOL}	260 for 5 sec		°C

SURFACE MOUNT LED LAMP

SUPER BRIGHT 0603 (0.8 mm Height)

QTLP600C-R Red

QTLP600C-E Orange

QTLP600C-O Yellow-Orange

QTLP600C-Y Yellow

QTLP600C-AG Yellow-Green

QTLP600C-IG True Green

QTLP600C-IB Blue

ELECTRICAL / OPTICAL CHARACTERISTICS (T_A =25°C)

Part Number	Symbol	QTLP600C					Condition
		-R	-E	-O	-Y	-AG	
Luminous Intensity (mcd)	I _v	15	15	15	15	10	I _F = 20mA
Minimum		35	35	35	35	15	
Typical							
Forward Voltage (V)	V _F	2.4	2.4	2.4	2.4	2.4	I _F = 20mA
Maximum		2.0	2.0	2.0	2.0	2.0	
Typical							
Wavelength (nm)	λ _P	630	620	610	590	575	I _F = 20mA
Peak		624	615	605	589	573	
Dominant	λ _D						
Spectral Line Half Width (nm)	Δλ	20	18	18	15	20	I _F = 20mA
Viewing Angle (°)	2Θ _{1/2}	100	100	100	100	100	I _F = 20mA

ELECTRICAL / OPTICAL CHARACTERISTICS (T_A =25°C)

Part Number	Symbol	QTLP600C		Condition
		-IB	-IG	
Luminous Intensity (mcd)	I _v	15	70	I _F = 20mA
Minimum		25	110	
Typical				
Forward Voltage (V)	V _F	4.0	4.0	I _F = 20mA
Maximum		3.5	3.5	
Typical				
Wavelength (nm)	λ _P	465	520	I _F = 20mA
Peak		470	525	
Dominant	λ _D			
Spectral Line Half Width (nm)	Δλ	25	35	I _F = 20mA
Viewing Angle (°)	2Θ _{1/2}	100	100	I _F = 20mA

QTLP600C-R Red

QTLP600C-E Orange

QTLP600C-O Yellow-Orange

QTLP600C-Y Yellow

QTLP600C-AG Yellow-Green

QTLP600C-IG True Green

QTLP600C-IB Blue

TYPICAL PERFORMANCE CURVES (QTLP600C-R, -E, -O, -Y and -AG)

Fig. 1 Forward Current vs. Forward Voltage

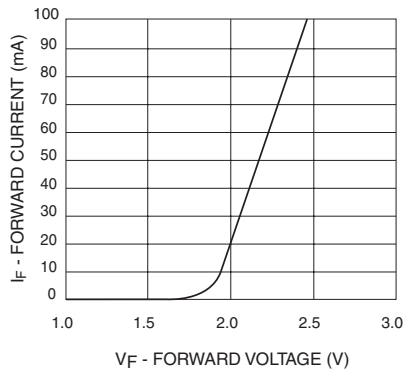

Fig. 2 Relative Luminous Intensity vs. DC Forward Current

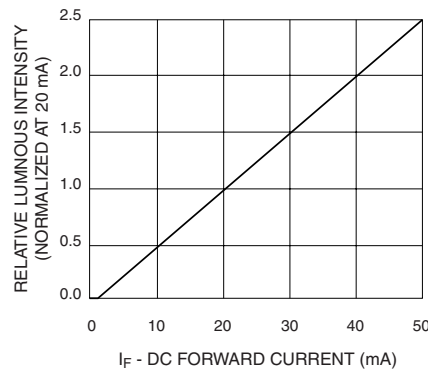

Fig. 3 Relative Intensity vs. Peak Wavelength

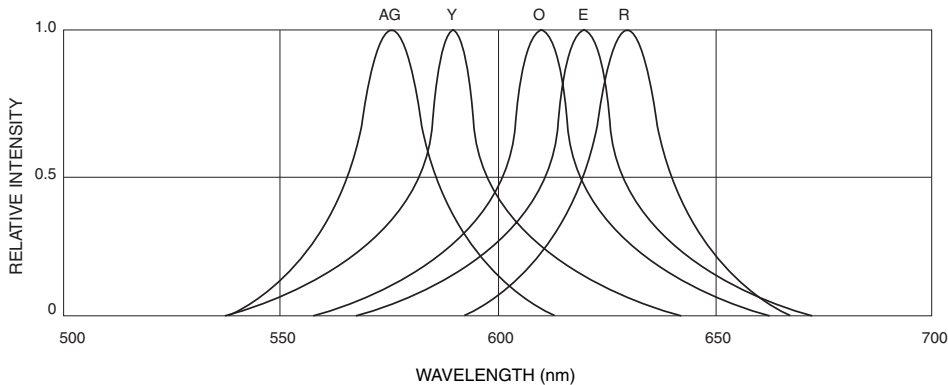

Fig.4 Radiation Diagram

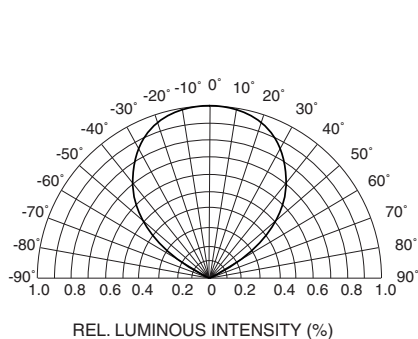
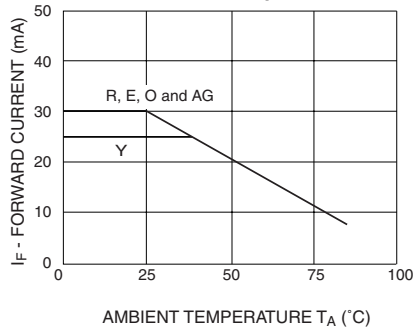

Fig.5 Maximum Forward Current vs. Ambient Temperature



QTLP600C-R Red

QTLP600C-E Orange

QTLP600C-O Yellow-Orange

QTLP600C-Y Yellow

QTLP600C-AG Yellow-Green

QTLP600C-IG True Green

QTLP600C-IB Blue

TYPICAL PERFORMANCE CURVES (QTLP600C-IG and IB)

Fig. 1 Forward Current vs. Forward Voltage

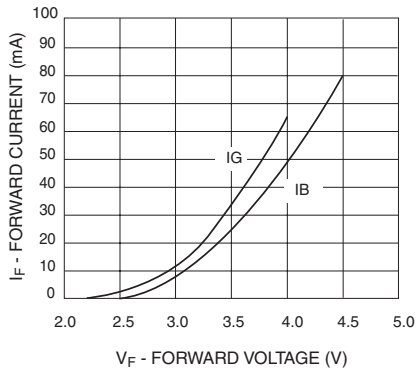

Fig. 2 Relative Luminous Intensity vs. DC Forward Current

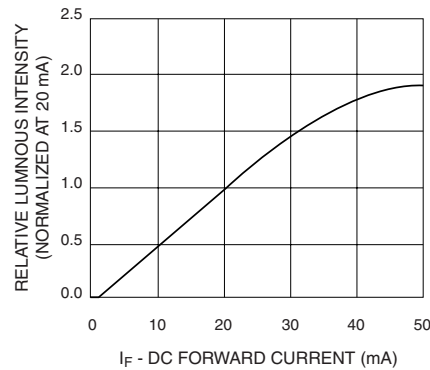

Fig. 3 Relative Intensity vs. Peak Wavelength

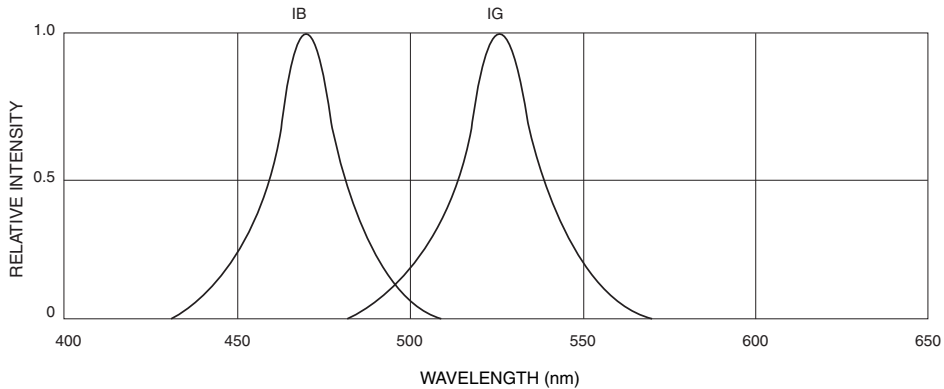

Fig. 4 Radiation Diagram

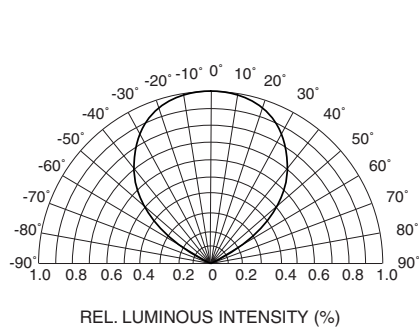
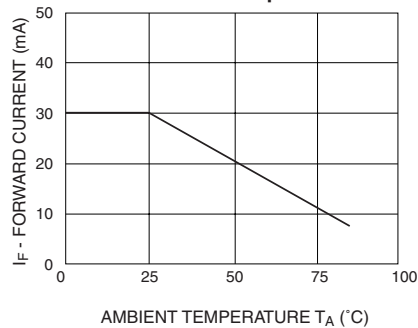

Fig. 5 Maximum Forward Current vs. Ambient Temperature



SURFACE MOUNT LED LAMP SUPER BRIGHT 0603 (0.8 mm Height)

QTLP600C-R Red

QTLP600C-E Orange

QTLP600C-O Yellow-Orange

QTLP600C-Y Yellow

QTLP600C-AG Yellow-Green

QTLP600C-IG True Green

QTLP600C-IB Blue

RECOMMENDED PRINTED CIRCUIT BOARD PATTERN

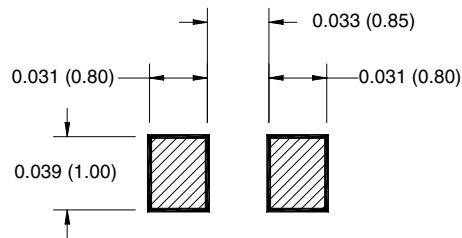

RECOMMENDED IR REFLOW SOLDERING PROFILE

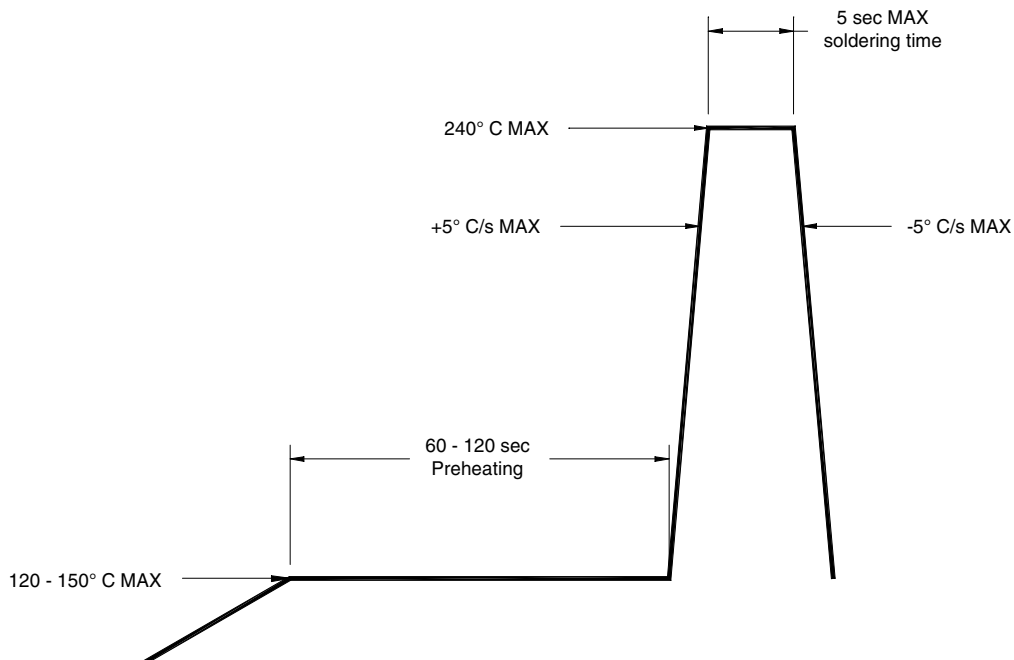

QTLP600C-R Red

QTLP600C-E Orange

QTLP600C-O Yellow-Orange

QTLP600C-Y Yellow

QTLP600C-AG Yellow-Green

QTLP600C-IG True Green

QTLP600C-IB Blue

TAPE AND REEL DIMENSIONS

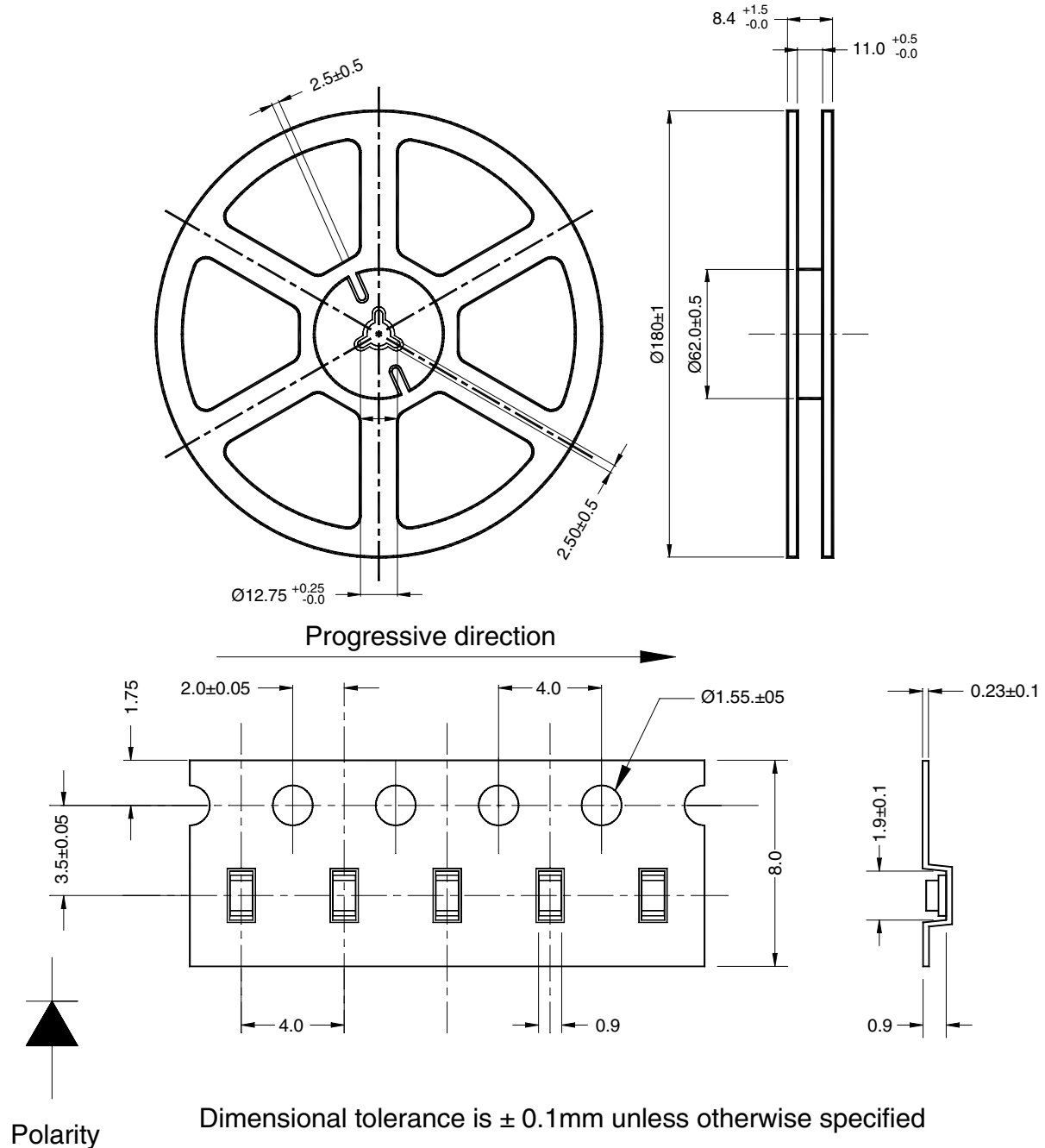

Dimensional tolerance is ± 0.1 mm unless otherwise specified

Angle: ± 0.5

Unit: mm

QTLP600C-R Red

QTLP600C-E Orange

QTLP600C-O Yellow-Orange

QTLP600C-Y Yellow

QTLP600C-AG Yellow-Green

QTLP600C-IG True Green

QTLP600C-IB Blue

DISCLAIMER

FAIRCHILD SEMICONDUCTOR RESERVES THE RIGHT TO MAKE CHANGES WITHOUT FURTHER NOTICE TO ANY PRODUCTS HEREIN TO IMPROVE RELIABILITY, FUNCTION OR DESIGN. FAIRCHILD DOES NOT ASSUME ANY LIABILITY ARISING OUT OF THE APPLICATION OR USE OF ANY PRODUCT OR CIRCUIT DESCRIBED HEREIN; NEITHER DOES IT CONVEY ANY LICENSE UNDER ITS PATENT RIGHTS, NOR THE RIGHTS OF OTHERS.

LIFE SUPPORT POLICY

FAIRCHILD'S PRODUCTS ARE NOT AUTHORIZED FOR USE AS CRITICAL COMPONENTS IN LIFE SUPPORT DEVICES OR SYSTEMS WITHOUT THE EXPRESS WRITTEN APPROVAL OF THE PRESIDENT OF FAIRCHILD SEMICONDUCTOR CORPORATION. As used herein:

1. Life support devices or systems are devices or systems which, (a) are intended for surgical implant into the body, or (b) support or sustain life, and (c) whose failure to perform when properly used in accordance with instructions for use provided in labeling, can be reasonably expected to result in a significant injury of the user.
2. A critical component in any component of a life support device or system whose failure to perform can be reasonably expected to cause the failure of the life support device or system, or to affect its safety or effectiveness.

Fairchild Semiconductor

SEARCH | [Parametric](#) | [Cross Reference](#) | [Inventory](#)
[space](#) [Product Folders and](#) [Applica](#)

[find products](#) [Home >> Find products >>](#)

- [Products groups](#)
- [Analog and Mixed Signal](#)
- [Discrete](#)
- [Interface](#)
- [Logic](#)
- [Microcontrollers](#)
- [Non-Volatile](#)
- [Memory](#)
- [Optoelectronics](#)
- [Markets and applications](#)
- [New products](#)
- [Product selection and parametric search](#)
- [Cross-reference search](#)

- [technical information](#)
- [buy products](#)
- [technical support](#)
- [my Fairchild](#)
- [company](#)

QTLP600C-AG
Yellow-Green Surface Mount LED Lamp - Super Bright 0603 (0.8 mm Height)

Contents
[General description](#) | [Features](#) | [Applications](#) | [Product status/pricing/packaging](#)

General description

These surface mount chip LEDs are designed to fit the industry standard footprint. Small size, low profile and wide viewing angle make these LEDs ideal choices for backlighting applications and panel illumination.

[back to top](#)

Features

- Small footprint - 1.6(L) x 0.8(W) x 0.8(H) mm
- AllnGaP technology for -R, -E, -O, -Y and -AG
- InGaN/SiC technology for -IG and -IB
- Wide viewing angle of 100°
- Water clear optics
- Moisture-proof packaging
- Available in 0.315-inch (8 mm) width tape on 7-inch (178 mm) diameter reel; 2,000 units per reel

[back to top](#)

Applications

- Keypad backlighting
- Push-button backlighting
- LCD backlighting

Datasheet

[Download this datasheet](#)



[e-mail this datasheet](#)



This page

[Print version](#)

Related Links

[Request samples](#)



[How to order products](#)



[Product Change Notices \(PCNs\)](#)



[Support](#)



[Distributor and field sales representatives](#)



[Quality and reliability](#)



[Design tools](#)

[back to top](#)

Product status/pricing/packaging

Product	Product status	Pricing*	Inventory check & ordering	Package type	Packing method
QTLP600CAGTR	Full Production	\$0.071	Purchase	SMD	BOX

* Fairchild 1,000 piece Budgetary Pricing

[back to top](#)

[Home](#) | [Find products](#) | [Technical information](#) | [Buy products](#) | [Support](#) | [Company](#) | [Contact us](#) | [Site index](#) | [Privacy policy](#)

© Copyright 2002 Fairchild Semiconductor

Fairchild Semiconductor

SEARCH | [Parametric](#) | [Cross Reference](#) | [Inventory](#)
[space](#) [Product Folders and](#) [Applica](#)

[find products](#) [Home >> Find products >>](#)

- [Products groups](#)
- [Analog and Mixed Signal](#)
- [Discrete](#)
- [Interface](#)
- [Logic](#)
- [Microcontrollers](#)
- [Non-Volatile](#)
- [Memory](#)
- [Optoelectronics](#)
- [Markets and applications](#)
- [New products](#)
- [Product selection and parametric search](#)
- [Cross-reference search](#)

QTLP600C-E
Red Surface Mount LED Lamp - Super Bright 0603 (0.8 mm Height)

Contents
[General description](#) | [Features](#) | [Applications](#) | [Product status/pricing/packaging](#)

General description

These surface mount chip LEDs are designed to fit the industry standard footprint. Small size, low profile and wide viewing angle make these LEDs ideal choices for backlighting applications and panel illumination.

[back to top](#)

Features

- Small footprint - 1.6(L) x 0.8(W) x 0.8(H) mm
- AllnGaP technology for -R, -E, -O, -Y and -AG
- InGaN/SiC technology for -IG and -IB
- Wide viewing angle of 100°
- Water clear optics
- Moisture-proof packaging
- Available in 0.315-inch (8 mm) width tape on 7-inch (178 mm) diameter reel; 2,000 units per reel

[back to top](#)

Applications

- Keypad backlighting
- Push-button backlighting
- LCD backlighting

Datasheet

[Download this datasheet](#)



[e-mail this datasheet](#)



This page

[Print version](#)

Related Links

[Request samples](#)



[How to order products](#)



[Product Change Notices \(PCNs\)](#)



[Support](#)



[Distributor and field sales representatives](#)



[Quality and reliability](#)



[Design tools](#)

[technical information](#)

[buy products](#)

[technical support](#)

[my Fairchild](#)

[company](#)

[back to top](#)

Product status/pricing/packaging

Product	Product status	Pricing*	Inventory check & ordering	Package type	Packing method
QTLP600CETR	Full Production	\$0.051	Purchase	SMD	BOX

* Fairchild 1,000 piece Budgetary Pricing

[back to top](#)

[Home](#) | [Find products](#) | [Technical information](#) | [Buy products](#) | [Support](#) | [Company](#) | [Contact us](#) | [Site index](#) | [Privacy policy](#)

© Copyright 2002 Fairchild Semiconductor

Fairchild Semiconductor

SEARCH | [Parametric](#) | [Cross Reference](#) | [Inventory](#)

[space](#)

[Product Folders and](#)

[Applica](#)

[find products](#)

[Home](#) >> [Find products](#) >>

[Products groups](#)

[Analog and Mixed](#)

[Signal](#)

[Discrete](#)

[Interface](#)

[Logic](#)

[Microcontrollers](#)

[Non-Volatile](#)

[Memory](#)

[Optoelectronics](#)

[Markets and applications](#)

[New products](#)

[Product selection and parametric search](#)

[Cross-reference search](#)

QTLP600C-IB

Surface Mount LED Lamp - Super Bright 0606

Contents

[General description](#) | [Features](#) | [Applications](#) | [Product status/pricing/packaging](#)

Datasheet

[Download this datasheet](#)

[PDF](#)

[e-mail this datasheet](#)

[\[E-](#)

This page [Print version](#)

[Related Links](#)

[Request samples](#)

[Dotted line](#)

[How to order products](#)

[Dotted line](#)

[Product Change Notices \(PCNs\)](#)

[Dotted line](#)

[Support](#)

[Dotted line](#)

[Distributor and field sales representatives](#)

[Dotted line](#)

[Quality and reliability](#)

[Dotted line](#)

[Design tools](#)

General description

These surface mount chip LEDs are designed to fit the industry standard footprint. Small size, low profile and wide viewing angle make these LEDs ideal choices for backlighting applications and panel illumination.

[back to top](#)

Features

- Small footprint - 1.6(L) x 0.8(W) x 0.8(H) mm
- AllnGaP technology for -R, -E, -O, -Y and -AG
- InGaN/SiC technology for -IG and -IB
- Wide viewing angle of 100°
- Water clear optics
- Moisture-proof packaging
- Available in 0.315-inch (8 mm) width tape on 7-inch (178 mm) diameter reel; 2,000 units per reel

[back to top](#)

Applications

- Keypad backlighting
- Push-button backlighting
- LCD backlighting

[technical information](#)

[buy products](#)

[technical support](#)

[my Fairchild](#)

[company](#)

[back to top](#)

Product status/pricing/packaging

Product	Product status	Pricing*	Inventory check & ordering	Package type	Packing method
QTLP600CIBTR	Full Production	\$0.67	Purchase	SMD	BOX

* Fairchild 1,000 piece Budgetary Pricing

[back to top](#)

[Home](#) | [Find products](#) | [Technical information](#) | [Buy products](#) | [Support](#) | [Company](#) | [Contact us](#) | [Site index](#) | [Privacy policy](#)

[© Copyright 2002 Fairchild Semiconductor](#)

Fairchild Semiconductor

SEARCH | [Parametric](#) | [Cross Reference](#) | [Inventory](#)

[space](#) [Product Folders and](#) [Applica](#)

find products

[Home](#) >> [Find products](#) >>

[Products groups](#)

[Analog and Mixed](#)

[Signal](#)

[Discrete](#)

[Interface](#)

[Logic](#)

[Microcontrollers](#)

[Non-Volatile](#)

[Memory](#)

[Optoelectronics](#)

[Markets and](#)

[applications](#)

[New products](#)

[Product selection and](#)

[parametric search](#)

[Cross-reference](#)

[search](#)

QTLP600C-IG

High Efficiency Red Rectangular Solid State Lamp

Contents

[General description](#) | [Features](#) | [Applications](#) | [Product status/pricing/packaging](#)

General description

These surface mount chip LEDs are designed to fit the industry standard footprint. Small size, low profile and wide viewing angle make these LEDs ideal choices for backlighting applications and panel illumination.

[back to top](#)

Features

- Small footprint - 1.6(L) x 0.8(W) x 0.8(H) mm
- AllnGaP technology for -R, -E, -O, -Y and -AG
- InGaN/SiC technology for -IG and -IB
- Wide viewing angle of 100°
- Water clear optics
- Moisture-proof packaging
- Available in 0.315-inch (8 mm) width tape on 7-inch (178 mm) diameter reel; 2,000 units per reel

[back to top](#)

Applications

- Keypad backlighting
- Push-button backlighting
- LCD backlighting

Related Links

[Request samples](#)

[Dotted line](#)

[How to order products](#)

[Dotted line](#)

[Product Change Notices](#)

[\(PCNs\)](#)

[Dotted line](#)

[Support](#)

[Dotted line](#)

[Distributor and field sales](#)

[representatives](#)

[Dotted line](#)

[Quality and reliability](#)

[Dotted line](#)

[Design tools](#)

Datasheet

[Download this datasheet](#)

PDF

[e-mail this datasheet](#)

[E-]

This page

[Print version](#)

technical information

buy products

technical support

my Fairchild

company

[back to top](#)

Product status/pricing/packaging

Product	Product status	Pricing*	Inventory check & ordering	Package type	Packing method
QTLP600CIGTR	Full Production	\$0.79	Purchase	SMD	BOX

* Fairchild 1,000 piece Budgetary Pricing

[back to top](#)

[Home](#) | [Find products](#) | [Technical information](#) | [Buy products](#) | [Support](#) | [Company](#) | [Contact us](#) | [Site index](#) | [Privacy policy](#)

© Copyright 2002 Fairchild Semiconductor

Fairchild Semiconductor

SEARCH | [Parametric](#) | [Cross Reference](#) | [Inventory](#)

[space](#) [Product Folders and](#) [Applica](#)

find products

[Home](#) >> [Find products](#) >>

[Products groups](#)

[Analog and Mixed](#)

[Signal](#)

[Discrete](#)

[Interface](#)

[Logic](#)

[Microcontrollers](#)

[Non-Volatile](#)

[Memory](#)

[Optoelectronics](#)

[Markets and](#)

[applications](#)

[New products](#)

[Product selection and](#)

[parametric search](#)

[Cross-reference](#)

[search](#)

QTLP600C-O

Yellow Surface Mount LED Lamp - Super Bright 0603 (0.8 mm Height)

Contents

[General description](#) | [Features](#) | [Applications](#) | [Product status/pricing/packaging](#)

Datasheet

[Download this datasheet](#)

PDF

[e-mail this datasheet](#)

[E-]

This page

[Print version](#)

Related Links

[Request samples](#)

[Dotted line](#)

[How to order products](#)

[Dotted line](#)

[Product Change Notices](#)

[\(PCNs\)](#)

[Dotted line](#)

[Support](#)

[Dotted line](#)

[Distributor and field sales](#)

[representatives](#)

[Dotted line](#)

[Quality and reliability](#)

[Dotted line](#)

[Design tools](#)

General description

These surface mount chip LEDs are designed to fit the industry standard footprint. Small size, low profile and wide viewing angle make these LEDs ideal choices for backlighting applications and panel illumination.

[back to top](#)

Features

- Small footprint - 1.6(L) x 0.8(W) x 0.8(H) mm
- AllnGaP technology for -R, -E, -O, -Y and -AG
- InGaN/SiC technology for -IG and -IB
- Wide viewing angle of 100°
- Water clear optics
- Moisture-proof packaging
- Available in 0.315-inch (8 mm) width tape on 7-inch (178 mm) diameter reel; 2,000 units per reel

[back to top](#)

Applications

- Keypad backlighting
- Push-button backlighting
- LCD backlighting

[technical information](#)

[buy products](#)

[technical support](#)

[my Fairchild](#)

[company](#)

[back to top](#)

Product status/pricing/packaging

Product	Product status	Pricing*	Inventory check & ordering	Package type	Packing method
QTLP600COTR	Full Production	\$0.051	Purchase	SMD	BOX

* Fairchild 1,000 piece Budgetary Pricing

[back to top](#)

[Home](#) | [Find products](#) | [Technical information](#) | [Buy products](#) | [Support](#) | [Company](#) | [Contact us](#) | [Site index](#) | [Privacy policy](#)

© Copyright 2002 Fairchild Semiconductor

Fairchild Semiconductor

SEARCH | [Parametric](#) | [Cross Reference](#) | [Inventory](#)

[space](#) [Product Folders and](#) [Applica](#)

find products

[Home](#) >> [Find products](#) >>

[Products groups](#)

[Analog and Mixed](#)

[Signal](#)

[Discrete](#)

[Interface](#)

[Logic](#)

[Microcontrollers](#)

[Non-Volatile](#)

[Memory](#)

[Optoelectronics](#)

[Markets and](#)

[applications](#)

[New products](#)

[Product selection and](#)

[parametric search](#)

[Cross-reference](#)

[search](#)

QTLP600C-R

High Efficiency Red Surface Mount LED Lamp - Standard Bright 0603 (0.6 mm Height)

Contents

[General description](#) | [Features](#) | [Applications](#) | [Product status/pricing/packaging](#)

Datasheet

[Download this datasheet](#)

PDF

[e-mail this datasheet](#)

[E-]

This page

[Print version](#)

Related Links

[Request samples](#)

[Dotted line](#)

[How to order products](#)

[Dotted line](#)

[Product Change Notices \(PCNs\)](#)

[Dotted line](#)

[Support](#)

[Dotted line](#)

[Distributor and field sales representatives](#)

[Dotted line](#)

[Quality and reliability](#)

[Dotted line](#)

[Design tools](#)

General description

These surface mount chip LEDs are designed to fit the industry standard footprint. Small size, low profile and wide viewing angle make these LEDs ideal choices for backlighting applications and panel illumination.

[back to top](#)

Features

- Small footprint - 1.6(L) x 0.8(W) x 0.8(H) mm
- AllnGaP technology for -R, -E, -O, -Y and -AG
- InGaN/SiC technology for -IG and -IB
- Wide viewing angle of 100°
- Water clear optics
- Moisture-proof packaging
- Available in 0.315-inch (8 mm) width tape on 7-inch (178 mm) diameter reel; 2,000 units per reel

[back to top](#)

Applications

- Keypad backlighting
- Push-button backlighting
- LCD backlighting

[technical information](#)

[buy products](#)

[technical support](#)

[my Fairchild](#)

[company](#)

[back to top](#)

Product status/pricing/packaging

Product	Product status	Pricing*	Inventory check & ordering	Package type	Packing method
QTLP600CRTR	Full Production	\$0.051	Purchase	SMD	BOX

* Fairchild 1,000 piece Budgetary Pricing

[back to top](#)

[Home](#) | [Find products](#) | [Technical information](#) | [Buy products](#) | [Support](#) | [Company](#) | [Contact us](#) | [Site index](#) | [Privacy policy](#)

© Copyright 2002 Fairchild Semiconductor

Fairchild Semiconductor

SEARCH | [Parametric](#) | [Cross Reference](#) | [Inventory](#)

[space](#) [Product Folders and](#) [Applica](#)

find products

[Home](#) >> [Find products](#) >>

[Products groups](#)

[Analog and Mixed](#)

[Signal](#)

[Discrete](#)

[Interface](#)

[Logic](#)

[Microcontrollers](#)

[Non-Volatile](#)

[Memory](#)

[Optoelectronics](#)

[Markets and](#)

[applications](#)

[New products](#)

[Product selection and](#)

[parametric search](#)

[Cross-reference](#)

[search](#)

QTLP600C-Y

AlGaAs Red Surface Mount LED Lamp - Standard Bright 0603 (0.6 mm Height)

Contents

[General description](#) | [Features](#) | [Applications](#) | [Product status/pricing/packaging](#)

Datasheet

[Download this datasheet](#)

PDF

[e-mail this datasheet](#)

[E-]

This page

[Print version](#)

Related Links

[Request samples](#)

[Dotted line](#)

[How to order products](#)

[Dotted line](#)

[Product Change Notices \(PCNs\)](#)

[Dotted line](#)

[Support](#)

[Dotted line](#)

[Distributor and field sales representatives](#)

[Dotted line](#)

[Quality and reliability](#)

[Dotted line](#)

[Design tools](#)

General description

These surface mount chip LEDs are designed to fit the industry standard footprint. Small size, low profile and wide viewing angle make these LEDs ideal choices for backlighting applications and panel illumination.

[back to top](#)

Features

- Small footprint - 1.6(L) x 0.8(W) x 0.8(H) mm
- AllnGaP technology for -R, -E, -O, -Y and -AG
- InGaN/SiC technology for -IG and -IB
- Wide viewing angle of 100°
- Water clear optics
- Moisture-proof packaging
- Available in 0.315-inch (8 mm) width tape on 7-inch (178 mm) diameter reel; 2,000 units per reel

[back to top](#)

Applications

- Keypad backlighting
- Push-button backlighting
- LCD backlighting

[technical information](#)

[buy products](#)

[technical support](#)

[my Fairchild](#)

[company](#)

[back to top](#)

Product status/pricing/packaging

Product	Product status	Pricing*	Inventory check & ordering	Package type	Packing method
QTLP600CYTR	Full Production	\$0.051	Purchase	SMD	BOX

* Fairchild 1,000 piece Budgetary Pricing

[back to top](#)

[Home](#) | [Find products](#) | [Technical information](#) | [Buy products](#) | [Support](#) | [Company](#) | [Contact us](#) | [Site index](#) | [Privacy policy](#)

© Copyright 2002 Fairchild Semiconductor

X-ON Electronics

Largest Supplier of Electrical and Electronic Components

Click to view similar products for [Standard LEDs - SMD category](#):

Click to view products by [Everlight manufacturer](#):

Other Similar products are found below :

[LTST-C190KYKT](#) [LTST-C19GD2WT](#) [LTST-N683GBEW](#) [LTW-170ZDC](#) [598-8110-100F](#) [598-8170-100F](#) [598-8610-202F](#) [67-22VRVGC/TR8](#) [AAAF5060QBFSEEZGS](#) [HLMA-QG00-S0021](#) [HLMP-6305-L0011](#) [APT1608QGW](#) [15-21UYC/S530-A3/TR8](#) [EAST2012YA0](#) [EASV1803BA0](#) [LG M67K-H1J2-24-0-2-R18-Z](#) [LS A676-P2S1-1](#) [SML310BATT86](#) [SML-LX0606SISUGC/A](#) [SML-LXL1307SRC-TR](#) [SML-LXR851SIUPGUBC](#) [LT1ED53A](#) [FAT801-S](#) [AM27ZGC03](#) [APB3025SGNC](#) [APFA3010SURKCGKQBDC](#) [APHK1608VGCA](#) [APT2012QGW](#) [LTST-C250KGKT](#) [LTW-010DCG](#) [LTW-020ZDCG](#) [LTW-21TS5](#) [LTW-220DS5](#) [LY L29K-H1J2-26](#) [UYGT801-S](#) [42-21UYC/S530-A3/TR8](#) [LO T67F-V1AB-24-1](#) [YGFR411-H](#) [598-8330-117F](#) [SML-LX0402IC-TR](#) [CMDA20AYAA7D1S](#) [CMDA16AYDR7A1X](#) [598-8040-100F](#) [598-8070-100F](#) [598-8140-100F](#) [598-8610-200F](#) [EAST2012GA0](#) [EAPL3527GA5](#) [EASV3020YGA0](#) [EAST1608RGBAO](#)