

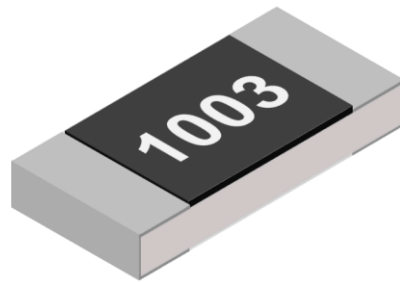

# CLT Series Low TCR Chip Resistor Product Specifications

Document No.	S-10-12-42-04
Released Date	2021/01/27
Page No.	1/10

## ■ Low TCR Chip Resistor — CLT Series



### ■ Application

- Medical, Precision Equipment, Electric meter
- Converters, Communication devices, Battery
- Measuring instrument, Printer, Smart Phone

### ■ Features

- Tight tolerance from  $\pm 0.1\%$ ,  $\pm 0.25\%$ ,  $\pm 0.5\%$ ,  $\pm 1\%$
- Low T.C.R.  $\pm 25\text{ppm}$ ,  $\pm 50\text{ppm}$

## ■ Parts Number Explanation

Example:

CLT	0603	F	220K	P	05	4
Product Type	Size (Inch)	Resistor Tolerance	Resistor Value	Package	Quantity	Optional
CLT	0402 0603 0805 1206 1210 2010 2512	B : $\pm 0.1\%$ C : $\pm 0.25\%$ D : $\pm 0.5\%$ F : $\pm 1\%$	1K=1K00 100K=100K 1M=1M00	P : Paper Taping (0603~1210) Q : Paper Taping (0402) E : Embossed Taping	04 : 4000PCS 05 : 5000PCS 10 : 10000PCS 40 : 40000PCS 50 : 50000PCS	4 : TCR $\pm 25\text{ppm}$ 5 : TCR $\pm 50\text{ppm}$



## CLT Series Low TCR Chip Resistor Product Specifications

Document No.	S-10-12-42-04
Released Date	2021/01/27
Page No.	2/10

### ■ Standard Electrical Specifications

Item Type	Rated Power at 70°C	Max Working Voltage	Max Overload Voltage	T.C.R. (PPM/°C)	Resistance Range	
					B(±0.1%)、C(±0.25%)	D(±0.5%)、F(±1%)
CLT0402	0.063W	25V	50V	±25	100KΩ ~ 332KΩ	
				±50	100Ω ≤ R ≤ 1MΩ	
CLT0603	0.1W	75V	150V	±25	100KΩ ≤ R ≤ 1MΩ	100KΩ ≤ R ≤ 3M32Ω
				±50	100Ω ≤ R ≤ 1MΩ	100Ω ≤ R ≤ 3M32Ω
CLT0805	0.125W	150V	300V	±25	100KΩ ≤ R ≤ 1MΩ	100KΩ ≤ R ≤ 3M32Ω
				±50	100Ω ≤ R ≤ 1MΩ	100Ω ≤ R ≤ 3M32Ω
CLT1206	0.25W	200V	400V	±25	100KΩ ≤ R ≤ 1MΩ	100KΩ ≤ R ≤ 3M32Ω
CLT1210	0.5W			±50	100Ω ≤ R ≤ 1MΩ	100Ω ≤ R ≤ 3M32Ω
				±25	100KΩ ≤ R ≤ 1MΩ	100KΩ ≤ R ≤ 3M32Ω
CLT2010	0.75W			±50	100Ω ≤ R ≤ 1MΩ	100Ω ≤ R ≤ 3M32Ω
				±25	100KΩ ≤ R ≤ 1MΩ	100KΩ ≤ R ≤ 3M32Ω
CLT2512	1W			±50	100Ω ≤ R ≤ 1MΩ	100Ω ≤ R ≤ 3M32Ω
				±25	100KΩ ≤ R ≤ 1MΩ	100KΩ ≤ R ≤ 3M32Ω

- For non-standard parts, please contact our sales dept.
- Operating Temperature Range : -55°C ~ +155°C.

## ■ Type Dimension

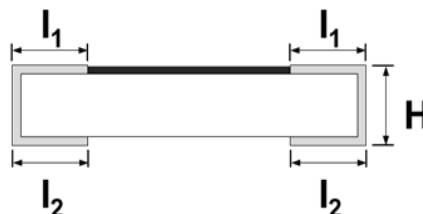
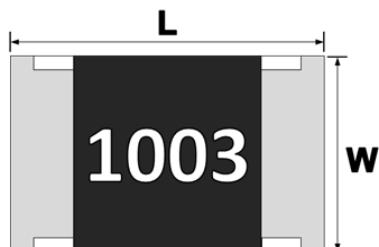

TYPE	L	W	H	l <sub>1</sub>	l <sub>2</sub>
CLT0402	1.00 ± 0.10	0.50 ± 0.05	0.30 ± 0.05	0.15 ± 0.10	0.20 ± 0.10
CLT0603	1.60 ± 0.20	0.80 ± 0.15	0.40 ± 0.10	0.30 ± 0.20	0.30 ± 0.10
CLT0805	2.00 ± 0.20	1.25 ± 0.15	0.50 ± 0.15	0.30 ± 0.15	0.40 ± 0.15
CLT1206	3.05 ± 0.10	1.60 ± 0.20	0.55 ± 0.15	0.40 ± 0.20	0.50 ± 0.20
CLT1210	3.05 ± 0.10	2.50 ± 0.20	0.55 ± 0.15	0.50 ± 0.20	0.50 ± 0.20
CLT2010	5.00 ± 0.20	2.50 ± 0.20	0.55 ± 0.10	0.60 ± 0.20	0.60 ± 0.20
CLT2512	6.30 ± 0.20	3.20 ± 0.20	0.55 ± 0.10	0.60 ± 0.20	0.60 ± 0.20

## ● General Information

### ■ Recommend Land Pattern Design

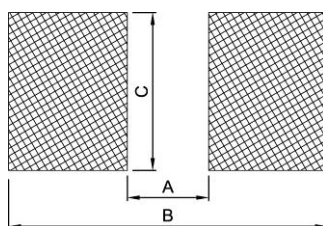

### ■ Dimension

Unit: mm

Item \ Type	0402	0603	0805	1206	1210	2010	2512
A	0.60	0.80	1.30	2.20	2.00	3.80	4.90
B	1.60	2.40	2.90	4.20	4.40	6.60	8.10
C	0.70	1.00	1.40	1.70	2.70	2.70	3.40



# CLT Series Low TCR Chip Resistor Product Specifications

Document No.	S-10-12-42-04
Released Date	2021/01/27
Page No.	4/10

## ■ Performance Characteristics

### ■ Power Derating Curve

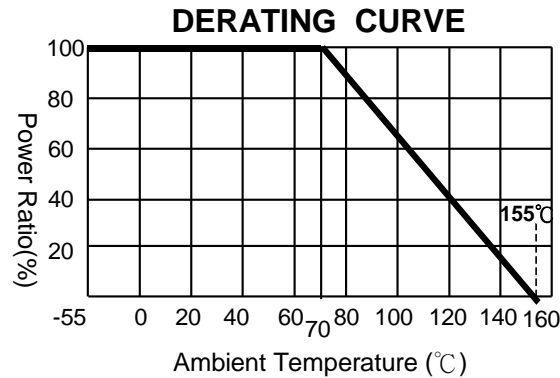

Power rating or current rating is in the case based on continuous full-load at ambient temperature of 70°C. For operation at ambient temperature in excess of 70°C, the load should be derated in accordance with figure of derating Curve.

### ■ Voltage Rating or Current Rating

Resistance Range:  $\geq 1 \Omega$

Rated Voltage: The resistor shall have a DC continuous working voltage or a RMS AC continuous working voltage at commercial-line frequency and wave form corresponding to the power rating, as determined formula as following:

$$E(RCWV) = \sqrt{P \times R}$$

E=Rated voltage(V)  
P=Power rating(W)  
R=Nominal resistance( $\Omega$ )



# CLT Series Low TCR Chip Resistor Product Specifications

Document No.	S-10-12-42-04
Released Date	2021/01/27
Page No.	5/10

## Reliability Test and Requirement

Test Item	Test Method	Procedure	Requirements
Temperature Coefficient of Resistance (T.C.R)	JIS-C-5201-1 4.8 IEC-60115-1 4.8	At 25 / -55°C and 25°C /+155°C, 25°C is the reference temperature	Refer to Ratings
Short Time Overload	JIS-C-5201-1 4.13 IEC-60115-1 4.13	2.5 times RCWV or Max. Overload voltage whichever is less for 5 seconds.	±(1.0%+0.05Ω)
Leaching	JIS-C-5201-1 4.18 IEC-60068-2-58 8.2.1	260±5°C for 30 seconds.	Individual leaching area ≤ 5% Total leaching area ≤ 10%
Resistance to Soldering Heat	JIS-C-5201-1 4.18 IEC-60115-1 4.18	260±5°C for 10 seconds.	±(0.5%+0.05Ω)
Rapid Change of Temperature	JIS-C-5201-1 4.19 IEC-60115-1 4.19	-55°C to +155°C, 5 cycles	±(0.5%+0.05Ω)
Resistance to Solvent	JIS-C-5201-1 4.29	The tested resistor be immersed into isopropyl alcohol of 20~25°C for 60 secs. Then the resistor is left in the room for 48 hrs.	±(0.5%+0.05Ω)
Damp Heat with Load	JIS-C-5201-1 4.24 IEC-60115-1 4.24	40±2°C, 90~95% R.H. RCWV or Max. working voltage whichever is less for 1000 hrs with 1.5 hrs "ON" and 0.5 hrs "OFF" .	±(1.0%+0.05Ω)
Load Life (Endurance)	JIS-C-5201-1 4.25 IEC-60115-1 4.25.1	70±2°C, RCWV or Max. working voltage whichever is less for 1000 hrs with 1.5 hrs "ON" and 0.5 hr "OFF" .	±(1.0%+0.05Ω)
Insulation Resistance	JIS-C-5201-1 4.6 IEC-60115-1 4.6	Apply 100VDC for 1 minute.	≥ 10GΩ
Bending Strength	JIS-C-5201-1 4.33 IEC-60115-1 4.33	Bending once for 5 seconds D : 0402、0603、0805=5mm 1206、1210、1812=3mm 1218、2010、2512、2030=2mm	±(1.0%+0.05Ω)

## Recommended Customer Soldering Parameters

### Wave solder Temperature condition

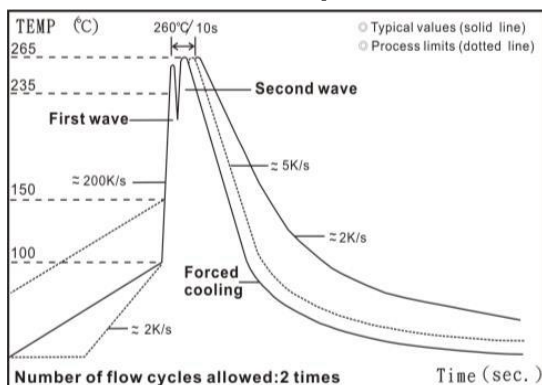

## ■ Solder reflow Temperature condition

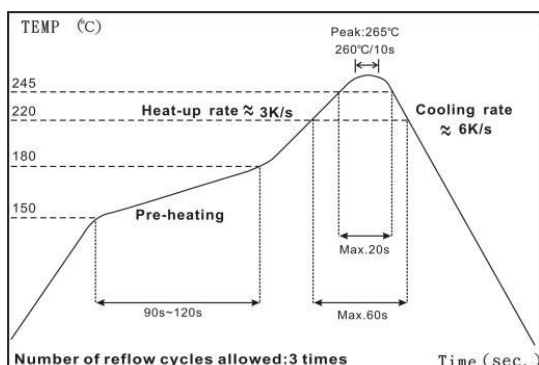

■ Rework temperature (hot air equipment) : 350°C, 3~5seconds

### ■ Recommended reflow methods

IR, vapor phase oven, hot air oven

If reflow temperatures exceed the recommended profile, devices may not meet the performance requirements.

## ■ Appendix For SMD Chip Resistor

### ● Packaging Information

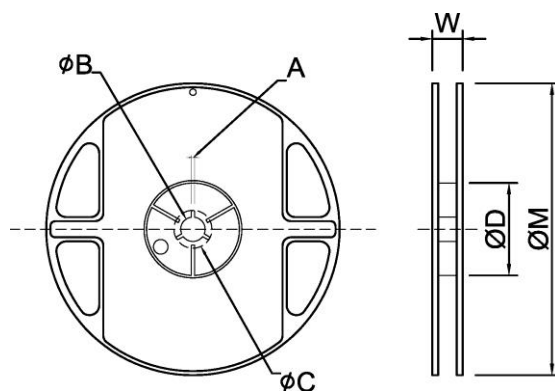

### ■ Dimension

Unit: mm

TYPE	SIZE	A	ΦB	ΦC	ΦD	W	ΦM
0402	7"	10K/Reel	2.0±0.5	13.5±1.0	21±1.0	60±1.0	178±2.0
	13"	40K/50K Reel	2.0±0.5	13.5±1.0	21±1.0	100±1.0	330±2.0
0603/0805/1206/ 1210	7"	5K/Reel	2.0±0.5	13.5±1.0	21±1.0	60±1.0	178±2.0
0603/0805 /1206	10"	10K/Reel	2.0±0.5	13.5±1.0	21±1.0	100±1.0	254±2.0
	13"	20K/Reel	2.0±0.5	13.5±1.0	21±1.0	100±1.0	330±2.0
2010/2512	7"	4K/Reel	2.0±0.5	13.5±1.0	21±1.0	16.0±2.0	178±2.0



# CLT Series Low TCR Chip Resistor Product Specifications

Document No. S-10-12-42-04

Released Date 2021/01/27

Page No. 7/10

## ■ Tapping Specification

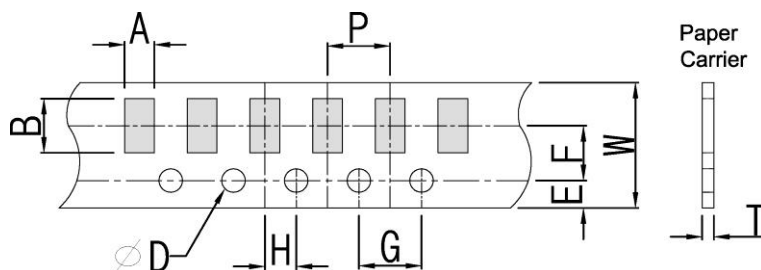

Unit: mm

## ■ Dimension

Packaging	Type	A	B	W	E	F	G	H	T	ΦD	P
Paper Type	0402	0.70±0.1	1.20±0.1	8.0±0.2	1.75±0.1	3.5±0.05	4.0±0.1	2.0±0.05	0.45±0.1	1.50 <sup>+0.10</sup> <sub>-0</sub>	2.0±0.1
	0603	1.05±0.2	1.80±0.2	8.0±0.2	1.75±0.1	3.5±0.05	4.0±0.1	2.0±0.05	0.60±0.1		4.0±0.1
	0805	1.55±0.2	2.30±0.2	8.0±0.2	1.75±0.1	3.5±0.05	4.0±0.1	2.0±0.05	0.75±0.1		
	1206	1.90±0.2	3.50±0.2	8.0±0.2	1.75±0.1	3.5±0.05	4.0±0.1	2.0±0.05	0.75±0.1		
	1210	2.85±0.2	3.50±0.2	8.0±0.2	1.75±0.1	3.5±0.05	4.0±0.1	2.0±0.05	0.75±0.1		

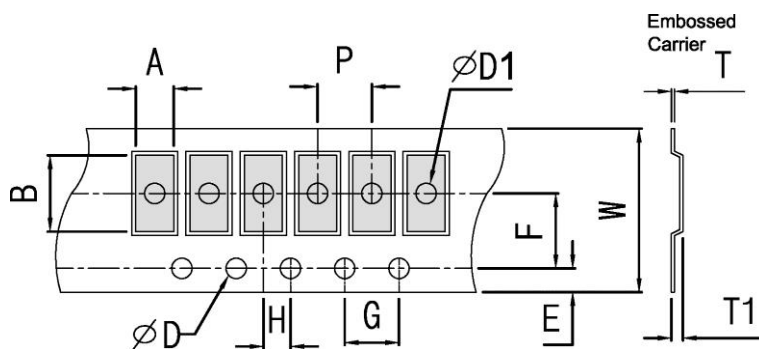

Unit: mm

## ■ Dimension

Packaging	Type	A	B	W	E	F	G	H	T	ΦD	ΦD1	T1	P
Embossed Type	2010	2.80±0.20	5.60±0.20	12±0.10	1.75±0.10	5.5±0.05	4.0±0.10	2.0±0.05	0.23±0.10	1.50 <sup>+0.10</sup> <sub>-0</sub>	1.50±0.10	0.85±0.15	4.0±0.1
	2512	3.40±0.20	6.70±0.20	12±0.10	1.75±0.10	5.5±0.05	4.0±0.10	2.0±0.05	0.23±0.10		1.50±0.10	0.85±0.15	



# CLT Series Low TCR Chip Resistor Product Specifications

Document No.	S-10-12-42-04
Released Date	2021/01/27
Page No.	8/10

## ■ Packing Material Data/Storage Data

### ■ Front & Back Lead Dimension

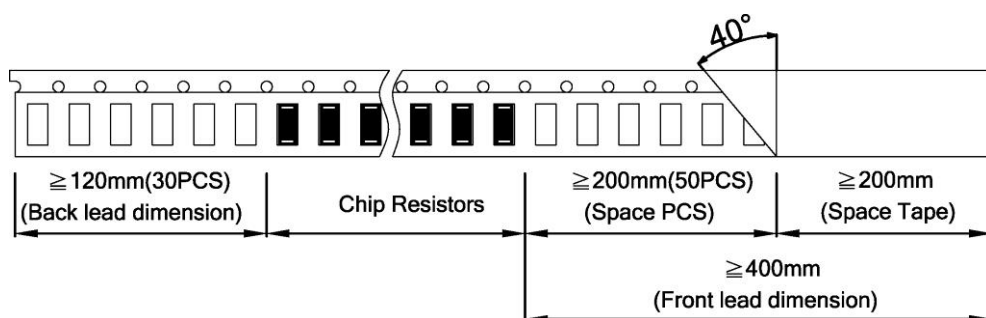

### ■ Top Adhesive Peel Off Strength : 10~70g

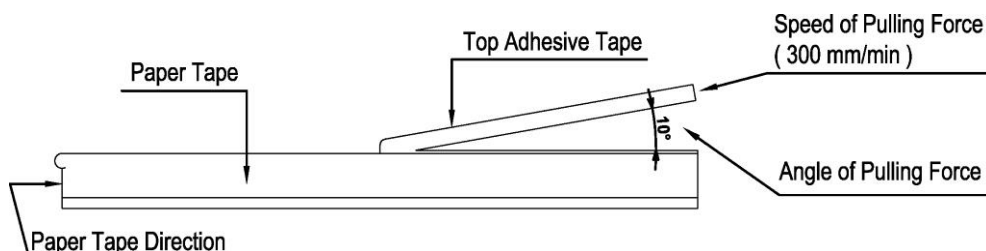

### ■ Package

Inner Box Size	
Reel	Size H(mm)
1	13
2	24
3	36
5	60
10	113

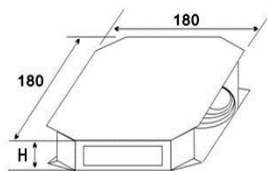

External Box Size			
Contain (Kpcs)	Length (mm)	Width (mm)	Height (mm)
25K	180	180	60
50K	180	180	110
150K	430	200	200
300K	400	400	200

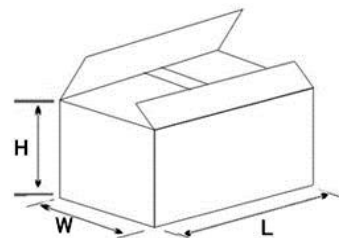

### ■ Storage Data :

Storage time at the environment temp:  $25\pm 5^\circ\text{C}$  & humidity:  $60\pm 20\%$  is valid for one year from the date of delivery.







## CLT Series Low TCR Chip Resistor Product Specifications

Document No.	S-10-12-42-04
Released Date	2021/01/27
Page No.	10/10

### ■ Standard Resistance Values in a Decade

Marking code:

- 1%: marking code, please refer to E96 and E24 data form as below  
     Ex: 120K, The marking code is 1203 in E24  
     121K, The marking code is 1213 in E96
- 5%: marking code, please refer to E24 data form as below  
     Ex: 120K, The marking code is 124 in E24
- Note: 0402 series resistor has no marking code.
- Type: 0603 1% marking code, please refer to E-96 multiplier code.

E192	E96	E48	E192	E96	E48	E192	E96	E48	E192	E96	E48	E192	E96	E48	
100	100	100	169	169	169	287	287	287	487	487	487	825	825	825	
101			172			291			493			835			
102	102		174	174		294	294		499	499		845	845		
104			176			298			505			856			
105	105	105	178	178	178	301	301	301	511	511	511	866	866	866	
106			180			305			517			876			
107	107		182	182		309	309		523	523		887	887		
109			184			312			530			898			
110	110	110	187	187	187	316	316	316	536	536	536	909	909	909	
111			189			320			542			920			
113	113		191	191		324	324		549	549		931	931		
114			193			328			556			942			
115	115	115	196	196	196	332	332	332	562	562	562	953	953	953	
117			198			336			569			965			
118	118		200	200		340	340		576	576		976	976		
120			203			344			583			988			
121	121	121	205	205	205	348	348	348	590	590	590				
123			208			352			597						
124	124		210	210		357	357		604	604		E24	E12	E6	E3
126			213			361			612			10	10	10	10
127	127	127	215	215	215	365	365	365	619	619	619	11			
129			218			370			626			12	12		
130	130		221	221		374	374		634	634		13			
132			223			379			642			15	15	15	
133	133	133	226	226	226	383	383	383	649	649	649	16			
135			229			388			657			18	18		
137	137		232	232		392	392		665	665		20			
138			234			397			673			22	22	22	22
140	140	140	237	237	237	402	402	402	681	681	681	24			
142			240			407			690			27	27		
143	143		243	243		412	412		698	698		30			
145			246			417			706			33	33	33	
147	147	147	249	249	249	422	422	422	715	715	715	36			
149			252			427			723			39	39		
150	150		255	255		432	432		732	732		43			
152			258			437			741			47	47	47	47
154	154	154	261	261	261	442	442	442	750	750	750	51			
156			264			448			759			56	56		
158	158		267	267		453	453		768	768		62			
160			271			459			777			68	68	68	
162	162	162	274	274	274	464	464	464	787	787	787	75			
164			277			470			796			82	82		
165	165		280	280		475	475		806	806		91			
167			284			481			816						

**According to IEC publication 63**

## X-ON Electronics

Largest Supplier of Electrical and Electronic Components

*Click to view similar products for [Thick Film Resistors - SMD category](#):*

*Click to view products by [Ever Ohms manufacturer](#):*

Other Similar products are found below :

[CR-05FL7--150R](#) [CR-05FL7--698K](#) [CR-12FP4--324R](#) [CR-12JP4--680R](#) [M55342K06B10D0RS6](#) [M55342K06B14E0RS6](#)  
[M55342K06B1E78RS3](#) [M55342K06B24E9RS6](#) [M55342K06B6E19RWL](#) [M55342K06B6E81RS3](#) [M55342M05B200DRWB](#)  
[M55342M06B4K70MS3](#) [MC0603-511-JTW](#) [742C083750JTR](#) [MCR01MZPF1202](#) [MCR01MZPF1601](#) [MCR01MZPF1800](#)  
[MCR01MZPF6201](#) [MCR01MZPF9102](#) [MCR01MZPJ113](#) [MCR01MZPJ121](#) [MCR01MZPJ125](#) [MCR01MZPJ751](#) [MCR03EZHZ103](#)  
[MCR03EZPF2004](#) [MCR03EZPJ270](#) [MCR03EZPJ821](#) [MCR10EZPF1102](#) [MCR10EZPF2700](#) [MCR18EZPJ330](#) [RC1005F1152CS](#)  
[RC1005F1182CS](#) [RC1005F1372CS](#) [RC1005F183CS](#) [RC1005F1911CS](#) [RC1005F1912CS](#) [RC1005F203CS](#) [RC1005F2052CS](#)  
[RC1005F241CS](#) [RC1005F2431CS](#) [RC1005F3011CS](#) [RC1005F303CS](#) [RC1005F4321CS](#) [RC1005F4642CS](#) [RC1005F471CS](#)  
[RC1005F4751CS](#) [RC1005F5621CS](#) [RC1005F6041CS](#) [RC1005J106CS](#) [RC1005J121CS](#)