

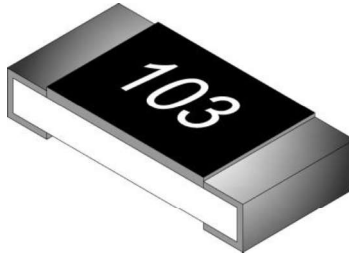

CR-Series Thick Film Chip Resistor Product Specifications

Document No.	S-10-12-01-10
Revision Date	2020/05/04
Page No.	1/12

■ Thick Film Chip Resistor — CR Series



■ Application

- Entertainment: Stereo, TV tuners, Tape recorder
- Appliance: Air conditioner, Refrigerator
- Computer & relative products: Main board, PDA
- Communication equipment: Cell phone, Fax machine
- Power equipment: Power supply, Illumination equipment
- Measuring instrument: Electric meter, Navigation equipment

■ Features

- Small size and light weight
- Reduction of assembly costs and matching with placement machines
- Reliability, high quality and fast delivery

■ Parts Number Explanation

Example:

CR	0603	J	10R0	P	05	Z
Product Type	Size (Inch)	Resistor Tolerance	Resistor Value	Package	Quantity	Optional
CR: Thick Film	0201 0402 0603 0805 1206 1210 1812 2010 2512	B : ±0.1% D : ±0.5% F : ±1% G : ±2% J : ±5%	10mR=R010 100mR=R100 1R=1R00 10R=10R0 100R=100R 1K=1K00 1M=1M00	P : Paper Taping (0603~1210) Q : Paper Taping (0201、0402) E : Embossed Taping	01 : 1000PCS 02 : 2000PCS 04 : 4000PCS 05 : 5000PCS 10 : 10000PCS 20 : 20000PCS 40 : 40000PCS 50 : 50000PCS	Z : Default code (Resistor Paste). S : TCR ±100ppm. R : Metal Paste.



CR-Series Thick Film Chip Resistor Product Specifications

Document No.	S-10-12-01-10
Revision Date	2020/05/04
Page No.	2/12

■ Standard Electrical Specifications

Type	Item	Rated Power at 70℃	Max Working Voltage	Max Overload Voltage	T.C.R. (PPM/℃)	Resistance Range		
						B(±0.1%)	F(±1%)	G(±2%) J(±5%)
CR0201		0.05 W	25V	50V	-200/+400	-	1Ω ≤ R < 10Ω	
					±200	-	10Ω ≤ R ≤ 10MΩ	
Type	Item	Rated Power at 70℃	Max Working Voltage	Max Overload Voltage	T.C.R. (PPM/℃)	Resistance Range		
						B(±0.1%)	D(±0.5%) F(±1%)	G(±2%) J(±5%)
CR0402		0.063 W	50V	100V	±400	-	1Ω ≤ R < 10Ω	
					±100	10Ω ≤ R ≤ 1MΩ	10Ω ≤ R ≤ 10MΩ	
CR0603		0.1 W	75V	150V	±400	-	1Ω ≤ R < 10Ω	
					±100	10Ω ≤ R ≤ 1MΩ	10Ω ≤ R ≤ 10MΩ	
CR0805		0.125 W	150V	300V	±400	-	1Ω ≤ R < 10Ω	
					±100	10Ω ≤ R ≤ 1MΩ	10Ω ≤ R ≤ 10MΩ	
CR1206		0.25 W	200V	400V	±400	-	1Ω ≤ R < 10Ω	
					±100	10Ω ≤ R ≤ 1MΩ	10Ω ≤ R ≤ 10MΩ	
CR1210		0.5 W	200V	400V	±400	-	1Ω ≤ R < 10Ω	
					±100	10Ω ≤ R ≤ 1MΩ	10Ω ≤ R ≤ 10MΩ	
CR1812		0.75 W	200V	400V	±400	-	1Ω ≤ R < 10Ω	
					±100	10Ω ≤ R ≤ 1MΩ	10Ω ≤ R ≤ 10MΩ	
CR2010		0.75 W	200V	400V	±400	-	1Ω ≤ R < 10Ω	
					±100	10Ω ≤ R ≤ 1MΩ	10Ω ≤ R ≤ 10MΩ	
CR2512		1 W	200V	400V	±400	-	1Ω ≤ R < 10Ω	
					±100	10Ω ≤ R ≤ 1MΩ	10Ω ≤ R ≤ 10MΩ	

- For non-standard parts, please contact our sales dept.
- Operating Temperature Range : -55℃ ~ +155℃
- Type CR0603/0805/1206/1210/1812/2010/2512 1Ω ≤ R ≤ 10Ω optional code 「S」 is Low TCR Alloy Film: ±100 PPM/℃

Type	0201	0402	0603	0805	1206	1210	1812	2010	2512
Jumper Resistance Value	50mΩ Max								
Jumper Rated Current	0.5A	1A			2A				
Max. Over Load Current <1 second and 1 times	1A	3A			10A				



CR-Series Thick Film Chip Resistor Product Specifications

Document No.	S-10-12-01-10
Revision Date	2020/05/04
Page No.	3/12

● Low Ohm Chip Resistor

■ Standard Electrical Specifications

Item Type	Rated Power at 70℃	Rated Voltage Range	Max Overload Voltage	T.C.R. (PPM/℃)	Resistance Range (mΩ)
					F(±1%)、J(±5%)
CR0402	0.063 W	0.12~0.25V	0.624 V	±1000	220 ≤ R ≤ 450
				±800	450 < R < 1000
CR0603	0.1 W	0.09~0.31V	0.775 V	±1000	75 ≤ R < 100
				±800	100 ≤ R ≤ 330
				±600	330 < R < 1000
CR0805	0.125 W	0.04~0.35V	0.875 V	±1800	10 ≤ R < 50
				±800	50 ≤ R < 100
				±600	100 ≤ R < 1000
CR1206	0.25 W	0.05~0.5V	1.25 V	±1800	10 ≤ R < 50
				±800	50 ≤ R < 100
				±600	100 ≤ R < 1000
CR1210	0.5 W	0.07~0.7V	1.75 V	±1800	10 ≤ R < 50
				±800	50 ≤ R < 100
				±600	100 ≤ R < 1000
CR1812	0.75 W	0.08~0.8V	2.15 V	±1800	10 ≤ R < 50
				±800	50 ≤ R < 100
				±600	100 ≤ R < 1000
CR2010	0.75 W	0.08~0.8V	2.15 V	±1800	10 ≤ R < 50
				±800	50 ≤ R < 100
				±600	100 ≤ R < 1000
CR2512	1 W	0.1~0.99V	2.475V	±1800	10 ≤ R < 50
				±800	50 ≤ R < 100
				±600	100 ≤ R < 1000

● For non-standard parts, please contact our sales dept.

● Operating Temperature Range : -55℃ ~ +155℃.

● Type CR1206/1210/1812/2010/2512 100 mΩ ≤ R < 1000 mΩ optional code 「R」 is Metal Paste.
TCR ±200 PPM/℃ (100 mΩ ≤ R ≤ 200 mΩ), TCR ±100 PPM/℃ (200 mΩ < R < 1000 mΩ)

● Type CR1206 10 mΩ ≤ R < 100 mΩ optional code 「R」 is Metal Paste.
TCR ±1800 PPM/℃ (10 mΩ ≤ R < 20 mΩ), TCR ±1200 PPM/℃ (20 mΩ ≤ R < 50 mΩ), TCR ±300 PPM/℃ (50 mΩ ≤ R < 100 mΩ)

● Type CR2512 10 mΩ ≤ R < 100 mΩ optional code 「R」 is Metal Paste.
TCR ±1800 PPM/℃ (10 mΩ ≤ R < 20 mΩ), TCR ±800 PPM/℃ (20 mΩ ≤ R < 50 mΩ), TCR ±200 PPM/℃ (50 mΩ ≤ R < 100 mΩ)



CR-Series Thick Film Chip Resistor Product Specifications

Document No.	S-10-12-01-10
Revision Date	2020/05/04
Page No.	4/12

● High Ohm Chip Resistor

■ Standard Electrical Specifications

Type	Item	Rated Power at 70 °C	Max Working Voltage	Max Overload Voltage	T.C.R. (PPM/°C)	Resistance Range	
						F(±1%)	J(±5%)
CR0402		0.063 W	50V	100V	±200	10.1 MΩ ~ 30 MΩ	10.1 MΩ ~ 30 MΩ
CR0603		0.1 W	75V	150V			
CR0805		0.125 W	150V	300V			
CR1206		0.25 W	200V	400V			
CR1210		0.5 W					
CR2010		0.75 W					
CR2512		1 W					

- For non-standard parts, please contact our sales dept.
- Operating Temperature Range : -55°C ~ +155°C.

■ Type Dimension

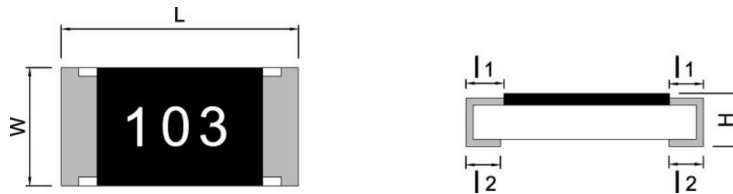

CR0201 / CR0402 / CR0603 / CR0805 / CR1206
CR1210 / CR1812 / CR2010 / CR2512

TYPE	L	W	H	l ₁	l ₂
CR0201	0.60 ± 0.03	0.30 ± 0.03	0.23 ± 0.05	0.15 ± 0.05	0.15 ± 0.05
CR0402	1.00 ± 0.10	0.50 ± 0.05	0.30 ± 0.05	0.15 ± 0.10	0.20 ± 0.10
CR0603	1.60 ± 0.20	0.80 ± 0.15	0.40 ± 0.10	0.30 ± 0.20	0.30 ± 0.10
CR0805	2.00 ± 0.20	1.25 ± 0.15	0.50 ± 0.15	0.30 ± 0.15	0.40 ± 0.15
CR1206	3.05 ± 0.10	1.60 ± 0.20	0.55 ± 0.15	0.40 ± 0.20	0.50 ± 0.20
CR1210	3.05 ± 0.10	2.50 ± 0.20	0.55 ± 0.15	0.50 ± 0.20	0.50 ± 0.20
CR1812	4.50 ± 0.10	3.10 ± 0.20	0.55 ± 0.05	0.55 ± 0.20	0.70 ± 0.20
CR2010	5.00 ± 0.20	2.50 ± 0.20	0.55 ± 0.10	0.60 ± 0.20	0.60 ± 0.20
CR1218	3.10 ± 0.10	4.60 ± 0.10	0.55 ± 0.05	0.40 ± 0.20	0.50 ± 0.20
CR2512	6.30 ± 0.20	3.20 ± 0.20	0.55 ± 0.10	0.60 ± 0.20	0.60 ± 0.20



CR-Series Thick Film Chip Resistor Product Specifications

Document No.	S-10-12-01-10
Revision Date	2020/05/04
Page No.	5/12

● General Information

■ Recommend Land Pattern Design

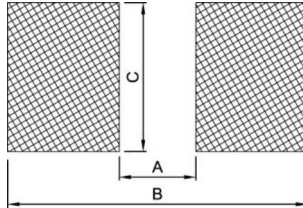

■ Dimension

Unit:mm

Item \ Type	0201	0402	0603	0805	1206	1210	1812	2010	2512
A	0.25	0.60	0.80	1.30	2.20	2.00	3.11	3.80	4.90
B	1.10	1.60	2.40	2.90	4.20	4.40	5.91	6.60	8.10
C	0.32	0.70	1.00	1.40	1.70	2.70	3.00	2.70	3.40

■ Performance Characteristics

■ Power Derating Curve

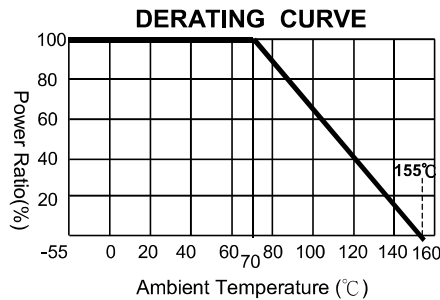

Power rating or current rating is in the case based on continuous full-load at ambient temperature of 70°C. For operation at ambient temperature in excess of 70°C, the load should be derated in accordance with figure of derating Curve.

■ Voltage Rating or Current Rating

Resistance Range: $\geq 1\Omega$

Rated Voltage: The resistor shall have a DC continuous working voltage or a RMS AC continuous working voltage at commercial-line frequency and wave form corresponding to the power rating, as determined formula as following:

$$E(RCWV)=\sqrt{P \times R}$$

E=Rated voltage(V)
P=Power rating(W)
R=Nominal resistance(Ω)



CR-Series Thick Film Chip Resistor Product Specifications

Document No.	S-10-12-01-10
Revision Date	2020/05/04
Page No.	6/12

● Reliability Test and Requirement

Test Item	Test Method	Procedure	Requirements
Temperature Coefficient of Resistance (T.C.R)	JIS-C-5201-1 4.8 IEC-60115-1 4.8	At 25 / -55°C and 25°C / +155°C, 25°C is the reference temperature	As Spec
Short Time Overload	JIS-C-5201-1 4.13 IEC-60115-1 4.13	2.5 times RCWV or Max. Overload voltage whichever is less for 5 seconds. Jumper : Over Load Current for 5 seconds 0201=1A , 0402/0603/0805=2.5A 1206/1210/1812/2010/2512=5A	1% and below : $\pm(1.0\%+0.05\Omega)$ 2% · 5% : $\pm(2.0\%+0.10\Omega)$ Jumper : Max 0.05Ω after test.
Leaching	JIS-C-5201-1 4.18 IEC-60068-2-58 8.2.1	260±5°C for 30 seconds.	Individual leaching area ≤ 5% Total leaching area ≤ 10%
Resistance to Soldering Heat	JIS-C-5201-1 4.18 IEC-60115-1 4.18	260±5°C for 10 seconds.	1% and below : $\pm(0.5\%+0.05\Omega)$ 2% · 5% : $\pm(1.0\%+0.05\Omega)$
Rapid Change of Temperature	JIS-C-5201-1 4.19 IEC-60115-1 4.19	-55°C to +155°C, 5 cycles	1% and below : $\pm(0.5\%+0.05\Omega)$ 2% · 5% : $\pm(1.0\%+0.10\Omega)$
Resistance to Solvent	JIS-C-5201-1 4.29	The tested resistor be immersed into isopropyl alcohol of 20~25°C for 60 secs. Then the resistor is left in the room for 48 hrs.	1% and below : $\pm(0.5\%+0.05\Omega)$ 2% · 5% : $\pm(0.5\%+0.05\Omega)$ Jumper : Max 0.05Ω after test.
Damp Heat with Load	JIS-C-5201-1 4.24 IEC-60115-1 4.24	40±2°C, 90~95% R.H. RCWV or Max. working voltage whichever is less for 1000 hrs with 1.5 hrs "ON" and 0.5 hrs "OFF" .	1% and below : $\pm(1.0\%+0.05\Omega)$ 2% · 5% : $\pm(2.0\%+0.05\Omega)$ Value <1Ω : $\pm(2.0\%+0.05\Omega)$ Jumper : Max 0.1Ω after test.
Load Life (Endurance)	JIS-C-5201-1 4.25 IEC-60115-1 4.25.1	70±2°C, RCWV or Max. working voltage whichever is less for 1000 hrs with 1.5 hrs "ON" and 0.5 hrs "OFF" .	1% and below : $\pm(1.0\%+0.05\Omega)$ 2% · 5% : $\pm(3.0\%+0.10\Omega)$ Value <1Ω : $\pm(3.0\%+0.10\Omega)$ Jumper : Max 0.1Ω after test.
Insulation Resistance	JIS-C-5201-1 4.6 IEC-60115-1 4.6	Apply 100VDC for 1 minute.	≥ 10GΩ
Bending Strength	JIS-C-5201-1 4.33 IEC-60115-1 4.33	Bending once for 5 seconds D : 0402 · 0603 · 0805=5mm 1206 · 1210 · 1812=3mm 2010 · 2512=2mm	1% and below : $\pm(1.0\%+0.05\Omega)$ 2% · 5% : $\pm(1.0\%+0.05\Omega)$



CR-Series Thick Film Chip Resistor Product Specifications

Document No.	S-10-12-01-10
Revision Date	2020/05/04
Page No.	7/12

■ Recommended Customer Soldering Parameters

■ Wave solder Temperature condition

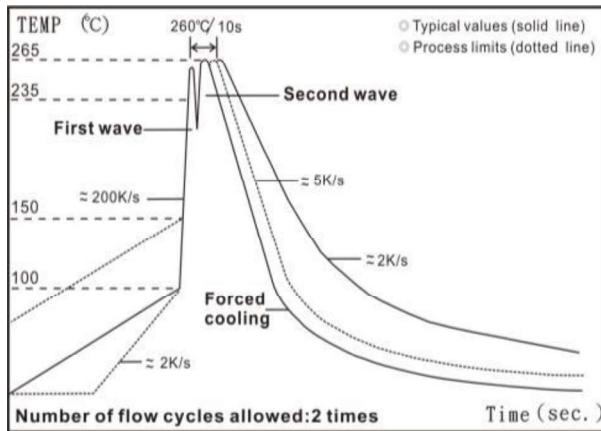

■ Solder reflow Temperature condition

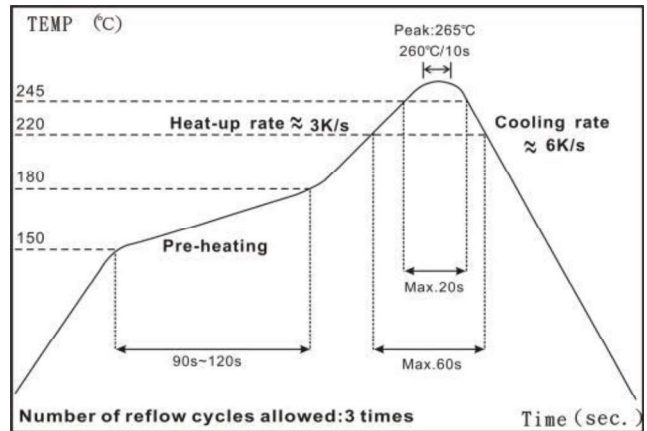

■ Solder reflow Temperature condition

■ Rework temperature (hot air equipment) : 350°C, 3~5seconds

■ Recommended reflow methods

IR, vapor phase oven, hot air oven

If reflow temperatures exceed the recommended profile, devices may not meet the performance requirements.



CR-Series Thick Film Chip Resistor Product Specifications

Document No.	S-10-12-01-10
Revision Date	2020/05/04
Page No.	8/12

■ Appendix For SMD Chip Resistor

● Packaging Information

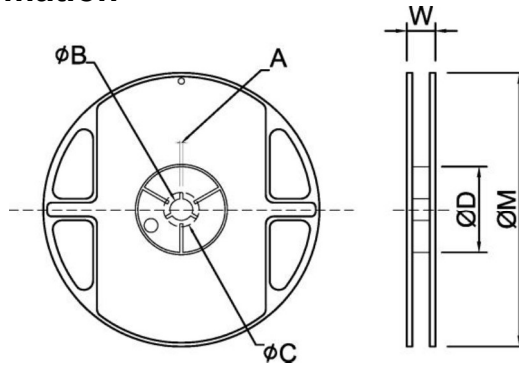

■ Dimension

Unit:mm

TYPE	SIZE	A	ϕB	ϕC	ϕD	W	ϕM
0201/0402	7" 10K/Reel (0201 & 0402) 15K/Reel (0201 only)	2.0±0.5	13.5±1.0	21±1.0	60±1.0	11.5±2.0	178±2.0
0402	13" 40K/50K Reel	2.0±0.5	13.5±1.0	21±1.0	100±1.0	11.5±2.0	330±2.0
0603/0805/1206/1210	7" 5K/Reel	2.0±0.5	13.5±1.0	21±1.0	60±1.0	11.5±2.0	178±2.0
0603/0805/1206	10" 10K/Reel	2.0±0.5	13.5±1.0	21±1.0	100±1.0	11.5±2.0	254±2.0
	13" 20K/Reel	2.0±0.5	13.5±1.0	21±1.0	100±1.0	11.5±2.0	330±2.0
2010/2512/1812	7" 4K/Reel	2.0±0.5	13.5±1.0	21±1.0	60±1.0	16.0±2.0	178±2.0



CR-Series Thick Film Chip Resistor Product Specifications

Document No.	S-10-12-01-10
Revision Date	2020/05/04
Page No.	9/12

■ Tapping Specification

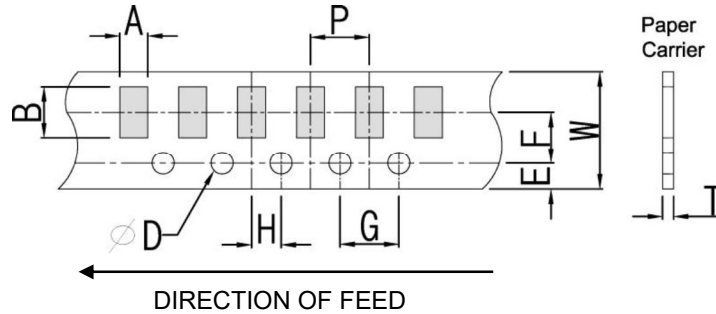

■ Dimension

Unit:mm

Packaging	Type	A	B	W	E	F	G	H	T	ϕD	P
Paper Type	0201	0.45±0.1	0.75±0.1	8.0±0.2	1.75±0.1	3.5±0.05	4.0±0.1	2.0±0.05	0.35±0.1	1.50 +0.10 -0	2.0±0.1
	0402	0.70±0.1	1.20±0.1	8.0±0.2	1.75±0.1	3.5±0.05	4.0±0.1	2.0±0.05	0.45±0.1		
	0603	1.05±0.2	1.80±0.2	8.0±0.2	1.75±0.1	3.5±0.05	4.0±0.1	2.0±0.05	0.60±0.1		4.0±0.1
	0805	1.55±0.2	2.30±0.2	8.0±0.2	1.75±0.1	3.5±0.05	4.0±0.1	2.0±0.05	0.75±0.1		
	1206	1.90±0.2	3.50±0.2	8.0±0.2	1.75±0.1	3.5±0.05	4.0±0.1	2.0±0.05	0.75±0.1		
	1210	2.85±0.2	3.50±0.2	8.0±0.2	1.75±0.1	3.5±0.05	4.0±0.1	2.0±0.05	0.75±0.1		

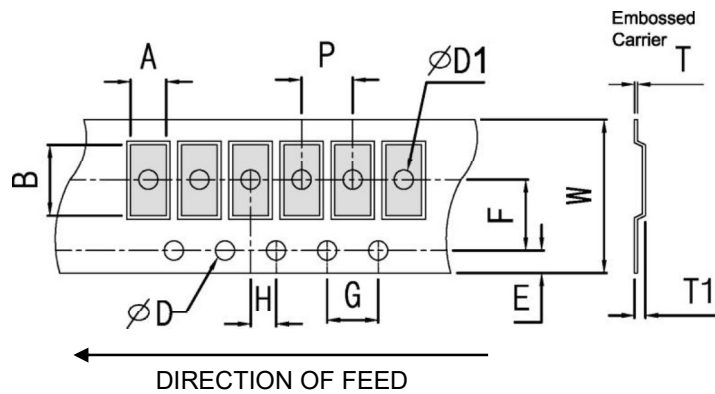

■ Dimension

Unit: mm

Packaging	Type	A	B	W	E	F	G	H	T	ϕD	$\psi D1$	T1	P
Embossed Type	2010	2.80±0.20	5.60±0.20	12±0.10	1.75±0.10	5.5±0.05	4.0±0.10	2.0±0.05	0.23±0.10	1.50 +0.10 -0	1.50±0.10	0.85±0.15	4.0±0.1
	2512	3.40±0.20	6.70±0.20	12±0.10	1.75±0.10	5.5±0.05	4.0±0.10	2.0±0.05	0.23±0.10		1.50±0.10	0.85±0.15	
	1812	3.30±0.20	4.60±0.20	12±0.10	1.75±0.10	5.5±0.05	4.0±0.10	2.0±0.05	0.23±0.10		1.50±0.10	0.85±0.15	



CR-Series Thick Film Chip Resistor Product Specifications

Document No.	S-10-12-01-10
Revision Date	2020/05/04
Page No.	10/12

■ Packing Material Data/Storage Data

■ Front & Back Lead Dimension

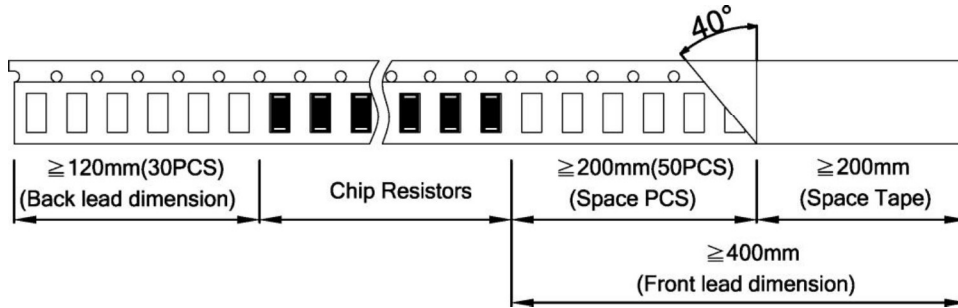

■ Top Adhesive Peel Off Strength : 10~70g

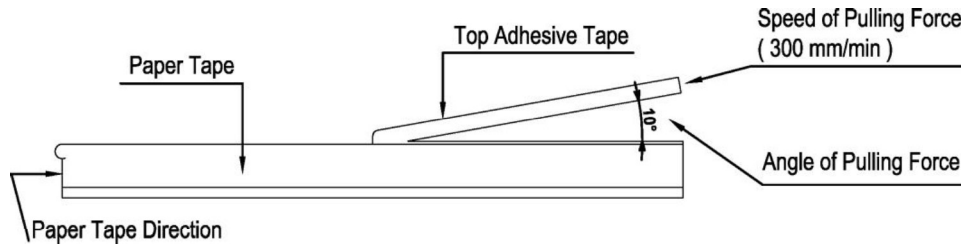

■ Package

Inner Box Size	
Reel	Size H(mm)
1	13
2	24
3	36
5	60
10	113

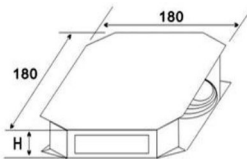

External Box Size			
Contain (Kpcs)	Length (mm)	Width (mm)	Height (mm)
25K	180	180	60
50K	180	180	110
150K	430	200	200
300K	400	400	200

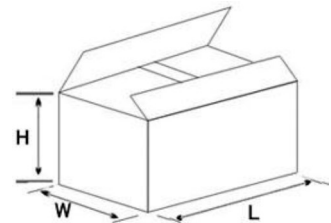

■ Storage Data :

Storage time at the environment temp: $25 \pm 5^\circ\text{C}$ & humidity: $60 \pm 20\%$ is valid for one year from the date of delivery.

■ Product Testing Method:

Our products are tested with our company's tapping & testing equipments by using four-foot probe to touch at the back of both electrodes. Supposed different testing points or methods are requested, please advise beforehand and customized-made production is available.



CR-Series Thick Film Chip Resistor Product Specifications

Document No.	S-10-12-01-10
Revision Date	2020/05/04
Page No.	11/12

■ Marking

■ General Resistance Codes



0402: no marking



0603: 3 digits code



0805~2512: 3 digits code(5%)

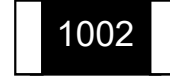

0805~2512: 4 digits code
(1% and below)

■ No marking on 0402 and 0201 type

■ 3 digits code for 0603 type

● Standard E96 Values and 0603 Resistance Codes

R-Value	100	102	105	107	110	113	115	118	121	124	127	130	133	137	140	143	147	150	154	158	162	165	169	174
Code	01	02	03	04	05	06	07	08	09	10	11	12	13	14	15	16	17	18	19	20	21	22	23	24
R-Value	178	182	187	191	196	200	205	210	215	221	226	232	237	243	249	255	261	267	274	280	287	294	301	309
Code	25	26	27	28	29	30	31	32	33	34	35	36	37	38	39	40	41	42	43	44	45	46	47	48
R-Value	316	324	332	340	348	357	365	374	383	392	402	412	422	432	442	453	464	475	487	499	511	523	536	549
Code	49	50	51	52	53	54	55	56	57	58	59	60	61	62	63	64	65	66	67	68	69	70	71	72
R-Value	562	576	590	604	619	634	649	665	681	698	715	732	750	768	787	806	825	845	866	887	909	931	953	976
Code	73	74	75	76	77	78	79	80	81	82	83	84	85	86	87	88	89	90	91	92	93	94	95	96

● E96 Multiplier Code

Code	A	B	C	D	E	F	G	H	X	Y	Z
Multiplier	10 ⁰	10 ¹	10 ²	10 ³	10 ⁴	10 ⁵	10 ⁶	10 ⁷	10 ⁻¹	10 ⁻²	10 ⁻³

1. 0603 3 digits coding formula for E96 values as following:

CODING FORMULA

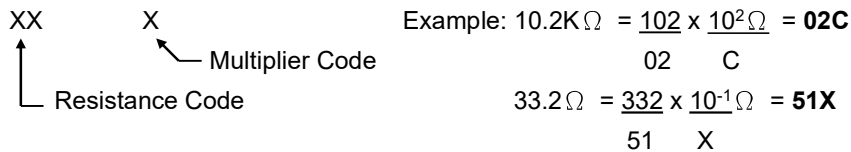

EX.: 7.5Ω=85Y ; 11Ω=05X ; 130Ω=12A ; 2KΩ= 30B ; 10KΩ=01C ; 150KΩ=18D

E24	10	11	12	13	15	16	18	20	22	24	27	30	33	36	39	43	47	51	56	62	68	75	82	91
-----	----	----	----	----	----	----	----	----	----	----	----	----	----	----	----	----	----	----	----	----	----	----	----	----

■ 0603 ~2512 3 digits for E24 values (±5%)

Examples:

Resistance	4.7Ω	33Ω	470Ω	5.6KΩ	62KΩ	680KΩ
3 digits code	4R7	330	471	562	623	684

("R"= decimal point)

■ 4 digits code for 0805 ~ 2512 type

First 3 digits are the significant figures, the 4th digit is the multiplier. "R"= decimal point.

Examples:

Resistance	5.6Ω	10Ω	22.6Ω	100Ω	1.1KΩ	10KΩ	332KΩ	1MΩ
4 digits code	5R60	10R0	22R6	1000	1101	1002	3323	1004



CR-Series Thick Film Chip Resistor Product Specifications

Document No.	S-10-12-01-10
Revision Date	2020/05/04
Page No.	12/12

■ mΩ Resistance Codes



0402: no marking



0603: 3 digits



0805~2512: 4 digits

■ 0402 : No marking

■ 0603 : 3 digit marking

1. For E-24 values:

Resistance value	Code	Example
10mΩ ~ 99mΩ	0XX	068 = 68mΩ
100mΩ ~ 990mΩ	RXX	R68 = 680mΩ

E-24	10	11	12	13	15	16	18	20	22	24	27	30	33	36	39	43	47	51	56	62	68	75	82	91
------	----	----	----	----	----	----	----	----	----	----	----	----	----	----	----	----	----	----	----	----	----	----	----	----

2. For E-96 values: excluding values 10/11/13/15/20/75 of E-24 series.

● Standard E-96 Values and 0603 Resistance Codes

R-Value	100	102	105	107	110	113	115	118	121	124	127	130	133	137	140	143	147	150	154	158	162	165	169	174
Code	01	02	03	04	05	06	07	08	09	10	11	12	13	14	15	16	17	18	19	20	21	22	23	24
R-Value	178	182	187	191	196	200	205	210	215	221	226	232	237	243	249	255	261	267	274	280	287	294	301	309
Code	25	26	27	28	29	30	31	32	33	34	35	36	37	38	39	40	41	42	43	44	45	46	47	48
R-Value	316	324	332	340	348	357	365	374	383	392	402	412	422	432	442	453	464	475	487	499	511	523	536	549
Code	49	50	51	52	53	54	55	56	57	58	59	60	61	62	63	64	65	66	67	68	69	70	71	72
R-Value	562	576	590	604	619	634	649	665	681	698	715	732	750	768	787	806	825	845	866	887	909	931	953	976
Code	73	74	75	76	77	78	79	80	81	82	83	84	85	86	87	88	89	90	91	92	93	94	95	96

● E-96 Multiplier Code

Code	A	B	C	D	E	F	G	H	X	Y	Z
Multiplier	10 ⁰	10 ¹	10 ²	10 ³	10 ⁴	10 ⁵	10 ⁶	10 ⁷	10 ⁻¹	10 ⁻²	10 ⁻³

● 0603 3 digits coding formula for E-96 values as following:

CODING FORMULA

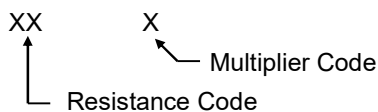

Example: $499 \text{ m}\Omega = 499 \times 10^{-3} \Omega = \mathbf{68Z}$

68 Z

■ 0805~2512 : 4 digit marking

1. For E-24 values:

Resistance value	Code	Example
10mΩ ~ 990mΩ	RXXX	R680 = 680mΩ

■ Note: jumper zero ohm resistor marking code is one 「0」 (except type below 0402).

X-ON Electronics

Largest Supplier of Electrical and Electronic Components

Click to view similar products for [Thick Film Resistors - SMD category](#):

Click to view products by [Ever Ohms manufacturer](#):

Other Similar products are found below :

[CR-05FL7--150R](#) [CR-05FL7--19K6](#) [CR-05FL7--243R](#) [CR-05FL7--40K2](#) [CR-05FL7--698K](#) [CR-12FP4--324R](#) [CR-12JP4--680R](#)
[M55342K06B1E78RS3](#) [M55342K06B6E19RWL](#) [M55342K06B6E81RS3](#) [M55342M05B200DRWB](#) [M55342M06B4K70MS3](#) [MC0603-511-](#)
[JTW](#) [742C083750JTR](#) [MCR01MZPF1202](#) [MCR01MZPF1601](#) [MCR01MZPF1800](#) [MCR01MZPF6201](#) [MCR01MZPF9102](#) [MCR01MZPJ113](#)
[MCR01MZPJ121](#) [MCR01MZPJ125](#) [MCR01MZPJ751](#) [MCR03EZHJ103](#) [MCR03EZPFX2004](#) [MCR03EZPJ270](#) [MCR03EZPJ821](#)
[MCR10EZPF1102](#) [MCR18EZPJ330](#) [RC0603F1473CS](#) [RC0603F150CS](#) [RC1005F1152CS](#) [RC1005F1182CS](#) [RC1005F1372CS](#)
[RC1005F183CS](#) [RC1005F1911CS](#) [RC1005F1912CS](#) [RC1005F203CS](#) [RC1005F2052CS](#) [RC1005F241CS](#) [RC1005F2431CS](#)
[RC1005F3011CS](#) [RC1005F303CS](#) [RC1005F4321CS](#) [RC1005F4642CS](#) [RC1005F471CS](#) [RC1005F4751CS](#) [RC1005F5621CS](#)
[RC1005F6041CS](#) [RC1005J106CS](#)