

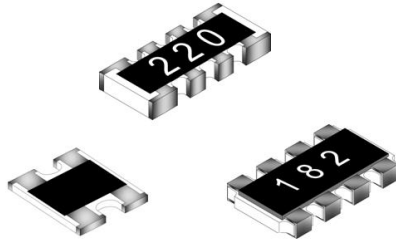

CRA-Series Thick Film Array Chip Resistor Product Specifications

Document No.	S-10-12-02-03
Released Date	2019/01/03
Page No.	1/8

■ Thick Film Array Chip Resistor — CRA Series



■ Application

- Entertainment: Stereo, TV tuners, Tape recorder
- Appliance: Air conditioner, Refrigerator
- Computer & relative products: Main board, PDA
- Communication equipment: Cell phone, Fax machine
- Power equipment: Power supply, Illumination equipment
- Measuring instrument: Electric meter, Navigation equipment

■ Features

- Small size and light weight
- Reduction of assembly costs and matching with placement machines
- Reliability, high quality and fast delivery

■ Type Dimension

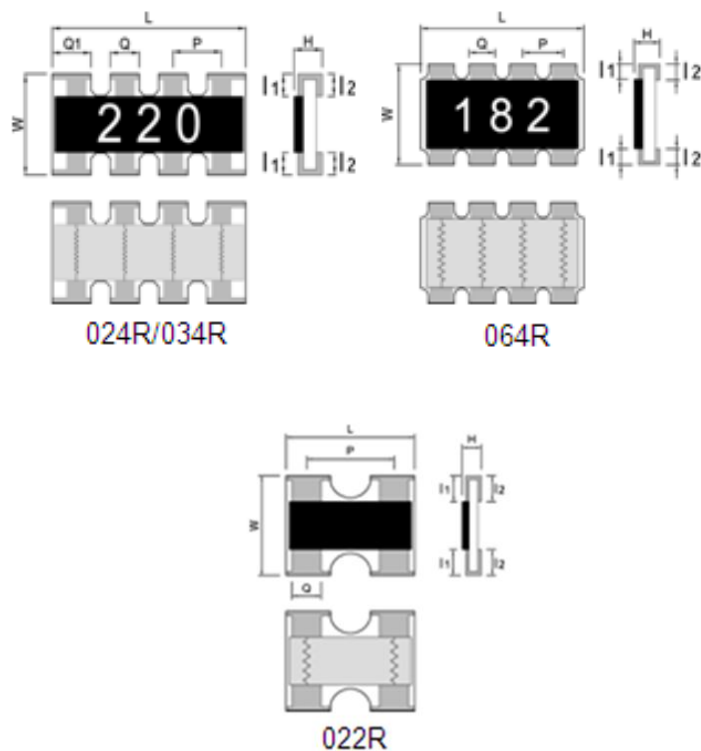

■ Dimension

Unit: mm

TYPE	L	W	H	I ₁	I ₂	P	Q	Q1
CRA022R	1.00±0.10	1.00±0.10	0.33±0.05	0.15±0.10	0.25±0.10	0.67±0.10	0.34±0.10	---
CRA024R	2.00±0.10	1.00±0.10	0.40±0.10	0.20±0.10	0.20±0.10	0.50±0.10	0.30±0.10	0.43±0.10
CRA034R	3.20±0.20	1.60±0.15	0.50±0.10	0.30±0.20	0.30±0.20	0.80±0.20	0.50±0.15	0.61±0.10
CRA064R	5.10±0.20	3.10±0.20	0.55±0.15	0.55±0.15	0.55±0.15	1.30±0.20	0.90±0.10	---



CRA-Series Thick Film Array Chip Resistor Product Specifications

Document No.	S-10-12-02-03
Released Date	2019/01/03
Page No.	3/8

Standard Electrical Specifications

Item Type	Rating Power at 70°C	Max Working Voltage	Max Overload Voltage	T.C.R. (PPM/°C)	Resistance Range	Operating Temperature
					F(±1%) J±(5%)	
CRA022R	0.063 W	25V	50V	±400	1Ω~9.9Ω	-55°C ~ +155°C
				±200	10Ω~1MΩ	
CRA024R	0.063 W	25V	50V	±400	1Ω~9.9Ω	
				±200	10Ω~1MΩ	
CRA034R	0.1 W	50V	100V	±400	1Ω~9.9Ω	
				±200	10Ω~1MΩ	
CRA064R	0.25 W	200V	400V	±400	1Ω~9.9Ω	
				±200	10Ω~1MΩ	

- For non-standard parts, please contact our sales dept.
- Operating Temperature Range : -55°C ~ +155°C.

Type	022R	024R	034R	064R
Jumper Rated Current	1A			2A

Parts Number Explanation

Example:

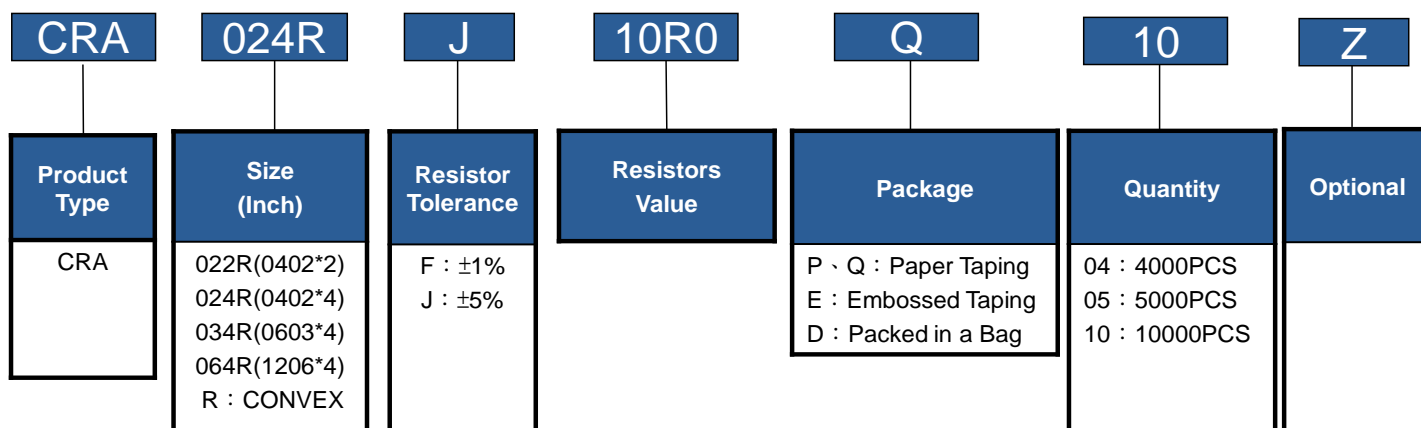

Appendix For SMD Chip Resistor

● Packaging Information

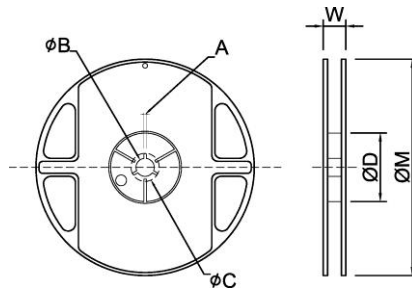

Dimension

Unit: mm

TYPE	SIZE		A	φB	φC	φD	W	φM
022R/024R	7"	10K/Reel	2.0±0.5	13.5±1.0	21±1.0	60±1.0	11.5±2.0	178±2.0
034R	7"	5K/Reel	2.0±0.5	13.5±1.0	21±1.0	60±1.0	11.5±2.0	178±2.0
064R	7"	4K/Reel	2.0±0.5	13.5±1.0	21±1.0	60±1.0	16.0±2.0	178±2.0

■ Tapping Specification

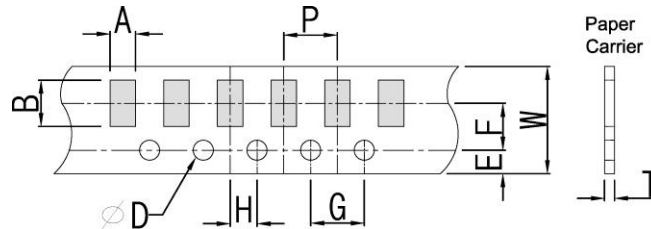

Dimension

Unit: mm

Packaging	Type	A	B	W	E	F	G	H	T	φD	P
Paper Type	022R	1.25±0.1	1.25±0.1	8.0±0.2	1.75±0.1	3.5±0.05	4.0±0.1	2.0±0.05	0.45±0.1	1.50	2.0±0.1
	024R	1.20±0.1	2.20±0.1	8.0±0.2	1.75±0.1	3.5±0.05	4.0±0.1	2.0±0.05	0.60±0.1		
	034R	1.90±0.2	3.50±0.2	8.0±0.2	1.75±0.1	3.5±0.05	4.0±0.1	2.0±0.05	0.75±0.1	-0	4.0±0.1

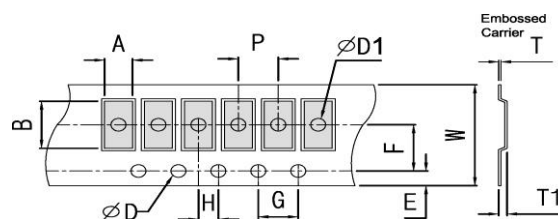

Dimension

Unit: mm

Packaging	Type	A	B	W	E	F	G	H	T	φD	ψD1	T1	P
Embossed Type	064R	3.55±0.2	5.55±0.2	12±0.3	1.75±0.1	5.5±0.05	4.0±0.1	2.0±0.05	0.25±0.1	+0.10	+0.25	0.85±0.15	4.0±0.1
										-0	-0		



CRA-Series Thick Film Array Chip Resistor Product Specifications

Document No.	S-10-12-02-03
Released Date	2019/01/03
Page No.	5/8

■ Packing Material Data/Storage Data

■ Front & Back Lead Dimension

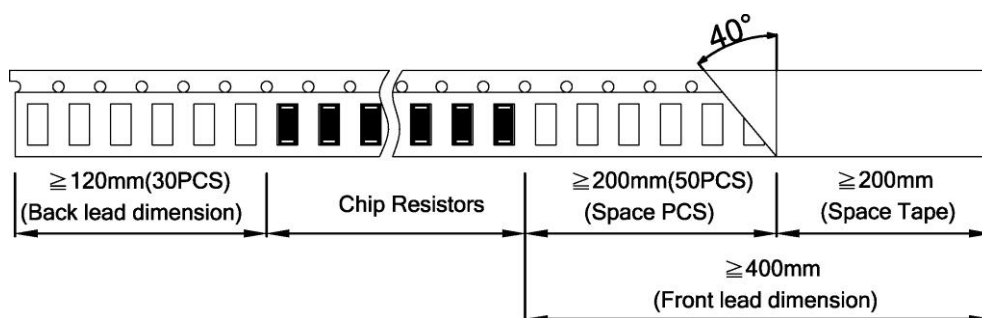

■ Top Adhesive Peel Off Strength : 10~70g

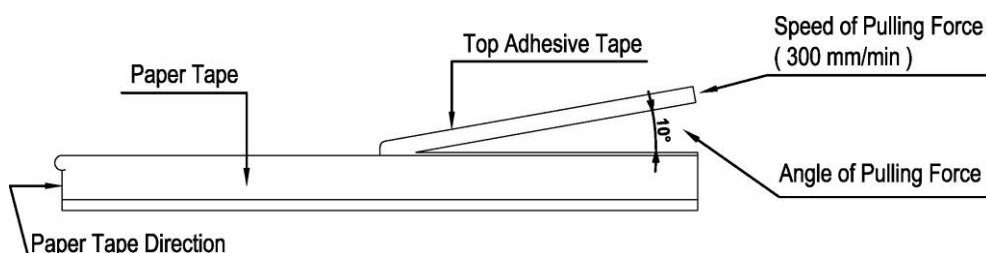

■ Package

Inner Box Size	
Reel	Size H(mm)
1	13
2	24
3	36
5	60
10	113

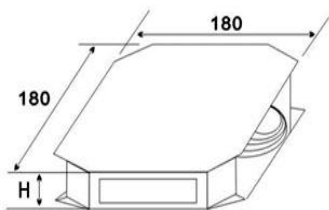

External Box Size			
Contain (Kpcs)	Length (mm)	Width (mm)	Height (mm)
25K	180	180	60
50K	180	180	110
150K	430	200	200
300K	400	400	200

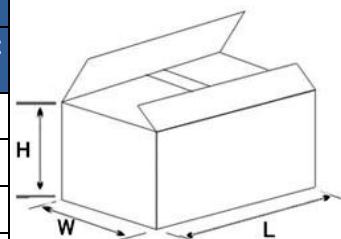

■ Storage Data :

Storage time at the environment temp: $25\pm 5^{\circ}\text{C}$ & humidity: $60\pm 20\%$ is valid for one year from the date of delivery.



CRA-Series Thick Film Array Chip Resistor Product Specifications

Document No.	S-10-12-02-03
Released Date	2019/01/03
Page No.	6/8

● Reliability Test and Requirement

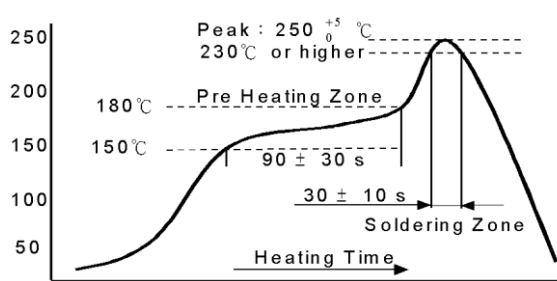
Test Item	Test Method	Procedure	Requirements
Temperature Coefficient of Resistance (T.C.R)	JIS C 5201-1 clause 4.8	-55°C or +155°C, 25°C is the reference temperature	Refer to Ratings
Short Time Overload	JIS C 5201-1 clause 4.13	General : 2.5 times RCWV or Max. Overload voltage whichever is less for 5 seconds. High Power : 2.5 times RCWV or Max. Overload voltage whichever is less for 2 seconds.	1% : $\pm(1.0\%+0.05\Omega)$ 5% : $\pm(2.0\%+0.10\Omega)$
IR Reflow	Sony SS-00254	 <p>The graph shows a temperature profile for IR reflow. The y-axis is temperature in °C (50 to 250) and the x-axis is Heating Time. Key points include: a pre-heating zone at 150°C for 90 ± 30 s; a peak temperature of 250 $^{+5}_0$ °C (230°C or higher); and a soldering zone at 180°C for 30 ± 10 s.</p>	1% : $\pm(1.0\%+0.05\Omega)$ 5% : $\pm(1.0\%+0.05\Omega)$
Leaching	Sony SS-00254-9	260±5°C for 30 seconds.	>95% Coverage
Soldering Heat	JIS C 5201-1 clause 4.18	260±5°C for 10 seconds.	1% : $\pm(0.5\%+0.05\Omega)$ 5% : $\pm(1.0\%+0.05\Omega)$
Temperature Cycling	JIS C 5201-1 clause 4.19	-55°C to +155°C, 5 cycles	1% : $\pm(0.5\%+0.05\Omega)$ 5% : $\pm(1.0\%+0.10\Omega)$
Electric Iron	Sony SS-00254-5	Preheating temperature : 350±10°C Electric iron preheating time : 3+1/-0 sec	1% : $\pm(1.0\%+0.05\Omega)$ 5% : $\pm(1.0\%+0.05\Omega)$
Resistance to Solvent	JIS C 5201-1 clause 4.29	The tested resistor be immersed into isopropyl alcohol of 20~25°C for 60 secs. Then the resistor is left in the room for 48 hrs.	1% : $\pm(0.5\%+0.05\Omega)$ 5% : $\pm(0.5\%+0.05\Omega)$
Load Life in Humidity	JIS C 5201-1 clause 4.24	40±2°C, 90~95% R.H. RCWV or Max. working voltage whichever is less for 1000 hrs with 1.5 hrs "ON" and 0.5 hr "OFF" .	1% : $\pm(1.0\%+0.05\Omega)$ 5% : $\pm(2.0\%+0.05\Omega)$
Load Life (Endurance)	JIS C 5201-1 clause 4.25	70±2°C, RCWV or Max. working voltage whichever is less for 1000 hrs with 1.5 hrs "ON" and 0.5 hr "OFF" .	1% : $\pm(1.0\%+0.05\Omega)$ 5% : $\pm(3.0\%+0.10\Omega)$
Insulation Resistance	JIS C 5201-1 clause 4.6	100V for 1 minute.	$\geq 10G\Omega$

● **General Information**

■ **Recommend Land Pattern Design (For Reflow Soldering)**

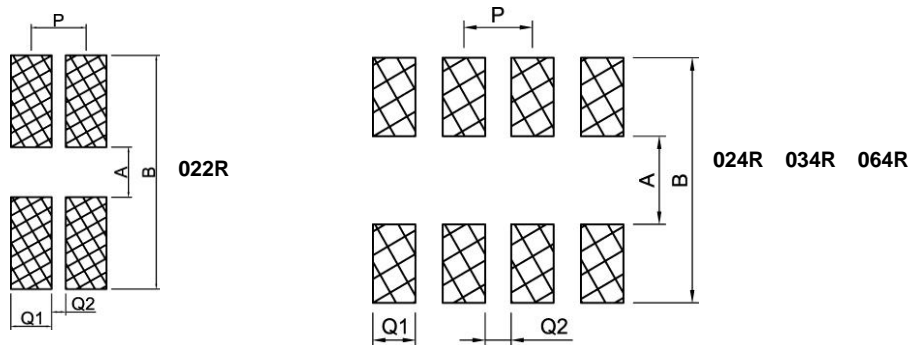

■ **Dimension**

Unit: mm

Type	022R	024R	034R	064R
Item				
A	0.50	0.50	1.00	2.00
B	2.00	2.00	2.60	4.75
P	0.67	0.50	0.80	1.30
Q1	0.33	0.28	0.40	0.90
Q2	0.34	0.22	0.40	0.375

■ **Performance Characteristics**

■ **Power Derating Curve**

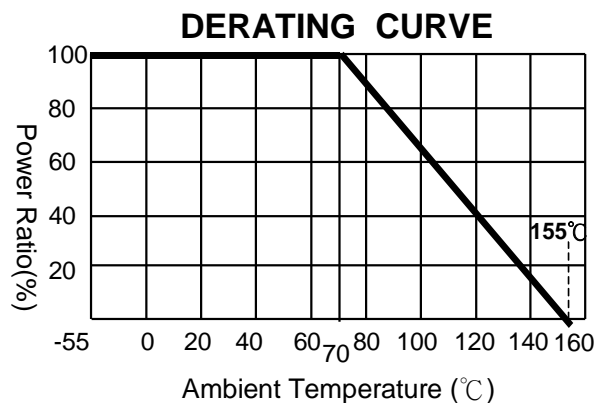

Power rating or current rating is in the case based on continuous full-load at ambient temperature of 70°C. For operation at ambient temperature in excess of 70°C, the load should be derated in accordance with figure of derating Curve.



CRA-Series Thick Film Array Chip Resistor Product Specifications

Document No.	S-10-12-02-03
Released Date	2019/01/03
Page No.	8/8

■ Voltage Rating or Current Rating

Resistance Range: $\geq 1 \Omega$

Rated Voltage: The resistor shall have a DC continuous working voltage or a RMS AC continuous working voltage at commercial-line frequency and wave form corresponding to the power rating, as determined formula as following:

$$E(RCWV) = \sqrt{P \times R}$$

E=Rated voltage(V)

P=Power rating(W)

R=Nominal resistance(Ω)

■ Equipments Applicable:

Our company's products are produced under low temperature processing applicable to IR reflow surface mounting devices. It is comparatively not applicable to wave soldering which will possibly cause the risk ablating the element protection layer and the front conductor and cause the drift of the resistance value and ablation of the markings.

■ Product Testing Method:

Our products are tested with our company's tapping & testing equipments by using four-feet probe to touch at the back of both electrodes. Supposed different testing points or methods are requested, please advise beforehand and customized-made production is available.

■ Standard Resistance Values in a Decade

Marking code:

- 5%: marking code, please refer to E24 data
Ex: 120K, The marking code is 124 in E24
- Note: Array resistors 1%&5% code is the same.
- Note: jumper zero ohm resistor marking code is one 「0」 (except type below 022R).

X-ON Electronics

Largest Supplier of Electrical and Electronic Components

Click to view similar products for [Resistor Networks & Arrays](#) category:

Click to view products by [Ever Ohms](#) manufacturer:

Other Similar products are found below :

[CS6600552K000B8768](#) [CSC06A0122K0GEJ](#) [CSC08A01470KGEK](#) [M8340105K1002FGD03](#) [M8340106MA010FHD03](#)
[M8340107K1471FGD03](#) [M8340108K1001FCD03](#) [M8340108K2402GGD03](#) [M8340108K3240FGD03](#) [M8340108K3242FGD03](#)
[M8340108K3322FCD03](#) [M8340108K4991FGD03](#) [M8340108K6192FGD03](#) [M8340108K6202GGD03](#) [M8340109K2002FCD03](#)
[M8340109M4701GCD03](#) [EXB-24N121JX](#) [EXB-24N330JX](#) [EXB-24N470JX](#) [EXB-A10E102J](#) [EXB-A10E104J](#) [744C083101JTR](#) [EXB-](#)
[U14360JX](#) [EXB-U18240JX](#) [EXB-U18390JX](#) [MDP1603100KGE04](#) [PRA100I2-1KBWNW](#) [GUS-SS4-BLF-01-1002-G](#)
[ACAS06S0830339P100](#) [ACAS06S0830343P100](#) [ACAS06S0830344P100](#) [RM2012A-102/104-PBVW10](#) [RM2012A-102503-PBVW10](#)
[RM2012A-502104-PBVW10](#) [RM3216B-102302-PBVW10](#) [L091S102LF](#) [ACAS06S0830341P100](#) [ACAS06S0830342P100](#)
[ACAS06S0830345P100](#) [EXB-14V300JX](#) [EXB-U14220JX](#) [EXB-U14470JX](#) [EXB-U18330JX](#) [EXB-V4N100JV](#) [EXB-V8V220GV](#) [PRA100I2-](#)
[10KBWN](#) [PRA100I4-10KBWN](#) [CSC09A014K70JEK](#) [M8340102M4701JAD04](#) [M8340105K1002GGD03](#)