

Fusible Chip Resistor — FCR Series

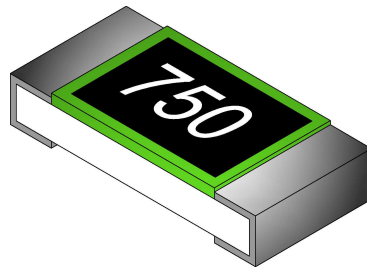

Features

- The accurate fusibility is applicable to safety circuits in the wide range of electronic sets.
- Small in size, light in weight.
- Low temperature coefficient.(under ± 600 PPM/ $^{\circ}$ C)
- Noncombustible insulated coat.
- May treat as the general resistance use.

Type Dimension

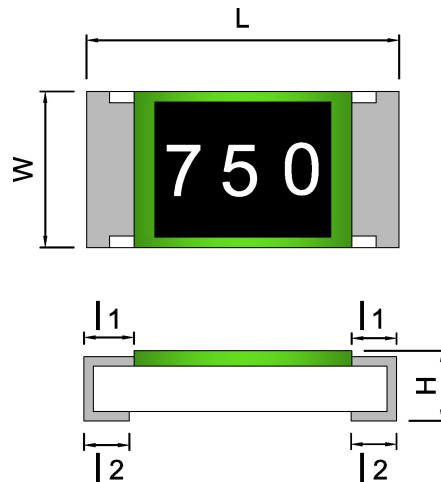

Dimension

Unit : mm

| TYPE | L | W | H | l ₁ | l ₂ |
|---------|-------------|-------------|-------------|----------------|----------------|
| FCR0402 | 1.00 ± 0.10 | 0.50 ± 0.05 | 0.30 ± 0.05 | 0.15 ± 0.10 | 0.20 ± 0.10 |
| FCR0603 | 1.60 ± 0.20 | 0.80 ± 0.15 | 0.40 ± 0.10 | 0.30 ± 0.20 | 0.30 ± 0.10 |
| FCR0805 | 2.00 ± 0.20 | 1.25 ± 0.15 | 0.50 ± 0.15 | 0.30 ± 0.15 | 0.40 ± 0.15 |
| FCR1206 | 3.05 ± 0.10 | 1.60 ± 0.20 | 0.55 ± 0.15 | 0.40 ± 0.20 | 0.50 ± 0.20 |
| FCR1210 | 3.05 ± 0.10 | 2.50 ± 0.20 | 0.55 ± 0.15 | 0.50 ± 0.20 | 0.50 ± 0.20 |
| FCR2010 | 5.00 ± 0.20 | 2.50 ± 0.20 | 0.55 ± 0.10 | 0.60 ± 0.20 | 0.60 ± 0.20 |
| FCR2512 | 6.30 ± 0.20 | 3.20 ± 0.20 | 0.55 ± 0.10 | 0.60 ± 0.20 | 0.60 ± 0.20 |

■ Power Characteristic

| Item Type | Rated Power at 70°C | Max Hold-Off Voltage | Fusing Time & Min. Fusing Power | Resistance Range | T.C.R. (PPM/°C) | Standard Tolerance (%) |
|--------------|------------------------|-------------------------|------------------------------------|---------------------|---|------------------------------|
| FCR0402 | 0.063W | 50V | < 30 sec at 2.5W | 1Ω~1KΩ | 1Ω~47Ω (±600PPM) 48Ω~470Ω (±400PPM) 471Ω~1KΩ (±200PPM) | ±5%,10% (1%,2% available) |
| FCR0603 | 0.1W | 100V | < 30 sec at 3W | | | |
| FCR0805 | 0.125W | 150V | < 30 sec at 3.25W | | | |
| FCR1206 | 0.25W | 200V | < 30 sec at 5W | | | |
| FCR1210 | 0.33W | 250V | < 30 sec at 7.5W | | | |
| FCR2010 | 0.5W | 300V | < 30 sec at 11.25W | | | |
| FCR2512 | 1W | 400V | < 30 sec at 15W | | | |

- For non-standard parts, please contact our sales dept.
- Operating Temperature Range : -55°C ~ +155°C.

■ Parts Number Explanation

■ Example:

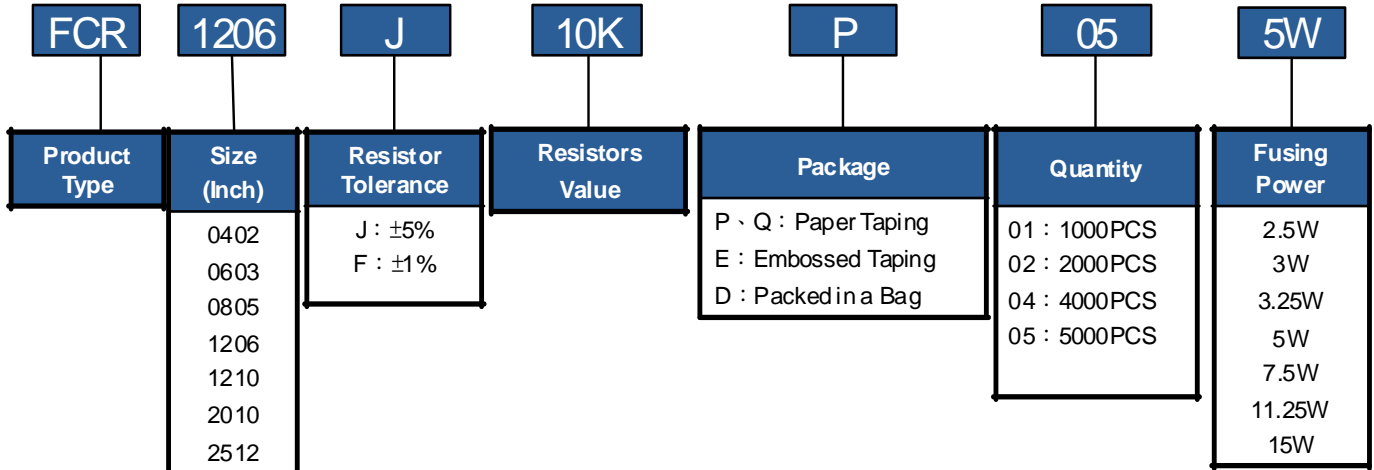

■ Appendix For SMD Chip Resistor

● Packaging Information

◆ For All Series

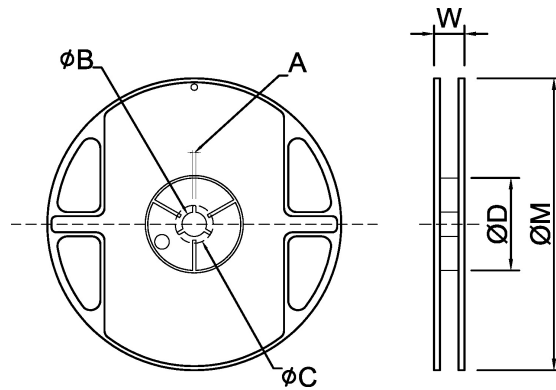

■ Dimension

Unit: mm

| TYPE | SIZE | | A | ϕB | ϕC | ϕD | W | ϕM |
|----------------------|------|----------|---------|----------|----------|----------|----------|----------|
| 0402 | 7" | 10K/Reel | 2.0±0.5 | 13.5±1.0 | 21±1.0 | 60±1.0 | 11.5±2.0 | 178±2.0 |
| | 13" | 40K/Reel | 2.0±0.5 | 13.5±1.0 | 21±1.0 | 100±1.0 | 11.5±2.0 | 330±2.0 |
| | 13" | 50K/Reel | 2.0±0.5 | 13.5±1.0 | 21±1.0 | 100±1.0 | 11.5±2.0 | 330±2.0 |
| 0603 0805 1206 | 7" | 5K/Reel | 2.0±0.5 | 13.5±1.0 | 21±1.0 | 60±1.0 | 11.5±2.0 | 178±2.0 |
| | 10" | 10K/Reel | 2.0±0.5 | 13.5±1.0 | 21±1.0 | 100±1.0 | 11.5±2.0 | 254±2.0 |
| | 13" | 20K/Reel | 2.0±0.5 | 13.5±1.0 | 21±1.0 | 100±1.0 | 11.5±2.0 | 330±2.0 |
| 1210 | 7" | 5K/Reel | 2.0±0.5 | 13.5±1.0 | 21±1.0 | 60±1.0 | 11.5±2.0 | 178±2.0 |
| 2010 2512 | 7" | 4K/Reel | 2.0±0.5 | 13.5±1.0 | 21±1.0 | 60±1.0 | 16.0±2.0 | 178±2.0 |

■ Tapping Specification

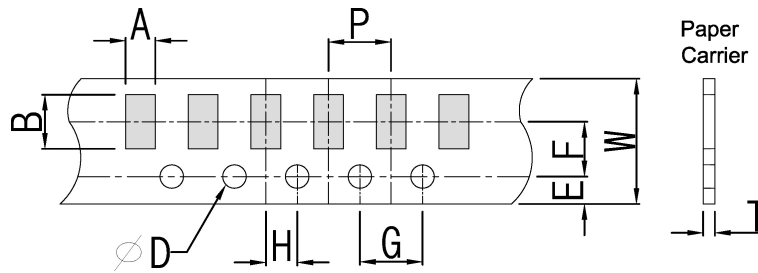

■ Dimension

Unit: mm

| Packaging | Type | A | B | W | E | F | G | H | T | ϕD | P |
|------------|------|-----------|-----------|----------|-----------|----------|----------|----------|-----------|---------------------|---------|
| Paper Type | 0402 | 0.70±0.10 | 1.20±0.10 | 8.0±0.20 | 1.75±0.10 | 3.5±0.05 | 4.0±0.10 | 2.0±0.05 | 0.45±0.10 | 1.50 +0.10 -0 | 2.0±0.1 |
| | 0603 | 1.05±0.20 | 1.80±0.20 | 8.0±0.20 | 1.75±0.10 | 3.5±0.05 | 4.0±0.10 | 2.0±0.05 | 0.60±0.10 | | 4.0±0.1 |
| | 0805 | 1.55±0.20 | 2.30±0.20 | 8.0±0.20 | 1.75±0.10 | 3.5±0.05 | 4.0±0.10 | 2.0±0.05 | 0.75±0.10 | | 4.0±0.1 |
| | 1206 | 1.90±0.20 | 3.50±0.20 | 8.0±0.20 | 1.75±0.10 | 3.5±0.05 | 4.0±0.10 | 2.0±0.05 | 0.75±0.10 | | 4.0±0.1 |
| | 1210 | 2.85±0.20 | 3.50±0.20 | 8.0±0.20 | 1.75±0.10 | 3.5±0.05 | 4.0±0.10 | 2.0±0.05 | 0.75±0.10 | | 4.0±0.1 |

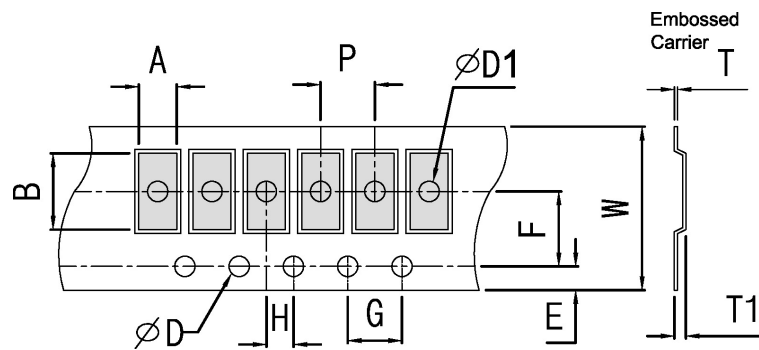

■ Dimension

Unit: mm

| Packaging | Type | A | B | W | E | F | G | H | T | ϕD | $\psi D1$ | T1 | P |
|---------------|------|-----------|-----------|---------|-----------|----------|----------|----------|-----------|---------------------|-----------|-----------|---------|
| Embossed Type | 2010 | 2.80±0.20 | 5.60±0.20 | 12±0.10 | 1.75±0.10 | 5.5±0.05 | 4.0±0.10 | 2.0±0.05 | 0.23±0.10 | 1.50 +0.10 -0 | 1.50±0.10 | 0.85±0.15 | 4.0±0.1 |
| | 2512 | 3.40±0.20 | 6.70±0.20 | 12±0.10 | 1.75±0.10 | 5.5±0.05 | 4.0±0.10 | 2.0±0.05 | 0.23±0.10 | | 1.50±0.10 | 0.85±0.15 | |

■ Packing Material Data / Storage Data

■ Front & Back Lead Dimension

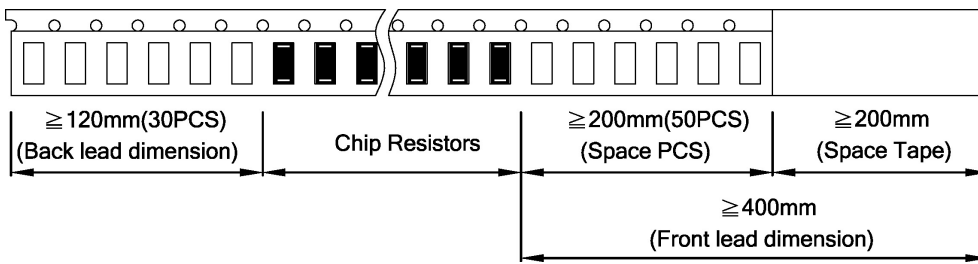

■ Top Adhesive Peel Off Strength : 10~70g

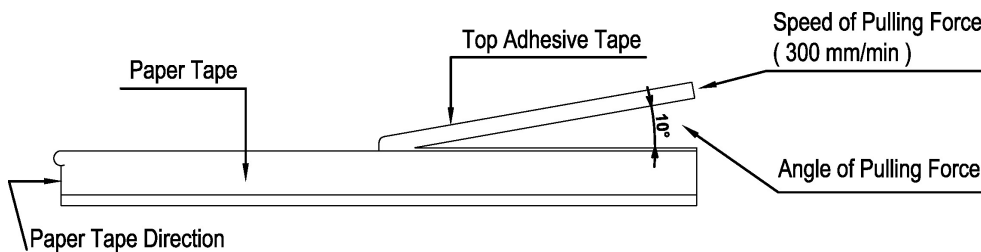

■ Package

| Inner Box Size | |
|----------------|------------|
| Reel | Size H(mm) |
| 1 | 13 |
| 2 | 24 |
| 3 | 36 |
| 5 | 60 |
| 10 | 113 |

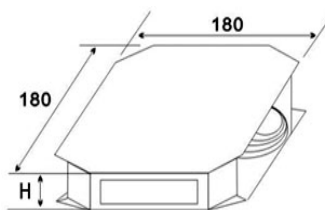

| External Box Size | | | |
|-------------------|-------------|------------|-------------|
| Contain (Kpcs) | Length (mm) | Width (mm) | Height (mm) |
| 25K | 180 | 180 | 60 |
| 50K | 180 | 180 | 110 |
| 150K | 430 | 200 | 200 |
| 300K | 400 | 400 | 200 |

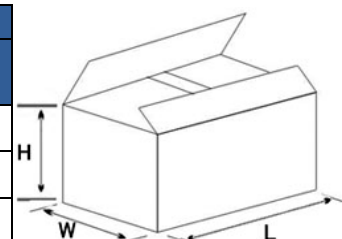

■ Storage Data :

Storage time at the environment temp: 25±5°C & humidity:60±20% is valid for one year from the date of delivery.

● Reliability Test and Requirement

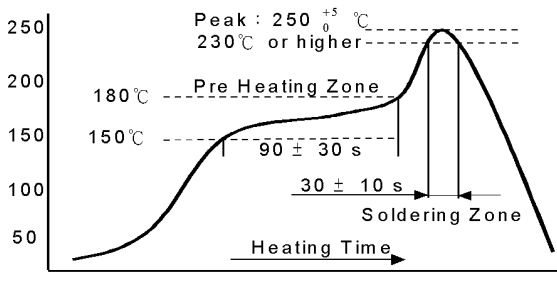
| Test Item | Test Method | Procedure | Requirements |
|---|--------------------------|---|--|
| Temperature Coefficient of Resistance (T.C.R) | JIS C 5201-1 clause 4.8 | -55°C or +155°C, 25°C is the reference temperature | Refer to Ratings |
| Short Time Overload | JIS C 5201-1 clause 4.13 | General : 2.5 times RCWV or Max. Overload voltage whichever is less for 5 seconds. High Power : 2.5 times RCWV or Max. Overload voltage whichever is less for 2 seconds. | ±1 : ±(1.0%+0.05Ω) ±5 : ±(2.0%+0.10Ω) |
| IR Reflow | Sony SS-00254 |  <p>The graph shows a temperature profile for IR reflow. The y-axis represents temperature in °C, ranging from 50 to 250. The x-axis represents time. Key points include: a pre-heating zone starting at 150°C and reaching 180°C; a soldering zone peaking at 250°C (with a note '230°C or higher'); and a heating time of 90 ± 30 s. A 30 ± 10 s interval is also marked within the soldering zone.</p> | ±1 : ±(1.0%+0.05Ω) ±5 : ±(1.0%+0.05Ω) |
| Leaching | Sony SS-00254-9 | 260±5°C for 30 seconds. | >95% Coverage |
| Soldering Heat | JIS C 5201-1 clause 4.18 | 260±5°C for 10 seconds. | ±1 : ±(0.5%+0.05Ω) ±5 : ±(1.0%+0.05Ω) |
| Temperature Cycling | JIS C 5201-1 clause 4.19 | -55°C to +155°C, 5 cycles | 0.1%、0.5%、1% : ±(0.5%+0.05Ω) 2%、5% : ±(1.0%+0.10Ω) |
| Electric Iron | Sony SS-00254-5 | Preheating temperature : 350±10°C Electric iron preheating time : 3+1/-0 sec | ±1 : ±(1.0%+0.05Ω) ±5 : ±(1.0%+0.05Ω) |
| Resistance to Solvent | JIS C 5201-1 clause 4.29 | The tested resistor be immersed into isopropyl alcohol of 20~25°C for 60 secs. Then the resistor is left in the room for 48 hrs. | ±1 : ±(0.5%+0.05Ω) ±5 : ±(0.5%+0.05Ω) |
| Load Life in Humidity | JIS C 5201-1 clause 4.24 | 40±2°C, 90~95% R.H. RCWV or Max. working voltage whichever is less for 1000 hrs with 1.5 hrs "ON" and 0.5 hr "OFF" . | 0.1%、0.5%、1% : ±(1.0%+0.05Ω) 2%、5% : ±(2.0%+0.05Ω) Value <1Ω : ±(2.0%+0.05Ω) |
| Load Life (Endurance) | JIS C 5201-1 clause 4.25 | 70±2°C, RCWV or Max. working voltage whichever is less for 1000 hrs with 1.5 hrs "ON" and 0.5 hr "OFF" . | 0.1%、0.5%、1% : ±(1.0%+0.05Ω) 2%、5% : ±(3.0%+0.10Ω) Value <1Ω : ±(3.0%+0.10Ω) |
| Insulation Resistance | JIS C 5201-1 clause 4.6 | 100V for 1 minute. | ≥10GΩ |
| Terminal Bending Strength | JIS C 5201-1 clause 4.33 | Bending once for 5 seconds D : 0402、0603、0805=5mm 1206、1210、1812=3mm 1218、2010、2512、2030=2mm | ±1 : ±(1.0%+0.05Ω) ±5 : ±(1.0%+0.05Ω) |

● General Information

■ Recommend Land Pattern Design (For Reflow Soldering)

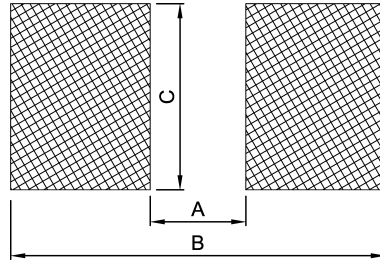

■ Dimension

Unit: mm

| Item \ Type | 0402 | 0603 | 0805 | 1206 | 1210 | 2010 | 2512 |
|-------------|------|------|------|------|------|------|------|
| A | 0.60 | 0.80 | 1.30 | 2.20 | 2.00 | 3.80 | 4.90 |
| B | 1.60 | 2.40 | 2.90 | 4.20 | 4.40 | 6.60 | 8.10 |
| C | 0.70 | 1.00 | 1.45 | 1.80 | 2.70 | 2.70 | 3.40 |

■ Performance Characteristics

■ Power Derating Curve

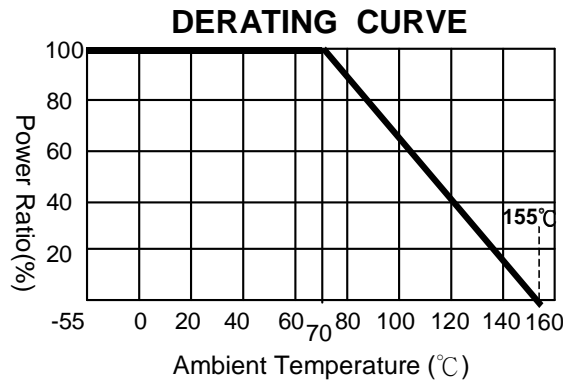

Power rating or current rating is in the case based on continuous full-load at ambient temperature of 70°C. For operation at ambient temperature in excess of 70°C, the load should be derated in accordance with figure of derating Curve.

■ Voltage Rating or Current Rating

Resistance Range: $\geq 1\Omega$

Rated Voltage: The resistor shall have a DC continuous working voltage or a RMS AC continuous working voltage at commercial-line frequency and wave form corresponding to the power rating, as determined formula as following:

$$E(RCWV) = \sqrt{P \times R}$$

E=Rated voltage(V)

P=Power rating(W)

R=Nominal resistance(Ω)

■ Operation and Storage Temperature

| | MIN | MAX |
|-----------------------|-------|------|
| Operation temperature | -55°C | 70°C |
| Storage temperature | 20°C | 30°C |
| Storage humidity | 40% | 80% |

■ Equipments Applicable:

Our company's products are produced under low temperature processing applicable to IR reflow surface mounting devices. It is comparatively not applicable to wave soldering which will possibly cause the risk ablating the element protection layer and the front conductor and cause the drift of the resistance value and ablation of the markings.

■ Product Testing Method:

Our products are tested with our company's tapping & testing equipments by using four-foot probe to touch at the back of both electrodes. Supposed different testing points or methods are requested, please advise beforehand and customized-made production is available.

■ 0603 E-96 Multiplier Code

| Code | A | B | C | D | E | F | G | H | X | Y | Z |
|------------|-----------------|-----------------|-----------------|-----------------|-----------------|-----------------|-----------------|-----------------|------------------|------------------|------------------|
| Multiplier | 10 ⁰ | 10 ¹ | 10 ² | 10 ³ | 10 ⁴ | 10 ⁵ | 10 ⁶ | 10 ⁷ | 10 ⁻¹ | 10 ⁻² | 10 ⁻³ |

CODING FORMULA

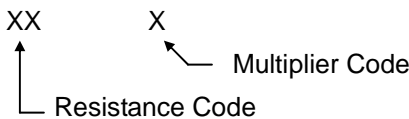

Example: $10.2K\Omega = \frac{102}{10^2} \Omega = 02C$
 $33.2\Omega = \frac{332}{10^1} \Omega = 51X$

■ 0603 Standard E-96 Values and 0603 Resistance Codes

| | | | | | | | | | | | | | | | | | | | | | | | | |
|---------|-----|-----|-----|-----|-----|-----|-----|-----|-----|-----|-----|-----|-----|-----|-----|-----|-----|-----|-----|-----|-----|-----|-----|-----|
| R-Value | 100 | 102 | 105 | 107 | 110 | 113 | 115 | 118 | 121 | 124 | 127 | 130 | 133 | 137 | 140 | 143 | 147 | 150 | 154 | 158 | 162 | 165 | 169 | 174 |
| Code | 01 | 02 | 03 | 04 | 05 | 06 | 07 | 08 | 09 | 10 | 11 | 12 | 13 | 14 | 15 | 16 | 17 | 18 | 19 | 20 | 21 | 22 | 23 | 24 |
| R-Value | 178 | 182 | 187 | 191 | 196 | 200 | 205 | 210 | 215 | 221 | 226 | 232 | 237 | 243 | 249 | 255 | 261 | 267 | 274 | 280 | 287 | 294 | 301 | 309 |
| Code | 25 | 26 | 27 | 28 | 29 | 30 | 31 | 32 | 33 | 34 | 35 | 36 | 37 | 38 | 39 | 40 | 41 | 42 | 43 | 44 | 45 | 46 | 47 | 48 |
| R-Value | 316 | 324 | 332 | 340 | 348 | 357 | 365 | 374 | 383 | 392 | 402 | 412 | 422 | 432 | 442 | 453 | 464 | 475 | 487 | 499 | 511 | 523 | 536 | 549 |
| Code | 49 | 50 | 51 | 52 | 53 | 54 | 55 | 56 | 57 | 58 | 59 | 60 | 61 | 62 | 63 | 64 | 65 | 66 | 67 | 68 | 69 | 70 | 71 | 72 |
| R-Value | 562 | 576 | 590 | 604 | 619 | 634 | 649 | 665 | 681 | 698 | 715 | 732 | 750 | 768 | 787 | 806 | 825 | 845 | 866 | 887 | 909 | 931 | 953 | 976 |
| Code | 73 | 74 | 75 | 76 | 77 | 78 | 79 | 80 | 81 | 82 | 83 | 84 | 85 | 86 | 87 | 88 | 89 | 90 | 91 | 92 | 93 | 94 | 95 | 96 |

■ Standard Resistance Values in a Decade

Marking code:

1%: marking code, please refer to E96 and E24 data form as below

Ex: 120K, The marking code is 1203 in E24

121K, The marking code is 1213 in E96

5%: marking code, please refer to E24 data form as below

Ex: 120K, The marking code is 124 in E24

Note: 0402 series resistor has no marking code.

Type: 0603 1% marking code, please refer to E-96 multiplier code.

| E192 | E96 | E48 | E192 | E96 | E48 | E192 | E96 | E48 | E192 | E96 | E48 | E192 | E96 | E48 | |
|------|-----|-----|------|-----|-----|------|-----|-----|------|-----|-----|------|-----|-----|----|
| 100 | 100 | 100 | 169 | 169 | 169 | 287 | 287 | 287 | 487 | 487 | 487 | 825 | 825 | 825 | |
| 101 | | | 172 | | | 291 | | | 493 | | | 835 | | | |
| 102 | 102 | | 174 | 174 | | 294 | 294 | | 499 | 499 | | 845 | 845 | | |
| 104 | | | 176 | | | 298 | | | 505 | | | 856 | | | |
| 105 | 105 | 105 | 178 | 178 | 178 | 301 | 301 | 301 | 511 | 511 | 511 | 866 | 866 | 866 | |
| 106 | | | 180 | | | 305 | | | 517 | | | 876 | | | |
| 107 | 107 | | 182 | 182 | | 309 | 309 | | 523 | 523 | | 887 | 887 | | |
| 109 | | | 184 | | | 312 | | | 530 | | | 898 | | | |
| 110 | 110 | 110 | 187 | 187 | 187 | 316 | 316 | 316 | 536 | 536 | 536 | 909 | 909 | 909 | |
| 111 | | | 189 | | | 320 | | | 542 | | | 920 | | | |
| 113 | 113 | | 191 | 191 | | 324 | 324 | | 549 | 549 | | 931 | 931 | | |
| 114 | | | 193 | | | 328 | | | 556 | | | 942 | | | |
| 115 | 115 | 115 | 196 | 196 | 196 | 332 | 332 | 332 | 562 | 562 | 562 | 953 | 953 | 953 | |
| 117 | | | 198 | | | 336 | | | 569 | | | 965 | | | |
| 118 | 118 | | 200 | 200 | | 340 | 340 | | 576 | 576 | | 976 | 976 | | |
| 120 | | | 203 | | | 344 | | | 583 | | | 988 | | | |
| 121 | 121 | 121 | 205 | 205 | 205 | 348 | 348 | 348 | 590 | 590 | 590 | | | | |
| 123 | | | 208 | | | 352 | | | 597 | | | | | | |
| 124 | 124 | | 210 | 210 | | 357 | 357 | | 604 | 604 | | E24 | E12 | E6 | E3 |
| 126 | | | 213 | | | 361 | | | 612 | | | 10 | 10 | 10 | 10 |
| 127 | 127 | 127 | 215 | 215 | 215 | 365 | 365 | 365 | 619 | 619 | 619 | 11 | | | |
| 129 | | | 218 | | | 370 | | | 626 | | | 12 | 12 | | |
| 130 | 130 | | 221 | 221 | | 374 | 374 | | 634 | 634 | | 13 | | | |
| 132 | | | 223 | | | 379 | | | 642 | | | 15 | 15 | 15 | |
| 133 | 133 | 133 | 226 | 226 | 226 | 383 | 383 | 383 | 649 | 649 | 649 | 16 | | | |
| 135 | | | 229 | | | 388 | | | 657 | | | 18 | 18 | | |
| 137 | 137 | | 232 | 232 | | 392 | 392 | | 665 | 665 | | 20 | | | |
| 138 | | | 234 | | | 397 | | | 673 | | | 22 | 22 | 22 | 22 |
| 140 | 140 | 140 | 237 | 237 | 237 | 402 | 402 | 402 | 681 | 681 | 681 | 24 | | | |
| 142 | | | 240 | | | 407 | | | 690 | | | 27 | 27 | | |
| 143 | 143 | | 243 | 243 | | 412 | 412 | | 698 | 698 | | 30 | | | |
| 145 | | | 246 | | | 417 | | | 706 | | | 33 | 33 | 33 | |
| 147 | 147 | 147 | 249 | 249 | 249 | 422 | 422 | 422 | 715 | 715 | 715 | 36 | | | |
| 149 | | | 252 | | | 427 | | | 723 | | | 39 | 39 | | |
| 150 | 150 | | 255 | 255 | | 432 | 432 | | 732 | 732 | | 43 | | | |
| 152 | | | 258 | | | 437 | | | 741 | | | 47 | 47 | 47 | 47 |
| 154 | 154 | 154 | 261 | 261 | 261 | 442 | 442 | 442 | 750 | 750 | 750 | 51 | | | |
| 156 | | | 264 | | | 448 | | | 759 | | | 56 | 56 | | |
| 158 | 158 | | 267 | 267 | | 453 | 453 | | 768 | 768 | | 62 | | | |
| 160 | | | 271 | | | 459 | | | 777 | | | 68 | 68 | 68 | |
| 162 | 162 | 162 | 274 | 274 | 274 | 464 | 464 | 464 | 787 | 787 | 787 | 75 | | | |
| 164 | | | 277 | | | 470 | | | 796 | | | 82 | 82 | | |
| 165 | 165 | | 280 | 280 | | 475 | 475 | | 806 | 806 | | 91 | | | |
| 167 | | | 284 | | | 481 | | | 816 | | | | | | |

According to IEC publication 63

Revision : June 30, 2017

X-ON Electronics

Largest Supplier of Electrical and Electronic Components

Click to view similar products for [Thick Film Resistors - SMD category](#):

Click to view products by [Ever Ohms manufacturer](#):

Other Similar products are found below :

[CR-05FL7--150R](#) [CR-05FL7--19K6](#) [CR-05FL7--243R](#) [CR-05FL7--40K2](#) [CR-05FL7--698K](#) [CR-12FP4--324R](#) [CR-12JP4--680R](#)
[M55342K06B1E78RS3](#) [M55342K06B6E19RWL](#) [M55342K06B6E81RS3](#) [M55342M05B200DRWB](#) [M55342M06B4K70MS3](#) [MC0603-511-](#)
[JTW](#) [742C083750JTR](#) [MCR01MZPF1202](#) [MCR01MZPF1601](#) [MCR01MZPF1800](#) [MCR01MZPF6201](#) [MCR01MZPF9102](#) [MCR01MZPJ113](#)
[MCR01MZPJ121](#) [MCR01MZPJ125](#) [MCR01MZPJ751](#) [MCR03EZHJ103](#) [MCR03EZPFX2004](#) [MCR03EZPJ270](#) [MCR03EZPJ821](#)
[MCR10EZPF1102](#) [MCR18EZPJ330](#) [RC0603F1473CS](#) [RC0603F150CS](#) [RC1005F1152CS](#) [RC1005F1182CS](#) [RC1005F1372CS](#)
[RC1005F183CS](#) [RC1005F1911CS](#) [RC1005F1912CS](#) [RC1005F203CS](#) [RC1005F2052CS](#) [RC1005F241CS](#) [RC1005F2431CS](#)
[RC1005F3011CS](#) [RC1005F303CS](#) [RC1005F4321CS](#) [RC1005F4642CS](#) [RC1005F471CS](#) [RC1005F4751CS](#) [RC1005F5621CS](#)
[RC1005F6041CS](#) [RC1005J106CS](#)