



QR-Series Automotive Chip Resistor Product Specifications

Document No. S-10-12-20-02

Released Date 2019/03/12

Page No. 1/13

■ Automotive Chip Resistor — QR Series

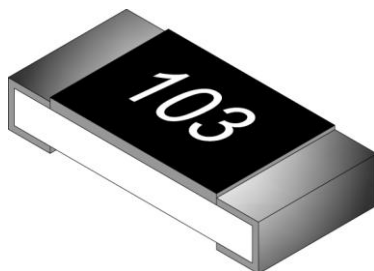

■ Application

- Automotive electronics
- Navigation equipment, TPMS
- Heating, Ventilating and Air conditioning
- Indoor lighting, Central door locking, Wiper module

■ Features

- Small size and light weight
- Reliability, high quality
- CCD visual quality inspection

■ Type Dimension

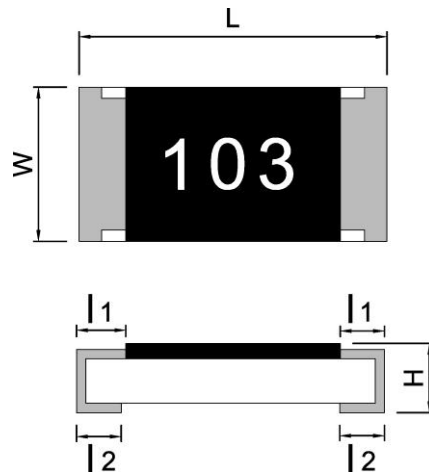

QR0402 / QR0603 / QR0805 / QR1206
QR1210 / QR1812 / QR2010 / QR1218
QR2512

TYPE	L	W	H	l ₁	l ₂
QR0402	1.00 ± 0.10	0.50 ± 0.05	0.30 ± 0.05	0.15 ± 0.10	0.20 ± 0.10
QR0603	1.60 ± 0.20	0.80 ± 0.15	0.40 ± 0.10	0.30 ± 0.20	0.30 ± 0.10
QR0805	2.00 ± 0.20	1.25 ± 0.15	0.50 ± 0.15	0.30 ± 0.15	0.40 ± 0.15
QR1206	3.05 ± 0.10	1.60 ± 0.20	0.55 ± 0.15	0.40 ± 0.20	0.50 ± 0.20
QR1210	3.05 ± 0.10	2.50 ± 0.20	0.55 ± 0.15	0.50 ± 0.20	0.50 ± 0.20
QR1812	4.50 ± 0.10	3.10 ± 0.20	0.55 ± 0.05	0.55 ± 0.20	0.70 ± 0.20
QR2010	5.00 ± 0.20	2.50 ± 0.20	0.55 ± 0.10	0.60 ± 0.20	0.60 ± 0.20
QR1218	3.10 ± 0.10	4.60 ± 0.10	0.55 ± 0.05	0.40 ± 0.20	0.50 ± 0.20
QR2512	6.30 ± 0.20	3.20 ± 0.20	0.55 ± 0.10	0.60 ± 0.20	0.60 ± 0.20



QR-Series Automotive Chip Resistor Product Specifications

Document No. S-10-12-20-02

Released Date 2019/03/12

Page No. 3/13

■ Standard Electrical Specifications

Type	Item	Rated Power at 70°C	Max Working Voltage	Max Overload Voltage	T.C.R. (PPM/°C)	Resistance Range		
						B(±0.1%) D(±0.5%)	F(±1%) G±(2%)	J(±5%) K(±10%)
QR0402		0.063 W	50V	100V	±400	-	1Ω~9.9Ω	
					±100	-	10Ω~990Ω	
					±100	10Ω~1MΩ	1KΩ~10MΩ	
QR0603		0.1 W	75V	150V	±400	-	1Ω~9.9Ω	
					±200	-	10Ω~10MΩ	
					±100	10Ω~1MΩ	10Ω~10MΩ	-
QR0805		0.125 W	150V	300V	±400	-	1Ω~9.9Ω	
					±200	-	10Ω~10MΩ	
					±100	10Ω~1MΩ	10Ω~10MΩ	-
QR1206		0.25 W	200V	400V	±400	-	1Ω~9.9Ω	
					±200	-	10Ω~10MΩ	
					±100	10Ω~1MΩ	10Ω~10MΩ	-
QR1210		0.5 W	200V	400V	±400	-	1Ω~9.9Ω	
					±200	-	10Ω~10MΩ	
					±100	10Ω~1MΩ	10Ω~10MΩ	-
QR1812		0.75 W	200V	400V	±400	-	1Ω~9.9Ω	
					±200	-	10Ω~10MΩ	
					±100	10Ω~1MΩ	10Ω~10MΩ	-
QR2010		0.75 W	200V	400V	±400	-	1Ω~9.9Ω	
					±200	-	10Ω~10MΩ	
					±100	10Ω~1MΩ	10Ω~10MΩ	-
QR1218		1 W	200V	400V	±400	-	1Ω~9.9Ω	
					±200	-	10Ω~10MΩ	
					±100	10Ω~1MΩ	10Ω~10MΩ	-
QR2512		1 W	200V	400V	±400	-	1Ω~9.9Ω	
					±200	-	10Ω~10MΩ	
					±100	10Ω~1MΩ	10Ω~10MΩ	-

- For non-standard parts, please contact our sales dept.
- Operating Temperature Range : -55°C ~ +155°C.



QR-Series Automotive Chip Resistor Product Specifications

Document No.	S-10-12-20-02
Released Date	2019/03/12
Page No.	4/13

Type	0402	0603	0805	1206	1210	1812	2010	1218	2512
Jumper Resistance Value	50mΩ Max								
Jumper Rated Current	1A				2A				

● Automotive Low Ohm Chip Resistor
 ■ Standard Electrical Specifications

Item Type	Rated Power at 70℃	Rated Voltage Range	Max Overload Voltage	T.C.R. (PPM/℃)	Resistance Range (mΩ)
					F(±1%)、J(±5%)
QR0402	0.063 W	0.17~0.25V	0.624 V	±800	470~990
QR0603	0.1 W	0.1~0.31V	0.775 V	±800	100~330
				±600	331~990
QR0805	0.125 W	0.04~0.35V	0.875 V	±1800	10~50
				±800	51~100
				±600	101~990
QR1206	0.25 W	0.05~0.5V	1.25 V	±1800	10~50
				±800	51~100
				±600	101~990
QR1210	0.5 W	0.07~0.7V	1.75 V	±1800	10~50
				±800	51~100
				±600	101~990
QR1812	0.75 W	0.08~0.8V	2.15 V	±1800	10~50
				±800	51~100
				±600	101~990
QR2010	0.75 W	0.08~0.8V	2.15 V	±1800	10~50
				±800	51~100
				±600	101~990
QR1218	1 W	0.1~0.99V	2.475V	±800	10~50
				±400	51~990
QR2512	1 W	0.1~0.99V	2.475V	±1800	10~50
				±800	51~100
				±600	101~990

- For non-standard parts, please contact our sales dept.
- Operating Temperature Range : -55℃ ~ +155℃.



QR-Series Automotive Chip Resistor Product Specifications

Document No.	S-10-12-20-02
Released Date	2019/03/12
Page No.	5/13

● Automotive High Ohm Chip Resistor

■ Standard Electrical Specifications

Item Type	Rated Power at 70 °C	Max Working Voltage	Max Overload Voltage	T.C.R. (PPM/°C)	Resistance Range	
					F(±1%)	J(±5%)
QR0402	0.063 W	50V	100V	±200	10.1 MΩ ~ 54 MΩ	10.1 MΩ ~ 100 MΩ
QR0603	0.1 W	75V	150V			
QR0805	0.125 W	150V	300V			
QR1206	0.25 W	200V	400V			
QR1210	0.5 W					
QR1812	0.75 W					
QR2010	0.75 W					
QR1218	1 W					
QR2512	1 W					

- For non-standard parts, please contact our sales dept.
- Operating Temperature Range : -55°C ~ +155°C.

■ Parts Number Explanation

■ Example:

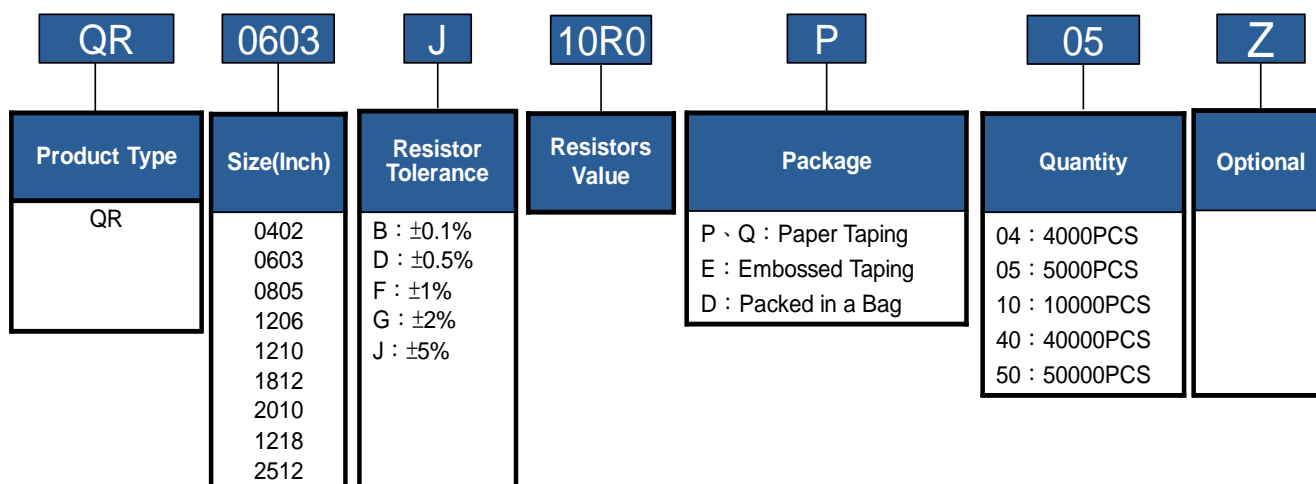

■ Appendix For SMD Chip Resistor

● Packaging Information

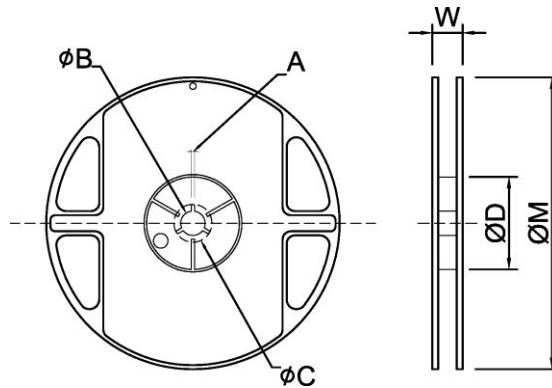

■ Dimension

Unit: mm

TYPE	SIZE		A	φB	φC	φD	W	φM
0402	7"	10K/Reel	2.0±0.5	13.5±1.0	21±1.0	60±1.0	11.5±2.0	178±2.0
	13"	40K/50K Reel	2.0±0.5	13.5±1.0	21±1.0	100±1.0	11.5±2.0	330±2.0
0603/0805/1206/ 1210	7"	5K/Reel	2.0±0.5	13.5±1.0	21±1.0	60±1.0	11.5±2.0	178±2.0
0603/0805 /1206	10"	10K/Reel	2.0±0.5	13.5±1.0	21±1.0	100±1.0	11.5±2.0	254±2.0
	13"	20K/Reel	2.0±0.5	13.5±1.0	21±1.0	100±1.0	11.5±2.0	330±2.0
2010/2512/1812/1218	7"	4K/Reel	2.0±0.5	13.5±1.0	21±1.0	60±1.0	16.0±2.0	178±2.0



QR-Series Automotive Chip Resistor Product Specifications

Document No.	S-10-12-20-02
Released Date	2019/03/12
Page No.	7/13

■ Tapping Specification



■ Dimension

Unit: mm

Packaging	Type	A	B	W	E	F	G	H	T	ϕD	P
Paper Type	0402	0.70±0.1	1.20±0.1	8.0±0.2	1.75±0.1	3.5±0.05	4.0±0.1	2.0±0.05	0.45±0.1	1.50 ^{+0.10} ₋₀	2.0±0.1
	0603	1.05±0.2	1.80±0.2	8.0±0.2	1.75±0.1	3.5±0.05	4.0±0.1	2.0±0.05	0.60±0.1		4.0±0.1
	0805	1.55±0.2	2.30±0.2	8.0±0.2	1.75±0.1	3.5±0.05	4.0±0.1	2.0±0.05	0.75±0.1		
	1206	1.90±0.2	3.50±0.2	8.0±0.2	1.75±0.1	3.5±0.05	4.0±0.1	2.0±0.05	0.75±0.1		
	1210	2.85±0.2	3.50±0.2	8.0±0.2	1.75±0.1	3.5±0.05	4.0±0.1	2.0±0.05	0.75±0.1		

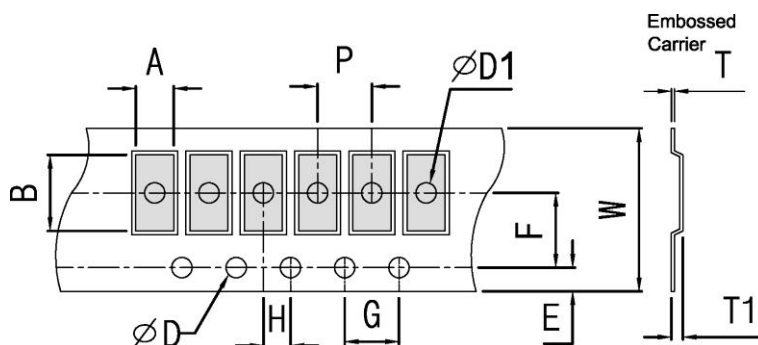

■ Dimension

Unit: mm

Packaging	Type	A	B	W	E	F	G	H	T	ϕD	$\phi D1$	T1	P
Embossed Type	2010	2.80±0.2	5.60±0.2	12±0.1	1.75±0.1	5.5±0.05	4.0±0.1	2.0±0.05	0.23±0.1	1.50 ^{+0.10} ₋₀	1.50±0.1	0.85±0.15	4.0±0.1
	2512	3.40±0.2	6.70±0.2	12±0.1	1.75±0.1	5.5±0.05	4.0±0.1	2.0±0.05	0.23±0.1		1.50±0.1	0.85±0.15	
	1812/ 1218	3.30±0.2	4.60±0.2	12±0.1	1.75±0.1	5.5±0.05	4.0±0.1	2.0±0.05	0.23±0.1		1.50±0.1	0.85±0.15	

■ Packing Material Data/Storage Data

■ Front & Back Lead Dimension



■ Top Adhesive Peel Off Strength : 10~70g



■ Package

Inner Box Size	
Reel	Size H(mm)
1	13
2	24
3	36
5	60
10	113

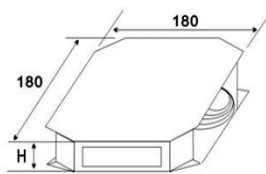

External Box Size			
Contain (Kpcs)	Length (mm)	Width (mm)	Height (mm)
25K	180	180	60
50K	180	180	110
150K	430	200	200
300K	400	400	200



■ Storage Data :

Storage time at the environment temp: $25\pm 5^\circ\text{C}$ & humidity: $60\pm 20\%$ is valid for one year from the date of delivery.



QR-Series Automotive Chip Resistor Product Specifications

Document No.	S-10-12-20-02
Released Date	2019/03/12
Page No.	9/13

● Reliability Test and Requirement

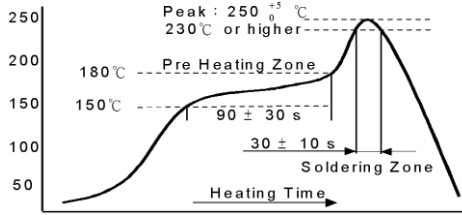
Test Item	Test Method	Procedure	Requirements
Temperature Coefficient of Resistance (T.C.R)	JIS C 5201-1 clause 4.8	-55°C or +155°C, 25°C is the reference temperature	Refer to Ratings
Short Time Overload	JIS C 5201-1 clause 4.13	General : 2.5 times RCWV or Max. Overload voltage whichever is less for 5 seconds.	±1 : ±(1.0%+0.05 Ω) ±5 : ±(2.0%+0.1 Ω) Value <1Ω : ±(2.0%+0.1 Ω)
IR Reflow	Sony SS-00254	 <p>The graph shows a temperature profile for IR reflow. The y-axis is temperature in °C (50 to 250) and the x-axis is heating time. Key points include: Pre Heating Zone (150°C to 180°C), a peak of 250 ± 5°C (230°C or higher), and a Soldering Zone (30 ± 10 s) at approximately 230°C. A 90 ± 30 s dwell time is also indicated.</p>	±1 : ±(1.0%+0.05 Ω) ±5 : ±(1.0%+0.05 Ω)
Leaching	Sony SS-00254-9	260±5°C for 30 seconds.	>95% Coverage
Soldering Heat	JIS C 5201-1 clause 4.18	260±5°C for 10 seconds.	±1 : ±(0.5%+0.05 Ω) ±5 : ±(1.0%+0.05 Ω) Value <1Ω : ±(1.0%+0.05 Ω)
Temperature Cycling	JIS C 5201-1 clause 4.19	-55°C to +155°C, 5 cycles	0.1%、0.5%、1% : ±(0.5%+0.05 Ω) 2%、5% : ±(1.0%+0.10 Ω) Value <1Ω : ±(1.0%+0.10 Ω)
Electric Iron	Sony SS-00254-5	Preheating temperature : 350±10°C Electric iron preheating time : 3+1/-0 sec	±1 : ±(1.0%+0.05 Ω) ±5 : ±(1.0%+0.05 Ω) Value <1Ω : ±(1.0%+0.05 Ω)
Resistance to Solvent	JIS C 5201-1 clause 4.29	The tested resistor be immersed into isopropyl alcohol of 20~25°C for 60 secs. Then the resistor is left in the room for 48 hrs.	±1 : ±(0.5%+0.05 Ω) ±5 : ±(0.5%+0.05 Ω) Value <1Ω : ±(1.0%+0.05 Ω)
Load Life in Humidity	JIS C 5201-1 clause 4.24	40±2°C, 90~95% R.H. RCWV or Max. working voltage whichever is less for 1000 hrs with 1.5 hrs "ON" and 0.5 hr "OFF" .	0.1%、0.5%、1% : ±(1.0%+0.05 Ω) 2%、5% : ±(2.0%+0.05 Ω) Value <1Ω : ±(2.0%+0.05 Ω)
Load Life (Endurance)	JIS C 5201-1 clause 4.25	70±2°C, RCWV or Max. working voltage whichever is less for 1000 hrs with 1.5 hrs "ON" and 0.5 hr "OFF" .	0.1%、0.5%、1% : ±(1.0%+0.05 Ω) 2%、5% : ±(3.0%+0.10 Ω) Value <1Ω : ±(3.0%+0.10 Ω)
Insulation Resistance	JIS C 5201-1 clause 4.6	100V for 1 minute.	≥ 10G Ω
Terminal Bending Strength	JIS C 5201-1 clause 4.33	Bending once for 5 seconds D : 0402、0603、0805=5mm 1206、1210、1812=3mm 2010、2512、1218 =2mm	±1 : ±(1.0%+0.05 Ω) ±5 : ±(1.0%+0.05 Ω)



QR-Series Automotive Chip Resistor Product Specifications

Document No.	S-10-12-20-02
Released Date	2019/03/12
Page No.	10/13

AEC-Q200 test			
Test Item	Test Method	Procedure	Requirements
Temperature Cycling	JESD22 Method JA-104	1000 Cycles (-55°C to +125°C) Measurement at 24± 4 hours after test conclusion.	0.1%、0.5%、1% : ±(0.5%+0.05 Ω) 2%、5% : ±(1.0%+0.10 Ω)
Resistance to Solvent	MIL-STD-202 Method 215	Add Aqueous wash chemical-OKEM clean or equivalent.	1% : ±(0.5%+0.05 Ω) 5% : ±(0.5%+0.05 Ω)
Biased Humidity	MIL-STD-202 Method 103	1000 hours 85°C/85%RH. 10% of operation power.	0.1%、0.5%、1% : ±(1.0%+0.05 Ω) 2%、5% : ±(3.0%+0.05 Ω)
High Temperature Exposure (Storage)	MIL-STD-202 Method 108	1000 hrs. T=125°C.	0.1%、0.5%、1% : ±(0.5%+0.05 Ω) 2%、5% : ±(2.0%+0.05 Ω)
Operation Life	MIL-STD-202 Method 108	125°C RCWV or Max.working voltage whichever is less for 1000 hrs with 1.5 hrs"ON" and 0.5hr "OFF" Please refer to the Power Derating Curve .	0.1%、0.5%、1% : ±(1.0%+0.05 Ω) 2%、5% : ±(3.0%+0.10 Ω)
External Visual	MIL-STD-883 Method 2009	Electrical test not required. Inspect device construction, marking and workmanship.	—
Mechanical Shock	MIL-STD-202 Method 213	Impact acceleration : 1500g Pulse duration : 0.5ms Number of shocks : 30 shocks(5 shocks for each face)	±1 : ±(1.0%+0.05 Ω) ±5 : ±(2.0%+0.1 Ω)
Vibration	MIL-STD-202 Method 204	5 g's for 20min., 12 cycles each of 3 orientations.	±1 : ±(1.0%+0.05 Ω) ±5 : ±(2.0%+0.1 Ω)
ESD	AEC-Q200- 002 or ISO/DIS 10605	0402 / 0603 : 1KV 0805 and above : 2KV	For the product %
Solderability	J-STD-002	(1) 4 hrs 155°C dry heat (2) 260±5°C 10 sec.	±1 : ±(0.5%+0.05 Ω) ±5 : ±(1.0%+0.05 Ω)
Terminal Strength (SMD)	AEC Q200-006	0402 / 0603 : 8N 0805 and above : 17.7N	No broken
Board Flex	AEC Q200-005	Beading once for 60 seconds	±1 : ±(1.0%+0.05 Ω) ±5 : ±(1.0%+0.05 Ω)

● **General Information**

■ **Recommend Land Pattern Design**

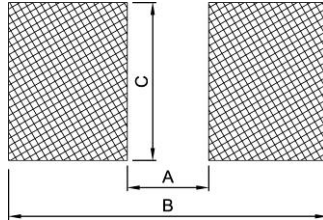

■ **Dimension**

Unit: mm

Item \ Type	0201	0402	0603	0805	1206	1210	1812	2010	2512
A	0.25	0.60	0.80	1.30	2.20	2.00	3.11	3.80	4.90
B	1.10	1.60	2.40	2.90	4.20	4.40	5.91	6.60	8.10
C	0.32	0.70	1.00	1.40	1.70	2.70	3.00	2.70	3.40

■ **Performance Characteristics**

■ **Power Derating Curve**

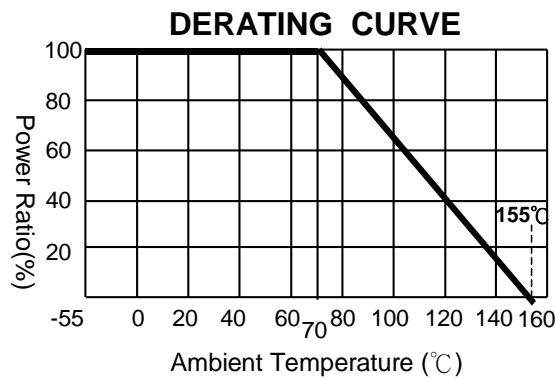

Power rating or current rating is in the case based on continuous full-load at ambient temperature of 70°C. For operation at ambient temperature in excess of 70°C, the load should be derated in accordance with figure of derating Curve.

■ **Voltage Rating or Current Rating**

Resistance Range: $\geq 1 \Omega$

Rated Voltage: The resistor shall have a DC continuous working voltage or a RMS AC continuous working voltage at commercial-line frequency and wave form corresponding to the power rating, as determined formula as following:

$$E(RCWV) = \sqrt{P \times R}$$

E=Rated voltage(V)
P=Power rating(W)
R=Nominal resistance(Ω)



QR-Series Automotive Chip Resistor Product Specifications

Document No.	S-10-12-20-02
Released Date	2019/03/12
Page No.	13/13

■ Standard Resistance Values in a Decade

Marking code:

- 1%: marking code, please refer to E96 and E24 data form as below
 Ex: 120K, The marking code is 1203 in E24
 121K, The marking code is 1213 in E96
- 5%: marking code, please refer to E24 data form as below
 Ex: 120K, The marking code is 124 in E24
- Note: 0402 series resistor has no marking code.
- Type: 0603 1% marking code, please refer to E-96 multiplier code.
- **Note: jumper zero ohm resistor marking code is one 「0」 (except type below 0402).**

E192	E96	E48	E192	E96	E48	E192	E96	E48	E192	E96	E48	E192	E96	E48	
100	100	100	169	169	169	287	287	287	487	487	487	825	825	825	
101			172			291			493			835			
102	102		174	174		294	294		499	499		845	845		
104			176			298			505			856			
105	105	105	178	178	178	301	301	301	511	511	511	866	866	866	
106			180			305			517			876			
107	107		182	182		309	309		523	523		887	887		
109			184			312			530			898			
110	110	110	187	187	187	316	316	316	536	536	536	909	909	909	
111			189			320			542			920			
113	113		191	191		324	324		549	549		931	931		
114			193			328			556			942			
115	115	115	196	196	196	332	332	332	562	562	562	953	953	953	
117			198			336			569			965			
118	118		200	200		340	340		576	576		976	976		
120			203			344			583			988			
121	121	121	205	205	205	348	348	348	590	590	590				
123			208			352			597						
124	124		210	210		357	357		604	604		E24	E12	E6	E3
126			213			361			612			10	10	10	10
127	127	127	215	215	215	365	365	365	619	619	619	11			
129			218			370			626			12	12		
130	130		221	221		374	374		634	634		13			
132			223			379			642			15	15	15	
133	133	133	226	226	226	383	383	383	649	649	649	16			
135			229			388			657			18	18		
137	137		232	232		392	392		665	665		20			
138			234			397			673			22	22	22	22
140	140	140	237	237	237	402	402	402	681	681	681	24			
142			240			407			690			27	27		
143	143		243	243		412	412		698	698		30			
145			246			417			706			33	33	33	
147	147	147	249	249	249	422	422	422	715	715	715	36			
149			252			427			723			39	39		
150	150		255	255		432	432		732	732		43			
152			258			437			741			47	47	47	47
154	154	154	261	261	261	442	442	442	750	750	750	51			
156			264			448			759			56	56		
158	158		267	267		453	453		768	768		62			
160			271			459			777			68	68	68	
162	162	162	274	274	274	464	464	464	787	787	787	75			
164			277			470			796			82	82		
165	165		280	280		475	475		806	806		91			
167			284			481			816						

According to IEC publication 63

X-ON Electronics

Largest Supplier of Electrical and Electronic Components

Click to view similar products for [Thick Film Resistors - SMD category](#):

Click to view products by [Ever Ohms manufacturer](#):

Other Similar products are found below :

[CR-05FL7--150R](#) [CR-05FL7--19K6](#) [CR-05FL7--243R](#) [CR-05FL7--40K2](#) [CR-05FL7--698K](#) [CR-12FP4--324R](#) [CR-12JP4--680R](#)
[M55342K06B1E78RS3](#) [M55342K06B6E19RWL](#) [M55342K06B6E81RS3](#) [M55342M05B200DRWB](#) [M55342M06B4K70MS3](#) [MC0603-511-](#)
[JTW](#) [742C083750JTR](#) [MCR01MZPF1202](#) [MCR01MZPF1601](#) [MCR01MZPF1800](#) [MCR01MZPF6201](#) [MCR01MZPF9102](#) [MCR01MZPJ113](#)
[MCR01MZPJ121](#) [MCR01MZPJ125](#) [MCR01MZPJ751](#) [MCR03EZHJ103](#) [MCR03EZPFX2004](#) [MCR03EZPJ270](#) [MCR03EZPJ821](#)
[MCR10EZPF1102](#) [MCR18EZPJ330](#) [RC0603F1473CS](#) [RC0603F150CS](#) [RC1005F1152CS](#) [RC1005F1182CS](#) [RC1005F1372CS](#)
[RC1005F183CS](#) [RC1005F1911CS](#) [RC1005F1912CS](#) [RC1005F203CS](#) [RC1005F2052CS](#) [RC1005F241CS](#) [RC1005F2431CS](#)
[RC1005F3011CS](#) [RC1005F303CS](#) [RC1005F4321CS](#) [RC1005F4642CS](#) [RC1005F471CS](#) [RC1005F4751CS](#) [RC1005F5621CS](#)
[RC1005F6041CS](#) [RC1005J106CS](#)