



**TRC Series Consumer-grade Thin Film
Chip Resistor Engineering Product
Specifications**

Document No. P-10-01-179-01

Revision Date 2022/04/28

Page No. 1/8

Consumer-grade Thin Film Chip Resistor — TRC Series

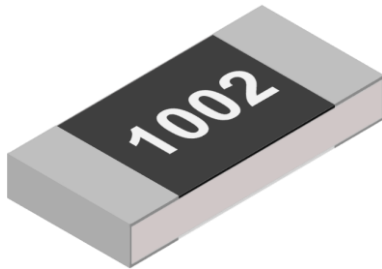

Top view

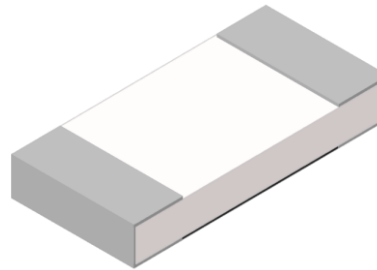

Bottom view

Applications

- Computer & relative products
- Communication devices
- Consumer electronics

Features

- Tolerance to $\pm 0.5\%$
- TCR to $\pm 25 \text{ ppm}/^\circ\text{C}$
- Halogen free and lead free
- RoHS compliant

Parts Number Explanation

Example:

TRC	0805	F	10K0	P	05	25	Z
Product Type	Size (Inch)	Tolerance	Resistance	Package	Quantity (PCS)	TCR (ppm/°C)	Optional
TRC Series Consumer-grade Thin Film Chip Resistor	0402 0603 0805 1206	D : $\pm 0.5\%$ F : $\pm 1\%$	4 digits EX. 4R70 = 4.7 Ω 10R0 = 10 Ω 100R = 100 Ω 2K20 = 2.2 K Ω 332K = 332 K Ω 1M00 = 1 M Ω	P : Paper Taping (0603~1206) Q : Paper Taping (0402)	05 : 5000 10 : 10000 20 : 20000 40 : 40000 50 : 50000	25 : ± 25 50 : ± 50	Z : Default Code

Standard Electrical Specifications

項目 Item 型別 Type	額定功率 Rated Power at 70°C	最大工作電壓 Max Working Voltage	最大過負載電壓 Max Overload Voltage	溫度係數 T.C.R. (PPM/°C)	阻值範圍 Resistance Range	
					D ±0.5%	F ±1%
TRC0402	0.063W	50V	100V	±25 ±50	4.7 Ω ~ 220 KΩ	
TRC0603	0.1W	75V	150V	±25 ±50	2.49 Ω ~ 680 KΩ	
TRC0805	0.125W	150V	300V	±25 ±50	2.49 Ω ~ 1 MΩ	
TRC1206	0.25W	200V	400V	±25 ±50	2.49 Ω ~ 1.5 MΩ	

• Operating Temperature Range : -55°C ~ +155°C.

Construction

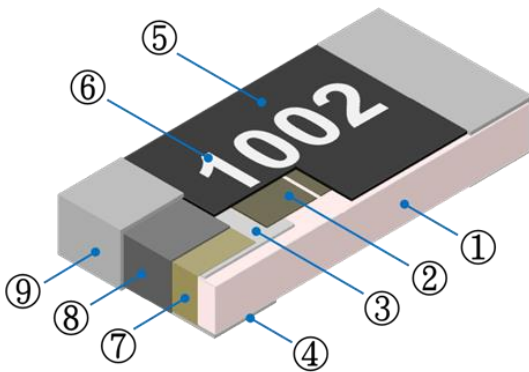

①	Alumina Substrate	④	Bottom Inner Electrode	⑦	Side Inner Electrode
②	Resistive Layer	⑤	Protective Overcoat	⑧	Nickel Barrier
③	Top Inner Electrode	⑥	Marking	⑨	Solder coating (Sn)

Dimensions

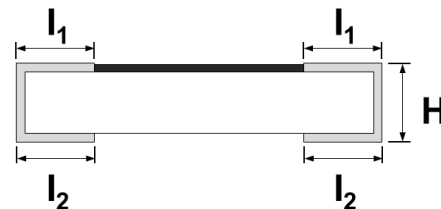
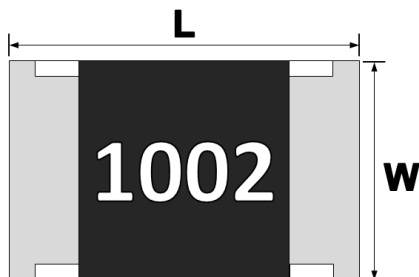

Unit : mm

TYPE	L	W	H	l ₁	l ₂
TRC0402	1.00 ± 0.10	0.50 ± 0.05	0.30 ± 0.05	0.20 ± 0.15	0.20 ± 0.10
TRC0603	1.60 ± 0.15	0.80 ± 0.10	0.45 ± 0.10	0.25 ± 0.20	0.30 ± 0.20
TRC0805	2.00 ± 0.15	1.25 ± 0.15	0.55 ± 0.10	0.30 ± 0.25	0.40 ± 0.20
TRC1206	3.10 ± 0.15	1.60 ± 0.15	0.55 ± 0.10	0.35 ± 0.25	0.50 ± 0.20



TRC Series Consumer-grade Thin Film Chip Resistor Engineering Product Specifications

Document No. P-10-01-179-01

Revision Date 2022/04/28

Page No. 3/8

■ Performance Characteristics

■ Power Derating Curve

The Operating Temperature Range: $-55^{\circ}\text{C} \sim +155^{\circ}\text{C}$.

Power rating is in the case based on continuous full-load at ambient temperature of 70°C . For operation at ambient temperature in excess of 70°C , the load should be derated in accordance with figure of derating Curve.

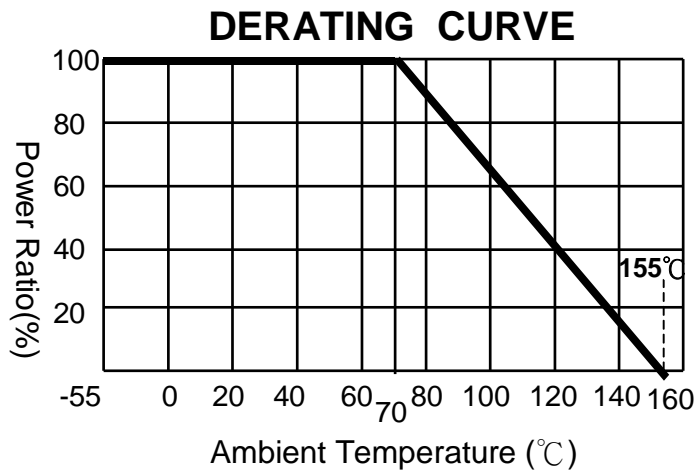

■ Rated Voltage

Resistance Range: $\geq 1\Omega$

Rated Voltage: The resistor shall have a DC continuous working voltage or a RMS AC continuous working voltage at commercial-line frequency and wave form corresponding to the power rating, as determined formula as following:

$$V = \sqrt{P \times R}$$

V = Rated voltage (V)

P = Rated power (W)

R = Nominal resistance (Ω)



**TRC Series Consumer-grade Thin Film
Chip Resistor Engineering Product
Specifications**

Document No. P-10-01-179-01

Revision Date 2022/04/28

Page No. 4/8

Reliability Tests and Requirements

Test Item	Test Method	Procedure	Requirements
Temperature Coefficient of Resistance (T.C.R)	JIS-C-5201-1 4.8 IEC-60115-1 4.8	At 25°C /+125°C, 25°C is the reference temperature	Refer to Standard Electrical Specifications
Short Time Overload	JIS-C-5201-1 4.13 IEC-60115-1 4.13	2.5 times RCWV or Max. Overload voltage whichever is less for 5 seconds.	±(0.5%+0.05Ω) No Visual damage
Insulation Resistance	JIS-C-5201-1 4.6 IEC-60115-1 4.6	Apply 100VDC for 1 minute.	≥ 10GΩ
Solderability	JIS-C-5201-1 4.17 IEC-60115-1 4.17	245±5°C for 3 seconds.	>95% Coverage No Visual damage
Resistance to Soldering Heat	JIS-C-5201-1 4.18 IEC-60115-1 4.18	260±5°C for 10 seconds.	±(0.5%+0.05Ω) No Visual damage
Leaching	JIS-C-5201-1 4.18 IEC-60068-2-58 8.2.1	260±5°C for 30 seconds.	>95% Coverage No Visual damage
Rapid Change of Temperature	JIS-C-5201-1 4.19 IEC-60115-1 4.19	-55°C to +155°C, 300 cycles	±(0.5%+0.05Ω) No Visual damage
High Temperature Exposure	JIS-C5201-1 4.25 IEC 60068-2-2	At 155±5°C for 1000 hours.	±(0.5%+0.05Ω)
Resistance to Solvent	JIS-C-5201-1 4.29	The tested resistor be immersed into isopropyl alcohol of 20~25°C for 60 secs. Then the resistor is left in the room for 48 hrs.	±(0.5%+0.05Ω) No Visual damage
Damp Heat with Load	JIS-C-5201-1 4.24 IEC-60115-1 4.24	40±2°C, 90~95% R.H. RCWV or Max. working voltage whichever is less for 1000 hrs with 1.5 hrs "ON" and 0.5 hr "OFF"	±(0.5%+0.05Ω)
Load Life (Endurance)	JIS-C-5201-1 4.25 IEC-60115-1 4.25.1	70±2°C, RCWV or Max. working voltage whichever is less for 1000 hrs with 1.5 hrs "ON" and 0.5 hr "OFF" .	±(0.5%+0.05Ω)
Bending Strength	JIS-C-5201-1 4.33 IEC-60115-1 4.33	Bending once for 5 seconds D : 0402、0603、0805 = 5mm 1206 = 3mm	±(0.5%+0.05Ω) No Visual damage

Recommended Customer Soldering Parameters

Wave solder Temperature condition

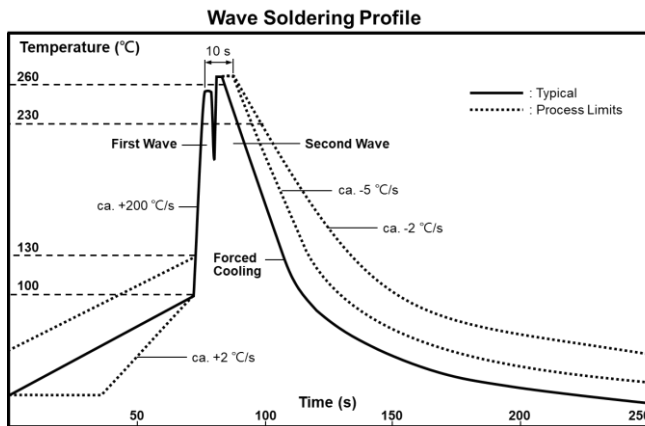

Solder reflow Temperature condition

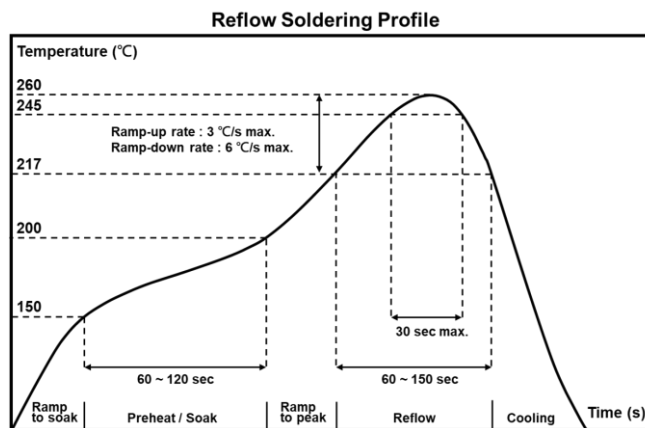

Rework temperature (hot air equipment) : 350°C, 3~5seconds

Recommended reflow methods

IR, vapor phase oven, hot air oven

If reflow temperatures exceed the recommended profile, devices may not meet the performance requirements.

Recommend Land Pattern Design

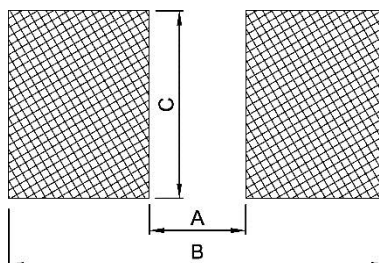

Unit: mm

Type	0402	0603	0805	1206
Item A	0.50	0.80	1.30	2.20
Item B	1.60	2.40	2.90	4.20
Item C	0.70	1.00	1.40	1.70



**TRC Series Consumer-grade Thin Film
Chip Resistor Engineering Product
Specifications**

Document No. P-10-01-179-01

Revision Date 2022/04/28

Page No. 7/8

■ Packaging Information

■ Reel Dimensions

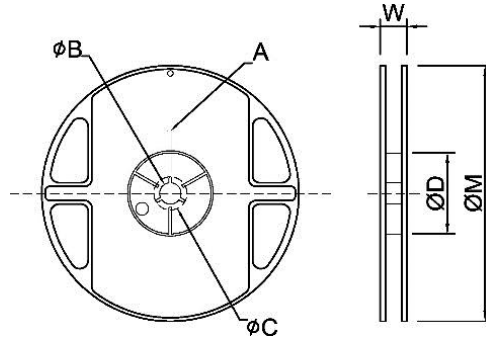

Unit: mm

TYPE	SIZE	SIZE	A	ΦB	ΦC	ΦD	W	ΦM
0402	7"	10K/Reel	2.0±0.5	13.5±1.0	21±1.0	60±1.0	11.5±2.0	178±2.0
0402	13"	40K/50K Reel	2.0±0.5	13.5±1.0	21±1.0	100±1.0	11.5±2.0	330±2.0
0603/0805/1206	7"	5K/Reel	2.0±0.5	13.5±1.0	21±1.0	60±1.0	11.5±2.0	178±2.0
0603/0805/1206	10"	10K/Reel	2.0±0.5	13.5±1.0	21±1.0	100±1.0	11.5±2.0	254±2.0
	13"	20K/Reel	2.0±0.5	13.5±1.0	21±1.0	100±1.0	11.5±2.0	330±2.0

■ Paper Tape Dimensions

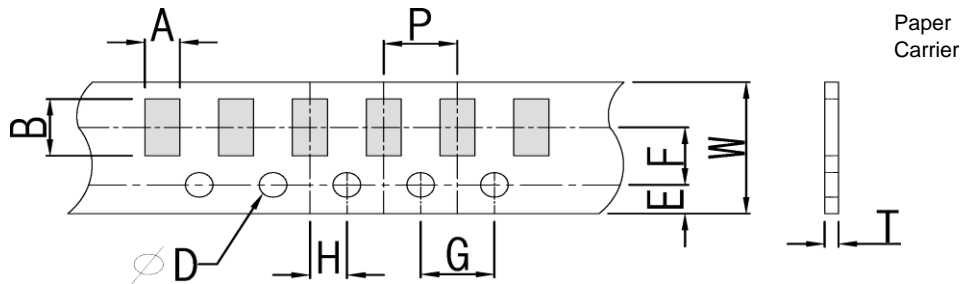

Unit: mm

Type	A	B	W	E	F	G	H	T	ΦD	P
0402	0.70±0.10	1.20±0.10	8.0±0.20	1.75±0.10	3.5±0.05	4.0±0.10	2.0±0.05	0.45±0.10	1.50 ^{+0.10} ₋₀	2.0±0.10
0603	1.05±0.20	1.80±0.20	8.0±0.20	1.75±0.10	3.5±0.05	4.0±0.10	2.0±0.05	0.60±0.10		4.0±0.10
0805	1.55±0.20	2.30±0.20	8.0±0.20	1.75±0.10	3.5±0.05	4.0±0.10	2.0±0.05	0.75±0.10		
1206	1.90±0.20	3.50±0.20	8.0±0.20	1.75±0.10	3.5±0.05	4.0±0.10	2.0±0.05	0.75±0.10		

■ Front & Back Lead Dimensions

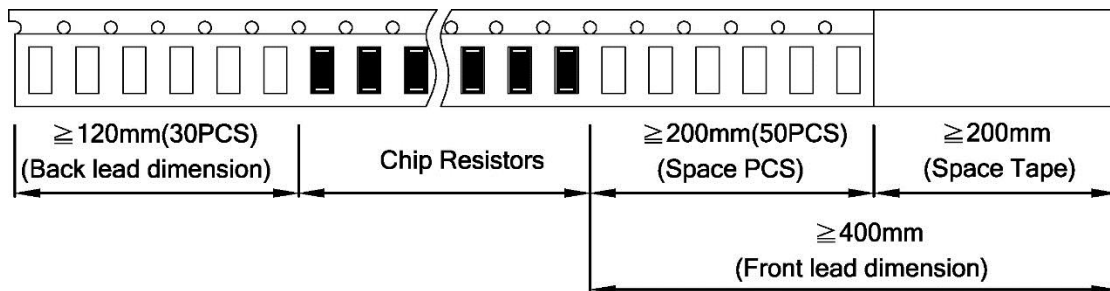

■ **Top Adhesive Peel Off Strength : 10~70g**

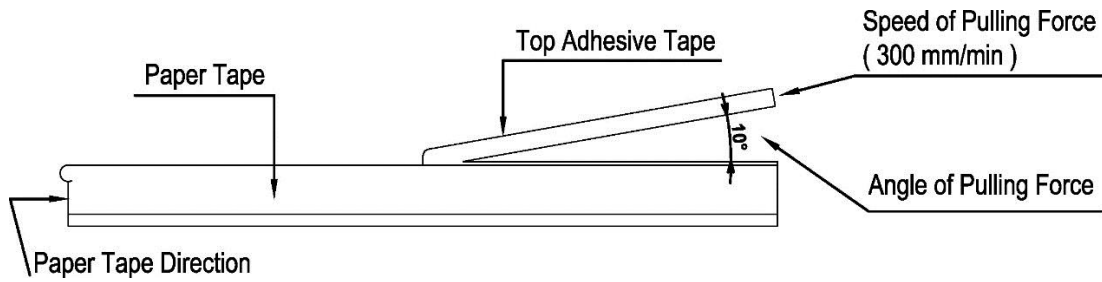

■ **Package**

Inner Box Size	
Reel	Size H(mm)
1	13
2	24
3	36
5	60
10	113

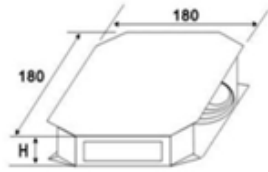

External Box Size			
Contain (Kpcs)	Length (mm)	Width (mm)	Height (mm)
25K	180	180	60
50K	180	180	110
150K	430	200	200
300K	400	400	200

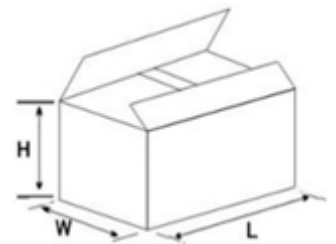

■ **Storage Data :**

Storage time at the environment temp: $25 \pm 5^\circ\text{C}$ & humidity: $60 \pm 20\%$ is valid for one year from the date of delivery.

X-ON Electronics

Largest Supplier of Electrical and Electronic Components

Click to view similar products for [Thick Film Resistors - SMD category](#):

Click to view products by [Ever Ohms manufacturer](#):

Other Similar products are found below :

[CR-05FL7--150R](#) [CR-05FL7--698K](#) [CR-12JP4--680R](#) [CRCW04021K20FKEE](#) [CRCW04028R20JNEE](#) [CRCW06032K10FKEC](#)
[CRCW06036K80FKEE](#) [M55342K03B499DRS6](#) [M55342K06B6E19RWL](#) [M55342K09B5D62RS6](#) [M55342M06B26E7RS3](#) [742C083750JTR](#)
[MCR01MZPF1202](#) [MCR01MZPF1601](#) [MCR01MZPF1800](#) [MCR01MZPF6201](#) [MCR01MZPF9102](#) [MCR01MZPJ121](#) [MCR01MZPJ125](#)
[MCR01MZPJ751](#) [MCR03EZHJ103](#) [MCR03EZPF2004](#) [MCR03EZPJ270](#) [MCR03EZPJ821](#) [MCR10EZPF1102](#) [MCR10EZPF2700](#)
[MCR18EZPJ330](#) [RC1005F1152CS](#) [RC1005F1372CS](#) [RC1005F1912CS](#) [RC1005F2052CS](#) [RC1005F3011CS](#) [RC1005F471CS](#)
[RC1005F4751CS](#) [RC1005F5621CS](#) [RC1005F6041CS](#) [RC1005J121CS](#) [RC1005J122CS](#) [RC1005J154CS](#) [RC1005J180CS](#) [RC1005J181CS](#)
[RC1005J202CS](#) [RC1005J391CS](#) [RC1005J560CS](#) [RC1005J683CS](#) [RC1005J823CS](#) [RC1608F1022CS](#) [RC1608F333CS](#) [RC1608F3651CS](#)
[RC1608F5110CS](#)