



**TRC Series Consumer-grade Thin Film
Chip Resistor Engineering Product
Specifications**

Document No. P-10-01-179-01

Revision Date 2022/04/28

Page No. 1/8

Consumer-grade Thin Film Chip Resistor — TRC Series

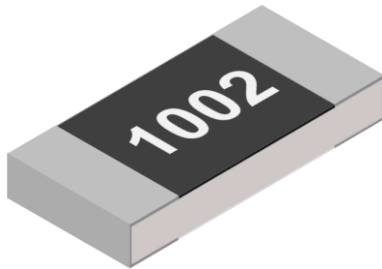

Top view

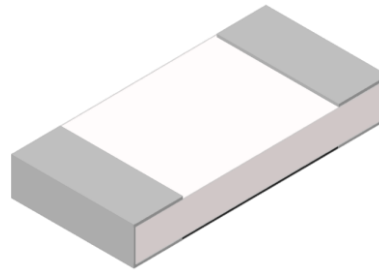

Bottom view

Applications

- Computer & relative products
- Communication devices
- Consumer electronics

Features

- Tolerance to $\pm 0.5\%$
- TCR to $\pm 25 \text{ ppm}/^\circ\text{C}$
- Halogen free and lead free
- RoHS compliant

Parts Number Explanation

Example:

TRC	0805	F	10K0	P	05	25	Z
Product Type	Size (Inch)	Tolerance	Resistance	Package	Quantity (PCS)	TCR (ppm/°C)	Optional
TRC Series Consumer-grade Thin Film Chip Resistor	0402 0603 0805 1206	D : $\pm 0.5\%$ F : $\pm 1\%$	4 digits EX. 4R70 = 4.7 Ω 10R0 = 10 Ω 100R = 100 Ω 2K20 = 2.2 K Ω 332K = 332 K Ω 1M00 = 1 M Ω	P : Paper Taping (0603~1206) Q : Paper Taping (0402)	05 : 5000 10 : 10000 20 : 20000 40 : 40000 50 : 50000	25 : ± 25 50 : ± 50	Z : Default Code

Standard Electrical Specifications

項目 Item 型別 Type	額定功率 Rated Power at 70°C	最大工作電壓 Max Working Voltage	最大過負載電壓 Max Overload Voltage	溫度係數 T.C.R. (PPM/°C)	阻值範圍 Resistance Range	
					D ±0.5%	F ±1%
TRC0402	0.063W	50V	100V	±25 ±50	4.7 Ω ~ 220 KΩ	
TRC0603	0.1W	75V	150V	±25 ±50	2.49 Ω ~ 680 KΩ	
TRC0805	0.125W	150V	300V	±25 ±50	2.49 Ω ~ 1 MΩ	
TRC1206	0.25W	200V	400V	±25 ±50	2.49 Ω ~ 1.5 MΩ	

• Operating Temperature Range : -55°C ~ +155°C.

Construction

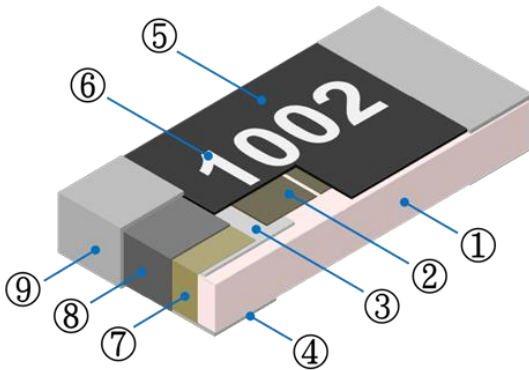

①	Alumina Substrate	④	Bottom Inner Electrode	⑦	Side Inner Electrode
②	Resistive Layer	⑤	Protective Overcoat	⑧	Nickel Barrier
③	Top Inner Electrode	⑥	Marking	⑨	Solder coating (Sn)

Dimensions

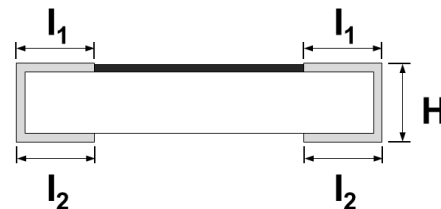
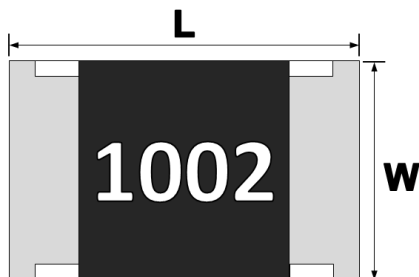

Unit : mm

TYPE	L	W	H	l ₁	l ₂
TRC0402	1.00 ± 0.10	0.50 ± 0.05	0.30 ± 0.05	0.20 ± 0.15	0.20 ± 0.10
TRC0603	1.60 ± 0.15	0.80 ± 0.10	0.45 ± 0.10	0.25 ± 0.20	0.30 ± 0.20
TRC0805	2.00 ± 0.15	1.25 ± 0.15	0.55 ± 0.10	0.30 ± 0.25	0.40 ± 0.20
TRC1206	3.10 ± 0.15	1.60 ± 0.15	0.55 ± 0.10	0.35 ± 0.25	0.50 ± 0.20



TRC Series Consumer-grade Thin Film Chip Resistor Engineering Product Specifications

Document No. P-10-01-179-01

Revision Date 2022/04/28

Page No. 3/8

■ Performance Characteristics

■ Power Derating Curve

The Operating Temperature Range: $-55^{\circ}\text{C} \sim +155^{\circ}\text{C}$.

Power rating is in the case based on continuous full-load at ambient temperature of 70°C . For operation at ambient temperature in excess of 70°C , the load should be derated in accordance with figure of derating Curve.

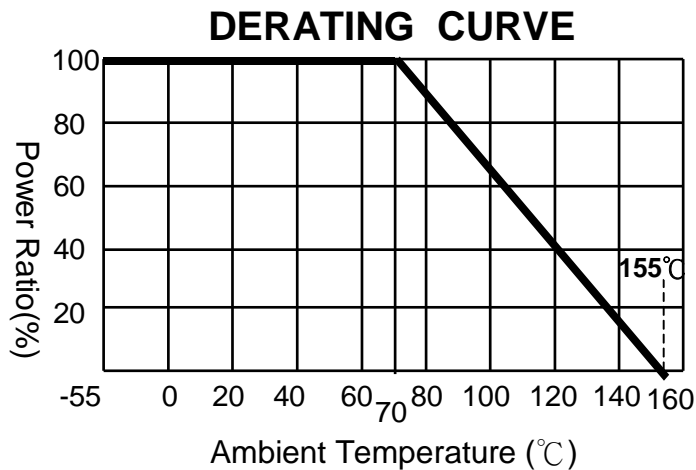

■ Rated Voltage

Resistance Range: $\geq 1\Omega$

Rated Voltage: The resistor shall have a DC continuous working voltage or a RMS AC continuous working voltage at commercial-line frequency and wave form corresponding to the power rating, as determined formula as following:

$$V = \sqrt{P \times R}$$

V = Rated voltage (V)

P = Rated power (W)

R = Nominal resistance (Ω)



**TRC Series Consumer-grade Thin Film
Chip Resistor Engineering Product
Specifications**

Document No. P-10-01-179-01

Revision Date 2022/04/28

Page No. 4/8

■ Reliability Tests and Requirements

Test Item	Test Method	Procedure	Requirements
Temperature Coefficient of Resistance (T.C.R)	JIS-C-5201-1 4.8 IEC-60115-1 4.8	At 25°C /+125°C, 25°C is the reference temperature	Refer to Standard Electrical Specifications
Short Time Overload	JIS-C-5201-1 4.13 IEC-60115-1 4.13	2.5 times RCWV or Max. Overload voltage whichever is less for 5 seconds.	±(0.5%+0.05Ω) No Visual damage
Insulation Resistance	JIS-C-5201-1 4.6 IEC-60115-1 4.6	Apply 100VDC for 1 minute.	≥ 10GΩ
Solderability	JIS-C-5201-1 4.17 IEC-60115-1 4.17	245±5°C for 3 seconds.	>95% Coverage No Visual damage
Resistance to Soldering Heat	JIS-C-5201-1 4.18 IEC-60115-1 4.18	260±5°C for 10 seconds.	±(0.5%+0.05Ω) No Visual damage
Leaching	JIS-C-5201-1 4.18 IEC-60068-2-58 8.2.1	260±5°C for 30 seconds.	>95% Coverage No Visual damage
Rapid Change of Temperature	JIS-C-5201-1 4.19 IEC-60115-1 4.19	-55°C to +155°C, 300 cycles	±(0.5%+0.05Ω) No Visual damage
High Temperature Exposure	JIS-C5201-1 4.25 IEC 60068-2-2	At 155±5°C for 1000 hours.	±(0.5%+0.05Ω)
Resistance to Solvent	JIS-C-5201-1 4.29	The tested resistor be immersed into isopropyl alcohol of 20~25°C for 60 secs. Then the resistor is left in the room for 48 hrs.	±(0.5%+0.05Ω) No Visual damage
Damp Heat with Load	JIS-C-5201-1 4.24 IEC-60115-1 4.24	40±2°C, 90~95% R.H. RCWV or Max. working voltage whichever is less for 1000 hrs with 1.5 hrs "ON" and 0.5 hr "OFF"	±(0.5%+0.05Ω)
Load Life (Endurance)	JIS-C-5201-1 4.25 IEC-60115-1 4.25.1	70±2°C, RCWV or Max. working voltage whichever is less for 1000 hrs with 1.5 hrs "ON" and 0.5 hr "OFF" .	±(0.5%+0.05Ω)
Bending Strength	JIS-C-5201-1 4.33 IEC-60115-1 4.33	Bending once for 5 seconds D : 0402、0603、0805 = 5mm 1206 = 3mm	±(0.5%+0.05Ω) No Visual damage

Recommended Customer Soldering Parameters

Wave solder Temperature condition

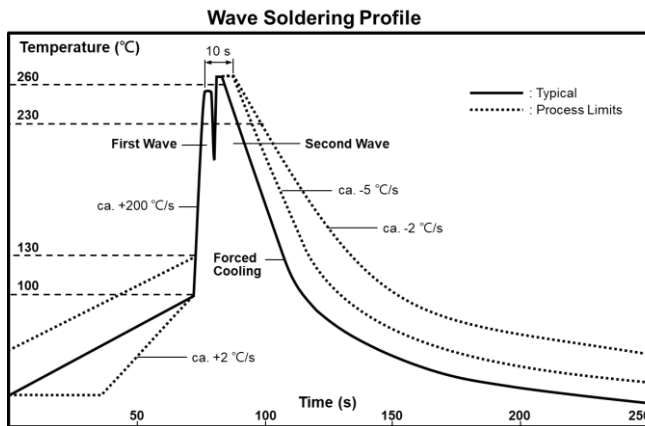

Solder reflow Temperature condition

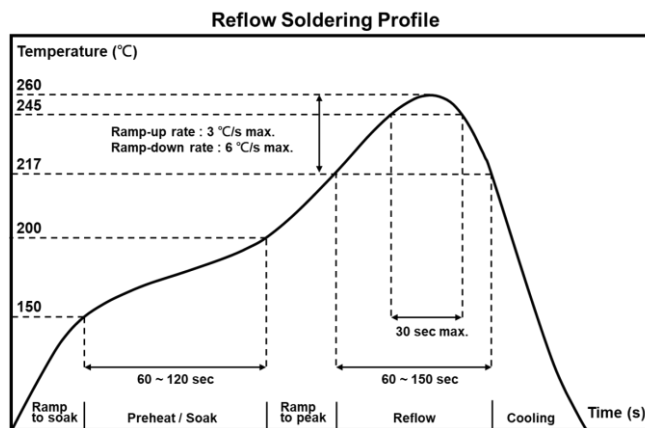

Rework temperature (hot air equipment) : 350°C, 3~5seconds

Recommended reflow methods

IR, vapor phase oven, hot air oven

If reflow temperatures exceed the recommended profile, devices may not meet the performance requirements.

Recommend Land Pattern Design

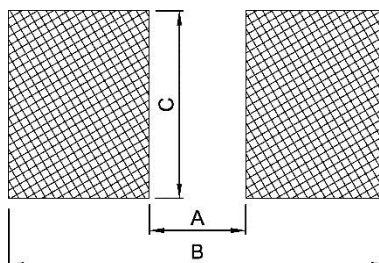

Unit: mm

Type	0402	0603	0805	1206
Item A	0.50	0.80	1.30	2.20
Item B	1.60	2.40	2.90	4.20
Item C	0.70	1.00	1.40	1.70



TRC Series Consumer-grade Thin Film Chip Resistor Engineering Product Specifications

Document No. P-10-01-179-01

Revision Date 2022/04/28

Page No. 6/8

■ Marking



0402: no marking



0603: 3 digits code

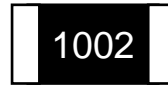

0805~1206: 4 digits code

■ No marking on 0402 type

■ 3 digits code for 0603 type

● Standard E96 Values and 0603 Resistance Codes

R-Value	100	102	105	107	110	113	115	118	121	124	127	130	133	137	140	143	147	150	154	158	162	165	169	174
Code	01	02	03	04	05	06	07	08	09	10	11	12	13	14	15	16	17	18	19	20	21	22	23	24
R-Value	178	182	187	191	196	200	205	210	215	221	226	232	237	243	249	255	261	267	274	280	287	294	301	309
Code	25	26	27	28	29	30	31	32	33	34	35	36	37	38	39	40	41	42	43	44	45	46	47	48
R-Value	316	324	332	340	348	357	365	374	383	392	402	412	422	432	442	453	464	475	487	499	511	523	536	549
Code	49	50	51	52	53	54	55	56	57	58	59	60	61	62	63	64	65	66	67	68	69	70	71	72
R-Value	562	576	590	604	619	634	649	665	681	698	715	732	750	768	787	806	825	845	866	887	909	931	953	976
Code	73	74	75	76	77	78	79	80	81	82	83	84	85	86	87	88	89	90	91	92	93	94	95	96

● E96 Multiplier Code

Code	A	B	C	D	E	F	G	H	X	Y	Z
Multiplier	10 ⁰	10 ¹	10 ²	10 ³	10 ⁴	10 ⁵	10 ⁶	10 ⁷	10 ⁻¹	10 ⁻²	10 ⁻³

1. 0603 3 digits coding formula for E96 values as following:

CODING FORMULA

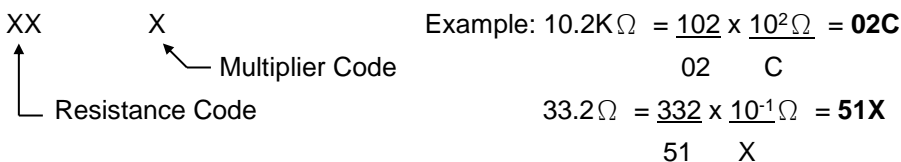

EX.: $7.5\Omega=85Y$; $11\Omega=05X$; $130\Omega=12A$; $2K\Omega=30B$; $10K\Omega=01C$; $150K\Omega=18D$

E24	10	11	12	13	15	16	18	20	22	24	27	30	33	36	39	43	47	51	56	62	68	75	82	91
-----	----	----	----	----	----	----	----	----	----	----	----	----	----	----	----	----	----	----	----	----	----	----	----	----

2. 0603 3 digits for E24 values

Examples:

Resistance	4.7Ω	33Ω	470Ω	5.6KΩ	62KΩ	680KΩ
3 digits code	4R7	330	471	562	623	684

("R"= decimal point)

■ 4 digits code for 0805 ~ 1206 type

First 3 digits are the significant figures, the 4th digit is the multiplier. "R"= decimal point.

Examples:

Resistance	5.6Ω	10Ω	22.6Ω	100Ω	1.1KΩ	10KΩ	332KΩ	1MΩ
4 digits code	5R60	10R0	22R6	1000	1101	1002	3323	1004



**TRC Series Consumer-grade Thin Film
Chip Resistor Engineering Product
Specifications**

Document No. P-10-01-179-01

Revision Date 2022/04/28

Page No. 7/8

■ **Packaging Information**

■ **Reel Dimensions**

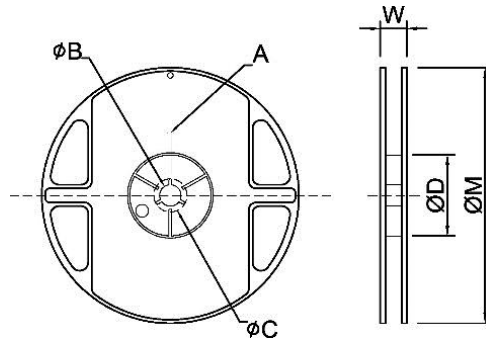

Unit: mm

TYPE	SIZE	SIZE	A	ΦB	ΦC	ΦD	W	ΦM
0402	7"	10K/Reel	2.0±0.5	13.5±1.0	21±1.0	60±1.0	11.5±2.0	178±2.0
0402	13"	40K/50K Reel	2.0±0.5	13.5±1.0	21±1.0	100±1.0	11.5±2.0	330±2.0
0603/0805/1206	7"	5K/Reel	2.0±0.5	13.5±1.0	21±1.0	60±1.0	11.5±2.0	178±2.0
0603/0805/1206	10"	10K/Reel	2.0±0.5	13.5±1.0	21±1.0	100±1.0	11.5±2.0	254±2.0
	13"	20K/Reel	2.0±0.5	13.5±1.0	21±1.0	100±1.0	11.5±2.0	330±2.0

■ **Paper Tape Dimensions**

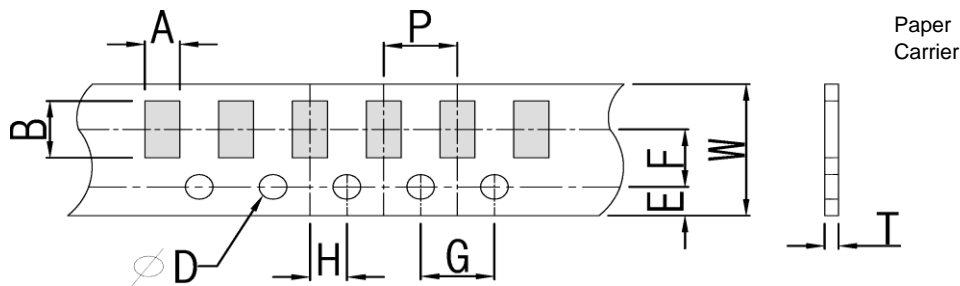

Unit: mm

Type	A	B	W	E	F	G	H	T	ΦD	P
0402	0.70±0.10	1.20±0.10	8.0±0.20	1.75±0.10	3.5±0.05	4.0±0.10	2.0±0.05	0.45±0.10	1.50 ^{+0.10} ₋₀	2.0±0.10
0603	1.05±0.20	1.80±0.20	8.0±0.20	1.75±0.10	3.5±0.05	4.0±0.10	2.0±0.05	0.60±0.10		4.0±0.10
0805	1.55±0.20	2.30±0.20	8.0±0.20	1.75±0.10	3.5±0.05	4.0±0.10	2.0±0.05	0.75±0.10		
1206	1.90±0.20	3.50±0.20	8.0±0.20	1.75±0.10	3.5±0.05	4.0±0.10	2.0±0.05	0.75±0.10		

■ **Front & Back Lead Dimensions**

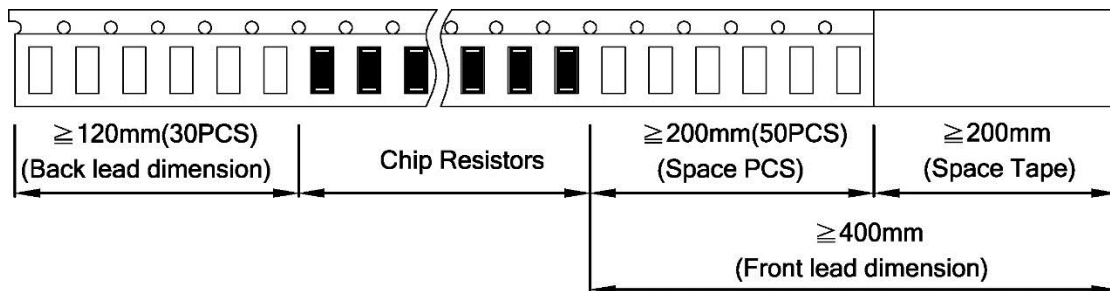

■ **Top Adhesive Peel Off Strength : 10~70g**

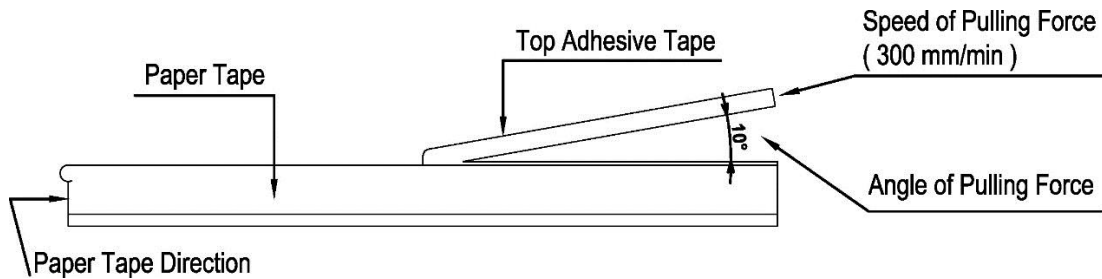

■ **Package**

Inner Box Size	
Reel	Size H(mm)
1	13
2	24
3	36
5	60
10	113

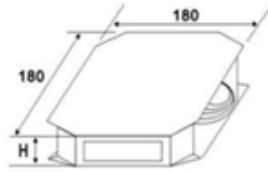

External Box Size			
Contain (Kpcs)	Length (mm)	Width (mm)	Height (mm)
25K	180	180	60
50K	180	180	110
150K	430	200	200
300K	400	400	200

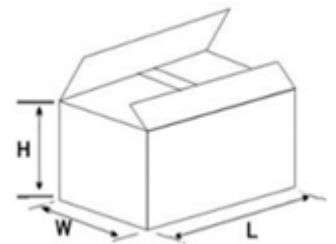

■ **Storage Data :**

Storage time at the environment temp: $25\pm 5^{\circ}\text{C}$ & humidity: $60\pm 20\%$ is valid for one year from the date of delivery.

X-ON Electronics

Largest Supplier of Electrical and Electronic Components

Click to view similar products for [Thick Film Resistors - SMD category](#):

Click to view products by [Ever Ohms manufacturer](#):

Other Similar products are found below :

[CR-05FL7--150R](#) [CR-05FL7--698K](#) [CR-12JP4--680R](#) [CRCW04021K20FKEE](#) [CRCW04028R20JNEE](#) [CRCW06032K10FKEC](#)
[CRCW06036K80FKEE](#) [M55342K03B499DRS6](#) [M55342K06B6E19RWL](#) [M55342K09B5D62RS6](#) [M55342M06B26E7RS3](#) [742C083750JTR](#)
[MCR01MZPF1202](#) [MCR01MZPF1601](#) [MCR01MZPF1800](#) [MCR01MZPF6201](#) [MCR01MZPF9102](#) [MCR01MZPJ121](#) [MCR01MZPJ125](#)
[MCR01MZPJ751](#) [MCR03EZHJ103](#) [MCR03EZPF2004](#) [MCR03EZPJ270](#) [MCR03EZPJ821](#) [MCR10EZPF1102](#) [MCR10EZPF2700](#)
[MCR18EZPJ330](#) [RC1005F1152CS](#) [RC1005F1372CS](#) [RC1005F1912CS](#) [RC1005F2052CS](#) [RC1005F3011CS](#) [RC1005F471CS](#)
[RC1005F4751CS](#) [RC1005F5621CS](#) [RC1005F6041CS](#) [RC1005J121CS](#) [RC1005J122CS](#) [RC1005J154CS](#) [RC1005J180CS](#) [RC1005J181CS](#)
[RC1005J202CS](#) [RC1005J391CS](#) [RC1005J560CS](#) [RC1005J683CS](#) [RC1005J823CS](#) [RC1608F1022CS](#) [RC1608F333CS](#) [RC1608F3651CS](#)
[RC1608F5110CS](#)