

EPH/EPG/EPS SERIES EDGE ACTUATED TYPE

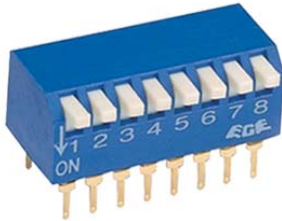

EPH
Housing Height 5mm Only!!



EPG/EPS SPST

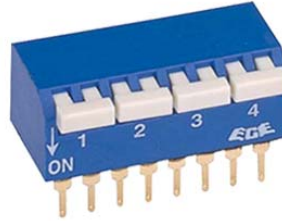

EPG/EPS DPST

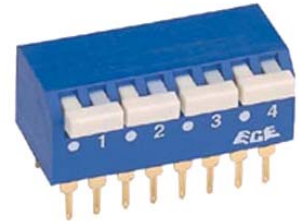

EPG/EPS SPDT

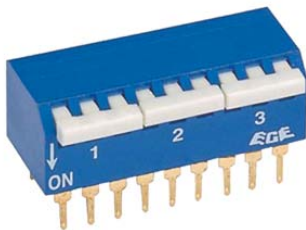

EPG/EPS 3PST

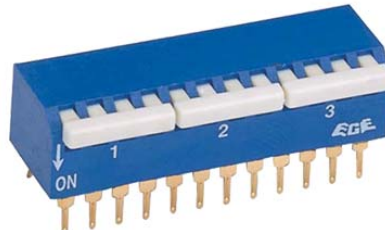

EPG/EPS 4PST

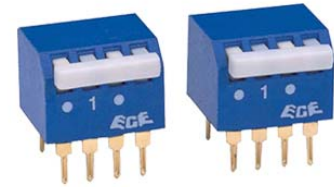

EPG/EPS DPDT

■ FEATURES

- Edge actuated type (Piano Type) easy setting on closely racked PCB.
- Tactile response is performed directly by larger contact pressure to ensure stable contact.
- All plastics are UL 94V-0 grade fire retardant.
- Bottom epoxy sealed to ensure free of flux immersion during wave soldering.
- Contact wiping on make and break.
- Gold or Tin plated contacts to ensure low contact resistance and long operation life.
- Ideal for data processing, communications, remote controls and burglar alarm system use, where manual programming required.
- RoHS Compliant

■ APPLICATIONS

- Numerical setting for computer terminal equipment
- Price setting for vending machines
- Programming for game machines
- Programming for industrial equipment and measuring instruments

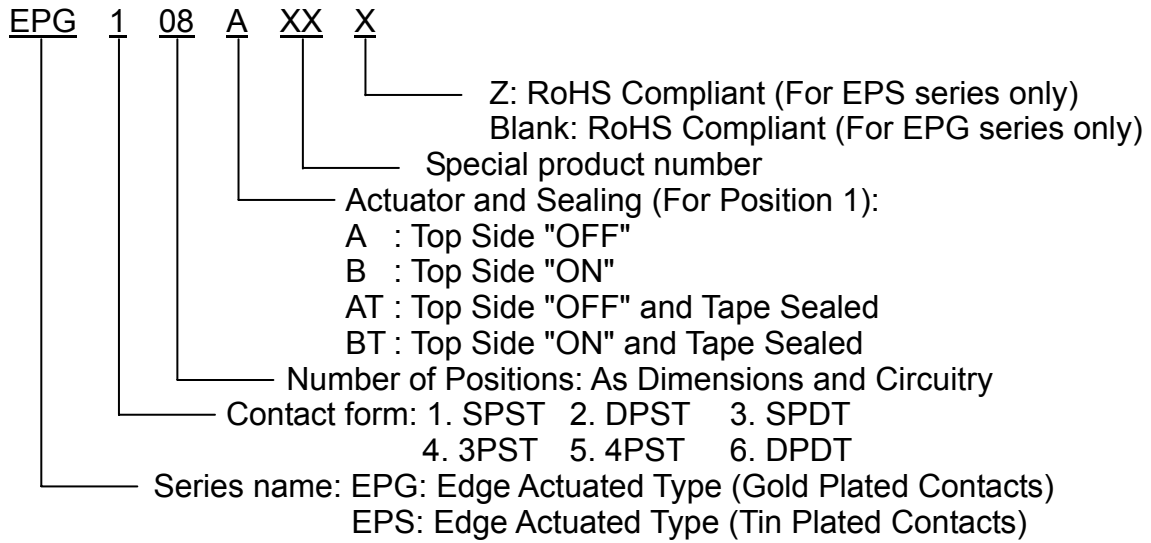

■ CONSTRUCTION

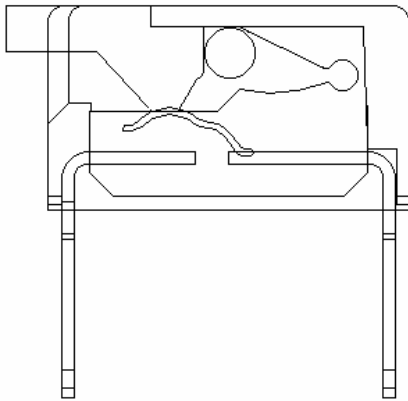

EPH

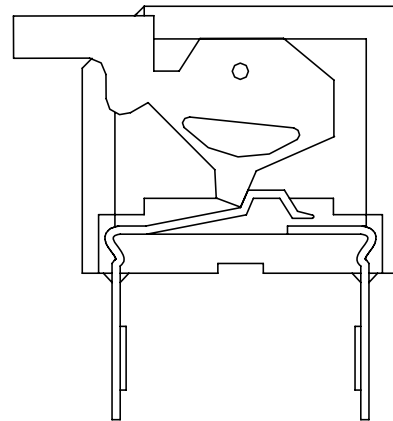

EPG/EPS

■ OPTIONS

1. Special top or side marking available
2. Blue or black body color
3. Normal "ON" (top side "ON") available
4. Tape sealed

EPHxxxLT

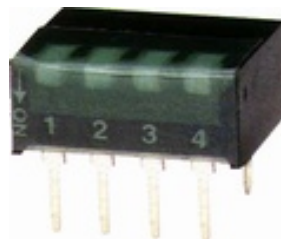

EPGxxxxT

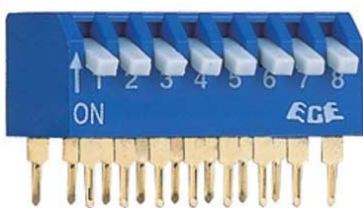
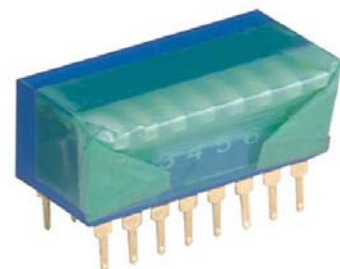

DIMENSIONS AND CIRCUITRY

EPH SERIES

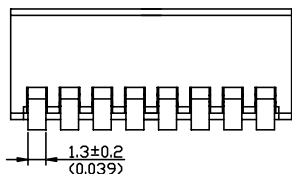

Actuator top side "OFF"

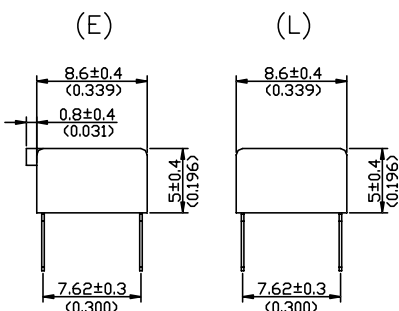
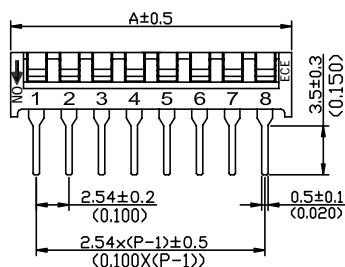

CIRCUIT DIAGRAM

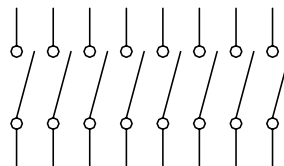

P.C.B. LAYOUT (TOP VIEW)

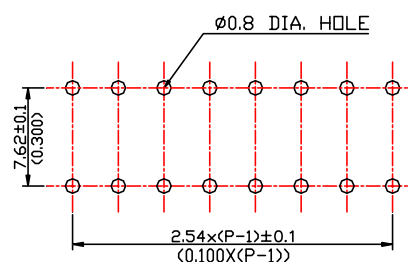

DIMENSION A

UNIT: mm(inch)

POLE	2	3	4	5	6	8	10
A	6.5 (0.256)	9.0 (0.354)	11.6 (0.457)	14.1 (0.555)	16.7 (0.657)	21.7 (0.854)	26.7 (1.050)

EPH SERIES B TYPE

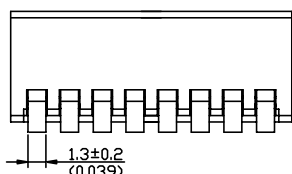

Actuator top side "ON"

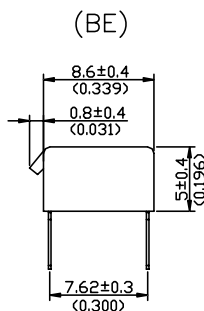
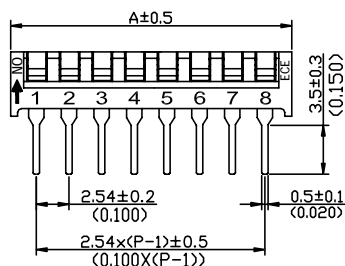

CIRCUIT DIAGRAM

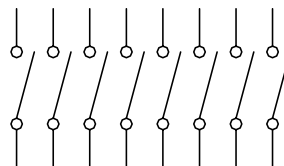

P.C.B. LAYOUT (TOP VIEW)

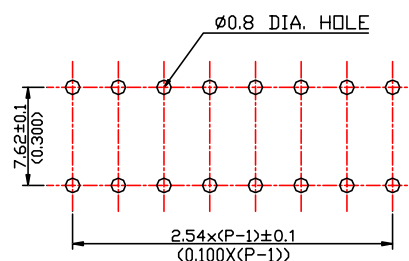

DIMENSION A

UNIT: mm(inch)

POLE	2	3	4	5	6	8	10
A	6.5 (0.256)	9.0 (0.354)	11.6 (0.457)	14.1 (0.555)	16.7 (0.657)	21.7 (0.854)	26.7 (1.050)

EPG/EPS SPST SERIES

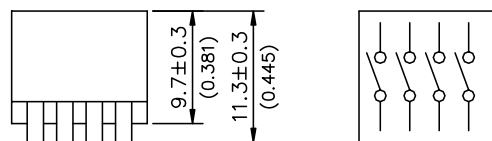

Dimension A UNIT: mm(inch)

Positions	2	3	4	5	6
A	6.7 (0.264)	9.2 (0.362)	11.7 (0.461)	14.2 (0.559)	16.7 (0.657)
Positions	7	8	9	10	12
A	19.2 (0.756)	21.7 (0.854)	24.4 (0.953)	26.7 (1.05)	31.8 (1.25)

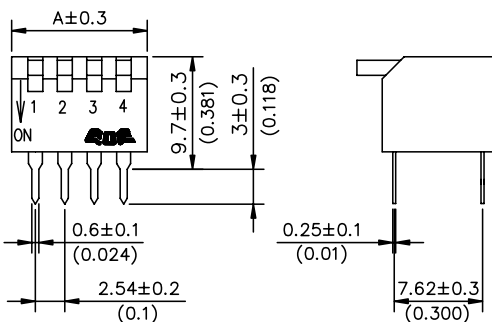

P.C.B. LAYOUT
(TOP VIEW)

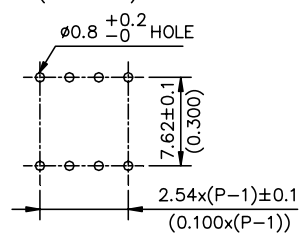

EPG/EPS DPST SERIES

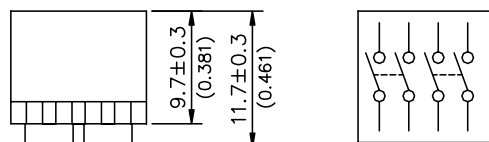

Dimension A UNIT: mm(inch)

Positions	1	2	3
A	6.7 (0.264)	11.7 (0.461)	16.7 (0.657)
Positions	4	5	6
A	21.7 (0.854)	26.7 (1.05)	31.8 (1.25)

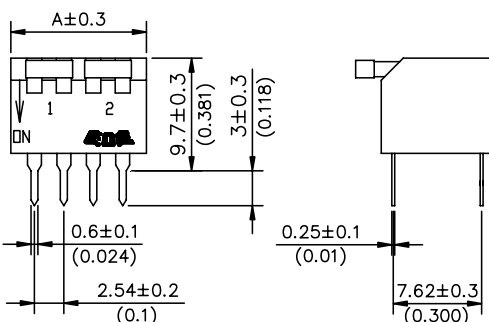

P.C.B. LAYOUT
(TOP VIEW)

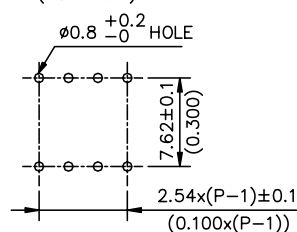

EPG/EPS SPDT SERIES

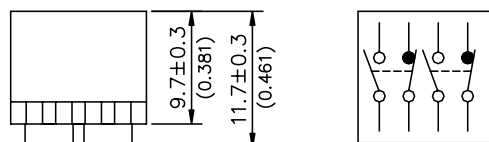

Dimension A UNIT: mm(inch)

Positions	1	2	3
A	6.7 (0.264)	11.7 (0.461)	16.7 (0.657)
Positions	4	5	6
A	21.7 (0.854)	26.7 (1.05)	31.8 (1.25)

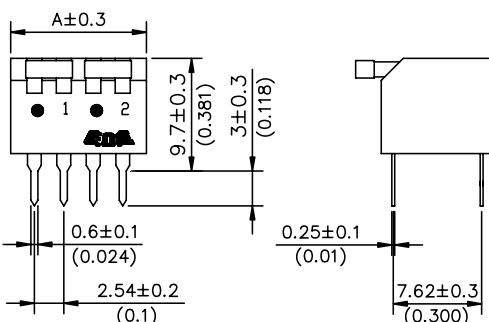

P.C.B. LAYOUT
(TOP VIEW)

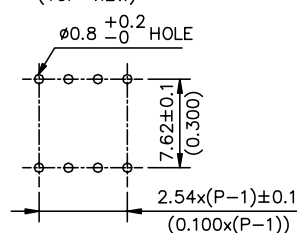

EPG/EPS 3PST SERIES

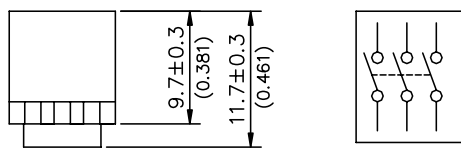

Dimension A UNIT: mm(inch)

Positions	1	2	3	4
A	9.2 (0.362)	16.7 (0.657)	24.2 (0.953)	31.8 (1.25)

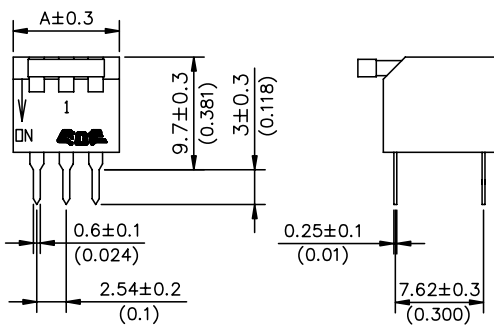

P.C.B. LAYOUT
(TOP VIEW)

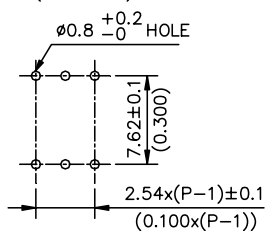

EPG/EPS 4PST SERIES

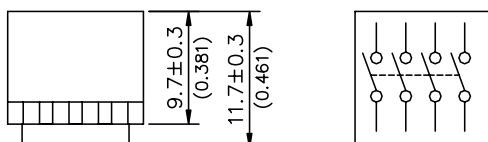

Dimension A UNIT: mm(inch)

Positions	1	2	3
A	11.7 (0.461)	21.7 (0.854)	31.8 (1.25)

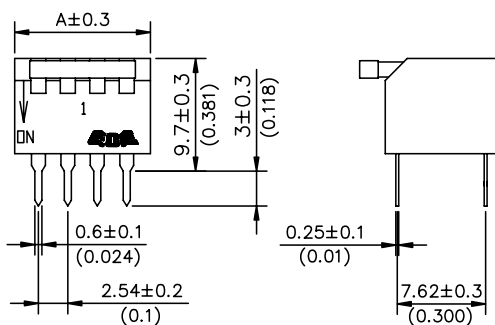

P.C.B. LAYOUT
(TOP VIEW)

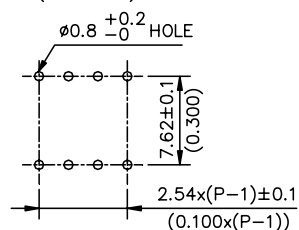

EPG/EPS DPDT SERIES

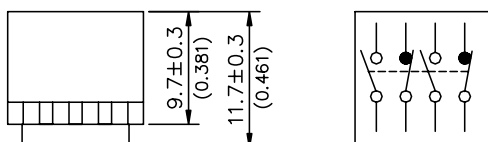

Dimension A UNIT: mm(inch)

Positions	1	2	3
A	11.7 (0.461)	21.7 (0.854)	31.8 (1.25)

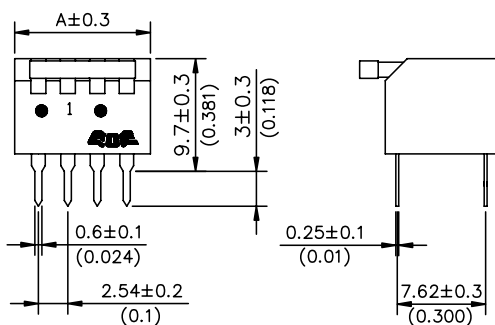

P.C.B. LAYOUT
(TOP VIEW)

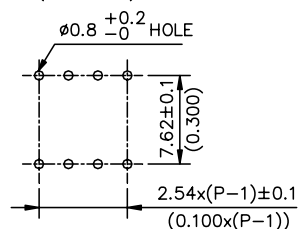

X-ON Electronics

Largest Supplier of Electrical and Electronic Components

Click to view similar products for [DIP Switches/SIP Switches](#) category:

Click to view products by [Excel Cell Electronic\(ECE\)](#) manufacturer:

Other Similar products are found below :

[79B10T](#) [8136-475G4T](#) [G7G-1A2-CB-DC12](#) [DRR60016](#) [DRS4016](#) [1825444-1](#) [200183](#) [206002](#) [219-6LPSTRF](#) [25.350.0653.0](#)
[SDA10H1BDA](#) [97R06ST](#) [A2C-2A5](#) [1825058-4](#) [1825444-7](#) [ADE08SA04](#) [ADE12S04](#) [192960010](#) [206005RAS](#) [206007](#) [2-1825058-8](#)
[25.352.0353.0](#) [CXDRIVEV2X](#) [LA2-002-DC24](#) [DSR02T](#) [E2FMX2D1M1TGJ03M](#) [NDI10H](#) [219-9MSTP](#) [EPM02FV](#) [206010RAST](#) [219-](#)
[5LPSTJRF](#) [76SB05](#) [TD06H0SK1](#) [Z7.255.9027.0](#) [1-1825058-3](#) [1825428-4](#) [219-10LPSTF](#) [E3ZG6111D03M](#) [G4D212PUSTV2DC5](#)
[EPG301BT06](#) [1-1825058-6](#) [E3TSL23M5J03M](#) [Y5795](#) [7R0060](#) [HARW0001](#) [ADE07S04](#) [432220096](#) [206005](#) [206006](#) [206010](#)