



Switch

EPH/EPG/EPS SERIES EDGE ACTUATED TYPE



EPH
Housing Height 5mm Only!!

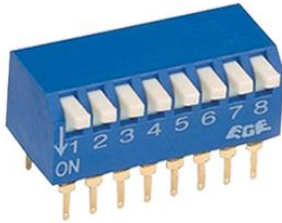

EPG/EPS SPST

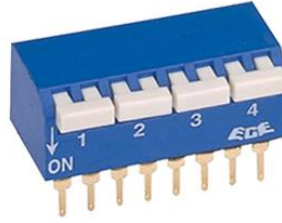

EPG/EPS DPST

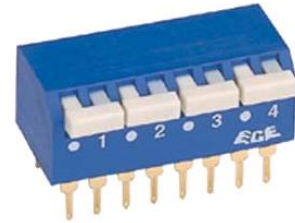

EPG/EPS SPDT

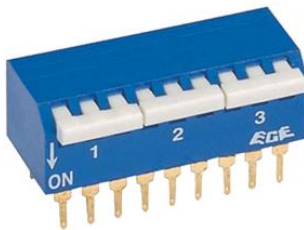

EPG/EPS 3PST

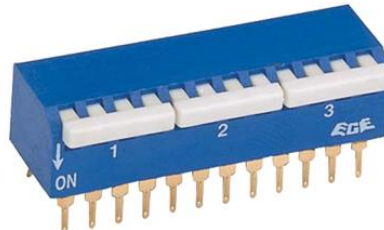

EPG/EPS 4PST



EPG/EPS DPDT

■ FEATURES

- Edge actuated type (Piano Type) easy setting on closely racked PCB.
- Tactile response is performed directly by larger contact pressure to ensure stable contact.
- All plastics are UL 94V-0 grade fire retardant.
- Bottom epoxy sealed to ensure free of flux immersion during wave soldering.
- Contact wiping on make and break.
- Gold, Silver, or Tin plated contacts to ensure low contact resistance and long operation life.
- Ideal for data processing, communications, remote controls and burglar alarm system use, where manual programming required.
- RoHS Compliant

■ APPLICATIONS

- Numerical setting for computer terminal equipment
- Price setting for vending machines
- Programming for game machines
- Programming for industrial equipment and measuring instruments



■ SPECIFICATIONS

1.ELECTRICAL

● Contact rating	
switching	25mA, 24VDC
non-switching	100mA
● Contact resistance (After life test)	100mΩ Max. (300mΩ Max. for Tin plated type)
● Insulation resistance	1000MΩ Min. at 100VDC
● Dielectric strength	500VDC Min. for 60 seconds
● Leakage Current	2mA Max.
● Capacitance between adjacent switches 5pF Max.	

2.MECHANICAL AND ENVIRONMENTAL

● Temperature rating	
operating	-25°C to +70°C
storage	-40°C to +85°C
● Operation force	800g Max. (SPST only)
● Mechanical life	1000 operations (EPH) 2000 operations (EPG/EPS)
● Humidity	95% RH, 40°C for 96 Hrs.
● Vibration	10Hz-55Hz-10Hz for 6 Hrs.
● Solderability	After flux 230±5°C for 5±0.5 seconds, 95% coverage
● Soldering heat	After 260±5°C for 5±1 sec. shall have no deterioration

■ PART NUMBERING SYSTEM

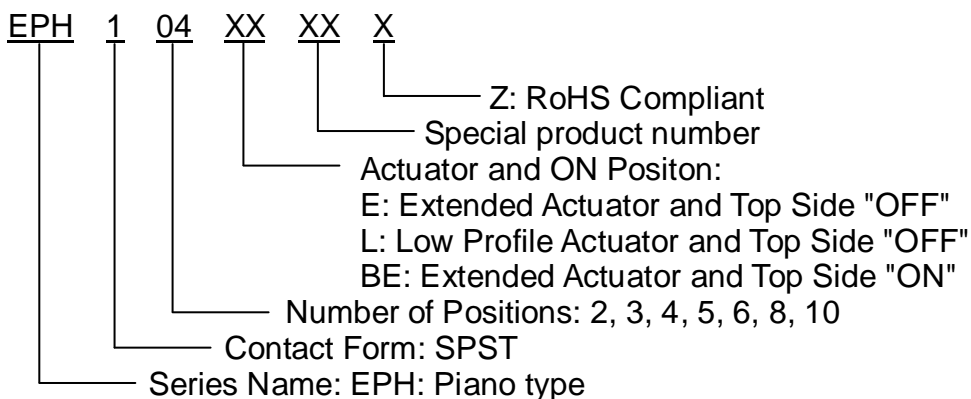

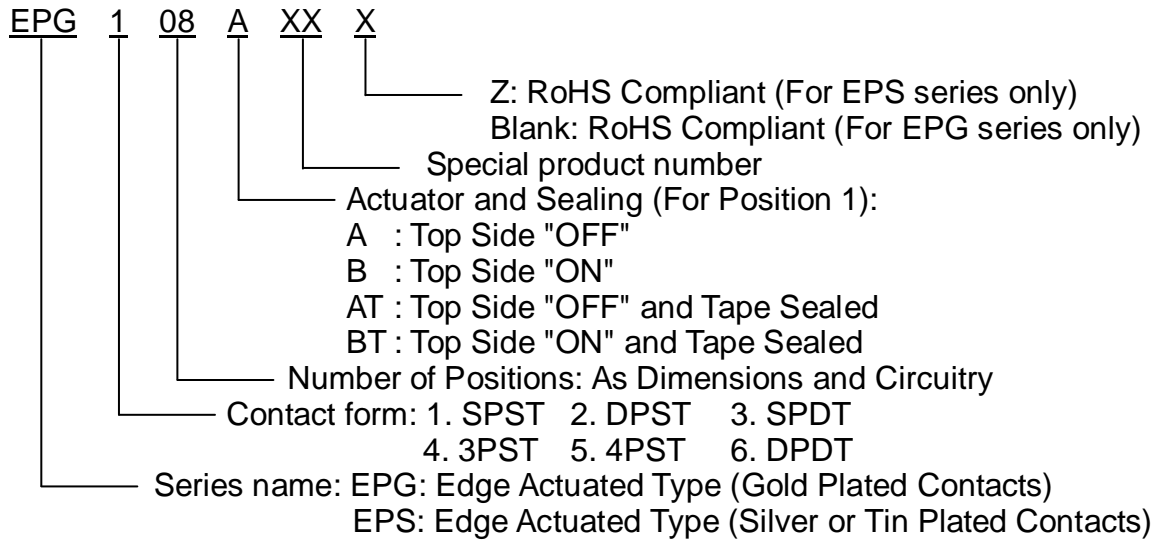

■ CONSTRUCTION

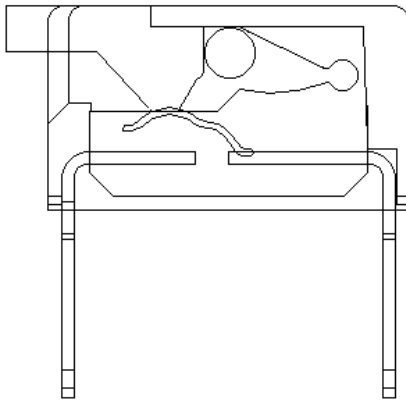

EPH

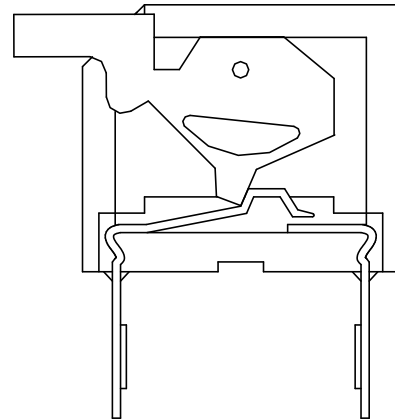

EPG/EPS

■ OPTIONS

1. Special top or side marking available
2. Blue or black body color
3. Normal "ON" (top side "ON") available
4. Tape sealed

EPHxxxLT



EPGxxxxT

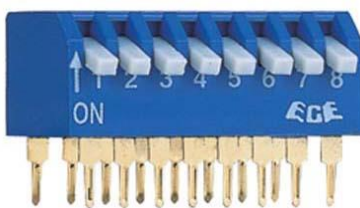
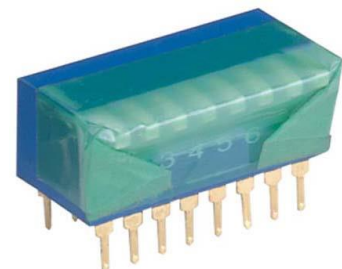

DIMENSIONS AND CIRCUITRY

EPH SERIES

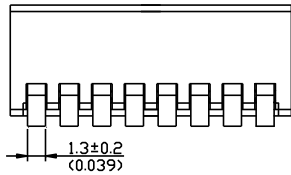

Actuator top side "OFF"

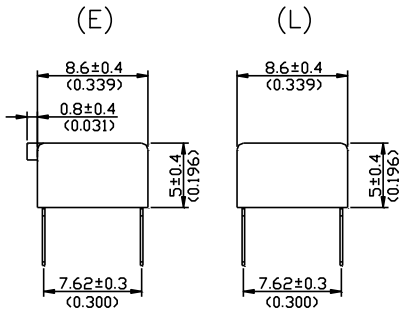
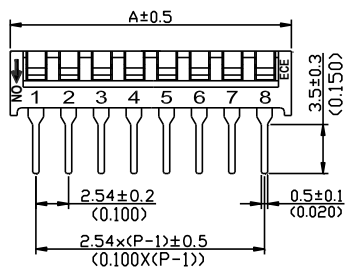

CIRCUIT DIAGRAM

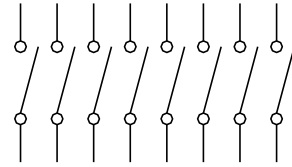

P.C.B. LAYOUT (TOP VIEW)

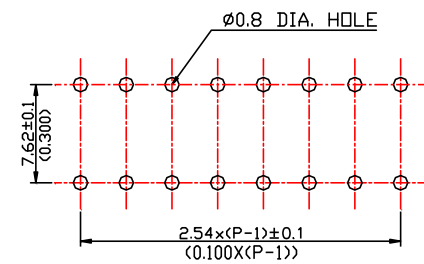

DIMENSION A

UNIT: mm (inch)

POLE	2	3	4	5	6	8	10
A	6.5 (0.256)	9.0 (0.354)	11.6 (0.457)	14.1 (0.555)	16.7 (0.657)	21.7 (0.854)	26.7 (1.050)

EPH SERIES B TYPE

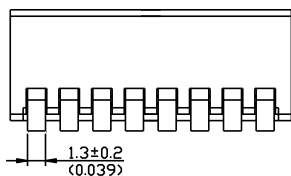

Actuator top side "ON"

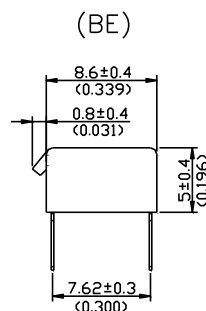
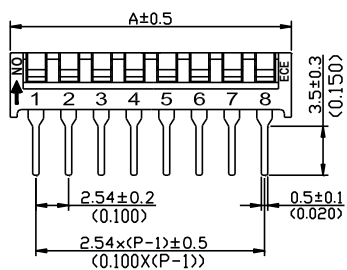

CIRCUIT DIAGRAM

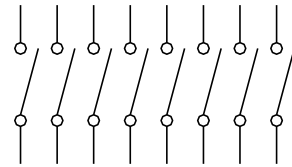

P.C.B. LAYOUT (TOP VIEW)

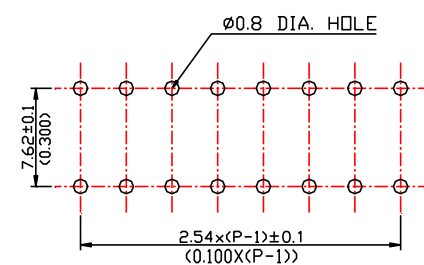

DIMENSION A

UNIT: mm (inch)

POLE	2	3	4	5	6	8	10
A	6.5 (0.256)	9.0 (0.354)	11.6 (0.457)	14.1 (0.555)	16.7 (0.657)	21.7 (0.854)	26.7 (1.050)

EPG/EPS SPST SERIES

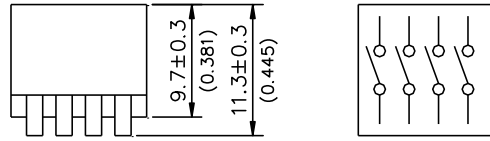

Dimension A UNIT: mm(inch)

Positions	2	3	4	5	6
A	6.7 (0.264)	9.2 (0.362)	11.7 (0.461)	14.2 (0.559)	16.7 (0.657)
Positions	7	8	9	10	12
A	19.2 (0.756)	21.7 (0.854)	24.4 (0.953)	26.7 (1.05)	31.8 (1.25)

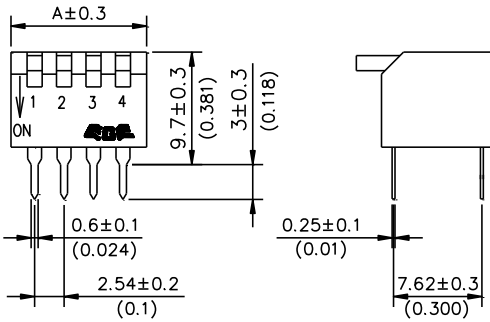

P.C.B. LAYOUT (TOP VIEW)

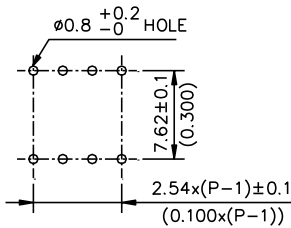

EPG/EPS DPST SERIES

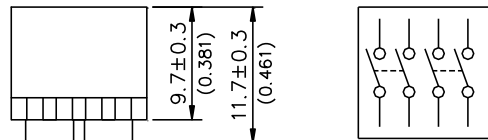

Dimension A UNIT: mm(inch)

Positions	1	2	3
A	6.7 (0.264)	11.7 (0.461)	16.7 (0.657)
Positions	4	5	6
A	21.7 (0.854)	26.7 (1.05)	31.8 (1.25)

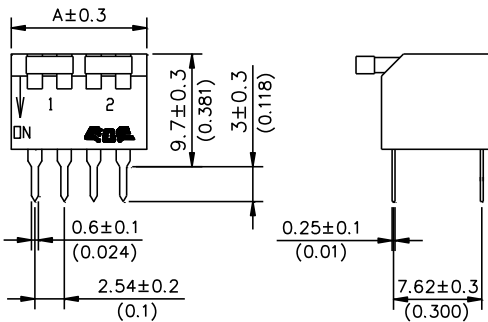

P.C.B. LAYOUT (TOP VIEW)

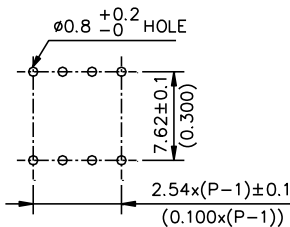

EPG/EPS SPDT SERIES

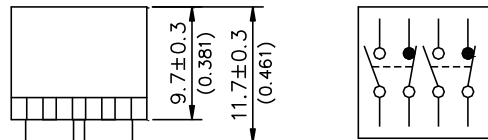

Dimension A UNIT: mm(inch)

Positions	1	2	3
A	6.7 (0.264)	11.7 (0.461)	16.7 (0.657)
Positions	4	5	6
A	21.7 (0.854)	26.7 (1.05)	31.8 (1.25)

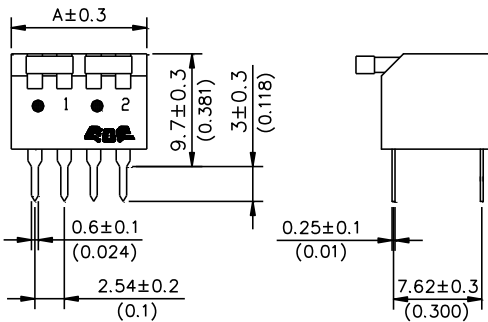

P.C.B. LAYOUT (TOP VIEW)

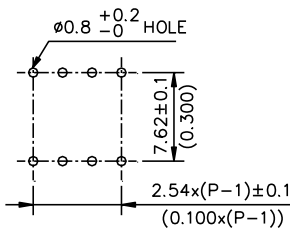

EPG/EPS 3PST SERIES

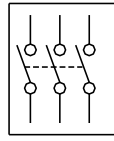
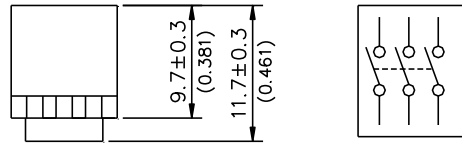

Dimension A UNIT: mm(inch)

Positions	1	2	3	4
A	9.2 (0.362)	16.7 (0.657)	24.2 (0.953)	31.8 (1.25)

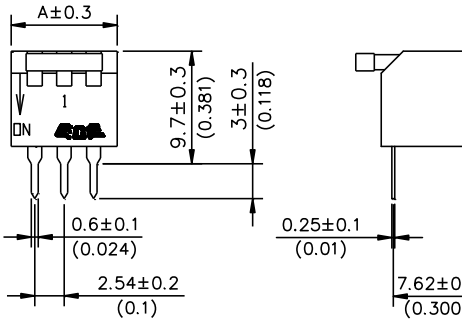

P.C.B. LAYOUT
(TOP VIEW)

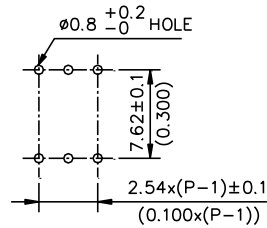

EPG/EPS 4PST SERIES

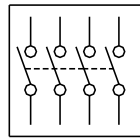
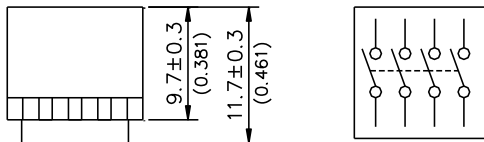

Dimension A UNIT: mm(inch)

Positions	1	2	3
A	11.7 (0.461)	21.7 (0.854)	31.8 (1.25)

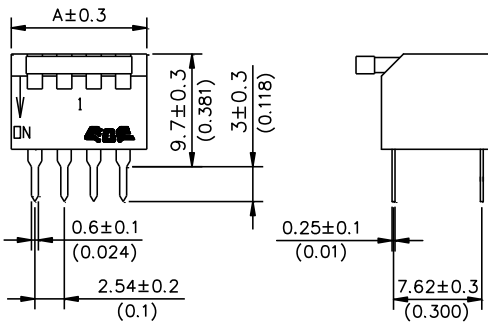

P.C.B. LAYOUT
(TOP VIEW)

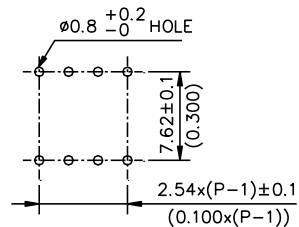

EPG/EPS DPDT SERIES

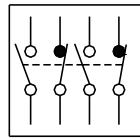
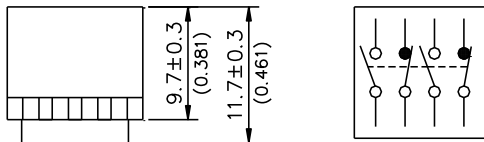

Dimension A UNIT: mm(inch)

Positions	1	2	3
A	11.7 (0.461)	21.7 (0.854)	31.8 (1.25)

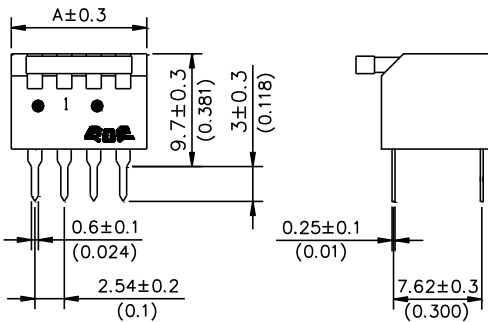

P.C.B. LAYOUT
(TOP VIEW)

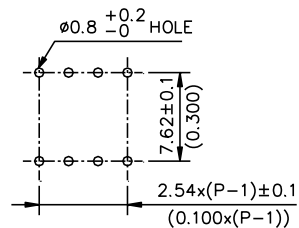

X-ON Electronics

Largest Supplier of Electrical and Electronic Components

Click to view similar products for [DIP Switches/SIP Switches](#) category:

Click to view products by [Excel Cell Electronic\(ECE\)](#) manufacturer:

Other Similar products are found below :

[79B10T](#) [8136-475G4T](#) [G7G-1A2-CB-DC12](#) [H7CZL8AC100240](#) [DRR60016](#) [DRS4016](#) [1825008-1](#) [1825444-1](#) [200183](#) [206002](#) [219-6LPSTRF](#) [25.350.0653.0](#) [SBS 5004 TG](#) [SDA10H1BDA](#) [97R06ST](#) [A2C-2A5](#) [1825444-7](#) [ADE08SA04](#) [ADE12S04](#) [192960010](#) [206005RAS](#) [206007](#) [2-1825058-8](#) [25.330.0653.1](#) [25.352.0353.0](#) [CXDRIVEV2X](#) [IKN0600000](#) [IKN0800000](#) [LA2-002-DC24](#) [DRD10CRAE04](#) [DSR02T](#) [DSS 208 N](#) [E2FMX2D1M1TGJ03M](#) [NDI10H](#) [219-9MSTP](#) [EPM02FV](#) [206010RAST](#) [NDS08V](#) [76SB05](#) [TD06H0SK1](#) [Z7.255.9027.0](#) [1-1825058-3](#) [1825428-4](#) [219-10LPSTF](#) [E3ZG6111D03M](#) [G4D212PUSTV2DC5](#) [EPG301BT06](#) [219-7LPSTRF](#) [1-1825058-6](#) [E3TSL23M5J03M](#)