 EXCEL CELL ELECTRONIC CO., LTD.	NO.	A31122			
	SPECIFICATION		Edition	5	Page

ETR GU RELAY

1. FEATURES:

- 1-1. Single contact Form (SPST) series Relay offers switching capacity 30A in small size.
- 1-2. Dust cover, sealed & unclosed cover types are available.
- 1-3. UL Class F insulation available.
- 1-4. Halogen Free series available.
- 1-5. Comply with RoHS and REACH regulations.
- 1-6. Safety standard & File unnumber: UL&C-UL E141060

2. SPECIFICATION:

2-1. Contact Specification:

- 2-1-1. Contact Resistance: Maximum 100mΩ at initial value.
 Test Current: 1A, Open Circuit Test Voltage: 6VDC.
 By using Voltage Drop Method.
- 2-1-2. Contact Capacity:
 - GU(D): NC: 20 Amps at 240VAC Cosφ=1.
 20 Amps at 30VDC L/R=0.
 - NO: 30 Amps at 240VAC Cosφ=1.
 30 Amps at 30VDC L/R=0.
 TV-8 Amp at 120VAC
 - GU(DM): 30 Amps at 240VAC Cosφ=1.
 30 Amps at 30VDC L/R=0.
 TV-8 Amp at 120VAC
 - GU(DB): 10 Amps at 240VAC Cosφ=1.
 10 Amps at 240VAC Cosφ=1.
- 2-1-3. Operate Time: 15 mSec. Max.
- 2-1-4. Release Time: 10 mSec. Max.

2-2. Coil Specification at 20°C:

Coil Sensitivity	Nominal Voltage (VDC)	Nominal Current (mA)	Coil Resistance (Ω±10%)	Power Consumption (W)	Pull-In Voltage (VDC)	Drop-Out Voltage (VDC)	Maximum Allowable Voltage
GU-D	5	185	27	Abt. 0.93	80% Maximum	5% Minimum	150% but for short time carrying current
	6	150	40				
	9	93	97				
	12	77	155				
	15	59	255				
	18	47	380				
	24	36	660				
	36	25.8	1,390				
	48	19.4	2,480				
	110	8.5	13,000				

 EXCEL CELL ELECTRONIC CO., LTD.	NO.	A31122		
	SPECIFICATION	Edition	5	Page

3. Electrical Characteristics:

3-1. Life Expectancy:

100,000 operations Minimum at

GU (D)	NC: 20 Amps at 240VAC Cosφ=1. 10 Amps at 30VDC L/R=0. NO: 30 Amps at 240VAC Cosφ=1. 20 Amps at 30VDC L/R=0.
GU (DM)	30 Amps at 240VAC Cosφ=1. 30 Amps at 30VDC L/R=0.
GU (DB)	10 Amps at 240VAC Cosφ=1. 10 Amps at 30VDC L/R=0.

25,000 operations Minimum at TV-8 120VAC.

Rated Voltage is applied.

3-1-2. Mechanical Life:

10,000,000 operations Minimum at No Load condition.

Rated Voltage is applied.

3-1-3. Maximum Operating Frequency:

Electrical: 6 operations/minute.

Mechanical: 300 operations/minute.

3-2. Dielectric Strength:

3-2-1. Between Contacts:

1,500VAC at Test Frequency 50/60 Hz,
Leakage Current: 5mA for 1 minute.

3-2-2. Between Coil & Contact:

1,500VAC at Test Frequency 50/60 Hz,
Leakage Current: 5mA for 1 minute.

3-3. Insulation Resistance:

≥ 100 MΩ Minimum.

A Voltage of 500VDC should be applied after which measurement shall be made.

3-4. Vibration

3-4-1. Endurance I:

The Coil shall be maintained under not energized condition, double amplitude 1.5 mm, the entire frequency range changes from 10 to 55 Hz then returns to 10 Hz shall be made in 1 minute. This motion shall be applied for a period of 2 hours in each of 3 mutually perpendicular axis (a total of 6 hours) There should not be any deformations in construction and in appearance, while the Electrical Specifications should be fulfilled after the test.

 EXCEL CELL ELECTRONIC CO., LTD.	NO.	A31122		
	SPECIFICATION	Edition	5	Page

3-4-2. Endurance II
(Error Operation):

The Coil shall be maintained under energized condition, double amplitude 1.5 mm, the entire frequency range changes from 10 to 55 Hz then returns to 10 Hz shall be made in 1 minute. This motion shall be applied for a period of 5 minutes in 3 mutually perpendicular axis. Malfunction is not allowed during the test (contact breaking time should be less than 1 millisecond) In addition, there should not be any deformations in construction and in appearance while the Electrical Specifications should be fulfilled after the test.

3-5. Shock:

3-5-1. Endurance I:

Peak Acceleration: 1000m/s²
The Coil shall be maintained under not energized condition, 5 successive shocks shall be applied in 3 mutually perpendicular axis. There should not be any deformations in construction and in appearance while the Electrical Specifications should be fulfilled after the test.

3-5-2. Endurance II
(Error Operation):

Peak Acceleration: 50m/s²
The Coil should be maintained under energized condition, 2 successive shocks shall be applied in 3 mutually perpendicular axis. Malfunction is not allowed during the test (contact breaking time should be less than 1 millisecond) In addition, there should not be any deformations in construction and in appearance while the Electrical Specifications should be fulfilled after the test.

4. Environmental Characteristics:

4-1. Temperature Range:

4-1-1. Operating Temperature
Range:

-25 to + 55°C
Operating temperature range is the range of ambient temperature of which the Relay can be operated continuously within operative voltage range of coil (no condensation of water drops under low temperature condition)

4-1-2. Storage Temperature
Range:

-25 to + 55°C.
Storage temperature range is the range of ambient temperature of which the Relay can be stored without damages (no condensation of water drops under low temperature condition). Conditions are as specified elsewhere in these specifications.

 EXCEL CELL ELECTRONIC CO., LTD.	NO.	A31122		
	SPECIFICATION	Edition	5	Page

4-2. Humidity Range: 45~85% RH.

4-3. Coil Temperature Rise 60°C Max.

4-4. Cold Resistance:

4-4-1. Cold Resistance in Use: Relay should be kept in temperature chamber at $-25 \pm 2^{\circ}\text{C}$ for two hours that no current or voltage shall be supplied to Relay. Such condition shall be maintained while the rated voltage is supplied to Relay, then the Relay shall operate normally. (No condensation of water drops under low temperature condition)

4-4-2. Storage Cold Resistance: Relay should be kept in temperature chamber at $-25 \pm 2^{\circ}\text{C}$ for 72 hours. Then the Relays shall be maintained at standard atmospheric condition for 1 to 2 hours after which measurement shall be made. Construction, Relay operation, Insulation Resistance and Dielectric Strength shall satisfy the specification requirements. (No condensation of water drops under low temperature condition)

4-5. Heat Resistance:

4-5-1. Heat Resistance in Use: Relay should be kept in temperature chamber at $55 \pm 2^{\circ}\text{C}$ for two hours that rated Voltage should be supplied to Coil while rated Current should be supplied to Contacts. Such condition shall be maintained while the rated voltage is supplied to Relay, then Relay shall operate normally.

4-5-2. Storage Heat Resistance: Relay should be kept in temperature chamber at $55 \pm 2^{\circ}\text{C}$ for 16 hours. Then the Relays shall be maintained at standard atmospheric condition for 1 to 2 hours after which measurement shall be made. Construction, Relay operation, Insulation Resistance and Dielectric Strength shall satisfy the specification requirements.

4-6. Moisture Resistance: Relay should be kept in temperature chamber at $40 \pm 2^{\circ}\text{C}$ (90~95% RH) for 48 hours. Then the Relays shall be maintained at standard atmospheric condition for 1 to 2 hours after which measurement shall be made. Construction, Relay operation, Insulation Resistance, Dielectric Strength shall satisfy the specification requirements.

5. Terminal Characteristics:

5-1. Soldering Dip Test: The front 3 mm of Terminal should be immersed for 3 ± 0.5 seconds at $245 \pm 5^{\circ}\text{C}$. Soldered area must be minimum 90% of the soldering surface.

 EXCEL CELL ELECTRONIC CO., LTD.	NO.	A31122		
	SPECIFICATION	Edition	5	Page

5-2. Soldering Heat Resistance: When the Terminal are immersed into soldering bath at 260 °C for 3 seconds, the Relay shall satisfy all electrical and mechanical specifications and must not have excessive change in outside appearance.

6. PART NUMBERING SYSTE

ETR - GU - SS - 1 12 D M CF - 5 Z

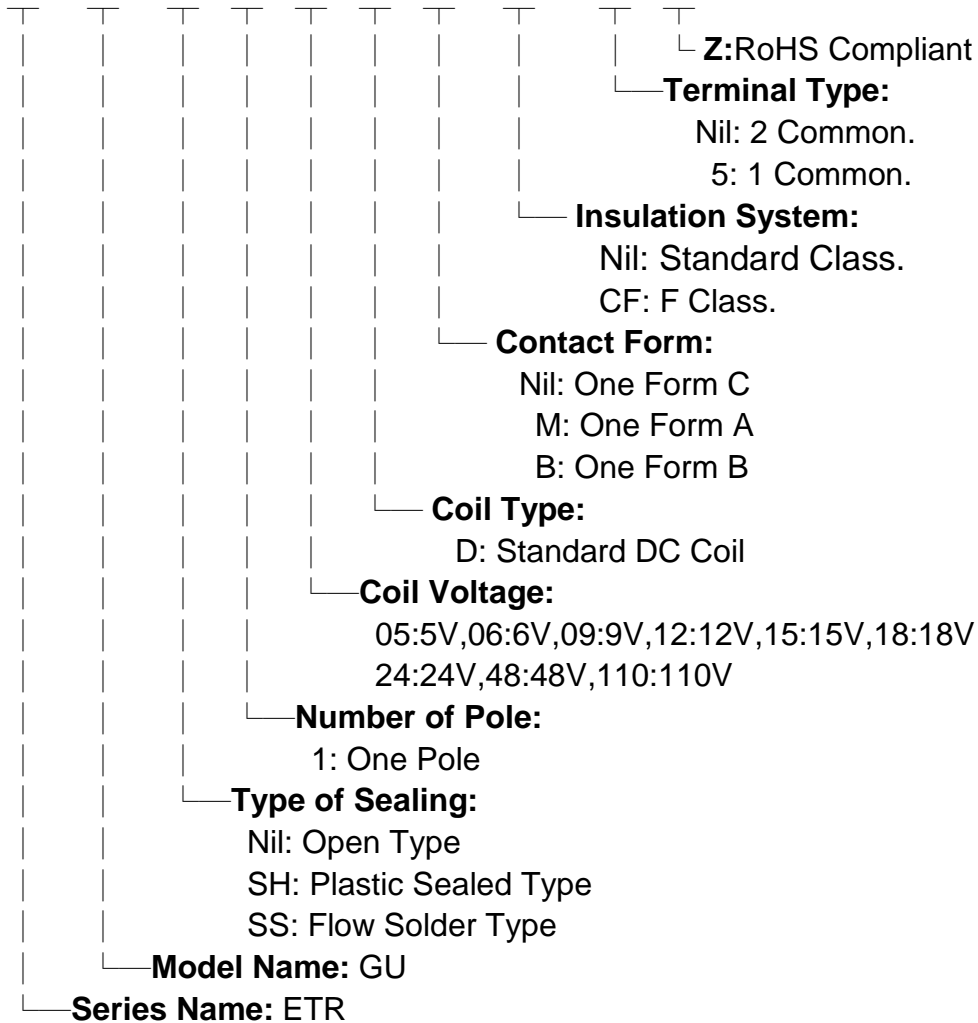

*Marking without: "ETR" & "Z" .

Dimension

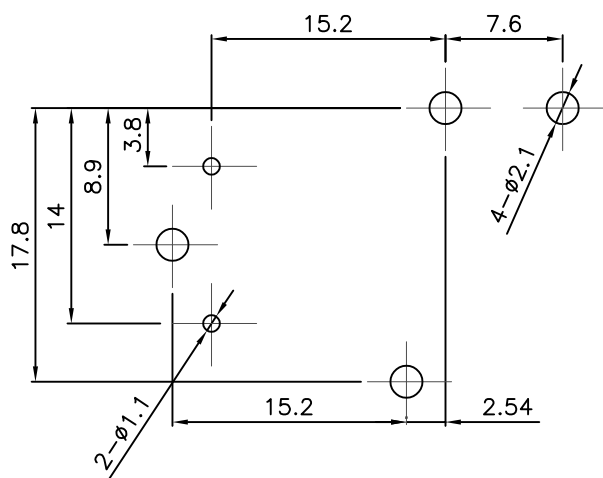
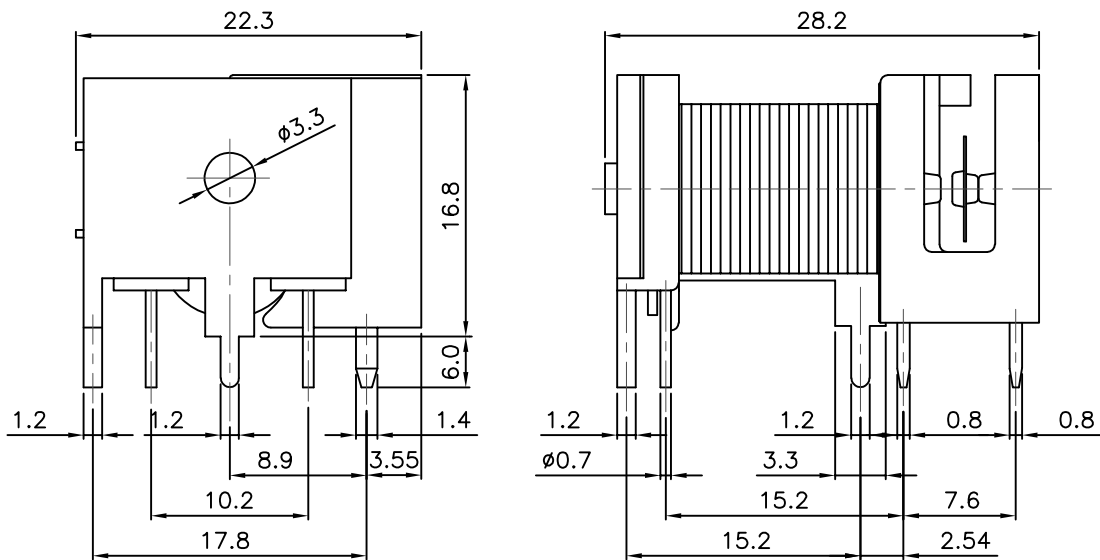

P.C.B LAYOUT

2 Common terminals:

1 Common terminals:

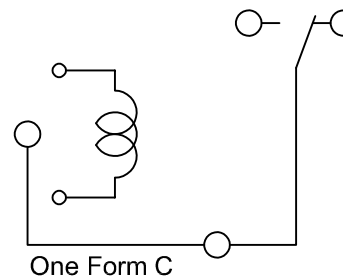

One Form C

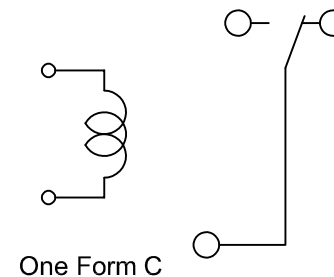

One Form C

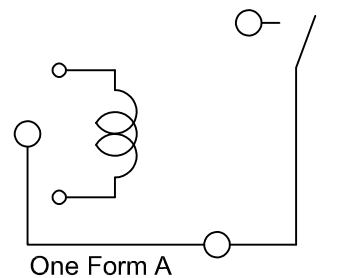

One Form A

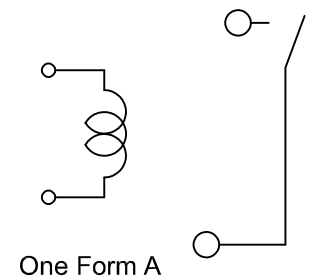

One Form A

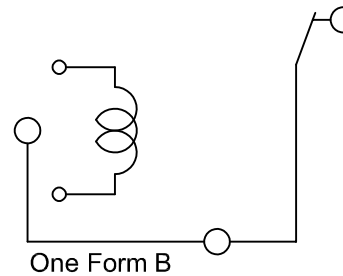

One Form B

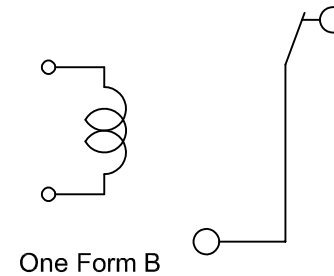

One Form B

BOTTOM VIEW

				NORMAL TOLERANCE		PART NUMBER		UNIT	MM(INCH)	PART NAME	ETR												
				RANGE	TOLERANCE	MATERIAL		SCALE	2 : 1	TYPE	GU(OPEN)												
				0 - 1	±0.1	CHECK	CCY	QUANTITY	-----	FILE NAME	GU-OPEN.DWG												
				1 - 4	±0.3							DESIGN	WINNIE	DRAWN	WINNIE	EDITION	A						
				4 - 16	±0.5													PROCESSING	-----	SURFACE TREATMENT	-----		
				16 - 63	±0.8																	PROJECTION	
				63 - 250	±1.0																		
NO.	DETAILS	ALTERED BY	DATE																				

X-ON Electronics

Largest Supplier of Electrical and Electronic Components

Click to view similar products for [General Purpose Relays](#) category:

Click to view products by [Excel Cell Electronic\(ECE\)](#) manufacturer:

Other Similar products are found below :

[PCN-105D3MH,000](#) [59641F200](#) [5JO-1000CD-SIL](#) [5X827E](#) [5X837F](#) [5X840F](#) [5X842F](#) [5X848E](#) [LY2N-AC120](#) [LY2-US-AC120](#) [M115C60](#)
[M115N010](#) [M115N0150](#) [603-12D](#) [60HE1-5DC](#) [60HE2S-12DC](#) [61211T0B4](#) [61212T400](#) [61222Q400](#) [61243B600](#) [61243C500](#) [61243Q400](#)
[61311BOA2](#) [61311BOA6](#) [61311BOA8](#) [61311C0A2](#) [61311COA1](#) [61311COA6](#) [61311F0A2](#) [61311QOA1](#) [61311QOA4](#) [61311T0D6](#)
[61311TOA6](#) [61311TOA7](#) [61311TOB3](#) [61311TOB4](#) [61311U0A6](#) [61312Q600](#) [61312T400](#) [61312T600](#) [61313U200](#) [61313U400](#) [61322T400](#)
[61332C400](#) [61343C200](#) [61343C600](#) [61343Q200](#) [61343T100](#) [61343T200](#) [61343T400](#)