

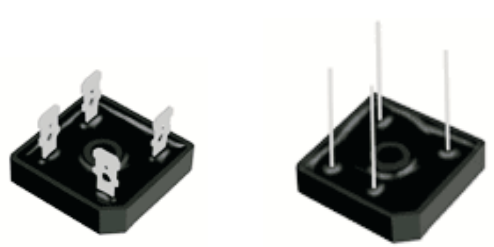
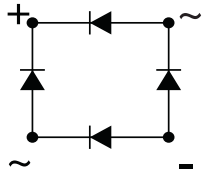

Glass Passivated Single-Phase Bridge Rectifier

<p>Power - Power L</p>  <p>Power Power L</p> 	<p>Voltage</p> <p>50 to 1000 V</p>	<p>Current</p> <p>15-25-35-40-50 A</p>	
	<p>FEATURES</p> <ul style="list-style-type: none"> • High case dielectric strength • High forward surge current capability • UL recognition file number E320541, Vol. 2. • Universal 2-way terminals: snap-on and wire wrap-around / PCB mounting • Low thermal resistance • Compliant to RoHS Directive 2011/65/EU and in accordance to WEEE 2002/96/EC • Solder dip 260°C, 40s • Typical I_{rr} less than 0.3μA 		 <p>RoHS COMPLIANT</p>
	<p>MECHANICAL DATA</p> <ul style="list-style-type: none"> • Case: Power, Power L. Epoxy meets UL 94V-0 flammability rating. • Polarity: As marked, positive lead by beveled corner. • Mounting Torque: 20 inches-lbs. max. • Terminals: Nickel plated on faston lugs or silver plated on wire leads, solderable per J-STD-002 and JESD22-B102. Suffix letter "L" added to indicate wire leads (e.g. FB1501L). 		
	<p>TYPICAL APPLICATIONS</p> <p>Used in ac-to-dc bridge full wave rectification for SMPS, lighting ballaster, adapter, battery charger, home appliances, office equipment, and telecommunication applications.</p>		

Maximun Ratings and Electrical Characteristics at 25 °C

SYMBOL	PARAMETER	FB15-15L, FB25-25L, FB35-35L, FB40, FB50						
		00	01	02	03	06	08	10
V_{RRM}	Peak Recurrent Reverse Voltage (V)	50	100	200	400	600	800	1000
V_{RMS}	Maximum RMS Voltage (V)	35	70	140	280	420	560	700
V_R	Recommended Input Voltage (V)	20	40	80	125	250	380	500
$I_{F(AV)}$	Max. Forward Current R-load At $T_{case} = 55\text{ °C}$	FB15	15 A					
		FB25	25 A					
		FB35	35 A					
		FB40	40 A					
		FB50	50 A					
	Max. Forward Current R-load At $T_{case} = 90\text{ °C}$	FB15	10 A					
		FB25	17 A					
		FB35	20 A					
		FB40	25 A					
		FB50	35 A					
	Max. Forward Current R-load with Al Square Chassis (200 cm ² x 3mm) At $T_{amb} = 45\text{ °C}$	FB15	8 A					
		FB25	10 A					
		FB35	12 A					
		FB40	14 A					
		FB50	16 A					

Glass Passivated Single-Phase Bridge Rectifier
Maximum Ratings and Electrical Characteristics at 25 °C

SYMBOL	PARAMETER	FB15-15L, FB25-25L, FB35-35L, FB40, FB50						
		00	01	02	03	06	08	10
I_{FRM}	Recurrent peak forward current	FB15	60 A					
		FB25	75 A					
		FB35	75 A					
		FB40	100 A					
		FB50	100 A					
I_{FSM}	10 ms. Peak forward surge current	FB15	300 A					
		FB25	300 A					
		FB35	400 A					
		FB40	400 A					
		FB50	400 A					
I^2t	I^2t value for fusing (t = 10 ms)	FB15	450 A ² sec					
		FB25	450 A ² sec					
		FB35	800 A ² sec					
		FB40	800 A ² sec					
		FB50	800 A ² sec					
T_j	Operating Temperature Range	-55 to + 150 °C						
T_{stg}	Storage Temperature Range	-55 to + 150 °C						

Electrical Characteristics at Tamb = 25 °C

V_F	Max. Forward voltage drop per element at	$I_F = 7.5$ A FB15	1.1 V
		$I_F = 12.5$ A FB25	1.1 V
		$I_F = 17.5$ A FB35	1.1 V
		$I_F = 20$ A FB40	1.1 V
		$I_F = 25$ A FB50	1.1 V
I_R	Max. Reverse current per element at V_{RRM}	5 μ A	
R_{thj-c}	Typical Thermal resistance junction to case (Note 1)	1.5 °C/W	
	Isolation voltage from case to leads	2500 Vac	

(Note 1) With heatsink

Glass Passivated Single-Phase Bridge Rectifier
Ordering information

PREFERRED P/N	PACKAGE CODE	DELIVERY MODE	BASE QUANTITY	UNIT WEIGHT (g)
FB2502	POWER	BOX POWER	50	16.5
FB2502L	POWER	BOX POWER L	50	15.6
FB5002	POWER	BOX POWER	50	14.5

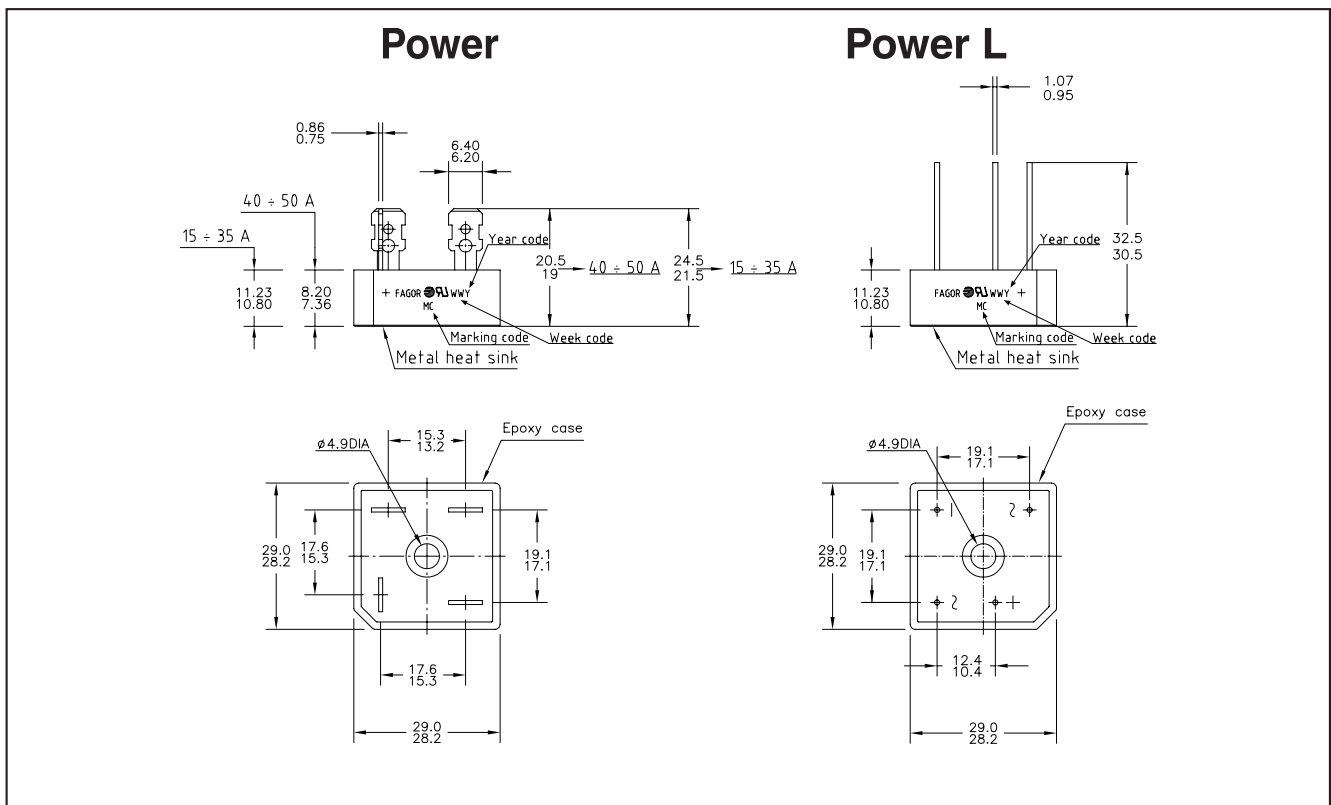
Package Outline Dimensions: (mm) Power - Power L

Glass Passivated Single-Phase Bridge Rectifier

Ratings and Characteristics (Ta 25 °C unless otherwise noted)

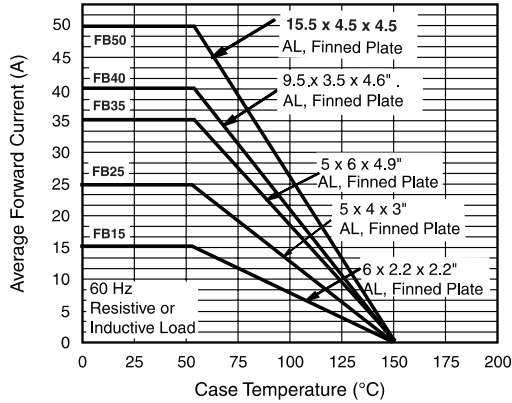

Fig. 1 - Maximum Output Rectified Current

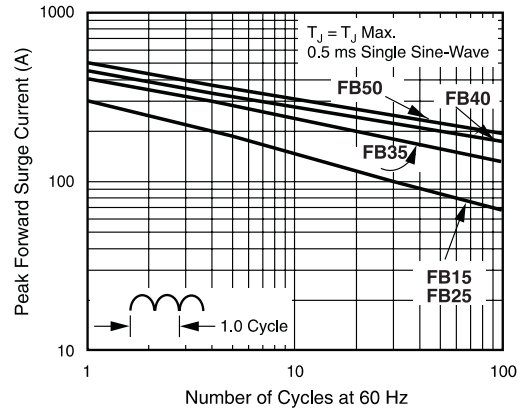

Fig. 4 - Maximum Non-Repetitive Peak Forward Surge Current Per Diode

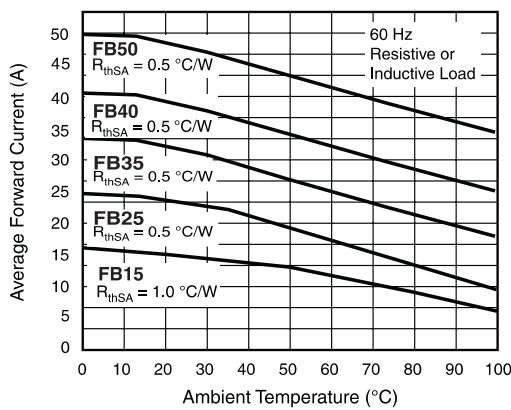

Fig. 2 - Maximum Output Rectified Current

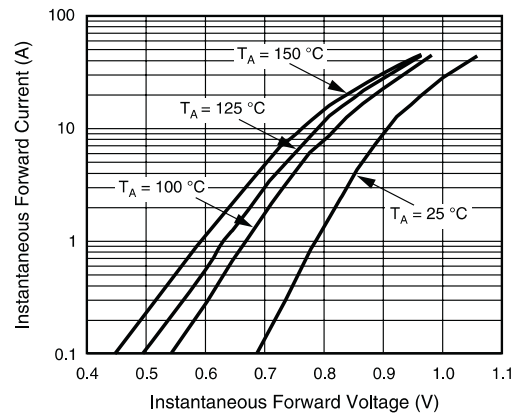

Fig. 5 - Typical Instantaneous Forward Characteristics Per Diode

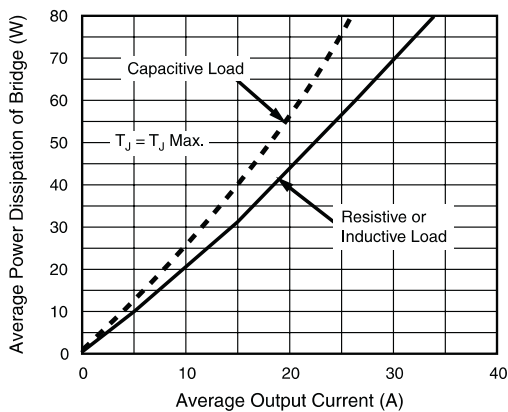

Fig. 3 - Maximum Power Dissipation

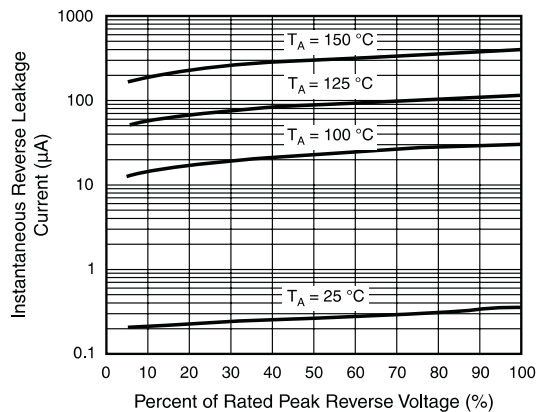

Fig. 6 - Typical Reverse Leakage Characteristics Per Diode

Glass Passivated Single-Phase Bridge Rectifier

Ratings and Characteristics (Ta 25 °C unless otherwise noted)

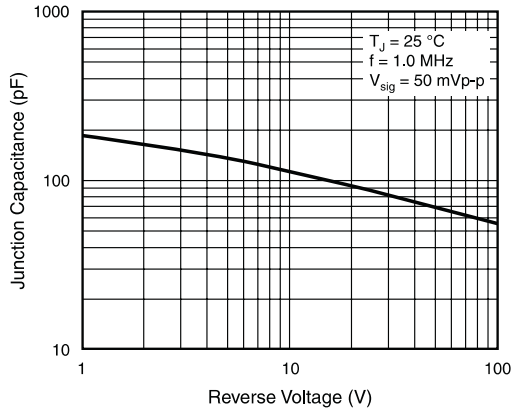

Fig. 7 - Typical Junction Capacitance Per Diode

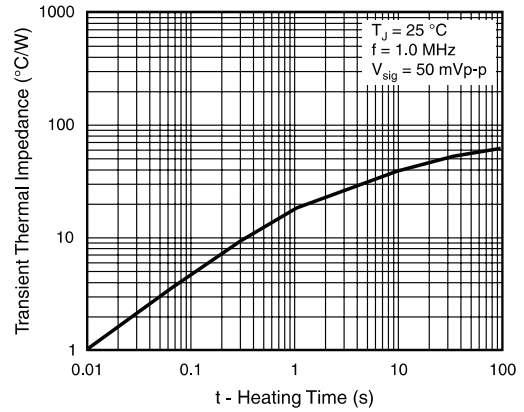

Fig. 8 - Typical Transient Thermal Impedance Per Diode

Glass Passivated Single-Phase Bridge Rectifier**Revision History**

DATE	REVISION	DESCRIPTION OF CHANGES
11-Sep-2012	0	Original Data Sheet
20-Jul-2016	1	Eliminate Power-M family and general review
24-Jan-2018	2	Total height dimension clarified
26-Aug-2020	3	Marking diagram reviewed

Disclaimer

All product, product specifications and data are subject to change without notice to improve reliability, function or design or otherwise.

Fagor Electrónica, S. Coop., its affiliates, agents, and employees, and all persons acting on its or their behalf (collectively, "Fagor"), disclaim any and all liability for any errors, inaccuracies or incompleteness contained in any datasheet or in any other disclosure relating to any product.

Fagor makes no warranty, representation or guarantee regarding the suitability of the products for any particular purpose or the continuing production of any product. To the maximum extent permitted by applicable law, Fagor disclaims (i) any and all liability arising out of the application or use of any product, (ii) any and all liability, including without limitation special, consequential or incidental damages, and (iii) any and implied warranties, including warranties of fitness for particular purpose, non-infringement and merchantability.

Statements regarding the suitability of products for certain types of applications are based on Fagor's knowledge of typical requirements that are often placed on Fagor products in generic applications. Such statements are not binding statements about the suitability of products for a particular application. It is the customer's responsibility to validate that a particular product with the properties described in the product specification is suitable for use in a particular application. Parameters provided in datasheets and/or specifications may vary in different applications and performance may vary over time. All operating parameters, including typical parameters, must be validated for each customer application by the customer's technical experts. Product specifications do not expand or otherwise modify Fagor's terms and conditions or purchase, including but not limited to the warranty expressed therein.

Except as expressly indicated in writing, Fagor products are not designed for use in medical, life-saving, or life-sustaining applications or for any other application in which the failure of the Fagor product could result in personal injury or death. Customers using or selling Fagor products not expressly indicated for use in such applications do so at their own risk and agree to fully indemnify and hold Fagor and its distributors harmless from and against any and all claims, liabilities, expenses and damages arising or resulting in connection with such use or sale, including attorneys fees, even if such claim alleges that Fagor or its distributor was negligent regarding the design or manufacture of the part. Please contact authorized Fagor personnel to obtain written terms and conditions regarding products designed for such applications.

No license, express or implied, by estoppel or otherwise, to any intellectual property rights is granted by this document or by any conduct of Fagor. Products names and markings noted herein may be trademarks of their respective owners.

X-ON Electronics

Largest Supplier of Electrical and Electronic Components

Click to view similar products for [Bridge Rectifiers](#) category:

Click to view products by [Fagor](#) manufacturer:

Other Similar products are found below :

[MB2510](#) [MB252](#) [MB356G](#) [MB358G](#) [90MT160KPBF](#) [GBJ1504-BP](#) [GBU10B-BP](#) [GBU15K-BP](#) [GBU4A-BP](#) [GBU4D-BP](#) [DB101-BP](#) [DF01](#)
[DF10SA-E345](#) [KBPC50-10S](#) [RS405GL-BP](#) [GBJ1502-BP](#) [GBU6M](#) [2KBB10](#) [36MB140A](#) [TB102M](#) [MB1510](#) [MB86](#) [TL401G](#) [MDA920A2](#)
[TU602](#) [TU810](#) [MP5010W-BP](#) [MP501W-BP](#) [MP502-BP](#) [KBPC25-02](#) [VS-110MT120KPBF](#) [VS-60MT80KPBF](#) [DB105-BP](#) [DF1510S](#) [VS-](#)
[40MT160PAPBF](#) [VISKBU8K-E4/51](#) [36MT100](#) [GBU4G-BP](#) [GBU6B-E3/51](#) [GSIB15A80-E3/45](#) [DB104-BP](#) [D3SB60](#) [TB354](#) [26MT140](#)
[36MB40A](#) [GBJ2504-BP](#) [GBPC3504WL-1E4/51](#) [26MB100A](#) [110MT160KPBF](#) [B1S-G](#)