



**Fang cheng Electronics(Dong guan) Co,LTD**  
**SPECIFICATION FOR APPROVAL**

CUSTOMER:

Part Number : CURREN **SENSE TRANSFORMERS**

CUSTOMER Number: 贴片电流互感器

CUSTOMER Part :

Fangcheng part : FC-SCTEE8.3-100-1-30A-T

DATE: 2021-7-8



REV: 02



**Confidential**

made in fangcheng:

CUSTOMER APPROD:

prepad	checd	Approd
 技术部 2021. 7. 08 黄敏	 技术部 2021. 7. 08 刘凡	 技术部 2021. 7. 08 袁宏乐

prepad	checd	Approd

THE INFORMATION CONTAINED IN THIS DOCUMENT IS OF A PROPRIETARY NATURE AND IS INTENDED TO BE KEPT CONFIDENTIAL BETWEEN THE SENDER AND THE INTENDED RECIPIENT. IT MAY NOT BE REPRODUCED OR USED WITHOUT EXPRESS WRITTEN PERMISSION OF FC TECHNOLOGIES, OR FC



方成电子(东莞)有限公司

Tel: +86 0769-82988010

Fax: +86 0769-82988065

E-mail: yhl@fangchengcoils.com

URL: www.fangchengcoils.com

Address: Building 3, Jinmei Technology Park, No.16 Huanchang West Road, Changping Town, Dongguan City

**Fangcheng Electronics (China-Taiwan)**

Address: No. 31, MRT Road, Zhonghe District, New Taipei City

Tel: +8869-983491379



本文件中包含的信息具有专有性质，旨在对发件人和目标收件人之间保密。未经方成（FC）技术或FC明确书面许可，不得复制或提供给第三方使用，TKS

Customer:

made : 方成电子 (东莞) 有限公司

Part Number: FC-SCTEE8.3-100-1-30A-T

Page: 2 ----- 8

## Description of Revision

REV	Description of Revision	DATE	Prepad	Notes
01	Initial Release	2021. 7. 8	<i>zhangli</i>	
02	根据客户要求, 修改电感量测试条件从100KHZ/1修改到1KHZ/0. 3V	2021. 7. 10	袁了	

Prepad <i>zhangli</i>	Checkd <i>Liu-fang</i>	Approd <i>David-yuan</i>
--------------------------	---------------------------	-----------------------------

**Notice of Use**

For the parameters not prescribed in the *Specification for Approval*, please refer to the following standards or the relative industry standards.

1. Product in packing storage condition : temperature 540, RH70%.
  2. A storage of - F C -Electronic products for longer than 12 months is not recommended, Within other effects, the terminals may suffer degradation, resulting in bad solderability. Therefore, all products shall be used within the period of 12 months based on the day of shipment.
  3. Do not keep products in unsuitable storage conditions, such as areas susceptible to high temperatures, high humidity, dust or corrosion.
  - 4 Always handle products with care.
  - 5 Don't touch electrodes directly with bare hands as oil secretions may inhibit soldering.
- Always ensure optimum conditions for soldering.
- 6 When this product will be used on a similar or new project to the original one, sometimes it might be unable to satisfy the specifications due to different condition of usage.
  - 7 This inductor itself does not have any protective function in abnormal condition, such as overload, short-circuit, open-circuit conditions, etc. Therefore, it shall be confirmed that there is no risk of smoke, fire, dielectric withstand voltage, insulation resistance, etc., or use in abnormal conditions protective devices or protection circuit in the end product.
  - 8 Hi-Pot test with higher voltage than spec value will damage insulating material and shorten its life.

IPC 020D Joint Industry standard

IEC1007 《Transformer and inductors for use in electronic and telecommunication equipment—Measuring methods and test procedures》  
 (ROHS or other environmental request)



Prepad  <i>zhangli</i>	Checd  <i>Liu-fang</i>	Approd  <i>David-yuan</i>
------------------------------	------------------------------	---------------------------------

### 1. Appearance and Dimensions(mm)

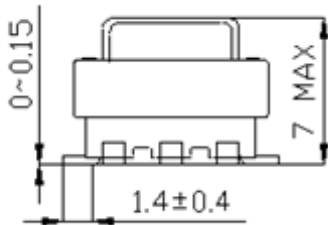
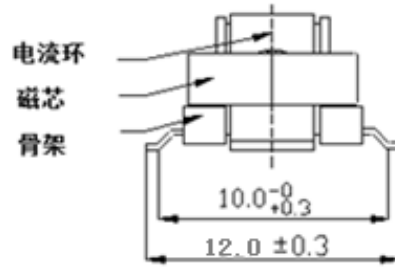
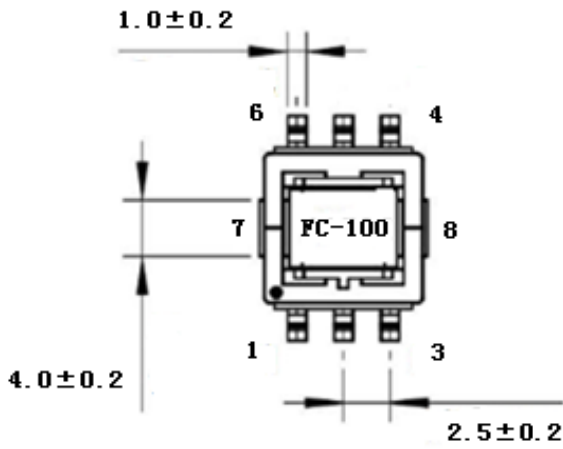

### 2. Schematic :

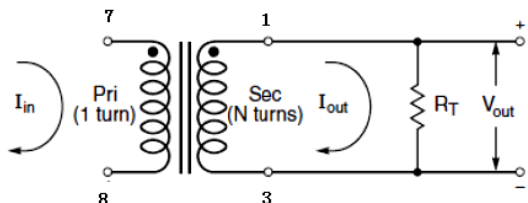
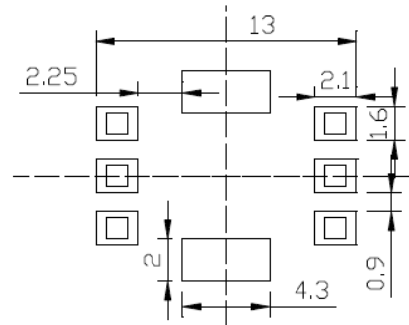

Prepad  <i>zhangli</i>	Checd  <i>Liu-fang</i>	Approd  <i>David-yuan</i>
------------------------------	------------------------------	---------------------------------

#### 4. Electrical Characteristics :

NO.	名称	测量端	测量值	测试条件	测试仪器
1	电感量	L <sub>1-3</sub>	≥3.0mH	1.0kHz 0.3V 25°C	WK3260
2	直流电阻	R <sub>1-3</sub>	3.0Ω typ /3.5Ω MAX	25°C	CH502BC
	直流电阻	R <sub>7-8</sub>	0.2mΩ typ /0.35mΩ MAX	25°C	CH502BC
3	工作电流	I=7-8	30A	1.0kHz 0.3V 25°C	WK3260B
4	抗电强度	N1---N2	DC600V 无异常	1mA/5sec.	CJ2671
5	匝比	N1 : N2	100 : 1	100kHz 1V	WK3260
6	绝缘阻抗	N1-N2-CORE	100MΩ /min	500-VDC	CJ2671

Storage conditions: -20 °C ... +40 °C, 75% RH (packaged)

Operating temperature range: -40 °C ... +125 °C

#### 5. Application circuit and pinning

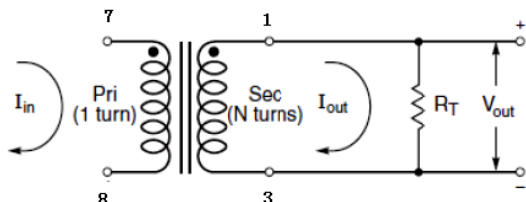

$$B_{max} = \frac{V_{sense,max} \cdot \delta_{max}}{n_s \cdot A_e \cdot f_{osc}}$$

With:

- $B_{max}$  Maximum magnetic flux density in the ferrite core of the current sense transformer
- $V_{sense,max}$  Maximum output voltage of the measurement signal
- $\delta_{max}$  Maximum duty cycle
- $n_s$  Number of turns of the secondary winding of the current sense transformer
- $A_e$  Effective magnetic area of the ferrite core
- $f_{osc}$  Operating frequency of the switching operator IC
- Typical value for  $A_e$ : 4.44mm<sup>2</sup>
- Typical  $B_{max}$ : 200 mT

$$R_T = \frac{V_{sense,max} \cdot n_s}{I_{prim,max}}$$



With:

- $R_T$  Resistance of burden resistor
- $V_{sense,max}$  Maximum output voltage of the measurement signal
- $n_s$  Number of turns on the secondary side of the CT
- $I_{prim,max}$  Maximum primary current (peak current)

Prepad  <i>zhangli</i>	Checd  <i>Liu-fang</i>	Approd  <i>David-yuan</i>
------------------------------	------------------------------	---------------------------------

Customer:

made : 方成电子 (东莞) 有限公司

Part Number: FC-SCTEE8.3-100-1-30A-T

Page: 6 ----- 8

### 6. Reliability and test condition:

Test item	test condition	Remark
Cold Operating Test	GB2423.1 Ad	
Heat Operating Test	GB2423.2 Bd	
Cold Storage Test	GB2423.1 Ab	
Heat Storage Test	GB2423.2 Bb	
Steady Damp Heat Test	GB2423.3 Cb	
Circular Damp Heat Test	GB2423.4 Db	
Temperature Cycling Test	GB2423.22 Nb	
Temperature Shock Test	GB2423.22 Na	
Vibration Test	GB2423.10~15 Fc, Fdb	
Mechanical Shock Test(Bump)	GB2423.5 Eb	
Free Fall Test	GB2423.8 Ed	
Solderability	GJB360A-96	
High Temperature Step Stress Test	Enhancement Test Specifications	
Low Temperature Step Stress Test		
High-speed Thermal Cycling		
Limit Vibration		
Composite Stress		
Highly-Accelerated Temperature and Humidity Stress Test (HAST) (		



Prepad <i>zhangli</i>	Checkd <i>Liu-fang</i>	Approd <i>David-yuan</i>
--------------------------	---------------------------	-----------------------------

**7. Soldering Specification: 元器件的推荐焊接方式是回流焊**

Profile Feature	Sn-Pb Eutectic Assembly	Pb-Free Assembly
Average Ramp-Up Rate (T <sub>Smax</sub> to T <sub>p</sub> )	3 °C/second max.	3° C/second max.
<b>Preheat</b> - Temperature Min (T <sub>Smin</sub> ) - Temperature Max (T <sub>Smax</sub> ) - Time (t <sub>Smin</sub> to t <sub>Smax</sub> )	100 °C 150 °C 60-120 seconds	150 °C 200 °C 60-180 seconds
Time maintained above: - Temperature (T <sub>L</sub> ) - Time (t <sub>L</sub> )	183 °C 60-150 seconds	217 °C 60-150 seconds
Peak/Classification Temperature (T <sub>p</sub> )	See Table 4.1	See Table 4.2
Time within 5 °C of actual Peak Temperature (t <sub>p</sub> )	10-30 seconds	20-40 seconds
Ramp-Down Rate	6 °C/second max.	6 °C/second max.
Time 25 °C to Peak Temperature	6 minutes max.	8 minutes max.

Note 1: All temperatures refer to topside of the package, measured on the package body surface.

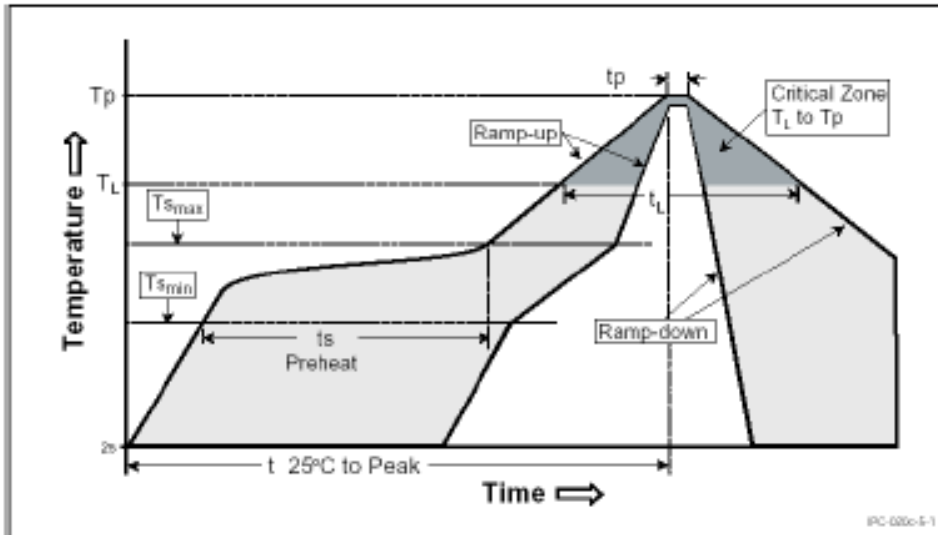

Package Thickness	Volume mm <sup>3</sup> <350	Volume mm <sup>3</sup> 350 - 2000	Volume mm <sup>3</sup> >2000
<1.6 mm	260 +0 °C *	260 +0 °C *	260 +0 °C *
1.6 mm - 2.5 mm	260 +0 °C *	250 +0 °C *	245 +0 °C *
≥2.5 mm	250 +0 °C *	245 +0 °C *	245 +0 °C *

\* Tolerance: The device manufacturer/supplier shall assure process compatibility up to and including the stated classification temperature (this means Peak reflow temperature +0 °C. For example 260 °C+0°C) at the rated MSL level.

7.1 高温耐热性: 在260°C的熔融钎料中, 停留时间不少于10 秒, 无质量问题。

7.2 返修温度和时间温度: 350 度; 时间: 不少于5 秒。

7.3 焊接次数: 元器件能承受的焊接次数不少于5 次

Prepad <i>zhangli</i>	Checkd <i>Liu-fang</i>	Approd <i>David-yuan</i>
--------------------------	---------------------------	-----------------------------

### 8.1 包装:

- 1) 包装箱上应标明产品型号、名称、数量、出厂日期、承制方名称及出厂检验章;
- 2) 货物运达客户方后, 包装箱封条应完好, 箱体无破损、开裂等现象;
- 3) 电感用木箱或其他材料包装, 方便拆卸, 四周用软性材料填充;

**数量: 500PCS/R , 产品 1 脚朝向带孔方向。**

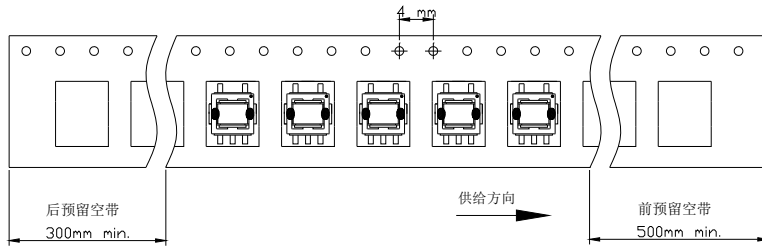

### 8.2 外观:

- 1) 产品应有合格证和耐擦防水洗标签, 应注明型号、规格;
- 2) 产品外观整洁, 应无破损、划伤;

### 8.3 检验:

- 1) 产品生产中必须全数进行电气性能, 抗电强度检测; 箱内应有 100% 电气性能合格保证书或检测报告;
- 2) 产品出货前按批次, 必须根据承认书按国家行业标准进行抽样检验, 合格后出具出厂检验报告, 记录抽样测试数据, 在每批次包装尾箱中放置一份; 检验报告须注明 100% 耐压测试合格。注: 批次按定单号发货为准



Prepad

*zhangli*

Checd

*Liu-fang*

Approd

*David-yuan*



## X-ON Electronics

Largest Supplier of Electrical and Electronic Components

*Click to view similar products for [FANGCHENG manufacturer](#):*

Other Similar products are found below :

[FC-SLF1813-251-6A-LF](#) [FC-SCT1010-1:150T-40A](#) [FC-SLF1285-5.0mH-2.0A-LF](#) [FC-DLSF1010-5mH-3.5A-L](#) [FC-SLF1813-10mH-2.5A-LF](#) [FC-SLF2210-431-LF](#) [FC-DLF4030-141-120A-LF](#) [FC-SLF1810-901-LF](#) [FC-SCT1010-1:200T-40A](#) [FC-SCT1010-1:50T-40A](#) [FC-SCT1010-1:180T-40A](#) [FC-SCT1090-200T-50A](#) [FC-SCT1010-1:125T-40A](#) [FC-SCT1010-1:70T-40A](#) [FC-UU16-452-3.5A-LF](#) [FC-SLF0502-101YL](#) [FC-DLF1015-161B-LF](#) [FC-SLF1812-202Y](#) [FC-SCT2010-100T](#) [FC-SLF0904-513DL](#) [FC-SCT2010-200T](#) [FC-ACT25-50A-1000T-1T](#) [FC-DLSF2515-1.0mH/30A-L](#) [FC-SLF0502-102YL](#) [FC-SLF1212T-25mH-2.5A-LF](#) [FC-SLF0502-251YL](#) [FC-SCT4.6-1:70](#) [FC-SLF1050-501-LF](#) [FC-SLF1050-801-LF](#) [FC-SLF1820-473](#) [FC-LSFW4532-102S](#) [FC-SLF0504-102](#) [FC-SLF1050-102-LF](#) [LCM1211-272](#) [FC20100310](#) [FC20330210](#) [FC-SLF0905-510Y](#) [FC20150210](#) [FC20680210](#) [FC20470210](#) [FC-DLFH2520H-102Y-LF](#) [FC-DLFH2520-102Y-LF](#) [FC-ULCT1013-1:200-35A](#) [FC-UU9.8-5.0mH-2.5A](#) [FC-SE2915-100M](#) [FC-SLF1285-10mH-1.5A-LF](#) [FC-LF1608-3.5mH-6.0A-L](#) [FC-SLF1065-221](#) [FC-SLF1515T-2.5mH-7.5A-LF](#) [FC-SLF0904-510YL](#)