

RoHS
Compliant



SPECIFICATION FOR APPROVAL

File No.: Q/FRK 0.GS.E.C23-C12

Product Name Box-type metallized polyester film capacitor
Product Type: C23(CL23 Series)
Product Code
Customer
Customer Code
Issue Date 2020-03

Xiamen Faratronic Co. Ltd.			Approved by Customer
Drafted	Checked	Approved	



Xiamen Faratronic Co. Ltd.

Add: 99 Xinyuan Road, Haicang District, Xiamen, China

Marketing/Sales center

TEL: 0086-592-6208620 6208505 6208586

FAX: 0086-592-6208777

Mail: Vitawang@faratronic.com.cn

Donny@faratronic.com.cn

James@faratronic.com.cn

Http: www.faratronic.com.cn

*.The specification are the property of Xiamen Faratronic Co.Ltd and shall not be copied or used as commercial purposes without permission.

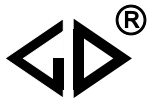

Version history

Current version	Date	Author	Change description

Metallized polyester film capacitor (Box-type)

■ Outline Drawing

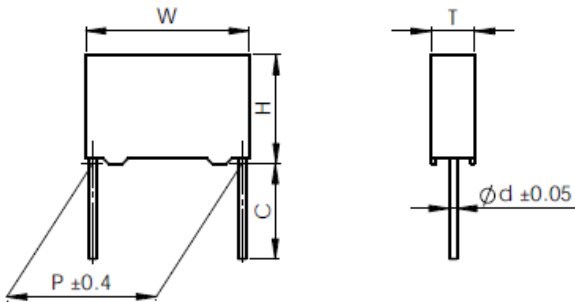

$W \pm 0.4, H \pm 0.4, T \pm 0.4$

■ Features

- High reliability
- Metallized polyester film, non-inductive wound construction
- Plastic case(UL94 V-0), epoxy resin sealing

■ Typical application

- by-passing, blocking, coupling, decoupling,
- pulse, logic, timing, oscillator circuits.

■ Specifications

Reference Standard	GB 7332 (IEC 60384-2)					
Climatic Category	55/105/56					
Rated temperature	85°C					
Operating temperature	-55°C~105°C (+85°C to +105°C: decreasing factor 1.25% per °C for U_R)					
Rated Voltage	63V, 100V, 250V, 400V, 630V, 1 000V					
Capacitance Range	0.0010 μ F~47.0 μ F					
Capacitance Tolerance	$\pm 5\%$ (J), $\pm 10\%$ (K), $\pm 20\%$ (M)					
Voltage Proof	1.6 U_R (5s)					
Dissipation Factor	$\leq 1.0\%$ (20°C,1kHz)					
Insulation Resistance	$U_R > 100V$	$R \geq 30\,000M\Omega,$ $RC_N \geq 10\,000\,s,$	$C_R \leq 0.33\mu F$ $C_R > 0.33\mu F$	(20°C,100V,1min)		
	$U_R \leq 100V$	$R \geq 3\,750M\Omega,$ $RC_N \geq 1\,250s,$	$C_N \leq 0.33\mu F$ $C_N > 0.33\mu F$	(20°C,10V,1min)		
Maximum Pulse Rise Time(dV/dt) If the working voltage(U) is lower than the rated voltage(U_R),the capacitor can be worked at a higher dV/dt. In this case, the maximum allowed dV/dt is obtain by multiplying the right value with U_R/U .	U_R (V)	dV/dt (V/ μ s)				
		P=7.5	P=10.0	P=15.0	P=22.5	P=27.5
	63	7.5	6	3	2	1
	100	15	9	5	3	2
	250	30	20	12	8	5
	400	40	30	20	10	7
	630	50	40	25	12	10
1 000	70	60	30	15	12	

■ Part number system

The 15 digits part number is formed as follow:

1	2	3	4	5	6	7	8	9	10	11	12	13	14	15
C	2	3												

Digit 1 to 3 Series code

C23=CL23

Digit 4 to 5 DC rated voltage

1J=63V 2A=100V 2C=160V 2E=250V 2G=400V 2J=630V 3A=1 000V

Digit 6 to 8 Rated capacitance value

For example: 103=10×10³ pF= 0.01μF

Digit 9 Capacitance tolerance

J=±5%,K=±10%, M=±20%

Digit 10 Lead pitch

3=7.5mm 4=10.0mm 6=15.0mm 9=22.5mm B=27.5mm

Digit 11 Internal use

Digit 12 to 15 Lead form and packaging code

Table 1 Lead form and packaging code

Digit 12		Digit 13		Digit 14		Digit 15	
code	explanation	code	explanation	code	explanation	code	explanation
A	ammo-pack	3	F=7.5mm	0	straight	1	each cap. among two consecutive holes P3=12.7mm,H=18.5mm (For pitch=7.5mm)
		4	F=10.0mm			5	P3=25.4mm;H=18.5mm (For pitch=10/15mm)
		6	F=15.0mm				
C	straight lead “C” in the figure above	code	explanation	0		0	Length tolerance ±0.5mm Or standard length
		00	standard lead length (18mm~26mm)				
		45	lead length 4.5mm				
Note: Recommend short lead due to long lead could deform easily.							



■ **Dimensions (mm)**

Pattern II (Reduced sizes)

63Vdc (40Vac)						
C _N (μF)	W ±0.4	H ±0.4	T ±0.4	P ±0.4	d	Part number
0.47	10.5	8.5	3.5	7.5	0.5	C231J474-3S****
0.68	10.5	9.0	4.0	7.5	0.6	C231J684-3S****
1.0	10.5	11.0	5.0	7.5	0.6	C231J105-3S****
1.5	10.5	12.0	6.0	7.5	0.6	C231J155-3S****
1.8	10.5	12.0	6.0	7.5	0.6	C231J185-3S****
0.10	13.0	9.0	4.0	10.0	0.6	C231J104-4S****
0.15	13.0	9.0	4.0	10.0	0.6	C231J154-4S****
0.22	13.0	9.0	4.0	10.0	0.6	C231J224-4S****
0.33	13.0	9.0	4.0	10.0	0.6	C231J334-4S****
0.47	13.0	9.0	4.0	10.0	0.6	C231J474-4S****
0.68	13.0	9.0	4.0	10.0	0.6	C231J684-4S****
1.0	13.0	9.0	4.0	10.0	0.6	C231J105-4S****
1.5	13.0	11.0	5.0	10.0	0.6	C231J155-4S****
1.8	13.0	12.0	6.0	10.0	0.6	C231J185-4S****
2.2	13.0	12.0	6.0	10.0	0.6	C231J225-4S****
0.68	17.5	11.0	5.0	15.0	0.8	C231J684-6S****
1.0	17.5	11.0	5.0	15.0	0.8	C231J105-6S****
1.5	17.5	11.0	5.0	15.0	0.8	C231J155-6S****
1.8	17.5	11.0	5.0	15.0	0.8	C231J185-6S****
2.2	17.5	11.0	5.0	15.0	0.8	C231J225-6S****
3.3	17.5	12.0	6.0	15.0	0.8	C231J335-6S****
4.7	17.5	13.5	7.5	15.0	0.8	C231J475-6S****
6.8	17.5	14.5	8.5	15.0	0.8	C231J685-6S****
10.0	17.5	19.0	11.0	15.0	0.8	C231J106-6S****
3.3	26.5	16.0	7.0	22.5	0.8	C231J335-9S****
4.7	26.5	16.0	7.0	22.5	0.8	C231J475-9S****
6.8	26.5	16.0	7.0	22.5	0.8	C231J685-9S****
10.0	26.5	17.0	8.5	22.5	0.8	C231J106-9S****
15.0	26.5	20.0	11.0	22.5	0.8	C231J156-9S****
4.7	32.0	18.0	9.0	27.5	0.8	C231J475-BS****
6.8	32.0	18.0	9.0	27.5	0.8	C231J685-BS****
10.0	32.0	18.0	9.0	27.5	0.8	C231J106-BS****
15.0	32.0	18.0	9.0	27.5	0.8	C231J156-BS****
22.0	32.0	22.0	13.0	27.5	0.8	C231J226-BS****
33.0	32.0	24.5	15.0	27.5	0.8	C231J336-BS****
47.0	32.0	30.0	16.0	27.5	0.8	C231J476-BS****

100Vdc (63Vac)						
C _N (μF)	W ±0.4	H ±0.4	T ±0.4	P ±0.4	d	Part number
0.22	10.5	8.5	3.5	7.5	0.5	C232A224-3S****
0.33	10.5	9.0	4.0	7.5	0.6	C232A334-3S****
0.39	10.5	9.0	4.0	7.5	0.6	C232A394-3S****
0.47	10.5	9.0	4.0	7.5	0.6	C232A474-3S****
0.68	10.5	11.0	5.0	7.5	0.6	C232A684-3S****
1.0	10.5	12.0	6.0	7.5	0.6	C232A105-3S****
0.10	13.0	9.0	4.0	10.0	0.6	C232A104-4S****
0.15	13.0	9.0	4.0	10.0	0.6	C232A154-4S****
0.22	13.0	9.0	4.0	10.0	0.6	C232A224-4S****
0.33	13.0	9.0	4.0	10.0	0.6	C232A334-4S****
0.47	13.0	9.0	4.0	10.0	0.6	C232A474-4S****
0.68	13.0	9.0	4.0	10.0	0.6	C232A684-4S****
1.0	13.0	11.0	5.0	10.0	0.6	C232A105-4S****
1.5	13.0	12.0	6.0	10.0	0.6	C232A155-4S****
0.33	17.5	11.0	5.0	15.0	0.8	C232A334-6S****
0.47	17.5	11.0	5.0	15.0	0.8	C232A474-6S****
0.68	17.5	11.0	5.0	15.0	0.8	C232A684-6S****
1.0	17.5	11.0	5.0	15.0	0.8	C232A105-6S****
1.5	17.5	12.0	6.0	15.0	0.8	C232A155-6S****
1.8	17.5	12.0	6.0	15.0	0.8	C232A185-6S****
2.2	17.5	12.0	6.0	15.0	0.8	C232A225-6S****
3.3	17.5	13.5	7.5	15.0	0.8	C232A335-6S****
4.7	17.5	14.5	8.5	15.0	0.8	C232A475-6S****
1.5	26.5	15.0	6.0	22.5	0.8	C232A155-9S****
1.8	26.5	15.0	6.0	22.5	0.8	C232A185-9S****
2.2	26.5	15.0	6.0	22.5	0.8	C232A225-9S****
3.3	26.5	15.0	6.0	22.5	0.8	C232A335-9S****
4.7	26.5	16.0	7.0	22.5	0.8	C232A475-9S****
6.8	26.5	18.5	10.0	22.5	0.8	C232A685-9S****
10.0	26.5	22.0	12.0	22.5	0.8	C232A106-9S****
4.7	32.0	18.0	9.0	27.5	0.8	C232A475-BS****
6.8	32.0	18.0	9.0	27.5	0.8	C232A685-BS****
10.0	32.0	20.0	11.0	27.5	0.8	C232A106-BS****
15.0	32.0	20.0	11.0	27.5	0.8	C232A156-BS****
22.0	32.0	25.0	13.0	27.5	0.8	C232A226-BS****
33.0	32.0	30.0	16.0	27.5	0.8	C232A336-BS****

Note: 1. “-”=capacitance tolerance code, M=±20%,K=±10%,J=±5%
2. “****”=lead form and packing code (refer to table 1).

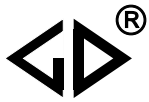

■ **Dimensions (mm)**

Pattern II (Reduced sizes)

250Vdc (160Vac)						
C _N (μF)	W ±0.4	H ±0.4	T ±0.4	P ±0.4	d	Part number
0.068	10.5	8.5	3.5	7.5	0.5	C232E683-3S****
0.10	10.5	8.5	3.5	7.5	0.5	C232E104-3S****
0.15	10.5	9.0	4.0	7.5	0.6	C232E154-3S****
0.18	10.5	11.0	5.0	7.5	0.6	C232E184-3S****
0.22	10.5	11.0	5.0	7.5	0.6	C232E224-3S****
0.27	10.5	12.0	6.0	7.5	0.6	C232E274-3S****
0.33	10.5	12.0	6.0	7.5	0.6	C232E334-3S****
0.033	13.0	9.0	4.0	10.0	0.6	C232E333-4S****
0.047	13.0	9.0	4.0	10.0	0.6	C232E473-4S****
0.068	13.0	9.0	4.0	10.0	0.6	C232E683-4S****
0.10	13.0	9.0	4.0	10.0	0.6	C232E104-4S****
0.15	13.0	9.0	4.0	10.0	0.6	C232E154-4S****
0.22	13.0	11.0	5.0	10.0	0.6	C232E224-4S****
0.33	13.0	11.0	5.0	10.0	0.6	C232E334-4S****
0.39	13.0	12.0	6.0	10.0	0.6	C232E394-4S****
0.47	13.0	12.0	6.0	10.0	0.6	C232E474-4S****
0.10	17.5	11.0	5.0	15.0	0.8	C232E104-6S****
0.15	17.5	11.0	5.0	15.0	0.8	C232E154-6S****
0.22	17.5	11.0	5.0	15.0	0.8	C232E224-6S****
0.33	17.5	11.0	5.0	15.0	0.8	C232E334-6S****
0.47	17.5	11.0	5.0	15.0	0.8	C232E474-6S****
0.68	17.5	12.0	6.0	15.0	0.8	C232E684-6S****
1.0	17.5	13.5	7.5	15.0	0.8	C232E105-6S****
1.5	17.5	14.5	8.5	15.0	0.8	C232E155-6S****
0.22	26.5	15.0	6.0	22.5	0.8	C232E224-9S****
0.47	26.5	15.0	6.0	22.5	0.8	C232E474-9S****
0.68	26.5	15.0	6.0	22.5	0.8	C232E684-9S****
1.0	26.5	15.0	6.0	22.5	0.8	C232E105-9S****
1.5	26.5	16.0	7.0	22.5	0.8	C232E155-9S****
1.8	26.5	16.0	7.0	22.5	0.8	C232E185-9S****
2.2	26.5	17.0	8.5	22.5	0.8	C232E225-9S****
3.3	26.5	20.0	11.0	22.5	0.8	C232E335-9S****
1.5	32.0	18.0	9.0	27.5	0.8	C232E155-BS****
1.8	32.0	18.0	9.0	27.5	0.8	C232E185-BS****
2.2	32.0	18.0	9.0	27.5	0.8	C232E225-BS****
3.3	32.0	18.0	9.0	27.5	0.8	C232E335-BS****
4.7	32.0	20.0	11.0	27.5	0.8	C232E475-BS****
6.8	32.0	22.0	13.0	27.5	0.8	C232E685-BS****
10.0	32.0	24.5	15.0	27.5	0.8	C232E106-BS****

400Vdc (200Vac)						
C _N (μF)	W ±0.4	H ±0.4	T ±0.4	P ±0.4	d	Part number
0.022	10.5	8.5	3.5	7.5	0.5	C232G223-3S****
0.033	10.5	8.5	3.5	7.5	0.5	C232G333-3S****
0.047	10.5	9.0	4.0	7.5	0.6	C232G473-3S****
0.068	10.5	11.0	5.0	7.5	0.6	C232G683-3S****
0.082	10.5	12.0	6.0	7.5	0.6	C232G823-3S****
0.10	10.5	12.0	6.0	7.5	0.6	C232G104-3S****
0.010	13.0	9.0	4.0	10.0	0.6	C232G103-4S****
0.015	13.0	9.0	4.0	10.0	0.6	C232G153-4S****
0.022	13.0	9.0	4.0	10.0	0.6	C232G223-4S****
0.033	13.0	9.0	4.0	10.0	0.6	C232G333-4S****
0.047	13.0	9.0	4.0	10.0	0.6	C232G473-4S****
0.056	13.0	9.0	4.0	10.0	0.6	C232G563-4S****
0.068	13.0	11.0	5.0	10.0	0.6	C232G683-4S****
0.10	13.0	11.0	5.0	10.0	0.6	C232G104-4S****
0.15	13.0	12.0	6.0	10.0	0.6	C232G154-4S****
0.047	17.5	11.0	5.0	15.0	0.8	C232G473-6S****
0.068	17.5	11.0	5.0	15.0	0.8	C232G683-6S****
0.10	17.5	11.0	5.0	15.0	0.8	C232G104-6S****
0.15	17.5	11.0	5.0	15.0	0.8	C232G154-6S****
0.22	17.5	12.0	6.0	15.0	0.8	C232G224-6S****
0.33	17.5	13.5	7.5	15.0	0.8	C232G334-6S****
0.47	17.5	14.5	8.5	15.0	0.8	C232G474-6S****
0.56	17.5	16.0	10.0	15.0	0.8	C232G564-6S****
0.68	17.5	16.0	10.0	15.0	0.8	C232G684-6S****
0.22	26.5	15.0	6.0	22.5	0.8	C232G224-9S****
0.33	26.5	15.0	6.0	22.5	0.8	C232G334-9S****
0.47	26.5	15.0	6.0	22.5	0.8	C232G474-9S****
0.68	26.5	16.0	7.0	22.5	0.8	C232G684-9S****
1.0	26.5	18.50	10.0	22.5	0.8	C232G105-9S****
1.5	26.5	22.0	12.0	22.5	0.8	C232G155-9S****
0.68	32.0	18.0	9.0	27.5	0.8	C232G684-BS****
1.0	32.0	18.0	9.0	27.5	0.8	C232G105-BS****
1.5	32.0	20.0	11.0	27.5	0.8	C232G155-BS****
1.8	32.0	20.0	11.0	27.5	0.8	C232G185-BS****
2.2	32.0	22.0	13.0	27.5	0.8	C232G225-BS****
3.3	32.0	24.5	15.0	27.5	0.8	C232G335-BS****
4.7	32.0	30.0	16.0	27.5	0.8	C232G475-BS****
6.8	32.0	33.0	18.0	27.5	0.8	C232G685-BS****

Note: 1. “-”=capacitance tolerance code, M=±20%,K=±10%,J=±5%
2. “****”=lead form and packing code (refer to table 1).

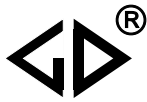

■ **Dimensions (mm)**

Pattern II (Reduced sizes)

630Vdc (220Vac) [@]						
C _N (μF)	W ±0.4	H ±0.4	T ±0.4	P ±0.4	d	Part number
0.0022	10.5	8.5	3.5	7.5	0.5	C232J222-3S****
0.0047	10.5	8.5	3.5	7.5	0.5	C232J472-3S****
0.0068	10.5	8.5	3.5	7.5	0.5	C232J682-3S****
0.010	10.5	8.5	3.5	7.5	0.5	C232J103-3S****
0.015	10.5	9.0	4.0	7.5	0.6	C232J153-3S****
0.022	10.5	11.0	5.0	7.5	0.6	C232J223-3S****
0.033	10.5	12.0	6.0	7.5	0.6	C232J333-3S****
0.047	10.5	12.0	6.0	7.5	0.6	C232J473-3S****
0.0047	13.0	9.0	4.0	10.0	0.6	C232J472-4S****
0.0068	13.0	9.0	4.0	10.0	0.6	C232J682-4S****
0.010	13.0	9.0	4.0	10.0	0.6	C232J103-4S****
0.015	13.0	9.0	4.0	10.0	0.6	C232J153-4S****
0.022	13.0	9.0	4.0	10.0	0.6	C232J223-4S****
0.033	13.0	11.0	5.0	10.0	0.6	C232J333-4S****
0.047	13.0	11.0	5.0	10.0	0.6	C232J473-4S****
0.068	13.0	12.0	6.0	10.0	0.6	C232J683-4S****
0.033	17.5	11.0	5.0	15.0	0.8	C232J333-6S****
0.047	17.5	11.0	5.0	15.0	0.8	C232J473-6S****
0.068	17.5	11.0	5.0	15.0	0.8	C232J683-6S****
0.10	17.5	12.0	6.0	15.0	0.8	C232J104-6S****
0.15	17.5	13.5	7.5	15.0	0.8	C232J154-6S****
0.22	17.5	16.0	10.0	15.0	0.8	C232J224-6S****
0.33	17.5	19.0	11.0	15.0	0.8	C232J334-6S****
0.10	26.5	15.0	6.0	22.5	0.8	C232J104-9S****
0.15	26.5	15.0	6.0	22.5	0.8	C232J154-9S****
0.22	26.5	16.0	7.0	22.5	0.8	C232J224-9S****
0.33	26.5	16.0	7.0	22.5	0.8	C232J334-9S****
0.47	26.5	17.0	8.5	22.5	0.8	C232J474-9S****
0.68	26.5	22.0	12.0	22.5	0.8	C232J684-9S****
0.33	32.0	18.0	9.0	27.5	0.8	C232J334-BS****
0.47	32.0	18.0	9.0	27.5	0.8	C232J474-BS****
0.68	32.0	20.0	11.0	27.5	0.8	C232J684-BS****
1.0	32.0	20.0	11.0	27.5	0.8	C232J105-BS****

1 000Vdc (300Vac)						
C _N (μF)	W ±0.4	H ±0.4	T ±0.4	P ±0.4	d	Part number
0.0010	10.5	8.5	3.5	7.5	0.5	C233A102-3S****
0.0015	10.5	8.5	3.5	7.5	0.5	C233A152-3S****
0.0022	10.5	8.5	3.5	7.5	0.5	C233A222-3S****
0.0033	10.5	8.5	3.5	7.5	0.5	C233A332-3S****
0.0047	10.5	8.5	3.5	7.5	0.5	C233A472-3S****
0.0068	10.5	9.0	4.0	7.5	0.6	C233A682-3S****
0.010	10.5	11.0	5.0	7.5	0.6	C233A103-3S****
0.015	10.5	12.0	6.0	7.5	0.6	C233A153-3S****
0.0010	13.0	9.0	4.0	10.0	0.6	C233A102-4S****
0.0015	13.0	9.0	4.0	10.0	0.6	C233A152-4S****
0.0022	13.0	9.0	4.0	10.0	0.6	C233A222-4S****
0.0033	13.0	9.0	4.0	10.0	0.6	C233A332-4S****
0.0047	13.0	9.0	4.0	10.0	0.6	C233A472-4S****
0.0056	13.0	9.0	4.0	10.0	0.6	C233A562-4S****
0.0068	13.0	9.0	4.0	10.0	0.6	C233A682-4S****
0.010	13.0	9.0	4.0	10.0	0.6	C233A103-4S****
0.015	13.0	11.0	5.0	10.0	0.6	C233A153-4S****
0.022	13.0	11.0	5.0	10.0	0.6	C233A223-4S****
0.010	17.5	11.0	5.0	15.0	0.8	C233A103-6S****
0.015	17.5	11.0	5.0	15.0	0.8	C233A153-6S****
0.022	17.5	11.0	5.0	15.0	0.8	C233A223-6S****
0.033	17.5	12.0	6.0	15.0	0.8	C233A333-6S****
0.047	17.5	12.0	6.0	15.0	0.8	C233A473-6S****
0.068	17.5	13.5	7.5	15.0	0.8	C233A683-6S****
0.10	17.5	14.5	8.5	15.0	0.8	C233A104-6S****
0.033	26.5	15.0	6.0	22.5	0.8	C233A333-9S****
0.047	26.5	15.0	6.0	22.5	0.8	C233A473-9S****
0.068	26.5	15.0	6.0	22.5	0.8	C233A683-9S****
0.10	26.5	15.0	6.0	22.5	0.8	C233A104-9S****
0.15	26.5	16.0	7.0	22.5	0.8	C233A154-9S****
0.22	26.5	17.0	8.5	22.5	0.8	C233A224-9S****
0.33	26.5	20.0	11.0	22.5	0.8	C233A334-9S****
0.15	32.0	18.0	9.0	27.5	0.8	C233A154-BS****
0.22	32.0	18.0	9.0	27.5	0.8	C233A224-BS****
0.33	32.0	20.0	11.0	27.5	0.8	C233A334-BS****
0.47	32.0	20.0	11.0	27.5	0.8	C233A474-BS****
0.68	32.0	28.0	14.0	27.5	0.8	C233A684-BS****
1.0	32.0	30.0	16.0	27.5	0.8	C233A105-BS****
1.5	32.0	37.0	22.0	27.5	0.8	C233A155-BS****

- Note: 1. “-”=capacitance tolerance code, M=±20%,K=±10%,J=±5%
 2. “****”=lead form and packing code (refer to table 1).
 3. “@” Not suitable for across-the-line applications. Pls refer to the Interference Suppression Capacitors.

■ MAX. VOLTAGE(Vr.m.s) VERSUS FREQUENCY

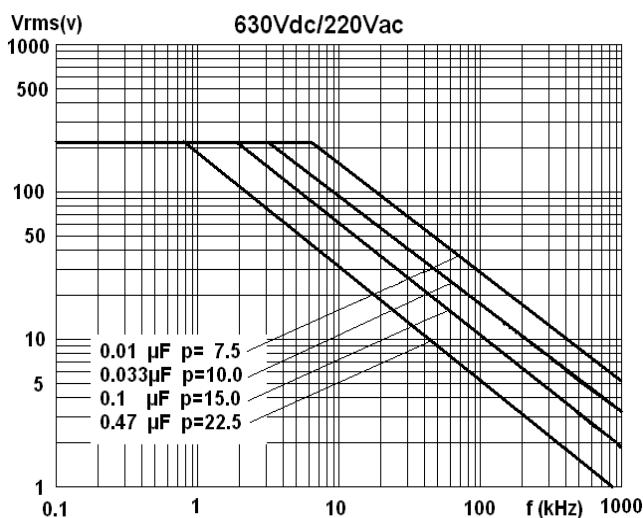
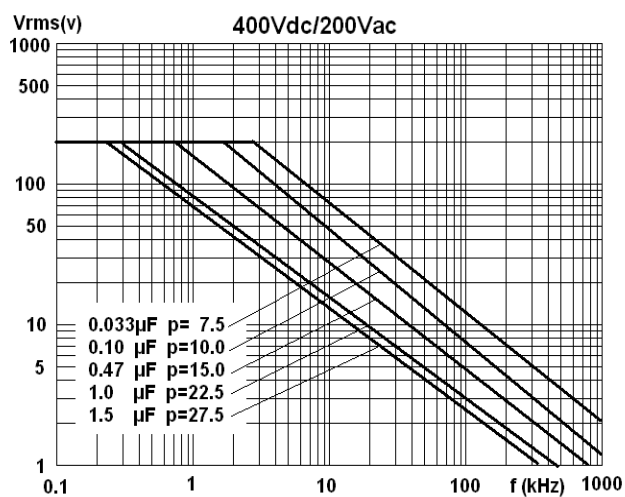
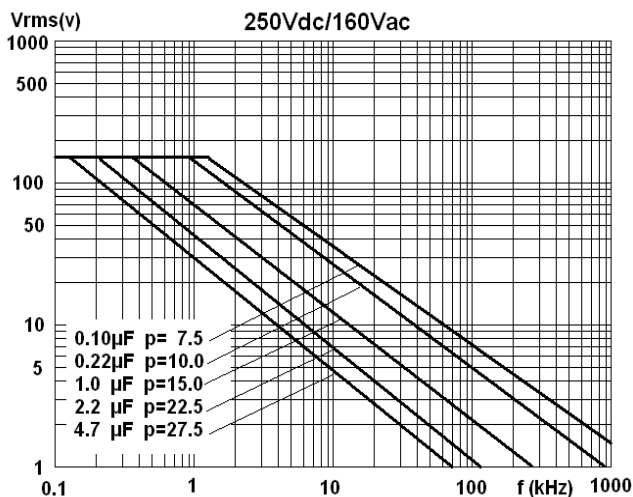
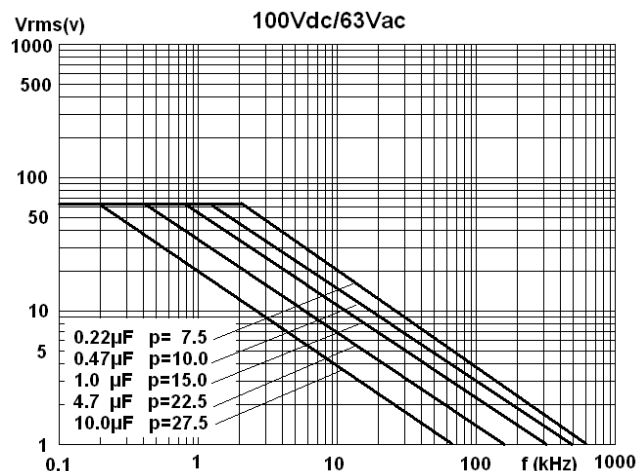
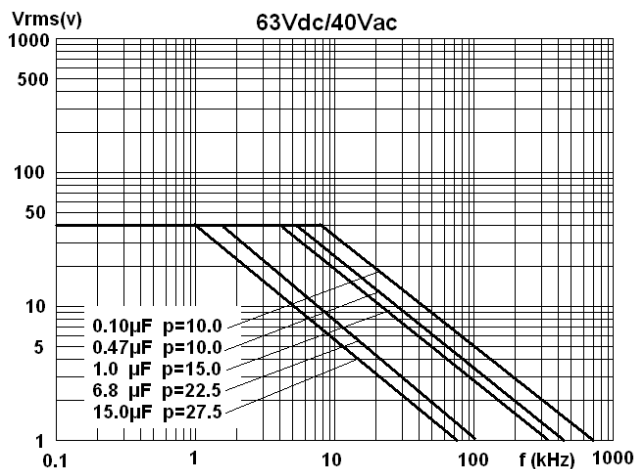

Note: sinusoidal wave-form, environment temperature $\leq 85^{\circ}\text{C}$, internal temperature rise $\Delta T = 15^{\circ}\text{C}$, p (pitch) in mm..

■ Test Method And Performance

No.	Item	Performance	Test method (GB 7332(IEC 60384-2))
1	Solderability	Good quality of tinning	Solder temperature:245°C±5°C Immersion time: 2.0s±0.5s
2	Initial measurement	Capacitance, Tgδ	
	Terminal strength (straight lead)	There shall be no visible damage	Tension Ua1: Pull: φd=0.5mm,5N φd≥0.6mm, 10N Bend Ub: The pull of bend: φd=0.5mm, 2.5N φd≥0.6mm, 5N The terminals shall be bent 2 times in each direction.
	Resistance to solder heat	There shall be no visible damage, legible marking	Solder temperature:260°C±5°C Immersion time: 10s±1s
	Final measurement	ΔC/C ≤±2%(relative to the initial value) Increase of tgδ: ≤0.003 (C≤1.0μF) ≤0.002 (C>1.0μF)	
3	Initial measurement	Capacitance, Tgδ	
	Rapid change of temperature	There shall be no evidence of deterioration.	θ _A =-55°C, θ _B =+105°C 5 cycles Duration: t=30min
	Vibration(straight lead)	There shall be no evidence of deterioration.	Amplitude 0.75mm or acceleration 98m/s ² (whichever is the smaller severity), f: 10Hz to 500Hz.Three directions, 2h for each direction, total 6h.
	Bump(straight lead)	There shall be no evidence of deterioration.	4 000 times, Acceleration: 390m/s ² ,Pulse duration, 6ms
	Final measurement	ΔC/C ≤±5%(relative to the initial value) Increase of tgδ: ≤0.003 (C≤1.0μF) ≤0.002 (C>1.0μF) IR: ≥ 50% of the rated value	
4	climate sequence	Initial measurement	Capacitance, Tgδ
		Dry heat	+105°C, 16h
		Damp heat, Cyclic	Test Db, Severity: b, the first cycle
		Cold	-55°C, 2h
		Low air pressure	There shall be no permanent breakdown,flashover or other harmful deformation when applying U _R at the last 1 minute. 15°C~ 35°C, 8.5kPa, 1h,
		Damp heat, cyclic other	Test Db, Severity b, the other cycles, Applying U _R for 1 minute after the test finished.

No.	Item		Performance	Test method (GB 7332(IEC 60384-2))
4	climate sequence (continue)	Final measurement	<p>There shall be no evidence of deterioration and the marking shall be legible.</p> <p>$\Delta C/C \leq \pm 5\%$ (relative to the initial value)</p> <p>Increase of $\text{tg}\delta$:</p> <p>≤ 0.005 ($C \leq 1.0\mu\text{F}$)</p> <p>≤ 0.003 ($C > 1.0\mu\text{F}$)</p> <p>IR: $\geq 50\%$ of the rated value</p>	
5	Damp heat steady state		<p>There shall be no evidence of deterioration and the marking shall be legible.</p> <p>$\Delta C/C \leq \pm 5\%$ (relative to the initial value)</p> <p>Increase of $\text{tg}\delta \leq 0.005$</p> <p>IR: $\geq 50\%$ of the rated value</p>	<p>Temperature: $40^\circ\text{C} \pm 2^\circ\text{C}$</p> <p>Humidity: $93 \pm 2\%$ RH</p> <p>Duration: 56days</p>
6	Endurance		<p>There shall be no evidence of deterioration and the marking shall be legible.</p> <p>$\Delta C/C \leq \pm 5\%$ (relative to the initial value)</p> <p>Increase of $\text{tg}\delta$:</p> <p>≤ 0.003 ($C \leq 1.0\mu\text{F}$)</p> <p>≤ 0.002 ($C > 1.0\mu\text{F}$)</p> <p>IR: $\geq 50\%$ of the rated value</p>	<p>Temperature: $+85^\circ\text{C}/+100^\circ\text{C}$</p> <p>Voltage: $1.25 \times U_R / 1.25 \times U_c$ ($U_c = 0.8U_R$)</p> <p>Duration: 2 000h</p>
7	Temperature characteristic		<p>Measuring capacitance at test point b, d, f:</p> <p>Characteristic at lower category temperature -55°C:</p> <p>$-10\% \leq (C_b - C_d)/C_d \leq 0\%$</p> <p>Characteristic at upper category temperature $+100^\circ\text{C}$:</p> <p>$0\% \leq (C_f - C_d)/C_d \leq +10\%$</p> <p>I.R. (test at point f):</p> <p>$U_R \leq 100\text{V}$: $\geq 75 \text{ M}\Omega$ ($C \leq 0.33\mu\text{F}$)</p> <p>$\geq 25\text{s}$ ($C > 0.33\mu\text{F}$)</p> <p>$U_R > 100\text{V}$: $\geq 150 \text{ M}\Omega$ ($C \leq 0.33\mu\text{F}$)</p> <p>$\geq 50\text{s}$ ($C > 0.33\mu\text{F}$)</p>	<p>Static method: The Capacitors should be kept at the following temperature in turn:</p> <p>a(20 ± 2) $^\circ\text{C}$, b(-55 ± 3) $^\circ\text{C}$, d(20 ± 2) $^\circ\text{C}$, f(100 ± 2) $^\circ\text{C}$, g(20 ± 2) $^\circ\text{C}$</p>
8	Charging and discharging		<p>$\Delta C/C \leq \pm 5\%$ (relative to the initial value)</p> <p>Increase of $\text{tg}\delta$:</p> <p>≤ 0.003 ($C \leq 1.0\mu\text{F}$)</p> <p>≤ 0.002 ($C > 1.0\mu\text{F}$)</p> <p>IR: $\geq 50\%$ of the rated value</p>	<p>Times: 10 000</p> <p>Duration of charging: 0.5s</p> <p>Duration of discharging: 0.5s</p> <p>Charging voltage: rated voltage</p> <p>Charging resistance: $220/C_N(\Omega)$</p> <p>Discharging resistance:</p> <p>$R = 10/C_N(\Omega)$ or 20Ω (whichever is the greater)</p> <p>C_N: rated capacitance (μF)</p>

- **Marking:**
For example:

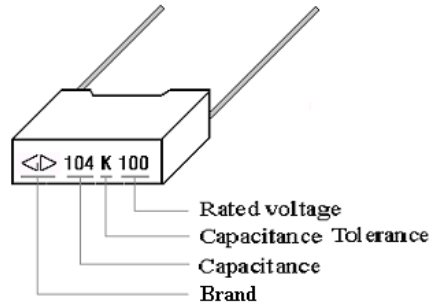

■ Taping specification for box-type capacitors

▲ Outline Drawing

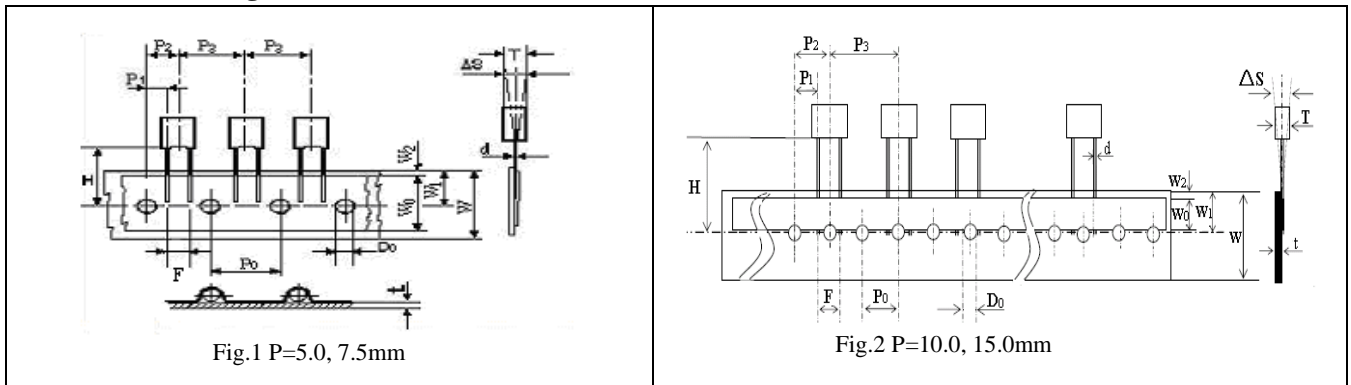

▲ Taping Dimensions(mm)

Technology index title	Code	Dimensions				Tolerance
		P=5.0	P=7.5	P=10.0	P=15.0	
Taping type	—	Fig 1	Fig 1	Fig2	Fig 2	—
Part number Digit12-15	Ammo-pack	A201	A301	A405	A605	
Taping pitch	P ₃	12.7	12.7	25.4	25.4	±1.0
Feed hole pitch	P ₀	12.7	12.7	12.7	12.7	±0.3
Center of wire	P ₁	3.85	2.6	7.7	5.2	±0.7
Center of body	P ₂	6.35	6.35	12.7	12.7	±1.3
Pitch of taping wire	F**	5.0	7.5	10.0	15.0	+0.6 -0.1
Component alignment	△S	0	0	0	0	±2.0
Height of component from tape center	H***	18.5	18.5	18.5	18.5	±0.5
Carrier tape width	W	18.0	18.0	18.0	18.0	+1.0 -0.5
Hold down tape width	W ₀	6min	10min	10min	10min	—
Hole position	W ₁	9.0	9.0	9.0	9.0	±0.5
Hold down tape position	W ₂	3max	3max	3max	3max	—
Feed hole dia.	D ₀	4.0	4.0	4.0	4.0	±0.2
Tape thickness	t	0.7	0.7	0.7	0.7	±0.2

Note: * P₀=15mm is also available;
 **F can be other lead spacing;
 ***H=16.5mm is available;

■ Packing box sizes(mm)(example)

1. Out packing box for bulk

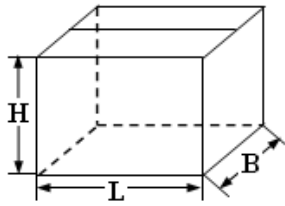

L:375±5
B:375±5
H:265±5

2. Inner packing box for bulk

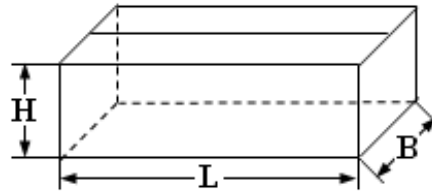

L:355±3
B:175±3
H:118±3

3. Box sizes for Ammo-pack

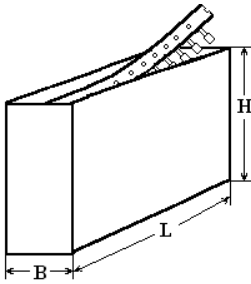

L:350±3
B:50±3
H:260±3

X-ON Electronics

Largest Supplier of Electrical and Electronic Components

Click to view similar products for [Film Capacitors](#) category:

Click to view products by [FARATRONIC](#) manufacturer:

Other Similar products are found below :

[703-6G](#) [82DC4100CK60J](#) [82EC1100DQ50K](#) [MMWAF150KME](#) [PCY2130F30153](#) [QXJ2E474KTPT](#) [QXL2B333KTPT](#) [QXM2G104K](#)
[DPM16S56K-1F](#) [EEC2G505HQA406](#) [B32234-.033@250V-K](#) [B81133-C1104-M3](#) [MTC355L1](#) [217-0716-001](#) [PA225L30](#) [CB182K0184J--](#)
[KP1830-247/061-G](#) [274ACF4400WA0J](#) [274ACF5150WA0J](#) [SCD105K122A3-22](#) [SCD205K122A3-24](#) [PCX2339F65224](#) [PCX2339F65334](#)
[2222 368 55105](#) [2222 370 21683](#) [QXL2E473KTPT](#) [445450-1](#) [MKT182022263473](#) [WMC08P22](#) [46KN410000N1K](#) [46KR368050M1M](#) [ECQ-](#)
[W4223KZ](#) [EEC2G805HQA415](#) [PA103L30](#) [82DC4100AA60K](#) [82EC2150DQ50K](#) [VEA105K50](#) [82IC2150DQ50J](#) [82EC2220DQ50J](#)
[MTC55L4](#) [MTC56L4](#) [730P205X9400](#) [PA104L30](#) [PA224L30](#) [82DC3220AA60J](#) [82EC4100DQ70J](#) [WYP-104M](#) [82CC4220AA70J](#)
[82EC3100Z370J](#) [B32656S8105K566](#)