

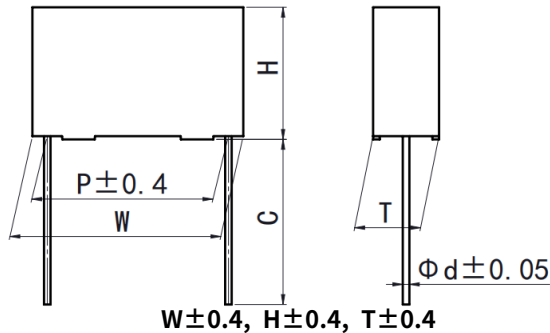

金属化聚丙烯膜电容器 Metallized polypropylene film capacitor(Box-type)

外形图 Outline Drawing



特点

- 金属化聚丙烯膜
- 高频损耗小
- 内部温升小
- 塑料外壳 (UL94 V-0), 阻燃环氧填充

主要用途

- 广泛应用于高频、直流、交流和脉冲电路中
- 电视机、显示器 S 校正电路

Features

- Metallized polypropylene film
- Low loss at high frequency
- Small inherent temperature rise
- Plastic case(UL94 V-0), epoxy resin sealing

Typical Applications

- Widely used in high frequency, DC, AC and pulse circuits
- S-correction circuits for TV sets and monitors

技术要求 Specifications

引用标准 Reference Standard	GB/T 10190 (IEC 60384-16)						
气候类别 Climatic Category	55/105/56						
额定温度 Rated Temperature	85°C						
工作温度 Operating Temperature Range	-55°C~105°C (+85°C to +105°C: decreasing factor 1.25% per °C for U _R)						
额定电压 Rated Voltage	160Vdc(90Vac), 250Vdc(160Vac), 400Vdc(220Vac), 630Vdc(250Vac) 1 000Vdc(400Vac), 1 600Vdc(600Vac), 2 000Vdc(700Vac)						
电容量范围 Capacitance Range	0.00056μF~15.0μF						
电容量偏差 Capacitance Tolerance	±2%(G), ±3%(H), ±5%(J), ±10%(K), ±20%(M)						
耐电压 Voltage Proof	1.6U _R (5s)						
损耗角正切 Dissipation Factor	≤10×10 ⁻⁴ (20°C, 1kHz)						
绝缘电阻 Insulation Resistance	R≥100 000MΩ, C _N ≤0.33μF RC _N ≥30 000s, C _N >0.33μF (20°C, 100V, 1min)						
最大脉冲爬升速率 Maximum Pulse Rise Time(dV/dt):若实际工作电压 U 比额定电压 U _R 低, 电容器可工作在更高的 dV/dt 场合, 这样 dV/dt 允许值应为右表值乘以 U _R /U。 If the working voltage(U) is lower than the rated voltage(U _R),the capacitor can be worked at a higher dV/dt. In this case, the maximum allowed dV/dt is obtain by multiplying the right value with U _R /U.	U _R (V)	dV/dt(V/μs)					
		P=5.0	P=7.5	P=10.0	P=15.0	P=22.5	P=27.5
	160	110	310	190	110	65	55
	250	270	660	560	310	130	110
	400	440	900	780	600	300	130
	630	550	1500	1200	900	400	200
	1 000	-	-	2200	2 000	800	-
	1 600	-	-	-	4 500	1 800	-
2 000	-	-	-	9 500	4 500	-	

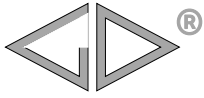

C32

MKP21 series

■ 产品编码说明 Part number system

■ 15 位产品代码如下:

The 15 digits part number is formed as follow:

1	2	3	4	5	6	7	8	9	10	11	12	13	14	15
C	3	2												

第 1~3 位	型号代码	Digit 1 to 3	Series code
	C32= MKP21		C32= MKP21
第 4~5 位	直流额定电压	Digit 4 to 5	D.C. rated voltage
	2C=160V 2E=250V 2G=400V 2J=630V 3A=1000V 3C=1600V 3D=2 000V		2C=160V 2E=250V 2G=400V 2J=630V 3A=1000V 3C=1600V 3D=2 000V
第 6~8 位	标称容量	Digit 6 to 8	Rated capacitance value
	举例: 103=10×10 ³ pF=0.01μF		for example: 103=10×10 ³ pF=0.01μF
第 9 位	容量偏差	Digit 9	Capacitance tolerance
	G=±2%, H=±3%, J=±5% K=±10%, M=±20%		G=±2%, H=±3%, J=±5% K=±10%, M=±20%
第 10 位	引线脚距 P	Digit 10	Pitch
	2=5.0mm 3=7.5mm 4=10.0mm 6=15.0mm 9=22.5mm B=27.5mm		2=5.0mm 3=7.5mm 4=10.0mm 6=15.0mm 9=22.5mm B=27.5mm
第 11 位	内部特征码	Digit 11	Internal use
第 12~15 位	引线加工和包装代码	Digit 12 to 15	Lead form and packaging code

■ Table 1 引线加工和包装代码 lead form and packaging code

第 12 位 Digit 12		第 13 位 Digit 13		第 14 位 Digit 14		第 15 位 Digit 15	
代码 Code	说明 explanation	代码 Code	说明 explanation	代码 Code	说明 explanation	代码 Code	说明 explanation
A	弹带包装 ammo-pack	2	F=5.0mm	0	表示直脚 straight	1	产品在连续的两个载带孔之间 each cap.among two consecutive holes P3=12.7mm, H=18.5mm(For pitch=5.0/7.5mm)
		3	F=7.5mm				5
		4	F=10.0mm				
		6	F=15.0mm				
C	直脚 straight lead “C” in the figure above	代码 Code	说明 explanation	0			引线长度偏差±0.5mm 或标准长度 Length tolerance±0.5mm Or standard length
		00	标准的引线长度(18mm ~26 mm) standard lead length				
		45	引线长度 4.5mm lead length 4.5mm				

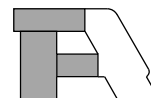

■ 外形尺寸 Dimensions(mm)

160V(90Vac)						
C _N (μF)	W	H	T	P	d	Part number
0.027	7.2	7.5	3.5	5.0	0.5	C322C273-20****
0.033	7.2	7.5	3.5	5.0	0.5	C322C333-20****
0.039	7.2	7.5	3.5	5.0	0.5	C322C393-20****
0.047	7.2	9.5	4.5	5.0	0.6	C322C473-20****
0.056	7.2	9.5	4.5	5.0	0.6	C322C563-20****
0.068	7.2	9.5	4.5	5.0	0.6	C322C683-20****
0.082	7.2	10.0	5.0	5.0	0.6	C322C823-20****
0.10	7.2	10.0	5.0	5.0	0.6	C322C104-20****
0.12	7.2	11.0	6.0	5.0	0.6	C322C124-20****
0.15	7.2	11.0	6.0	5.0	0.6	C322C154-20****
0.068	10.5	9.0	4.0	7.5	0.6	C322C683-30****
0.082	10.5	9.0	4.0	7.5	0.6	C322C823-30****
0.10	10.5	11.0	5.0	7.5	0.6	C322C104-30****
0.12	10.5	11.0	5.0	7.5	0.6	C322C124-30****
0.15	10.5	12.0	6.0	7.5	0.6	C322C154-30****
0.18	10.5	12.0	6.0	7.5	0.6	C322C184-30****
0.082	13.0	9.0	4.0	10.0	0.6	C322C823-40****
0.10	13.0	9.0	4.0	10.0	0.6	C322C104-40****
0.12	13.0	11.0	5.0	10.0	0.6	C322C124-40****
0.15	13.0	11.0	5.0	10.0	0.6	C322C154-40****
0.18	13.0	11.0	5.0	10.0	0.6	C322C184-40****
0.22	13.0	12.0	6.0	10.0	0.6	C322C224-40****
0.27	13.0	12.0	6.0	10.0	0.6	C322C274-40****
0.18	17.5	11.0	5.0	15.0	0.8	C322C184-60****
0.22	17.5	11.0	5.0	15.0	0.8	C322C224-60****
0.27	17.5	11.0	5.0	15.0	0.8	C322C274-60****
0.33	17.5	11.0	5.0	15.0	0.8	C322C334-60****
0.39	17.5	12.0	6.0	15.0	0.8	C322C394-60****
0.47	17.5	12.0	6.0	15.0	0.8	C322C474-60****
0.56	17.5	13.5	7.5	15.0	0.8	C322C564-60****
0.68	17.5	13.5	7.5	15.0	0.8	C322C684-60****

160V(90Vac)						
C _N (μF)	W	H	T	P	d	Part number
0.82	17.5	14.5	8.5	15.0	0.8	C322C824-60****
1.0	17.5	16.0	10.0	15.0	0.8	C322C105-60****
1.2	17.5	16.0	10.0	15.0	0.8	C322C125-60****
1.5	17.5	19.0	11.0	15.0	0.8	C322C155-60****
1.8	17.5	19.0	11.0	15.0	0.8	C322C185-60****
0.47	26.5	15.0	6.0	22.5	0.8	C322C474-90****
0.56	26.5	15.0	6.0	22.5	0.8	C322C564-90****
0.68	26.5	15.0	6.0	22.5	0.8	C322C684-90****
0.82	26.5	16.0	7.0	22.5	0.8	C322C824-90****
1.0	26.5	16.0	7.0	22.5	0.8	C322C105-90****
1.2	26.5	17.0	8.5	22.5	0.8	C322C125-90****
1.5	26.5	17.0	8.5	22.5	0.8	C322C155-90****
1.8	26.5	18.5	10.0	22.5	0.8	C322C185-90****
2.2	26.5	20.0	11.0	22.5	0.8	C322C225-90****
2.7	26.5	22.0	12.0	22.5	0.8	C322C275-90****
3.3	26.5	22.0	12.0	22.5	0.8	C322C335-90****
1.0	32.0	18.0	9.0	27.5	0.8	C322C105-B0****
1.2	32.0	18.0	9.0	27.5	0.8	C322C125-B0****
1.5	32.0	18.0	9.0	27.5	0.8	C322C155-B0****
1.8	32.0	18.0	9.0	27.5	0.8	C322C185-B0****
2.2	32.0	18.0	9.0	27.5	0.8	C322C225-B0****
2.7	32.0	20.0	11.0	27.5	0.8	C322C275-B0****
3.3	32.0	20.0	11.0	27.5	0.8	C322C335-B0****
3.9	32.0	22.0	13.0	27.5	0.8	C322C395-B0****
4.7	32.0	28.0	14.0	27.5	0.8	C322C475-B0****
5.6	32.0	24.5	15.0	27.5	0.8	C322C565-B0****
6.8	32.0	33.0	18.0	27.5	0.8	C322C685-B0****
8.2	32.0	33.0	18.0	27.5	0.8	C322C825-B0****
10.0	32.0	33.0	18.0	27.5	0.8	C322C106-B0****
12.0	32.0	37.0	22.0	27.5	0.8	C322C126-B0****
15.0	32.0	37.0	22.0	27.5	0.8	C322C156-B0****

备注 Note: 1. “-”表示容量偏差。 “-”=capacitance tolerance code. M=±20%, K=±10%, J=±5%, H=±3%, G=±2%.
2. “****”表示引线加工和包装代码(见表1)。“****”=lead form and packing code (refer to table 1).

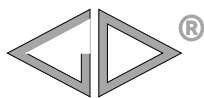

C32

MKP21 series

■ 外形尺寸 Dimensions(mm)

250V(160Vac)						
C _N (μF)	W	H	T	P	d	Part number
0.012	7.2	7.5	3.5	5.0	0.5	C322E123-20****
0.015	7.2	7.5	3.5	5.0	0.5	C322E153-20****
0.018	7.2	7.5	3.5	5.0	0.5	C322E183-20****
0.022	7.2	7.5	3.5	5.0	0.5	C322E223-20****
0.027	7.2	7.5	3.5	5.0	0.5	C322E273-20****
0.033	7.2	7.5	3.5	5.0	0.5	C322E333-20****
0.039	7.2	7.5	3.5	5.0	0.5	C322E393-20****
0.047	7.2	9.5	4.5	5.0	0.6	C322E473-20****
0.056	7.2	9.5	4.5	5.0	0.6	C322E563-20****
0.068	7.2	10.0	5.0	5.0	0.6	C322E683-20****
0.082	7.2	10.0	5.0	5.0	0.6	C322E823-20****
0.10	7.2	11.0	6.0	5.0	0.6	C322E104-20****
0.12	7.2	11.0	6.0	5.0	0.6	C322E124-20****
0.027	10.5	9.0	4.0	7.5	0.6	C322E273-30****
0.033	10.5	9.0	4.0	7.5	0.6	C322E333-30****
0.039	10.5	9.0	4.0	7.5	0.6	C322E393-30****
0.047	10.5	9.0	4.0	7.5	0.6	C322E473-30****
0.056	10.5	9.0	4.0	7.5	0.6	C322E563-30****
0.068	10.5	9.0	4.0	7.5	0.6	C322E683-30****
0.082	10.5	11.0	5.0	7.5	0.6	C322E823-30****
0.10	10.5	11.0	5.0	7.5	0.6	C322E104-30****
0.12	10.5	11.0	5.0	7.5	0.6	C322E124-30****
0.15	10.5	12.0	6.0	7.5	0.6	C322E154-30****
0.18	10.5	12.0	6.0	7.5	0.6	C322E184-30****
0.033	13.0	9.0	4.0	10.0	0.6	C322E333-40****
0.039	13.0	9.0	4.0	10.0	0.6	C322E393-40****
0.047	13.0	9.0	4.0	10.0	0.6	C322E473-40****
0.056	13.0	9.0	4.0	10.0	0.6	C322E563-40****
0.068	13.0	9.0	4.0	10.0	0.6	C322E683-40****
0.082	13.0	9.0	4.0	10.0	0.6	C322E823-40****
0.10	13.0	11.0	5.0	10.0	0.6	C322E104-40****
0.12	13.0	11.0	5.0	10.0	0.6	C322E124-40****
0.15	13.0	11.0	5.0	10.0	0.6	C322E154-40****
0.18	13.0	12.0	6.0	10.0	0.6	C322E184-40****
0.22	13.0	12.0	6.0	10.0	0.6	C322E224-40****
0.10	17.5	11.0	5.0	15.0	0.8	C322E104-60****
0.12	17.5	11.0	5.0	15.0	0.8	C322E124-60****
0.15	17.5	11.0	5.0	15.0	0.8	C322E154-60****

250V(160Vac)						
C _N (μF)	W	H	T	P	d	Part number
0.18	17.5	11.0	5.0	15.0	0.8	C322E184-60****
0.22	17.5	11.0	5.0	15.0	0.8	C322E224-60****
0.27	17.5	12.0	6.0	15.0	0.8	C322E274-60****
0.33	17.5	12.0	6.0	15.0	0.8	C322E334-60****
0.39	17.5	13.5	7.5	15.0	0.8	C322E394-60****
0.47	17.5	13.5	7.5	15.0	0.8	C322E474-60****
0.56	17.5	13.5	7.5	15.0	0.8	C322E564-60****
0.68	17.5	14.5	8.5	15.0	0.8	C322E684-60****
0.82	17.5	16.0	10.0	15.0	0.8	C322E824-60****
1.0	17.5	16.0	10.0	15.0	0.8	C322E105-60****
1.2	17.5	19.0	11.0	15.0	0.8	C322E125-60****
0.39	26.5	15.0	6.0	22.5	0.8	C322E394-90****
0.47	26.5	15.0	6.0	22.5	0.8	C322E474-90****
0.56	26.5	15.0	6.0	22.5	0.8	C322E564-90****
0.68	26.5	15.0	6.0	22.5	0.8	C322E684-90****
0.82	26.5	15.0	6.0	22.5	0.8	C322E824-90****
1.0	26.5	16.0	7.0	22.5	0.8	C322E105-90****
1.2	26.5	17.0	8.5	22.5	0.8	C322E125-90****
1.5	26.5	17.0	8.5	22.5	0.8	C322E155-90****
1.8	26.5	18.5	10.0	22.5	0.8	C322E185-90****
2.2	26.5	20.0	11.0	22.5	0.8	C322E225-90****
2.7	26.5	22.0	12.0	22.5	0.8	C322E275-90****
0.82	32.0	18.0	9.0	27.5	0.8	C322E824-B0****
1.0	32.0	18.0	9.0	27.5	0.8	C322E105-B0****
1.2	32.0	18.0	9.0	27.5	0.8	C322E125-B0****
1.5	32.0	18.0	9.0	27.5	0.8	C322E155-B0****
1.8	32.0	18.0	9.0	27.5	0.8	C322E185-B0****
2.2	32.0	18.0	9.0	27.5	0.8	C322E225-B0****
2.7	32.0	20.0	11.0	27.5	0.8	C322E275-B0****
3.3	32.0	20.0	11.0	27.5	0.8	C322E335-B0****
3.9	32.0	22.0	13.0	27.5	0.8	C322E395-B0****
4.7	32.0	28.0	14.0	27.5	0.8	C322E475-B0****
5.6	32.0	24.5	15.0	27.5	0.8	C322E565-B0****
6.8	32.0	33.0	18.0	27.5	0.8	C322E685-B0****
8.2	32.0	33.0	18.0	27.5	0.8	C322E825-B0****
10.0	32.0	33.0	18.0	27.5	0.8	C322E106-B0****
12.0	32.0	37.0	22.0	27.5	0.8	C322E126-B0****
15.0	32.0	37.0	22.0	27.5	0.8	C322E156-B0****

备注 Note: 1. “-”表示容量偏差。 “-”=capacitance tolerance code. M=±20%, K=±10%, J=±5%, H=±3%, G=±2%。
 2. “****”表示引线加工和包装代码(见表1)。“****”=lead form and packing code (refer to table 1).

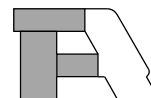

■ 外形尺寸 Dimensions(mm)

400V(220Vac) [@]						
C _N (μF)	W	H	T	P	d	Part number
0.0039	7.2	7.5	3.5	5.0	0.5	C322G392-20****
0.0047	7.2	7.5	3.5	5.0	0.5	C322G472-20****
0.0056	7.2	7.5	3.5	5.0	0.5	C322G562-20****
0.0068	7.2	7.5	3.5	5.0	0.5	C322G682-20****
0.0082	7.2	7.5	3.5	5.0	0.5	C322G822-20****
0.010	7.2	7.5	3.5	5.0	0.5	C322G103-20****
0.012	7.2	7.5	3.5	5.0	0.5	C322G123-20****
0.015	7.2	9.5	4.5	5.0	0.6	C322G153-20****
0.018	7.2	9.5	4.5	5.0	0.6	C322G183-20****
0.022	7.2	9.5	4.5	5.0	0.6	C322G223-20****
0.027	7.2	10.0	5.0	5.0	0.6	C322G273-20****
0.033	7.2	11.0	6.0	5.0	0.6	C322G333-20****
0.039	7.2	11.0	6.0	5.0	0.6	C322G393-20****
0.047	7.2	11.0	6.0	5.0	0.6	C322G473-20****
0.010	10.5	9.0	4.0	7.5	0.6	C322G103-30****
0.012	10.5	9.0	4.0	7.5	0.6	C322G123-30****
0.015	10.5	9.0	4.0	7.5	0.6	C322G153-30****
0.018	10.5	9.0	4.0	7.5	0.6	C322G183-30****
0.022	10.5	9.0	4.0	7.5	0.6	C322G223-30****
0.027	10.5	9.0	4.0	7.5	0.6	C322G273-30****
0.033	10.5	11.0	5.0	7.5	0.6	C322G333-30****
0.039	10.5	11.0	5.0	7.5	0.6	C322G393-30****
0.047	10.5	11.0	5.0	7.5	0.6	C322G473-30****
0.056	10.5	12.0	6.0	7.5	0.6	C322G563-30****
0.068	10.5	12.0	6.0	7.5	0.6	C322G683-30****
0.015	13.0	9.0	4.0	10.0	0.6	C322G153-40****
0.018	13.0	9.0	4.0	10.0	0.6	C322G183-40****
0.022	13.0	9.0	4.0	10.0	0.6	C322G223-40****
0.027	13.0	9.0	4.0	10.0	0.6	C322G273-40****
0.033	13.0	9.0	4.0	10.0	0.6	C322G333-40****
0.039	13.0	9.0	4.0	10.0	0.6	C322G393-40****
0.047	13.0	11.0	5.0	10.0	0.6	C322G473-40****
0.056	13.0	11.0	5.0	10.0	0.6	C322G563-40****
0.068	13.0	11.0	5.0	10.0	0.6	C322G683-40****
0.082	13.0	12.0	6.0	10.0	0.6	C322G823-40****
0.10	13.0	12.0	6.0	10.0	0.6	C322G104-40****
0.068	17.5	11.0	5.0	15.0	0.8	C322G683-60****

400V(220Vac) [@]						
C _N (μF)	W	H	T	P	d	Part number
0.082	17.5	11.0	5.0	15.0	0.8	C322G823-60****
0.10	17.5	11.0	5.0	15.0	0.8	C322G104-60****
0.12	17.5	11.0	5.0	15.0	0.8	C322G124-60****
0.15	17.5	12.0	6.0	15.0	0.8	C322G154-60****
0.18	17.5	12.0	6.0	15.0	0.8	C322G184-60****
0.22	17.5	13.5	7.5	15.0	0.8	C322G224-60****
0.27	17.5	13.5	7.5	15.0	0.8	C322G274-60****
0.33	17.5	14.5	8.5	15.0	0.8	C322G334-60****
0.39	17.5	16.0	10.0	15.0	0.8	C322G394-60****
0.47	17.5	16.0	10.0	15.0	0.8	C322G474-60****
0.56	17.5	19.0	11.0	15.0	0.8	C322G564-60****
0.68	17.5	19.0	11.0	15.0	0.8	C322G684-60****
0.18	26.5	15.0	6.0	22.5	0.8	C322G184-90****
0.22	26.5	15.0	6.0	22.5	0.8	C322G224-90****
0.27	26.5	15.0	6.0	22.5	0.8	C322G274-90****
0.33	26.5	15.0	6.0	22.5	0.8	C322G334-90****
0.39	26.5	16.0	7.0	22.5	0.8	C322G394-90****
0.47	26.5	16.0	7.0	22.5	0.8	C322G474-90****
0.56	26.5	17.0	8.5	22.5	0.8	C322G564-90****
0.68	26.5	17.0	8.5	22.5	0.8	C322G684-90****
0.82	26.5	18.5	10.0	22.5	0.8	C322G824-90****
1.0	26.5	20.0	11.0	22.5	0.8	C322G105-90****
1.2	26.5	22.0	12.0	22.5	0.8	C322G125-90****
1.5	26.5	22.0	12.0	22.5	0.8	C322G155-90****
0.56	32.0	18.0	9.0	27.5	0.8	C322G564-B0****
0.68	32.0	18.0	9.0	27.5	0.8	C322G684-B0****
0.82	32.0	18.0	9.0	27.5	0.8	C322G824-B0****
1.0	32.0	18.0	9.0	27.5	0.8	C322G105-B0****
1.2	32.0	20.0	11.0	27.5	0.8	C322G125-B0****
1.5	32.0	20.0	11.0	27.5	0.8	C322G155-B0****
1.8	32.0	22.0	13.0	27.5	0.8	C322G185-B0****
2.2	32.0	24.5	15.0	27.5	0.8	C322G225-B0****
2.7	32.0	28.0	14.0	27.5	0.8	C322G275-B0****
3.3	32.0	33.0	18.0	27.5	0.8	C322G335-B0****
3.9	32.0	33.0	18.0	27.5	0.8	C322G395-B0****
4.7	32.0	37.0	22.0	27.5	0.8	C322G475-B0****
5.6	32.0	37.0	22.0	27.5	0.8	C322G565-B0****

备注 Note: 1. “-”表示容量偏差。 “-”=capacitance tolerance code. M=±20%, K=±10%, J=±5%, H=±3%, G=±2%。
 2. “****”表示引线加工和包装代码(见表1)。“****”=lead form and packing code (refer to table 1).
 3. “@”不用作跨线,请参见抗干扰电容器(Page 109)。
 “@” Not suitable for across-the-line application. Pls refer to Interference Suppression Capacitors(Page 109).

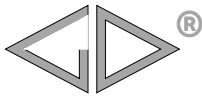

■ 外形尺寸 Dimensions(mm)

630V(250Vac) [®]							630V(250Vac) [®]							630V(250Vac) [®]						
C _N (μF)	W	H	T	P	d	Part number	C _N (μF)	W	H	T	P	d	Part number	C _N (μF)	W	H	T	P	d	Part number
0.0010	7.2	7.5	3.5	5.0	0.5	C322J102-20****	0.027	10.5	12.0	6.0	7.5	0.6	C322J273-30****	0.12	17.5	13.5	7.5	15.0	0.8	C322J124-60****
0.0012	7.2	7.5	3.5	5.0	0.5	C322J122-20****	0.033	10.5	12.0	6.0	7.5	0.6	C322J333-30****	0.15	17.5	13.5	7.5	15.0	0.8	C322J154-60****
0.0015	7.2	7.5	3.5	5.0	0.5	C322J152-20****	0.0010	13.0	9.0	4.0	10.0	0.6	C322J102-40****	0.18	17.5	14.5	8.5	15.0	0.8	C322J184-60****
0.0018	7.2	7.5	3.5	5.0	0.5	C322J182-20****	0.0012	13.0	9.0	4.0	10.0	0.6	C322J122-40****	0.22	17.5	16.0	10.0	15.0	0.8	C322J224-60****
0.0022	7.2	7.5	3.5	5.0	0.5	C322J222-20****	0.0015	13.0	9.0	4.0	10.0	0.6	C322J152-40****	0.27	17.5	19.0	11.0	15.0	0.8	C322J274-60****
0.0027	7.2	7.5	3.5	5.0	0.5	C322J272-20****	0.0018	13.0	9.0	4.0	10.0	0.6	C322J182-40****	0.33	17.5	19.0	11.0	15.0	0.8	C322J334-60****
0.0033	7.2	7.5	3.5	5.0	0.5	C322J332-20****	0.0022	13.0	9.0	4.0	10.0	0.6	C322J222-40****	0.082	26.5	15.0	6.0	22.5	0.8	C322J823-90****
0.0039	7.2	9.5	4.5	5.0	0.6	C322J392-20****	0.0027	13.0	9.0	4.0	10.0	0.6	C322J272-40****	0.10	26.5	15.0	6.0	22.5	0.8	C322J104-90****
0.0047	7.2	9.5	4.5	5.0	0.6	C322J472-20****	0.0033	13.0	9.0	4.0	10.0	0.6	C322J332-40****	0.12	26.5	15.0	6.0	22.5	0.8	C322J124-90****
0.0056	7.2	10.0	5.0	5.0	0.6	C322J562-20****	0.0039	13.0	9.0	4.0	10.0	0.6	C322J392-40****	0.15	26.5	15.0	6.0	22.5	0.8	C322J154-90****
0.0068	7.2	10.0	5.0	5.0	0.6	C322J682-20****	0.0047	13.0	9.0	4.0	10.0	0.6	C322J472-40****	0.18	26.5	15.0	6.0	22.5	0.8	C322J184-90****
0.0082	7.2	11.0	6.0	5.0	0.6	C322J822-20****	0.0056	13.0	9.0	4.0	10.0	0.6	C322J562-40****	0.22	26.5	16.0	7.0	22.5	0.8	C322J224-90****
0.010	7.2	11.0	6.0	5.0	0.6	C322J103-20****	0.0068	13.0	9.0	4.0	10.0	0.6	C322J682-40****	0.27	26.5	17.0	8.5	22.5	0.8	C322J274-90****
0.012	7.2	11.0	6.0	5.0	0.6	C322J123-20****	0.0082	13.0	9.0	4.0	10.0	0.6	C322J822-40****	0.33	26.5	17.0	8.5	22.5	0.8	C322J334-90****
0.0010	10.5	9.0	4.0	7.5	0.6	C322J102-30****	0.010	13.0	9.0	4.0	10.0	0.6	C322J103-40****	0.39	26.5	18.5	10.0	22.5	0.8	C322J394-90****
0.0012	10.5	9.0	4.0	7.5	0.6	C322J122-30****	0.012	13.0	9.0	4.0	10.0	0.6	C322J123-40****	0.47	26.5	18.5	10.0	22.5	0.8	C322J474-90****
0.0015	10.5	9.0	4.0	7.5	0.6	C322J152-30****	0.015	13.0	9.0	4.0	10.0	0.6	C322J153-40****	0.56	26.5	20.0	11.0	22.5	0.8	C322J564-90****
0.0018	10.5	9.0	4.0	7.5	0.6	C322J182-30****	0.018	13.0	9.0	4.0	10.0	0.6	C322J183-40****	0.68	26.5	22.0	12.0	22.5	0.8	C322J684-90****
0.0022	10.5	9.0	4.0	7.5	0.6	C322J222-30****	0.022	13.0	11.0	5.0	10.0	0.6	C322J223-40****	0.33	32.0	18.0	9.0	27.5	0.8	C322J334-B0****
0.0027	10.5	9.0	4.0	7.5	0.6	C322J272-30****	0.027	13.0	11.0	5.0	10.0	0.6	C322J273-40****	0.39	32.0	18.0	9.0	27.5	0.8	C322J394-B0****
0.0033	10.5	9.0	4.0	7.5	0.6	C322J332-30****	0.033	13.0	11.0	5.0	10.0	0.6	C322J333-40****	0.47	32.0	18.0	9.0	27.5	0.8	C322J474-B0****
0.0039	10.5	9.0	4.0	7.5	0.6	C322J392-30****	0.039	13.0	12.0	6.0	10.0	0.6	C322J393-40****	0.56	32.0	20.0	11.0	27.5	0.8	C322J564-B0****
0.0047	10.5	9.0	4.0	7.5	0.6	C322J472-30****	0.047	13.0	12.0	6.0	10.0	0.6	C322J473-40****	0.68	32.0	20.0	11.0	27.5	0.8	C322J684-B0****
0.0056	10.5	9.0	4.0	7.5	0.6	C322J562-30****	0.027	17.5	11.0	5.0	15.0	0.8	C322J273-60****	0.82	32.0	20.0	11.0	27.5	0.8	C322J824-B0****
0.0068	10.5	9.0	4.0	7.5	0.6	C322J682-30****	0.033	17.5	11.0	5.0	15.0	0.8	C322J333-60****	1.0	32.0	22.0	13.0	27.5	0.8	C322J105-B0****
0.0082	10.5	9.0	4.0	7.5	0.6	C322J822-30****	0.039	17.5	11.0	5.0	15.0	0.8	C322J393-60****	1.2	32.0	24.5	15.0	27.5	0.8	C322J125-B0****
0.010	10.5	9.0	4.0	7.5	0.6	C322J103-30****	0.047	17.5	11.0	5.0	15.0	0.8	C322J473-60****	1.5	32.0	28.0	14.0	27.5	0.8	C322J155-B0****
0.012	10.5	9.0	4.0	7.5	0.6	C322J123-30****	0.056	17.5	11.0	5.0	15.0	0.8	C322J563-60****	1.8	32.0	33.0	18.0	27.5	0.8	C322J185-B0****
0.015	10.5	11.0	5.0	7.5	0.6	C322J153-30****	0.068	17.5	12.0	6.0	15.0	0.8	C322J683-60****	2.2	32.0	33.0	18.0	27.5	0.8	C322J225-B0****
0.018	10.5	11.0	5.0	7.5	0.6	C322J183-30****	0.082	17.5	12.0	6.0	15.0	0.8	C322J823-60****	2.7	32.0	37.0	22.0	27.5	0.8	C322J275-B0****
0.022	10.5	11.0	5.0	7.5	0.6	C322J223-30****	0.10	17.5	13.5	7.5	15.0	0.8	C322J104-60****	3.3	32.0	37.0	22.0	27.5	0.8	C322J335-B0****

备注 Note: 1. “-” 表示容量偏差。 “ ” =capacitance tolerance code. M=±20%, K=±10%, J=±5%, H=±3%, G=±2%。
 2. “****” 表示引线加工和包装代码(见表 1)。“****” =lead form and packing code (refer to table 1).
 3. “@” 不用作跨线, 请参见抗干扰电容器(Page 109)。
 “@” Not suitable for across-the-line application. Pls refer to Interference Suppression Capacitors(Page 109).

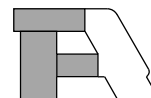

■ 外形尺寸 Dimensions(mm)

1 000V(400Vac)							1 600V(600Vac)							2 000V(700Vac)							
C _N (μF)	W	H	T	P	d	Part number	C _N (μF)	W	H	T	P	d	Part number	C _N (μF)	W	H	T	P	d	Part number	
0.0010	13.0	9.0	4.0	10.0	0.6	C323A102-40****	0.00056	17.5	11.0	5.0	15.0	0.8	C323C561-60****	0.00056	17.5	11.0	5.0	15.0	0.8	C323D561-60****	
0.0012	13.0	9.0	4.0	10.0	0.6	C323A122-40****	0.00062	17.5	11.0	5.0	15.0	0.8	C323C621-60****	0.00062	17.5	11.0	5.0	15.0	0.8	C323D621-60****	
0.0015	13.0	9.0	4.0	10.0	0.6	C323A152-40****	0.00068	17.5	11.0	5.0	15.0	0.8	C323C681-60****	0.00068	17.5	11.0	5.0	15.0	0.8	C323D681-60****	
0.0018	13.0	9.0	4.0	10.0	0.6	C323A182-40****	0.00082	17.5	11.0	5.0	15.0	0.8	C323C821-60****	0.00082	17.5	11.0	5.0	15.0	0.8	C323D821-60****	
0.0022	13.0	9.0	4.0	10.0	0.6	C323A222-40****	0.0010	17.5	11.0	5.0	15.0	0.8	C323C102-60****	0.0010	17.5	11.0	5.0	15.0	0.8	C323D102-60****	
0.0027	13.0	9.0	4.0	10.0	0.6	C323A272-40****	0.0012	17.5	11.0	5.0	15.0	0.8	C323C122-60****	0.0012	17.5	11.0	5.0	15.0	0.8	C323D122-60****	
0.0033	13.0	9.0	4.0	10.0	0.6	C323A332-40****	0.0015	17.5	11.0	5.0	15.0	0.8	C323C152-60****	0.0015	17.5	11.0	5.0	15.0	0.8	C323D152-60****	
0.0039	13.0	9.0	4.0	10.0	0.6	C323A392-40****	0.0018	17.5	11.0	5.0	15.0	0.8	C323C182-60****	0.0018	17.5	11.0	5.0	15.0	0.8	C323D182-60****	
0.0047	13.0	11.0	5.0	10.0	0.6	C323A472-40****	0.0022	17.5	11.0	5.0	15.0	0.8	C323C222-60****	0.0022	17.5	11.0	5.0	15.0	0.8	C323D222-60****	
0.0056	13.0	11.0	5.0	10.0	0.6	C323A562-40****	0.0027	17.5	11.0	5.0	15.0	0.8	C323C272-60****	0.0027	17.5	11.0	5.0	15.0	0.8	C323D272-60****	
0.0068	13.0	11.0	5.0	10.0	0.6	C323A682-40****	0.0033	17.5	11.0	5.0	15.0	0.8	C323C332-60****	0.0033	17.5	11.0	5.0	15.0	0.8	C323D332-60****	
0.0082	13.0	12.0	6.0	10.0	0.6	C323A822-40****	0.0039	17.5	11.0	5.0	15.0	0.8	C323C392-60****	0.0039	17.5	11.0	5.0	15.0	0.8	C323D392-60****	
0.010	13.0	12.0	6.0	10.0	0.6	C323A103-40****	0.0047	17.5	11.0	5.0	15.0	0.8	C323C472-60****	0.0047	17.5	11.0	5.0	15.0	0.8	C323D472-60****	
0.0022	17.5	11.0	5.0	15.0	0.8	C323A222-60****	0.0056	17.5	11.0	5.0	15.0	0.8	C323C562-60****	0.0056	17.5	12.0	6.0	15.0	0.8	C323D562-60****	
0.0027	17.5	11.0	5.0	15.0	0.8	C323A272-60****	0.0068	17.5	11.0	5.0	15.0	0.8	C323C682-60****	0.0068	17.5	12.0	6.0	15.0	0.8	C323D682-60****	
0.0033	17.5	11.0	5.0	15.0	0.8	C323A332-60****	0.0082	17.5	12.0	6.0	15.0	0.8	C323C822-60****	0.0082	17.5	13.5	7.5	15.0	0.8	C323D822-60****	
0.0039	17.5	11.0	5.0	15.0	0.8	C323A392-60****	0.010	17.5	12.0	6.0	15.0	0.8	C323C103-60****	0.010	17.5	13.5	7.5	15.0	0.8	C323D103-60****	
0.0047	17.5	11.0	5.0	15.0	0.8	C323A472-60****	0.012	17.5	12.0	6.0	15.0	0.8	C323C123-60****	0.012	17.5	14.5	8.5	15.0	0.8	C323D123-60****	
0.0056	17.5	11.0	5.0	15.0	0.8	C323A562-60****	0.015	17.5	13.5	7.5	15.0	0.8	C323C153-60****	0.015	17.5	14.5	8.5	15.0	0.8	C323D153-60****	
0.0068	17.5	11.0	5.0	15.0	0.8	C323A682-60****	0.018	17.5	13.5	7.5	15.0	0.8	C323C183-60****	0.018	17.5	16.0	10.0	15.0	0.8	C323D183-60****	
0.0082	17.5	11.0	5.0	15.0	0.8	C323A822-60****	0.022	17.5	14.5	8.5	15.0	0.8	C323C223-60****	0.022	17.5	19.0	11.0	15.0	0.8	C323D223-60****	
0.010	17.5	11.0	5.0	15.0	0.8	C323A103-60****	0.027	17.5	16.0	10.0	15.0	0.8	C323C273-60****	0.0068	26.5	15.0	6.0	22.5	0.8	C323D682-90****	
0.012	17.5	11.0	5.0	15.0	0.8	C323A123-60****	0.033	17.5	16.0	10.0	15.0	0.8	C323C333-60****	0.0082	26.5	15.0	6.0	22.5	0.8	C323D822-90****	
0.015	17.5	12.0	6.0	15.0	0.8	C323A153-60****	0.039	17.5	19.0	11.0	15.0	0.8	C323C393-60****	0.010	26.5	15.0	6.0	22.5	0.8	C323D103-90****	
0.018	17.5	12.0	6.0	15.0	0.8	C323A183-60****	0.047	17.5	19.0	11.0	15.0	0.8	C323C473-60****	0.012	26.5	15.0	6.0	22.5	0.8	C323D123-90****	
0.022	17.5	13.5	7.5	15.0	0.8	C323A223-60****	0.015	26.5	15.0	6.0	22.5	0.8	C323C153-90****	0.015	26.5	15.0	6.0	22.5	0.8	C323D153-90****	
0.027	17.5	13.5	7.5	15.0	0.8	C323A273-60****	0.018	26.5	15.0	6.0	22.5	0.8	C323C183-90****	0.018	26.5	16.0	7.0	22.5	0.8	C323D183-90****	
0.033	17.5	14.5	8.5	15.0	0.8	C323A333-60****	0.022	26.5	15.0	6.0	22.5	0.8	C323C223-90****	0.022	26.5	17.0	8.5	22.5	0.8	C323D223-90****	
0.039	17.5	16.0	10.0	15.0	0.8	C323A393-60****	0.027	26.5	16.0	7.0	22.5	0.8	C323C273-90****	0.027	26.5	17.0	8.5	22.5	0.8	C323D273-90****	
0.047	17.5	16.0	10.0	15.0	0.8	C323A473-60****	0.033	26.5	16.0	7.0	22.5	0.8	C323C333-90****	0.033	26.5	18.5	10.0	22.5	0.8	C323D333-90****	
0.056	17.5	19.0	11.0	15.0	0.8	C323A563-60****	0.039	26.5	17.0	8.5	22.5	0.8	C323C393-90****	0.039	26.5	18.5	10.0	22.5	0.8	C323D393-90****	
0.068	17.5	19.0	11.0	15.0	0.8	C323A683-60****	0.047	26.5	18.5	10.0	22.5	0.8	C323C473-90****	0.047	26.5	22.0	12.0	22.5	0.8	C323D473-90****	
0.018	26.5	15.0	6.0	22.5	0.8	C323A183-90****	0.056	26.5	18.5	10.0	22.5	0.8	C323C563-90****	0.056	26.5	22.0	12.0	22.5	0.8	C323D563-90****	
0.022	26.5	15.0	6.0	22.5	0.8	C323A223-90****	0.068	26.5	22.0	12.0	22.5	0.8	C323C683-90****								
0.027	26.5	15.0	6.0	22.5	0.8	C323A273-90****	0.082	26.5	22.0	12.0	22.5	0.8	C323C823-90****								
0.033	26.5	15.0	6.0	22.5	0.8	C323A333-90****	0.10	26.5	22.0	12.0	22.5	0.8	C323C104-90****								
0.039	26.5	15.0	6.0	22.5	0.8	C323A393-90****															
0.047	26.5	16.0	7.0	22.5	0.8	C323A473-90****															
0.056	26.5	16.0	7.0	22.5	0.8	C323A563-90****															
0.068	26.5	17.0	8.5	22.5	0.8	C323A683-90****															
0.082	26.5	17.0	8.5	22.5	0.8	C323A823-90****															
0.10	26.5	18.5	10.0	22.5	0.8	C323A104-90****															
0.12	26.5	22.0	12.0	22.5	0.8	C323A124-90****															
0.15	26.5	22.0	12.0	22.5	0.8	C323A154-90****															

备注 Note: 1. “-”表示容量偏差。 “-”=capacitance tolerance code. M=±20%, K=±10%, J=±5%, H=±3%, G=±2%。
2. “****”表示引线加工和包装代码(见表1)。“****”=lead form and packing code (refer to table 1).

X-ON Electronics

Largest Supplier of Electrical and Electronic Components

Click to view similar products for [Film Capacitors](#) category:

Click to view products by [FARATRONIC](#) manufacturer:

Other Similar products are found below :

[703-6G](#) [82DC4100CK60J](#) [82EC1100DQ50K](#) [MMWAF150KME](#) [PCY2130F30153](#) [QXJ2E474KTPT](#) [QXL2B333KTPT](#) [QXM2G104K](#)
[DPM16S56K-1F](#) [EEC2G505HQA406](#) [B32234-.033@250V-K](#) [B81133-C1104-M3](#) [MTC355L1](#) [217-0716-001](#) [PA225L30](#) [CB182K0184J--](#)
[KP1830-247/061-G](#) [274ACF4400WA0J](#) [274ACF5150WA0J](#) [SCD105K122A3-22](#) [SCD205K122A3-24](#) [PCX2339F65224](#) [PCX2339F65334](#)
[2222 368 55105](#) [2222 370 21683](#) [QXL2E473KTPT](#) [445450-1](#) [MKT182022263473](#) [46KN410000N1K](#) [46KR368050M1M](#) [ECQ-W4223KZ](#)
[EEC2G805HQA415](#) [PA103L30](#) [82DC4100AA60K](#) [82EC2150DQ50K](#) [VEA105K50](#) [82IC2150DQ50J](#) [82EC2220DQ50J](#) [MTC55L4](#)
[MTC56L4](#) [PA104L30](#) [PA224L30](#) [82DC3220AA60J](#) [82EC4100DQ70J](#) [WYP-104M](#) [82CC4220AA70J](#) [82EC3100Z370J](#) [B32656S8105K566](#)
[EEC2G105HQA401](#) [QXL2B223KTPT](#)