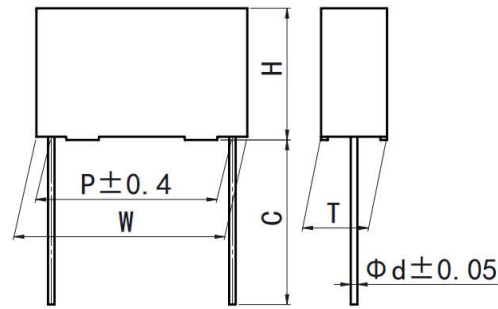

**Version history**

Current version	Date	Author	Change description

**Metallized polypropylene film capacitor (Box-type)**
**■ Outline Drawing**

 $W \pm 0.4, H \pm 0.4, T \pm 0.4$ 
**■ Features**

- Metallized polypropylene structure.
- Excellent electric property.
- Plastic case (UL94 V-0), Epoxy resin sealing.

**■ Typical Applications**

- As intermediate circuit capacitors for SMPS, Electronic Ballast, inverter(i.e. DC-link, DC-filter and P.F.C)

**■ Specifications**

Reference Standard	GB/T 10190(IEC 60384-16)								
Climatic Category	40/105/56								
Rated Temperature	85°C								
Operating Temperature Range	-40°C~105°C (+85°C to +105°C: decreasing factor 1.25% per °C for $U_R$ )								
Rated Voltage	450Vdc, 520Vdc, 630Vdc								
Capacitance Range	0.022 $\mu$ F~22 $\mu$ F								
Capacitance Tolerance	$\pm 5\%$ (J), $\pm 10\%$ (K), $\pm 20\%$ (M)								
Voltage Proof	1.6 $U_R$ (5s)								
Dissipation Factor	$\leq 15 \times 10^{-4}$ (20°C, 1kHz)								
Insulation Resistance	$R \geq 100\,000\text{M}\Omega, C_N \leq 0.33\mu\text{F}$ $RC_N \geq 15\,000\text{s}, C_N > 0.33\mu\text{F}$								
Maximum Pulse Rise Time(dV/dt) If the working voltage(U) is lower than the rated voltage( $U_R$ ),the capacitor can be worked at a higher dV/dt. In this case, the maximum allowed dV/dt is obtain by multiplying the right value with $U_R/U$ .	$U_R$ (V)	Max dV/dt(V/us) ——Miniature version				Max dV/dt(V/us)			
		P=10.0	P=15.0	P=22.5	P=27.5	P=10.0	P=15.0	P=22.5	P=27.5
	450	100	65	35	20	300	200	100	80
	520	120	80	60	40	350	220	150	100
	630	200	160	70	50	400	300	180	120

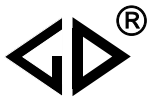

**Part number system**

The 15 digits part number is formed as follow:

1 2 3 4 5 6 7 8 9 10 11 12 13 14 15

C	3	5												
---	---	---	--	--	--	--	--	--	--	--	--	--	--	--

Digit 1 to 3 Series code

C35=MKP25

Digit 4 to 5 D.C. rated voltage:

2S=450V 2T=520V 2J=630V

Digit 6 to 8 Rated capacitance value

For example: 103=10 × 10<sup>3</sup>pf=0.01uF

Digit 9 Capacitance tolerance

J=±5%, K=±10%, M=±20%

Digit 10 Pitch

4=10.0mm 6=15.0mm

9=22.5mm B=27.5mm

Digit 11 Internal use

Digit 12 to 15 Lead form and packaging code

**Table1 Lead form and packaging code**

Digit 12		Digit 13		Digit 14		Digit 15	
code	explanation	code	explanation	code	explanation	code	explanation
A	ammo-pack	46	F=10.0mm F=15.0mm	0	straight	5	P3=25.4mm;H=18.5mm (For pitch=10/15mm)
F	lead kinked	46	F=10.0mm F=15.0mm	0	B=4.5mm (the length of B)	0	B Length tolerance ±0.5mm
C	straight lead "C" in the figure above	code	explanation			0	Length tolerance ±0.5mm Or standard length
		00	standard lead length (18mm~26mm)				
		45	lead length 4.5mm				

Note: Recommend short lead due to long lead could deform easily.



■ Dimensions (mm) ---Miniature version (Small sizes+ Segmented metallized-film design)

450Vdc							520Vdc							630Vdc						
C <sub>N</sub> (μF)	W	H	T	P	d	Part number	C <sub>N</sub> (μF)	W	H	T	P	d	Part number	C <sub>N</sub> (μF)	W	H	T	P	d	Part number
0.12	13.0	9.0	4.0	10.0	0.6	C352S124-4S****	0.082	13.0	9.0	4.0	10.0	0.6	C352T823-4S****	0.056	13.0	9.0	4.0	10.0	0.6	C352J563-4S****
0.15	13.0	9.0	4.0	10.0	0.6	C352S154-4S****	0.10	13.0	9.0	4.0	10.0	0.6	C352T104-4S****	0.068	13.0	9.0	4.0	10.0	0.6	C352J683-4S****
0.18	13.0	11.0	5.0	10.0	0.6	C352S184-4S****	0.12	13.0	11.0	5.0	10.0	0.6	C352T124-4S****	0.082	13.0	11.0	5.0	10.0	0.6	C352J823-4S****
0.22	13.0	11.0	5.0	10.0	0.6	C352S224-4S****	0.15	13.0	11.0	5.0	10.0	0.6	C352T154-4S****	0.10	13.0	11.0	5.0	10.0	0.6	C352J104-4S****
0.27	13.0	12.0	6.0	10.0	0.6	C352S274-4S****	0.18	13.0	12.0	6.0	10.0	0.6	C352T184-4S****	0.12	13.0	12.0	6.0	10.0	0.6	C352J124-4S****
0.33	13.0	12.0	6.0	10.0	0.6	C352S334-4S****	0.22	13.0	12.0	6.0	10.0	0.6	C352T224-4S****	0.15	13.0	12.0	6.0	10.0	0.6	C352J154-4S****
0.39	13.0	13.0	7.0	10.0	0.6	C352S394-4S****	0.27	13.0	13.0	7.0	10.0	0.6	C352T274-4S****	0.18	13.0	13.0	7.0	10.0	0.6	C352J184-4S****
0.47	13.0	13.0	7.0	10.0	0.6	C352S474-4S****	0.33	13.0	13.0	7.0	10.0	0.6	C352T334-4S****	0.22	13.0	13.0	7.0	10.0	0.6	C352J224-4S****
0.56	13.0	14.0	8.0	10.0	0.6	C352S564-4S****	0.39	13.0	14.0	8.0	10.0	0.6	C352T394-4S****	0.27	13.0	14.0	8.0	10.0	0.6	C352J274-4S****
0.68	13.0	14.0	8.0	10.0	0.6	C352S684-4S****	0.47	13.0	14.0	8.0	10.0	0.6	C352T474-4S****	0.33	13.0	14.0	8.0	10.0	0.6	C352J334-4S****
0.22	17.5	11.0	5.0	15.0	0.6	C352S224-6S****	0.27	17.5	11.0	5.0	15.0	0.6	C352T274-6S****	0.18	17.5	11.0	5.0	15.0	0.6	C352J184-6S****
0.33	17.5	11.0	5.0	15.0	0.6	C352S334-6S****	0.33	17.5	11.0	5.0	15.0	0.6	C352T334-6S****	0.22	17.5	11.0	5.0	15.0	0.6	C352J224-6S****
0.39	17.5	11.0	5.0	15.0	0.6	C352S394-6S****	0.39	17.5	12.0	6.0	15.0	0.6	C352T394-6S****	0.27	17.5	12.0	6.0	15.0	0.6	C352J274-6S****
0.47	17.5	11.0	5.0	15.0	0.6	C352S474-6S****	0.47	17.5	12.0	6.0	15.0	0.6	C352T474-6S****	0.33	17.5	12.0	6.0	15.0	0.6	C352J334-6S****
0.56	17.5	12.0	6.0	15.0	0.6	C352S564-6S****	0.56	17.5	12.0	7.0	15.0	0.6	C352T564-6S****	0.39	17.5	12.0	7.0	15.0	0.6	C352J394-6S****
0.68	17.5	12.0	7.0	15.0	0.6	C352S684-6S****	0.68	17.5	13.5	7.5	15.0	0.6	C352T684-6S****	0.47	17.5	13.5	7.5	15.0	0.6	C352J474-6S****
0.82	17.5	12.0	7.0	15.0	0.6	C352S824-6S****	0.82	17.5	14.0	8.0	15.0	0.6	C352T824-6S****	0.56	17.5	14.0	8.0	15.0	0.6	C352J564-6S****
1.0	17.5	13.5	7.5	15.0	0.6	C352S105-6S****	1.0	17.5	14.5	8.5	15.0	0.6	C352T105-6S****	0.68	17.5	14.5	8.5	15.0	0.6	C352J684-6S****
1.2	17.5	14.0	8.0	15.0	0.6	C352S125-6S****	1.2	17.5	16.0	10.0	15.0	0.8	C352T125-6S****	0.82	17.5	16.0	10.0	15.0	0.8	C352J824-6S****
1.5	17.5	16.0	10.0	15.0	0.8	C352S155-6S****	1.5	17.5	19.0	11.0	15.0	0.8	C352T155-6S****	1.0	17.5	16.0	10.0	15.0	0.8	C352J105-6S****
1.8	17.5	16.0	10.0	15.0	0.8	C352S185-6S****	0.68	26.5	15.0	6.0	22.5	0.8	C352T684-9S****	1.2	17.5	19.0	11.0	15.0	0.8	C352J125-6S****
2.2	17.5	19.0	11.0	15.0	0.8	C352S225-6S****	0.82	26.5	15.0	6.0	22.5	0.8	C352T824-9S****	0.47	26.5	15.0	6.0	22.5	0.8	C352J474-9S****
1.0	26.5	15.0	6.0	22.5	0.8	C352S105-9S****	1.0	26.5	16.0	7.0	22.5	0.8	C352T105-9S****	0.56	26.5	15.0	6.0	22.5	0.8	C352J564-9S****
1.2	26.5	15.0	6.0	22.5	0.8	C352S125-9S****	1.2	26.5	16.0	7.0	22.5	0.8	C352T125-9S****	0.68	26.5	16.0	7.0	22.5	0.8	C352J684-9S****
1.5	26.5	16.0	7.0	22.5	0.8	C352S155-9S****	1.5	26.5	17.0	8.5	22.5	0.8	C352T155-9S****	0.82	26.5	16.0	7.0	22.5	0.8	C352J824-9S****
1.8	26.5	16.0	7.0	22.5	0.8	C352S185-9S****	1.8	26.5	17.0	8.5	22.5	0.8	C352T185-9S****	1.0	26.5	17.0	8.5	22.5	0.8	C352J105-9S****
2.2	26.5	17.0	8.5	22.5	0.8	C352S225-9S****	2.2	26.5	18.5	10.0	22.5	0.8	C352T225-9S****	1.2	26.5	17.0	8.5	22.5	0.8	C352J125-9S****
2.7	26.5	17.0	8.5	22.5	0.8	C352S275-9S****	2.7	26.5	18.5	10.0	22.5	0.8	C352T275-9S****	1.5	26.5	18.5	10.0	22.5	0.8	C352J155-9S****
3.3	26.5	18.5	10.0	22.5	0.8	C352S335-9S****	3.3	26.5	20.0	11.0	22.5	0.8	C352T335-9S****	1.8	26.5	18.5	10.0	22.5	0.8	C352J185-9S****
3.9M	26.5	18.5	10.0	22.5	0.8	C352S395M9S****	3.9	26.5	22.0	12.0	22.5	0.8	C352T395-9S****	2.2	26.5	20.0	11.0	22.5	0.8	C352J225-9S****
4.7K	26.5	20.0	11.0	22.5	0.8	C352S475K9S****	4.7	26.5	24.5	15.5	22.5	0.8	C352T475-9S****	2.7	26.5	22.0	12.0	22.5	0.8	C352J275-9S****
5.6	26.5	22.0	12.0	22.5	0.8	C352S565-9S****	5.6	26.5	24.5	15.5	22.5	0.8	C352T565-9S****	3.3	26.5	24.5	15.5	22.5	0.8	C352J335-9S****
6.8	26.5	24.5	15.5	22.5	0.8	C352S685-9S****	2.2	32.0	18.0	9.0	27.5	0.8	C352T225-BS****	3.9	26.5	24.5	15.5	22.5	0.8	C352J395-9S****
8.2	26.5	24.5	15.5	22.5	0.8	C352S825-9S****	2.7	32.0	18.0	9.0	27.5	0.8	C352T275-BS****	1.8	32.0	18.0	9.0	27.5	0.8	C352J185-BS****
3.3	32.0	18.0	9.0	27.5	0.8	C352S335-BS****	3.3	32.0	20.0	11.0	27.5	0.8	C352T335-BS****	2.2	32.0	20.0	11.0	27.5	0.8	C352J225-BS****
3.9M	32.0	18.0	9.0	27.5	0.8	C352S395MBS****	3.9	32.0	20.0	11.0	27.5	0.8	C352T395-BS****	2.7	32.0	20.0	11.0	27.5	0.8	C352J275-BS****
4.7	32.0	20.0	11.0	27.5	0.8	C352S475-BS****	4.7	32.0	22.0	13.0	27.5	0.8	C352T475-BS****	3.3	32.0	22.0	13.0	27.5	0.8	C352J335-BS****
5.6M	32.0	20.0	11.0	27.5	0.8	C352S565MBS****	5.6	32.0	22.0	13.0	27.5	0.8	C352T565-BS****	3.9M	32.0	22.0	13.0	27.5	0.8	C352J395MBS****
6.8	32.0	22.0	13.0	27.5	0.8	C352S685-BS****	6.8	32.0	24.5	15.0	27.5	0.8	C352T685-BS****	4.7	32.0	24.5	15.0	27.5	0.8	C352J475-BS****
8.2	32.0	24.5	15.0	27.5	0.8	C352S825-BS****	8.2	32.0	28.0	14.0	27.5	0.8	C352T825-BS****	5.6	32.0	28.0	17.0	27.5	0.8	C352J565-BS****
10.0M	32.0	24.5	15.0	27.5	0.8	C352S106MBS****	10.0M	32.0	28.0	17.0	27.5	0.8	C352T106MBS****	6.8	32.0	28.0	17.0	27.5	0.8	C352J685-BS****
12.0	32.0	28.0	17.0	27.5	0.8	C352S126-BS****	12.0	32.0	33.0	18.0	27.5	0.8	C352T126-BS****	8.2M	32.0	29.0	19.0	27.5	0.8	C352J825MBS****
15.0	32.0	33.0	18.0	27.5	0.8	C352S156-BS****	15.0	32.0	37.0	22.0	27.5	0.8	C352T156-BS****	10.0	32.0	37.0	22.0	27.5	0.8	C352J106-BS****
18.0	32.0	37.0	22.0	27.5	0.8	C352S186-BS****	18.0	32.0	37.0	22.0	27.5	0.8	C352T186-BS****	12.0	32.0	37.0	22.0	27.5	0.8	C352J126-BS****
22.0	32.0	37.0	22.0	27.5	0.8	C352S226-BS****														

Note: 1. “-” =capacitance tolerance code, M=±20%,K=±10%,J=±5%  
 2. “\*\*\*\*” =lead form and packaging code (refer to table 1)



■ Dimensions (mm)

450Vdc							450Vdc							520Vdc						
C <sub>N</sub> (μF)	W	H	T	P	d	Part number	C <sub>N</sub> (μF)	W	H	T	P	d	Part number	C <sub>N</sub> (μF)	W	H	T	P	d	Part number
0.068	13.0	9.0	4.0	10.0	0.6	C352S683-40****	1.2	26.5	18.5	10.0	22.5	0.8	C352S125-90****	0.047	13.0	9.0	4.0	10.0	0.6	C352T473-40****
0.082	13.0	9.0	4.0	10.0	0.6	C352S823-40****	1.5	26.5	18.5	10.0	22.5	0.8	C352S155-90****	0.056	13.0	9.0	4.0	10.0	0.6	C352T563-40****
0.10	13.0	11.0	5.0	10.0	0.6	C352S104-40****	1.8	26.5	22.0	12.0	22.5	0.8	C352S185-90****	0.068	13.0	9.0	4.0	10.0	0.6	C352T683-40****
0.12	13.0	11.0	5.0	10.0	0.6	C352S124-40****	0.68	32.0	18.0	9.0	27.5	0.8	C352S684-B0****	0.082	13.0	11.0	5.0	10.0	0.6	C352T823-40****
0.15	13.0	12.0	6.0	10.0	0.6	C352S154-40****	0.82	32.0	18.0	9.0	27.5	0.8	C352S824-B0****	0.1	13.0	11.0	5.0	10.0	0.6	C352T104-40****
0.18	13.0	12.0	6.0	10.0	0.6	C352S184-40****	1.0	32.0	18.0	9.0	27.5	0.8	C352S105-B0****	0.12	13.0	12.0	6.0	10.0	0.6	C352T124-40****
0.22	13.0	13.0	7.0	10.0	0.6	C352S224-40****	1.2	32.0	18.0	9.0	27.5	0.8	C352S125-B0****	0.15	13.0	12.0	6.0	10.0	0.6	C352T154-40****
0.27	13.0	13.0	7.0	10.0	0.6	C352S274-40****	1.5	32.0	18.0	9.0	27.5	0.8	C352S155-B0****	0.18	13.0	13.0	7.0	10.0	0.6	C352T184-40****
0.33	13.0	14.0	8.0	10.0	0.6	C352S334-40****	1.8	32.0	20.0	11.0	27.5	0.8	C352S185-B0****	0.22	13.0	13.0	7.0	10.0	0.6	C352T224-40****
0.10	17.5	9.5	5.0	15.0	0.6	C352S104-6A****	2.2	32.0	20.0	11.0	27.5	0.8	C352S225-B0****	0.27	13.0	14.0	8.0	10.0	0.6	C352T274-40****
0.12	17.5	9.5	5.0	15.0	0.6	C352S124-6A****	2.7	32.0	22.0	13.0	27.5	0.8	C352S275-B0****	0.033	17.5	9.5	5.0	15.0	0.6	C352T333-6A****
0.15	17.5	11.0	5.0	15.0	0.6	C352S154-6A****	3.3	32.0	22.0	13.0	27.5	0.8	C352S335-B0****	0.039	17.5	9.5	5.0	15.0	0.6	C352T393-6A****
0.18	17.5	11.0	5.0	15.0	0.6	C352S184-6A****	3.9	32.0	24.5	15.0	27.5	0.8	C352S395-B0****	0.047	17.5	11.0	5.0	15.0	0.6	C352T473-6A****
0.22	17.5	11.0	5.0	15.0	0.6	C352S224-6A****	4.7	32.0	33.0	18.0	27.5	0.8	C352S475-B0****	0.056	17.5	11.0	5.0	15.0	0.6	C352T563-6A****
0.27	17.5	12.0	6.0	15.0	0.6	C352S274-6A****	5.6	32.0	33.0	18.0	27.5	0.8	C352S565-B0****	0.068	17.5	11.0	5.0	15.0	0.6	C352T683-6A****
0.33	17.5	12.0	6.0	15.0	0.6	C352S334-6A****	6.8	32.0	33.0	18.0	27.5	0.8	C352S685-B0****	0.082	17.5	11.0	5.0	15.0	0.6	C352T823-6A****
0.39	17.5	13.5	7.5	15.0	0.6	C352S394-6A****	8.2	32.0	33.0	18.0	27.5	0.8	C352S825-B0****	0.1	17.5	11.0	5.0	15.0	0.6	C352T104-6A****
0.47	17.5	13.5	7.5	15.0	0.6	C352S474-6A****								0.12	17.5	11.0	5.0	15.0	0.6	C352T124-6A****
0.56	17.5	13.5	7.5	15.0	0.6	C352S564-6A****								0.15	17.5	11.0	5.0	15.0	0.6	C352T154-6A****
0.68	17.5	16.0	10.0	15.0	0.8	C352S684-60****								0.18	17.5	11.0	5.0	15.0	0.6	C352T184-6A****
0.82	17.5	16.0	10.0	15.0	0.8	C352S824-60****								0.22	17.5	12.0	6.0	15.0	0.6	C352T224-6A****
1.0	17.5	19.0	11.0	15.0	0.8	C352S105-60****								0.27	17.5	12.0	6.0	15.0	0.6	C352T274-6A****
0.27	26.5	15.0	6.0	22.5	0.6	C352S274-9A****								0.33	17.5	13.5	7.5	15.0	0.6	C352T334-6A****
0.33	26.5	15.0	6.0	22.5	0.6	C352S334-9A****								0.39	17.5	13.5	7.5	15.0	0.6	C352T394-6A****
0.39	26.5	15.0	6.0	22.5	0.6	C352S394-9A****								0.47	17.5	14.5	8.5	15.0	0.8	C352T474-60****
0.47	26.5	15.0	6.0	22.5	0.6	C352S474-9A****								0.56	17.5	16.0	10.0	15.0	0.8	C352T564-60****
0.56	26.5	16.0	7.0	22.5	0.6	C352S564-9A****								0.68	17.5	16.0	10.0	15.0	0.8	C352T684-60****
0.68	26.5	16.0	7.0	22.5	0.6	C352S684-9A****								0.82	17.5	19.0	11.0	15.0	0.8	C352T824-60****
0.82	26.5	16.0	7.0	22.5	0.6	C352S824-9A****								1.0	17.5	19.0	11.0	15.0	0.8	C352T105-60****
1.0	26.5	17.0	8.5	22.5	0.8	C352S105-90****								0.18	26.5	15.0	6.0	22.5	0.6	C352T184-9A****

Note: 1. “-” =capacitance tolerance code, M=±20%,K=±10%,J=±5%  
 2. “\*\*\*\*” =lead form and packaging code (refer to table 1)

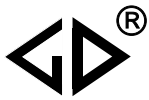

■ Dimensions (mm)

520Vdc (200Vac)							630Vdc							630Vdc						
C <sub>N</sub> (μF)	W	H	T	P	d	Part number	C <sub>N</sub> (μF)	W	H	T	P	d	Part number	C <sub>N</sub> (μF)	W	H	T	P	d	Part number
0.22	26.5	15.0	6.0	22.5	0.6	C352J224-9A****	0.022	13.0	9.0	4.0	10.0	0.6	C352J223-40****	0.18	26.5	15.0	6.0	22.5	0.6	C352J184-9A****
0.27	26.5	15.0	6.0	22.5	0.6	C352J274-9A****	0.027	13.0	9.0	4.0	10.0	0.6	C352J273-40****	0.22	26.5	15.0	6.0	22.5	0.6	C352J224-9A****
0.33	26.5	15.0	6.0	22.5	0.6	C352J334-9A****	0.033	13.0	9.0	4.0	10.0	0.6	C352J333-40****	0.27	26.5	15.0	6.0	22.5	0.6	C352J274-9A****
0.39	26.5	16.0	7.0	22.5	0.6	C352J394-9A****	0.039	13.0	9.0	4.0	10.0	0.6	C352J393-40****	0.33	26.5	15.0	6.0	22.5	0.6	C352J334-9A****
0.47	26.5	16.0	7.0	22.5	0.6	C352J474-9A****	0.047	13.0	11.0	5.0	10.0	0.6	C352J473-40****	0.39	26.5	16.0	7.0	22.5	0.6	C352J394-9A****
0.56	26.5	17.0	8.5	22.5	0.8	C352J564-90****	0.056	13.0	11.0	5.0	10.0	0.6	C352J563-40****	0.47	26.5	16.0	7.0	22.5	0.6	C352J474-9A****
0.68	26.5	17.0	8.5	22.5	0.8	C352J684-90****	0.068	13.0	11.0	5.0	10.0	0.6	C352J683-40****	0.56	26.5	17.0	8.5	22.5	0.8	C352J564-90****
0.82	26.5	18.5	10.0	22.5	0.8	C352J824-90****	0.082	13.0	12.0	6.0	10.0	0.6	C352J823-40****	0.68	26.5	17.0	8.5	22.5	0.8	C352J684-90****
1.0	26.5	18.5	10.0	22.5	0.8	C352J105-90****	0.10	13.0	12.0	6.0	10.0	0.6	C352J104-40****	0.82	26.5	18.5	10.0	22.5	0.8	C352J824-90****
1.2	26.5	22.0	12.0	22.5	0.8	C352J125-90****	0.12	13.0	13.0	7.0	10.0	0.6	C352J124-40****	1.0	26.5	18.5	10.0	22.5	0.8	C352J105-90****
0.27	32.0	18.0	9.0	27.5	0.8	C352J274-B0****	0.15	13.0	13.0	7.0	10.0	0.6	C352J154-40****	1.2	26.5	22.0	12.0	22.5	0.8	C352J125-90****
0.33	32.0	18.0	9.0	27.5	0.8	C352J334-B0****	0.18	13.0	14.0	8.0	10.0	0.6	C352J184-40****	0.27	32.0	18.0	9.0	27.5	0.8	C352J274-B0****
0.39	32.0	18.0	9.0	27.5	0.8	C352J394-B0****	0.068	17.5	9.5	5.0	15.0	0.6	C352J683-6A****	0.33	32.0	18.0	9.0	27.5	0.8	C352J334-B0****
0.47	32.0	18.0	9.0	27.5	0.8	C352J474-B0****	0.082	17.5	11.0	5.0	15.0	0.6	C352J823-6A****	0.39	32.0	18.0	9.0	27.5	0.8	C352J394-B0****
0.56	32.0	18.0	9.0	27.5	0.8	C352J564-B0****	0.10	17.5	11.0	5.0	15.0	0.6	C352J104-6A****	0.47	32.0	18.0	9.0	27.5	0.8	C352J474-B0****
0.68	32.0	18.0	9.0	27.5	0.8	C352J684-B0****	0.12	17.5	11.0	5.0	15.0	0.6	C352J124-6A****	0.56	32.0	18.0	9.0	27.5	0.8	C352J564-B0****
0.82	32.0	18.0	9.0	27.5	0.8	C352J824-B0****	0.15	17.5	12.0	6.0	15.0	0.6	C352J154-6A****	0.68	32.0	18.0	9.0	27.5	0.8	C352J684-B0****
1.0	32.0	20.0	11.0	27.5	0.8	C352J105-B0****	0.18	17.5	12.0	6.0	15.0	0.6	C352J184-6A****	0.82	32.0	18.0	9.0	27.5	0.8	C352J824-B0****
1.2	32.0	20.0	11.0	27.5	0.8	C352J125-B0****	0.22	17.5	13.5	7.5	15.0	0.6	C352J224-6A****	1.0	32.0	20.0	11.0	27.5	0.8	C352J105-B0****
1.5	32.0	22.0	13.0	27.5	0.8	C352J155-B0****	0.27	17.5	13.5	7.5	15.0	0.6	C352J274-6A****	1.2	32.0	20.0	11.0	27.5	0.8	C352J125-B0****
1.8	32.0	22.0	13.0	27.5	0.8	C352J185-B0****	0.33	17.5	14.5	8.5	15.0	0.8	C352J334-60****	1.5	32.0	22.0	13.0	27.5	0.8	C352J155-B0****
2.2	32.0	24.5	15.0	27.5	0.8	C352J225-B0****	0.39	17.5	16.0	10.0	15.0	0.8	C352J394-60****	1.8	32.0	22.0	13.0	27.5	0.8	C352J185-B0****
2.7	32.0	28.0	14.0	27.5	0.8	C352J275-B0****	0.47	17.5	16.0	10.0	15.0	0.8	C352J474-60****	2.2	32.0	24.5	15.0	27.5	0.8	C352J225-B0****
3.3	32.0	33.0	18.0	27.5	0.8	C352J335-B0****	0.56	17.5	19.0	11.0	15.0	0.8	C352J564-60****	2.7	32.0	28.0	14.0	27.5	0.8	C352J275-B0****
3.9	32.0	33.0	18.0	27.5	0.8	C352J395-B0****	0.68	17.5	19.0	11.0	15.0	0.8	C352J684-60****	3.3	32.0	33.0	18.0	27.5	0.8	C352J335-B0****
4.7	32.0	33.0	18.0	27.5	0.8	C352S475-B0****	0.15	26.5	15.0	6.0	22.5	0.6	C352J154-9A****	3.9	32.0	33.0	18.0	27.5	0.8	C352J395-B0****
5.6	32.0	33.0	18.0	27.5	0.8	C352S565-B0****														
6.8	32.0	33.0	18.0	27.5	0.8	C352S685-B0****														
8.2	32.0	33.0	18.0	27.5	0.8	C352S825-B0****														

Note: 1. “-” =capacitance tolerance code, M=±20%,K=±10%,J=±5%  
 2. “\*\*\*\*” =lead form and packaging code (refer to table 1)

■ Max. Current (Ir.m.s.) versus Frequency – Miniature version

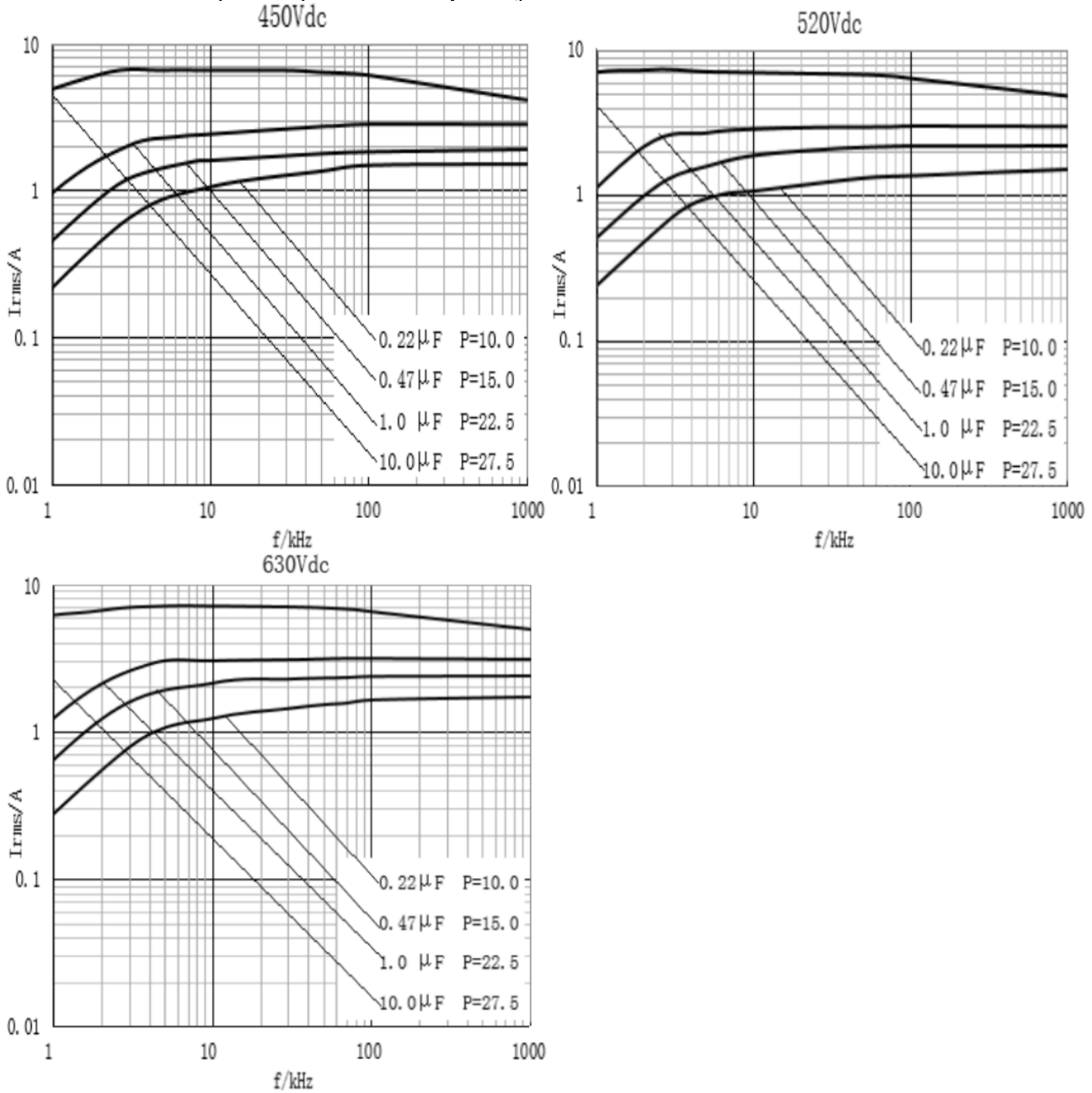

NOTE: 1. sinusoidal wave-form, environment temperature  $\leq 85^\circ C$ , internal temperature rise  $\Delta T=10^\circ C$ , p (pitch) in mm.

2. The series product is only recommended to use in DC-filter or DC-blocking circuits. It means the voltage applied to the capacitors must be unidirectional ripple voltage. The typical voltage curve is as follows reference. If you have any questions for this note, please feel free to contact with our technical engineer.

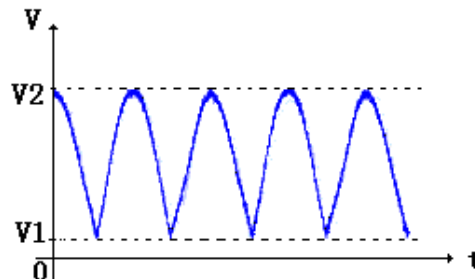

Here:  $V_1 \geq 0$ ,  $V_2 \leq U_R$ ,  $I_{rms} = 2 \pi f \times C \times (V_2 - V_1) / \sqrt{2}$   
 $U_R$  is the rated voltage of the capacitor

■ Max. Current (I<sub>r.m.s.</sub>) versus Frequency

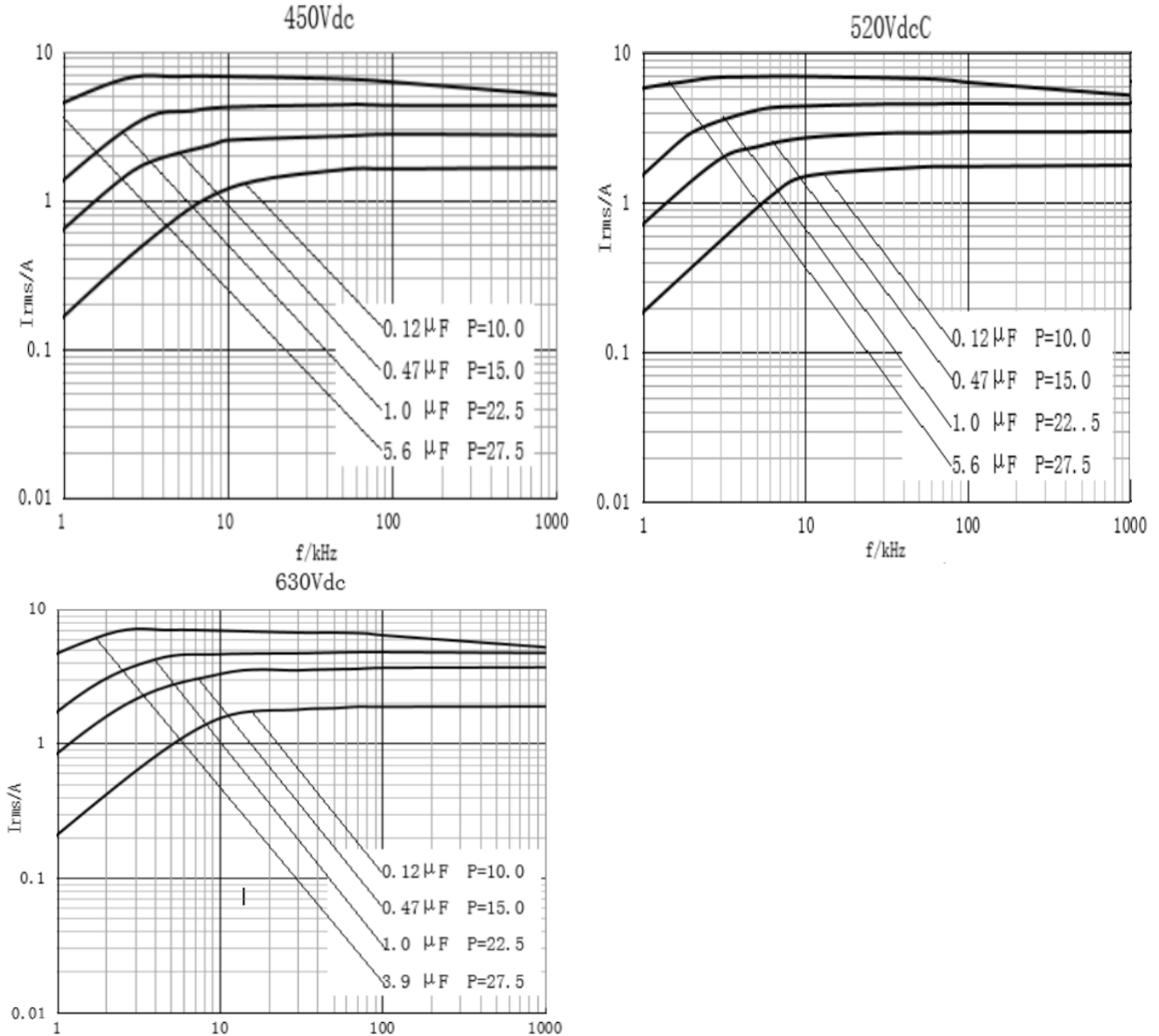

NOTE: 1. sinusoidal wave-form, environment temperature ≤ 85°C, internal temperature rise ΔT=10°C, p (pitch) in mm.

2. The series product is only recommended to use in DC-filter or DC-blocking circuits. It means the voltage applied to the capacitors must be unidirectional ripple voltage. The typical voltage curve is as follows reference. If you have any questions for this note, please feel free to contact with our technical engineer.

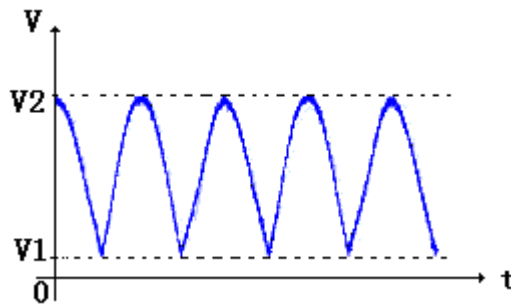

Here:  $V_1 \geq 0, V_2 \leq U_R, I_{rms} = 2\pi fC (V_2 - V_1)/\sqrt{2}$   
 $U_R$  is the rated voltage of the capacitor



**■ Test Method And Performance**

No.	Item	Performance	Test method(IEC 60384-16)
1	Solderability	Good quality of tinning	Solder temperature: 245°C ±5°C Immersion time: 2.0s±0.5s
2	Initial measurement	Capacitance Tgδ: 1kHz, C>1.0μF 10kHz, C≤1.0μF	
	Terminal strength	There shall be no visible damage	Tension: 10N(0.6≤φd≤0.8) 20N(φd=1.0) Bend: 5N(0.6≤φd≤0.8) 10N(φd=1.0) The terminals shall be bent 2 times in each direction.
	Resistance to solder heat	There shall be no visible damage	Solder temperature:260°C±5°C Immersion time: 10s±1s
	Final measurement	Δ C/C ≤ ± 3 % (relative to the initial value) Increase of tgδ: ≤0.004 (10kHz, C≤1.0μF) ≤0.004 (1kHz, C>1.0μF)	
3	Initial measurement	Capacitance Tgδ: 1kHz, C>1.0μF 10kHz, C≤1.0μF	
	Rapid change of temperature	There shall be no evidence of deterioration.	θ <sub>A</sub> =-40°C, θ <sub>B</sub> =+105°C 5 cycles Duration: t=30min
	Vibration	There shall be no evidence of deterioration.	Amplitude 0.75mm or acceleration 98m/s <sup>2</sup> (whichever is the smaller severity), f: 10Hz to 500Hz.Three directions, 2h for each direction, total 6h.
	Bump	There shall be no evidence of deterioration.	4 000 times, Acceleration: 390m/s <sup>2</sup> ,Pulse duration, 6ms
	Final measurement	Δ C/C ≤ ± 3 % (relative to the initial value) Increase of tgδ: ≤0.004 (10kHz, C≤1.0μF) ≤0.004 (1kHz, C>1.0μF) IR: ≥ 50% of the rated value	
4	Climate sequence	Initial measurement	Capacitance Tgδ: 1kHz, C>1.0μF 10kHz, C≤1.0μF
		Dry heat	+105°C, 16h
		Damp heat, Cyclic	Test Db, Severity: b, the first cycle
		Cold	-40°C, 2h
		Low air pressure	There shall be no permanent breakdown, flashover or other harmful deformation when applying U <sub>R</sub> at the last 1 minute. 15°C~35°C, 8.5kPa, 1h
		Damp heat, Cyclic other	Applying U <sub>R</sub> for 1 minute after 15 minutes the test finished. Test Db, Severity b, the other cycles,
		Final measurement	There shall be no visible damage, legible marking Δ C/C ≤ ± 5 % (relative to the initial value) Increase of tgδ: ≤0.005 (C≤1.0μF,10kHz) ≤0.005(C>1.0μF,1kHz) I.R.: ≥ 50% of the rated value

No.	Item	Performance	Test method(IEC 60384-16)
5	Damp heat steady state	There shall be no visible damage, legible marking $\Delta C/C \leq \pm 5\%$ (relative to the initial value) Increase of $\text{tg}\delta: \leq 0.002$ (1kHz) I.R.: $\geq 50\%$ of the rated value	Temperature: $40^\circ\text{C} \pm 2^\circ\text{C}$ Humidity: $93 \pm 3\%$ RH Duration: 56 days
6	Endurance	There shall be no visible damage, legible marking $\Delta C/C \leq \pm 5\%$ (relative to the initial value) Increase of $\text{tg}\delta$ : $\leq 0.004$ (10kHz, $C \leq 1.0\mu\text{F}$ ) $\leq 0.004$ (1kHz, $C > 1.0\mu\text{F}$ ) I.R.: $\geq 50\%$ of the rated value	Temperature: $+85^\circ\text{C}$ Voltage: $1.25 \times U_R$ Duration: 1 000h
7	Charging and discharging	$\Delta C/C \leq \pm 5\%$ (relative to the initial value) Increase of $\text{tg}\delta$ : $\leq 0.005$ ( $C \leq 1.0\mu\text{F}$ , 10kHz) $\leq 0.005$ ( $C > 1.0\mu\text{F}$ , 1kHz) I.R.: $\geq 50\%$ of the rated value	Times: 10 000 Duration of charging: 0.5s Duration of discharging: 0.5s Charging voltage: rated voltage $U_R$ Charging resistance: $220/C_N(\Omega)$ Discharging resistance: $U_R \div C_N \div dv/dt(\Omega)$ $C_N$ : rated capacitance ( $\mu\text{F}$ ) dv/dt value: see P2

**■ Marking (For example)**

 104J 630	 MKP25 684J 630
$P \leq 10\text{mm}$	$P > 10\text{mm}$

**Marking Introduction:**

	Brand	MKP25	Type
630	Rated voltage	104 684	Rated capacitance
J	Tolerance	—	—

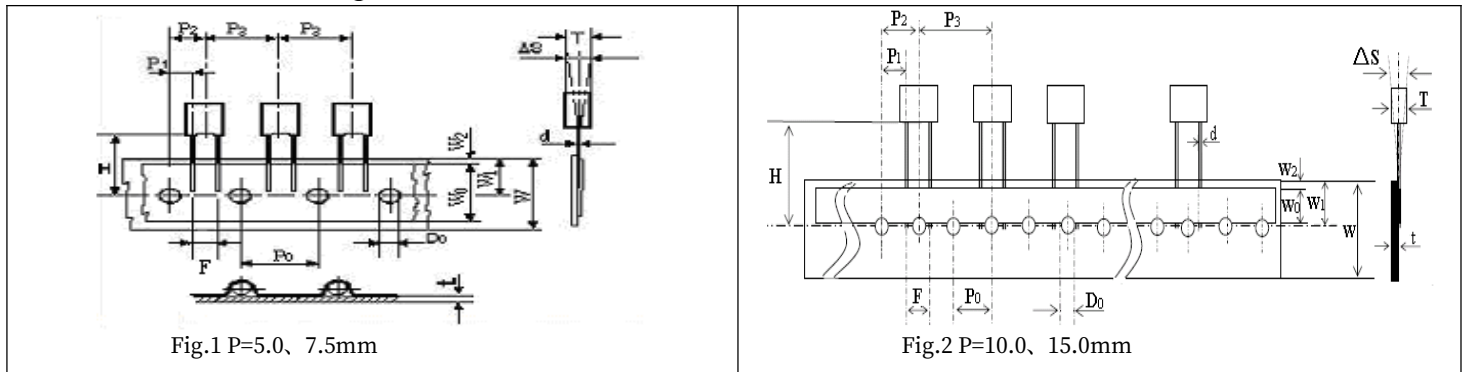
**■ Taping specification for box-type capacitors**
**▲ Outline Drawing**

**▲ Taping Dimensions(mm)**

Technology index title	Code	Dimensions				Tolerance
		P=5.0	P=7.5	P=10.0	P=15.0	
Taping type	—	Fig 1	Fig 1	Fig2	Fig 2	—
Part number Digit12-15	Ammo- pack	A201	A301	A405	A605	
Taping pitch	$P_3$	12.7	12.7	25.4	25.4	$\pm 1.0$
Feed hole pitch	$P_0$	12.7	12.7	12.7	12.7	$\pm 0.3$
Center of wire	$P_1$	3.85	2.6	7.7	5.2	$\pm 0.7$
Center of body	$P_2$	6.35	6.35	12.7	12.7	$\pm 1.3$
Pitch of taping wire	$F^{**}$	5.0	7.5	10.0	15.0	+0.6 -0.1
Component alignment	$\Delta S$	0	0	0	0	$\pm 2.0$
Height of component from tape center	$H^{***}$	18.5	18.5	18.5	18.5	$\pm 0.5$
Carrier tape width	W	18.0	18.0	18.0	18.0	+1.0 -0.5
Hold down tape width	$W_0$	6min	10min	10min	10min	—
Hole position	$W_1$	9.0	9.0	9.0	9.0	$\pm 0.5$
Hold down tape sition	$W_2$	3max	3max	3max	3max	—
Feed hole dia.	$D_0$	4.0	4.0	4.0	4.0	$\pm 0.2$
Tape thickness	t	0.7	0.7	0.7	0.7	$\pm 0.2$

**Note:** \*  $P_0=15\text{mm}$  is also available;

\*\*F can be other lead spacing;

\*\*\*H=16.5mm is available;

**■ Soldering suggestions**
**▲ Manual soldering**

Max. temperature: 350°C, time: 3s

**▲ Wave soldering**

There are many factors affecting the heating of film capacitor during the wave soldering process, such as: preheating temperature, preheating time, soldering temperature, soldering time, other heat sources influence and so on.

The typical soldering profile is as below:

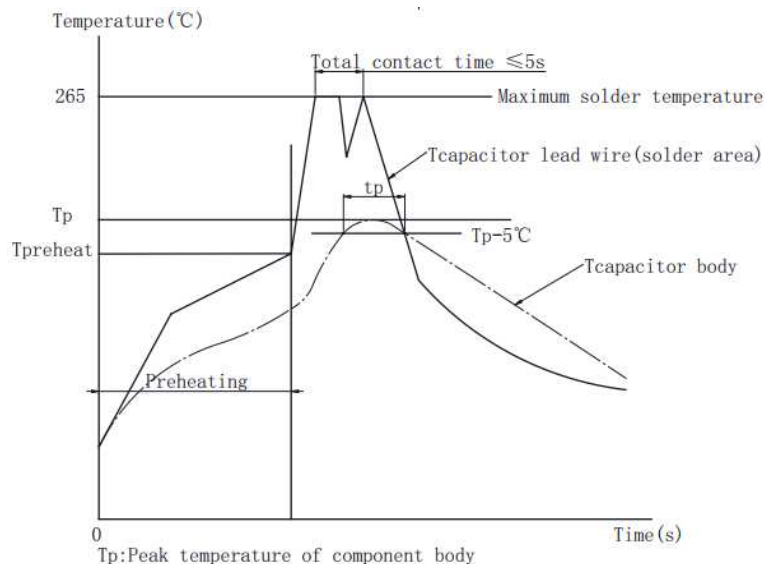

▲ Because overheating could damage the capacitor, we recommend paying attention to the maximum capacitor temperature and heating time, use temperature sensor to detect the maximum capacitor body temperature.

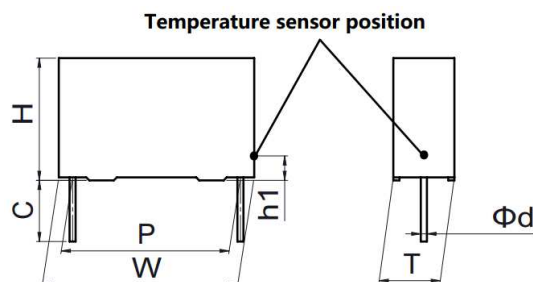

Note: If re-working or dipping twice is necessary, it should be done after the capacitor returns to the normal temperature.

Temperature sensor position (Tcapacitor body)	The capacitor body surface of lead side, capacitor height position from PCB: h1=2~3mm		
Maximum capacitor body temperature Tp(°C)	OPP film P≤15mm	OPP film P>15mm	PET film
	115	120	125
Maximum capacitor lead wire temperature (°C)	265	265	265
Maximum capacitor body heating time tp=Tp-5°C	30s		

■ Packing box sizes(mm)(example)

1. Out packing box for bulk

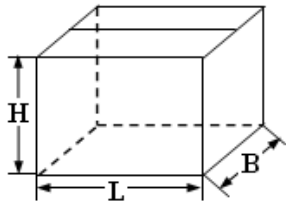

L:375±5  
B:375±5  
H:265±5

2. Inner packing box for bulk

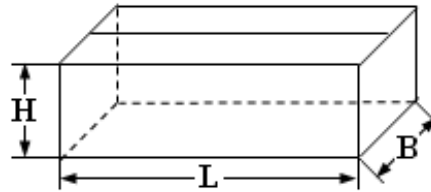

L:355±3  
B:175±3  
H:118±3

3. Box sizes for Ammo-pack

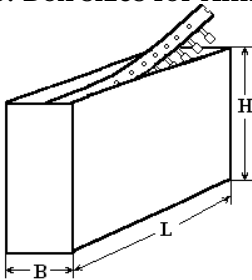

L: 350 ± 3  
B: 50 ± 3  
H: 260 ± 3

■ Storage conditions

▲ It must be noted that the solderability of the terminals may be deteriorated when stored in an atmosphere filled with moisture, dust, or a reactive oxidizing gas.(hydrogen chloride, hydrogen sulfide, sulfuric acid,etc.)

▲ It shouldn't be located in particularly high temperature and high humidity, it must submit to the following conditions(unchanging primal package):

Temperature: -40 °C to 35 °C

Humidity: Average per year ≤70%RH;

For 30 full days randomly distributed throughout the year ≤80%RH

Storage time for tinned lead wire: (from the date marked on the capacitor's body or the label glued to the package) :

Bulk(packed with plastic bag): ≤24 months ;

Taping and line up: ≤12 months

## X-ON Electronics

Largest Supplier of Electrical and Electronic Components

*Click to view similar products for [Film Capacitors](#) category:*

*Click to view products by [FARATRONIC](#) manufacturer:*

Other Similar products are found below :

[703-6G](#) [82EC1100DQ50K](#) [MMWAF150KME](#) [PCY2130F30153](#) [QXJ2E474KTPT](#) [QXL2B333KTPT](#) [QXM2G104K](#) [DPM16S56K-1F](#)  
[EEC2G505HQA406](#) [B32234-.033@250V-K](#) [B32520C6332K000](#) [B32522C6104K000](#) [B32523Q3155J](#) [B32676E6755K](#) [B81133-C1104-M3](#)  
[MTC355L1](#) [217-0716-001](#) [PA225L30](#) [CB182K0184J--](#) [KP1830-247/061-G](#) [274ACF4400WA0J](#) [SCD105K122A3-22](#) [SCD205K122A3-24](#)  
[A521HP102M400C](#) [F601BL225K063CL60A](#) [PCX2339F65224](#) [PCX2339F65334](#) [2222 368 55105](#) [2222 370 21683](#) [QXL2E473KTPT](#)  
[445450-1](#) [B32524Q6155J](#) [46KI3100JBM1K](#) [MKP 1839-215-633](#) [MKP 1840-447-165](#) [MKP383510063JKP2T0](#) [WMC08P22](#)  
[46KN410000N1K](#) [46KR368050M1M](#) [ECQ-W4223KZ](#) [EEC2G805HQA415](#) [PA103L30](#) [82DC3100DQ50J](#) [82DC4100AA60K](#)  
[82EC2150DQ50K](#) [WMF1D68](#) [PHE841ED6150MR17T0](#) [VEA105K50](#) [82EC2220DQ50J](#) [F850AG102M300C](#)