

# IGBT 吸收电容器(PCB)

## Snubber capacitor for IGBT(PCB)

### 外形图 Outline Drawing

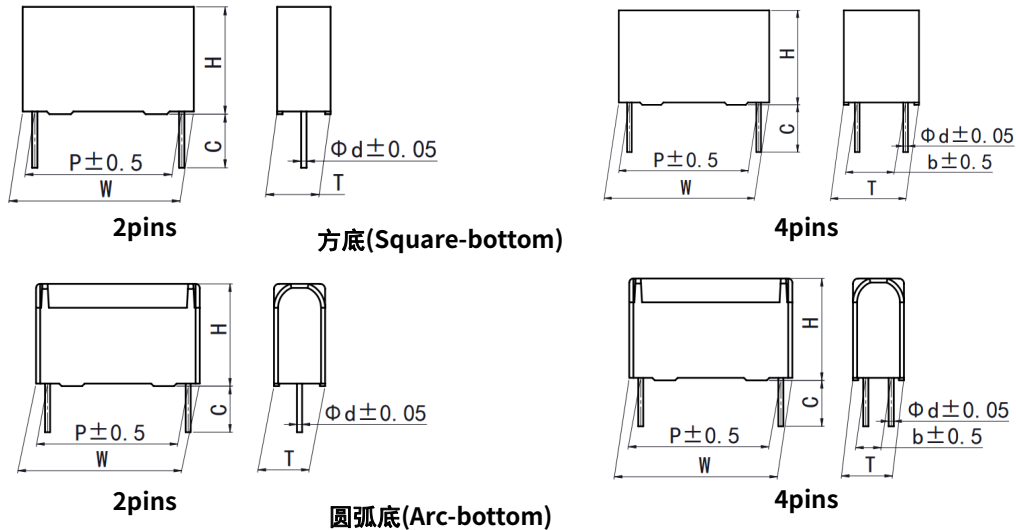

### 特点

- 广泛应用于高压高频脉冲电路中
- 损耗小，内部温升小
- 优异的阻燃性能
- 适合作为 IGBT 的吸收电容

### Features

- Widely used in high voltage, high frequency circuit
- Low loss and small inherent temperature rise
- Excellent active and passive flame resistant abilities
- Especially designed as snubber capacitor for IGBT

### 安全认证 Safety Approvals

	UL (美国)	UL 810 (construction only), Max. 5 000Vdc, 90°C 证书号 (File No.): E256238, CCN: CZDS2
--	---------	--

### 技术要求 Specifications

引用标准 Reference Standard	GB/T 17702 (IEC 61071)	
气候类别 Climatic Category	40/85/56	
工作温度(外壳) Operating Temperature Range(case)	-40°C~85°C	
额定电压( $U_{N,85^{\circ}C}$ ) Rated Voltage ( $U_{N,85^{\circ}C}$ )	630Vdc ~ 3 000Vdc	
电容量范围 Capacitance Range	0.047μF ~ 9.0μF	
电容量偏差 Capacitance Tolerance	±5% (J), ±10% (K)	
耐电压 Voltage Proof	1.5 $U_N$ (10s)	
损耗角正切 Dissipation Factor	5×10 <sup>-4</sup> (20°C, 1kHz)	
绝缘电阻 Insulation Resistance	IR≥100 000MΩ, $C_N$ ≤0.33μF IR× $C_N$ ≥30 000s, $C_N$ >0.33μF	(20°C, 100Vdc, 1min)
预期寿命 Expected lifetime	100 000h @ $U_N$ , $\theta_{hs}$ =70°C	

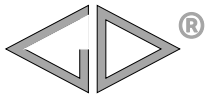

# C3H

## ■ 产品编码说明 Part number system

■ 15 位产品代码如下:

The 15 digits part number is formed as follow:

1	2	3	4	5	6	7	8	9	10	11	12	13	14	15
C	3	H												

第 1~3 位	型号代码	Digit 1 to 3	Series code
	<b>C3D</b>		<b>C3D</b>
第 4~5 位	直流额定电压	Digit 4 to 5	D.C. rated voltage
	2J=630V 1V=700V 1W=850V 3A=1 000V 3L=1 200V 1C=1 600V 7M=1 700V 3D=2 000V 3E=2 500V 4Q=3 000V		2J=630V 1V=700V 1W=850V 3A=1 000V 3L=1 200V 1C=1 600V 7M=1 700V 3D=2 000V 3E=2 500V 4Q=3 000V
第 6~8 位	标称容量	Digit 6 to 8	Rated capacitance value
	举例: 105=10×10 <sup>5</sup> pF=1.0μF		for example: 103=10×10 <sup>3</sup> pF=0.01μF
第 9 位	容量偏差	Digit 9	Capacitance tolerance
	J=±5%, K=±10%		J=±5%, K=±10%
第 10 位	引线脚距 P	Digit 10	Pitch
	D=32.5mm F=37.5mm M=52.5mm		D=32.5mm F=37.5mm M=52.5mm
第 11 位	内部特征码	Digit 11	Internal use
第 12~15 位	引线加工和包装代码	Digit 12 to 15	Lead form and packaging code

■ Table 1 引线加工和包装代码 lead form and packaging code

第 12 位 Digit 12		第 13 位和第 14 位 Digit 13 and Digit 14		第 15 位 Digit 15	
代码 Code	说明 explanation	代码 Code	说明 explanation	代码 Code	说明 explanation
0	2 引线 Two pins	C0	标准引线长度 5.5mm Standard lead length 5.5mm	0	引线长度偏差±1.0mm Length tolerance ±1.0mm
6	4 引线 Four pins b=5.0mm	38	引线长度 3.8mm Lead length 3.8mm	2	引线长度偏差±0.5mm Length tolerance ±0.5mm
2	4 引线 Four pins b=12.7mm				
3	4 引线 Four pins b=20.0mm				
A	4 引线 Four pins b=20.3mm				
B	4 引线 Four pins b=10.2mm				
C	4 引线 Four pins b=5.1mm				

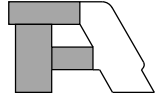

### ■ 技术参数 Technical data(mm)

630Vdc/700Vdc (420Vac) #												
C <sub>N</sub> (μF)	W ±1.0	H ±1.0	T ±1.0	P ±0.5	b ±0.5	d ±0.05	dV/dt (V/μs)	Î (A)	ESR @100kHz (mΩ)	I <sub>max</sub> 100kHz@70°C (A)	L <sub>s</sub> (nH)	Part number
0.68	37.0	25.0	15.0	32.5	—	1.2	900	612	6.0	6	23	C3H1V684+D00***
0.68	37.0	25.0	15.0	32.5	5.1	1.0	900	612	5.0	8	23	C3H1V684+D0C***
1.0	37.0	30.0	16.0	32.5	—	1.2	900	900	6.0	9	23	C3H1V105+ D00***
1.0	37.0	30.0	16.0	32.5	5.1	1.0	900	900	5.0	11	23	C3H1V105+ D0C***
1.2	37.0	30.0	16.0	32.5	—	1.2	900	1 080	5.5	11	23	C3H1V125+ D00***
1.2	37.0	30.0	16.0	32.5	5.1	1.0	900	1 080	4.5	13	23	C3H1V125+ D0C***
1.5	37.0	34.0	20.0	32.5	—	1.2	900	1 350	5.5	14	23	C3H1V155+ D00***
1.5	37.0	34.0	20.0	32.5	10.2	1.0	900	1 350	4.5	17	23	C3H1V155+ D0B***
1.8	37.0	34.0	20.0	32.5	—	1.2	900	1 620	5.5	14	23	C3H1V185+ D00***
1.8	37.0	34.0	20.0	32.5	10.2	1.0	900	1 620	4.5	18	23	C3H1V185+ D0B***
2.0	42.0	40.0	20.0	37.5	—	1.2	600	1 200	5.0	14	29	C3H1V205+ F00***
2.0	42.0	40.0	20.0	37.5	10.2	1.2	600	1 200	4.0	18	29	C3H1V205+ F0B***
2.2	42.0	40.0	20.0	37.5	—	1.2	600	1 320	5.0	14	29	C3H1V225+ F00***
2.2	42.0	40.0	20.0	37.5	10.2	1.2	600	1 320	4.0	18.5	29	C3H1V225+ F0B***
2.5	42.0	40.0	20.0	37.5	—	1.2	600	1 500	5.0	14	29	C3H1V255+ F00***
2.5	42.0	40.0	20.0	37.5	10.2	1.2	600	1 500	4.0	19	29	C3H1V255+ F0B***
3.0	42.0	44.0	24.0	37.5	—	1.2	600	1 800	5.0	14	29	C3H1V305+ F00***
3.0	42.0	44.0	24.0	37.5	12.7	1.2	600	1 800	4.0	20	29	C3H1V305+ F02***
3.3	42.0	44.0	24.0	37.5	—	1.2	600	1 980	4.5	14	29	C3H1V335+ F00***
3.3	42.0	44.0	24.0	37.5	12.7	1.2	600	1 980	3.5	20	29	C3H1V335+ F02***
4.0	42.0	44.0	24.0	37.5	—	1.2	600	2 400	4.5	14	29	C3H1V405+ F00***
4.0	42.0	44.0	24.0	37.5	12.7	1.2	600	2 400	3.5	21	29	C3H1V405+ F02***
4.7	42.0	45.0	30.0	37.5	20.3	1.2	600	2 820	3.5	23	29	C3H1V475+F0A***
5.0	42.0	45.0	30.0	37.5	20.3	1.2	600	3 000	3.0	23.5	29	C3H1V505+F0A***
★ 6.0	42.0	43.0	42.0	37.5	20.3	1.2	600	3600	3.0	25	29	C3H1V605+F0A***
★ 6.5	42.0	43.0	42.0	37.5	20.3	1.2	600	3 900	3.0	26	29	C3H1V655+F0A***
6.5	57.0	43.5	29.5	52.5	20.3	1.2	360	2 340	2.5	24	33	C3H1V655+M0A***
7.0	57.0	43.5	29.5	52.5	20.3	1.2	360	2 520	2.5	25	33	C3H1V705+M0A***
8.0	57.0	50.0	35.0	52.5	20.3	1.2	360	2 880	2.5	27	33	C3H1V805+M0A***
9.0	57.0	50.0	35.0	52.5	20.3	1.2	360	3 240	2.5	28	33	C3H1V905+M0A***

850Vdc(450Vac)												
C <sub>N</sub> (μF)	W ±1.0	H ±1.0	T ±1.0	P ±0.5	b ±0.5	d ±0.05	dV/dt (V/μs)	Î (A)	ESR @100kHz (mΩ)	I <sub>max</sub> 100kHz@70°C (A)	L <sub>s</sub> (nH)	Part number
0.47	37.0	25.0	15.0	32.5	—	1.2	1 200	564	6.0	6	23	C3H1W474+ D00***
0.47	37.0	25.0	15.0	32.5	5.1	1.0	1 200	564	5.0	8	23	C3H1W474+ D0C***
0.68	37.0	30.0	16.0	32.5	—	1.2	1 200	816	6.0	9	23	C3H1W684+ D00***
0.68	37.0	30.0	16.0	32.5	5.1	1.0	1 200	816	5.0	11	23	C3H1W684+ D0C***
1.0	37.0	34.0	20.0	32.5	—	1.2	1 200	1 200	6.0	11	23	C3H1W105+ D00***
1.0	37.0	34.0	20.0	32.5	10.2	1.0	1 200	1 200	5.0	13	23	C3H1W105+ D0B***
1.2	37.0	34.0	20.0	32.5	—	1.2	1 200	1 440	6.0	13	23	C3H1W125+ D00***
1.2	37.0	34.0	20.0	32.5	10.2	1.0	1 200	1 440	5.0	15	23	C3H1W125+ D0B***

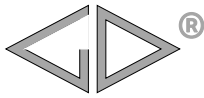

# C3H

## ■ 技术参数 Technical data(mm)

850Vdc(450Vac)												
C <sub>N</sub> (μF)	W ±1.0	H ±1.0	T ±1.0	P ±0.5	b ±0.5	d ±0.05	dV/dt (V/μs)	Î (A)	ESR @100kHz (mΩ)	I <sub>max</sub> 100kHz@70°C (A)	L <sub>s</sub> (nH)	Part number
1.5	37.0	34.0	20.0	32.5	—	1.2	1 200	1 800	6.0	14	23	C3H1W155+D00***
1.5	37.0	34.0	20.0	32.5	10.2	1.0	1 200	1 800	5.0	18	23	C3H1W155+D0B***
1.5	42.0	40.0	20.0	37.5	—	1.2	750	1 125	5.5	14	29	C3H1W155+F00***
1.5	42.0	40.0	20.0	37.5	10.2	1.2	750	1 125	4.5	18.5	29	C3H1W155+F0B***
2.0	42.0	40.0	20.0	37.5	—	1.2	750	1 500	5.5	14	29	C3H1W205+F00***
2.0	42.0	40.0	20.0	37.5	10.2	1.2	750	1 500	4.5	19	29	C3H1W205+F0B***
2.2	42.0	40.0	20.0	37.5	—	1.2	750	1 650	5.5	14	29	C3H1W225+F00***
2.2	42.0	40.0	20.0	37.5	10.2	1.2	750	1 650	4.5	19.5	29	C3H1W225+F0B***
2.5	42.0	44.0	24.0	37.5	—	1.2	750	1 875	5.5	14	29	C3H1W255+F00***
2.5	42.0	44.0	24.0	37.5	12.7	1.2	750	1 875	4.5	20	29	C3H1W255+F02***
3.0	42.0	44.0	24.0	37.5	—	1.2	750	2 250	5.5	14	29	C3H1W305+F00***
3.0	42.0	44.0	24.0	37.5	12.7	1.2	750	2 250	4.5	21	29	C3H1W305+F02***
3.3	42.0	45.0	30.0	37.5	20.3	1.2	750	2 475	4.5	21.5	29	C3H1W335+F0A***
★4.0	42.0	43.0	42.0	37.5	20.3	1.2	750	3 000	4.5	22	29	C3H1W405+F0A***
4.0	57.0	43.5	29.5	52.5	20.3	1.2	450	1 800	4.0	23	33	C3H1W405+M0A***
4.7	57.0	43.5	29.5	52.5	20.3	1.2	450	2 115	4.0	24.5	33	C3H1W475+M0A***
5.0	57.0	43.5	29.5	52.5	20.3	1.2	450	2 250	4.0	25	33	C3H1W505+M0A***
6.0	57.0	50.0	35.0	52.5	20.3	1.2	450	2 700	4.0	26	33	C3H1W605+M0A***
6.5	57.0	50.0	35.0	52.5	20.3	1.2	450	2 925	4.0	27	33	C3H1W655+M0A***

1 000Vdc(500Vac)												
C <sub>N</sub> (μF)	W ±1.0	H ±1.0	T ±1.0	P ±0.5	b ±0.5	d ±0.05	dV/dt (V/μs)	Î (A)	ESR @100kHz (mΩ)	I <sub>max</sub> 100kHz@70°C (A)	L <sub>s</sub> (nH)	Part number
0.47	37.0	25.0	15.0	32.5	—	1.2	1 300	611	6.0	6	23	C3H3A474+D00***
0.47	37.0	25.0	15.0	32.5	5.1	1.0	1 300	611	5.0	8	23	C3H3A474+D0C***
0.68	37.0	30.0	16.0	32.5	—	1.2	1 300	884	6.0	7	23	C3H3A684+D00***
0.68	37.0	30.0	16.0	32.5	5.1	1.0	1 300	884	5.0	9	23	C3H3A684+D0C***
0.82	37.0	30.0	16.0	32.5	—	1.2	1 300	1 066	6.0	9	23	C3H3A824+D00***
0.82	37.0	30.0	16.0	32.5	5.1	1.0	1 300	1 066	5.0	11	23	C3H3A824+D0C***
1.0	37.0	34.0	20.0	32.5	—	1.2	1 300	1 300	5.5	12	23	C3H3A105+D00***
1.0	37.0	34.0	20.0	32.5	10.2	1.0	1 300	1 300	4.5	14	23	C3H3A105+D0B***
1.2	37.0	34.0	20.0	32.5	—	1.2	1 300	1 560	5.5	14	23	C3H3A125+D00***
1.2	37.0	34.0	20.0	32.5	10.2	1.0	1 300	1 560	4.5	17	23	C3H3A125+D0B***
1.2	42.0	40.0	20.0	37.5	—	1.2	850	1 020	5.5	14	29	C3H3A125+F00***
1.2	42.0	40.0	20.0	37.5	10.2	1.2	850	1 020	4.5	16	29	C3H3A125+F0B***
1.5	42.0	40.0	20.0	37.5	—	1.2	850	1 275	5.5	14	29	C3H3A155+F00***
1.5	42.0	40.0	20.0	37.5	10.2	1.2	850	1 275	4.5	16	29	C3H3A155+F0B***
2.0	42.0	44.0	24.0	37.5	—	1.2	850	1 700	5.5	14	29	C3H3A205+F00***
2.0	42.0	44.0	24.0	37.5	12.7	1.2	850	1 700	4.5	17	29	C3H3A205+F02***

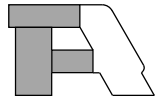
**■ 技术参数 Technical data(mm)**

1 000Vdc(500Vac)												
C <sub>N</sub> (μF)	W ±1.0	H ±1.0	T ±1.0	P ±0.5	b ±0.5	d ±0.05	dV/dt (V/μs)	Î (A)	ESR @100kHz (mΩ)	I <sub>max</sub> 100kHz@70°C (A)	L <sub>s</sub> (nH)	Part number
2.2	42.0	44.0	24.0	37.5	—	1.2	850	1 870	5.0	14	29	C3H3A225+ F00***
2.2	42.0	44.0	24.0	37.5	12.7	1.2	850	1 870	4.0	20	29	C3H3A225+ F02***
2.5	42.0	45.0	30.0	37.5	20.3	1.2	850	2 125	4.0	21	29	C3H3A255+ F0A***
3.0	42.0	45.0	30.0	37.5	20.3	1.2	850	2 550	4.0	21.5	29	C3H3A305+ F0A***
★ 3.3	42.0	43.0	42.0	37.5	20.3	1.2	850	2 805	4.0	22	29	C3H3A335+ F0A***
3.3	57.0	43.5	29.5	52.5	20.3	1.2	500	1 650	4.0	20	33	C3H3A335+ M0A***
4.0	57.0	43.5	29.5	52.5	20.3	1.2	500	2 000	4.0	21	33	C3H3A405+ M0A***
4.7	57.0	50.0	35.0	52.5	20.3	1.2	500	2 350	4.0	22	33	C3H3A475+ M0A***
5.0	57.0	50.0	35.0	52.5	20.3	1.2	500	2 500	4.0	23	33	C3H3A505+ M0A***

1 200Vdc(600Vac)												
C <sub>N</sub> (μF)	W ±1.0	H ±1.0	T ±1.0	P ±0.5	b ±0.5	d ±0.05	dV/dt (V/μs)	Î (A)	ESR @100kHz (mΩ)	I <sub>max</sub> 100kHz@70°C (A)	L <sub>s</sub> (nH)	Part number
0.33	37.0	25.0	15.0	32.5	—	1.2	1 500	495	6.5	6	23	C3H3L334+ D00***
0.33	37.0	25.0	15.0	32.5	5.1	1.0	1 500	495	5.5	8	23	C3H3L334+ D0C***
0.47	37.0	30.0	16.0	32.5	—	1.2	1 500	705	6.5	8	23	C3H3L474+ D00***
0.47	37.0	30.0	16.0	32.5	5.1	1.0	1 500	705	5.5	10	23	C3H3L474+ D0C***
0.68	37.0	34.0	20.0	32.5	—	1.2	1 500	1 020	6.5	9	23	C3H3L684+ D00***
0.68	37.0	34.0	20.0	32.5	10.2	1.0	1 500	1 020	5.5	11	23	C3H3L684+ D0B***
0.75	37.0	34.0	20.0	32.5	—	1.2	1 500	1 125	6.5	10	23	C3H3L754+ D00***
0.75	37.0	34.0	20.0	32.5	10.2	1.0	1 500	1 125	5.5	12	23	C3H3L754+ D0B***
0.82	42.0	40.0	20.0	37.5	—	1.2	950	779	6.0	11	29	C3H3L824+ F00***
0.82	42.0	40.0	20.0	37.5	10.2	1.2	950	779	5.0	13	29	C3H3L824+ F0B***
1.0	42.0	40.0	20.0	37.5	—	1.2	950	950	6.0	13	29	C3H3L105+ F00***
1.0	42.0	40.0	20.0	37.5	10.2	1.2	950	950	5.0	15	29	C3H3L105+ F0B***
1.2	42.0	44.0	24.0	37.5	—	1.2	950	1 140	5.5	14	29	C3H3L125+ F00***
1.2	42.0	44.0	24.0	37.5	12.7	1.2	950	1 140	4.5	17	29	C3H3L125+ F02***
1.5	42.0	44.0	24.0	37.5	—	1.2	950	1 425	5.5	14	29	C3H3L155+ F00***
1.5	42.0	44.0	24.0	37.5	12.7	1.2	950	1 425	4.5	17.5	29	C3H3L155+ F02***
2.0	42.0	45.0	30.0	37.5	20.3	1.2	950	1 900	4.5	18	29	C3H3L205+ F0A***
★ 2.2	42.0	43.0	42.0	37.5	20.3	1.2	950	2 090	4.5	19	29	C3H3L225+ F0A***
★ 2.5	42.0	43.0	42.0	37.5	20.3	1.2	950	2 375	4.5	20	29	C3H3L255+ F0A***
2.2	57.0	43.5	29.5	52.5	20.3	1.2	600	1 320	4.0	18	33	C3H3L225+ M0A***
2.5	57.0	43.5	29.5	52.5	20.3	1.2	600	1 500	4.0	19	33	C3H3L255+ M0A***
3.0	57.0	50.0	35.0	52.5	20.3	1.2	600	1 800	4.0	20	33	C3H3L305+ M0A***
3.3	57.0	50.0	35.0	52.5	20.3	1.2	600	1 980	4.0	21	33	C3H3L335+ M0A***
3.5	57.0	50.0	35.0	52.5	20.3	1.2	600	2 400	4.0	22	33	C3H3L355+ M0A***

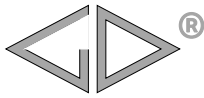

# C3H

## ■ 技术参数 Technical data(mm)

1 600Vdc(650Vac)												
C <sub>N</sub> (μF)	W ±1.0	H ±1.0	T ±1.0	P ±0.5	b ±0.5	d ±0.05	dV/dt (V/μs)	İ (A)	ESR @100kHz (mΩ)	I <sub>max</sub> 100kHz@70°C (A)	L <sub>s</sub> (nH)	Part number
0.22	37.0	25.0	15.0	32.5	—	1.2	1900	418	7.5	6	23	C3H3C224+ D00***
0.22	37.0	25.0	15.0	32.5	5.1	1.0	1900	418	6.5	7	23	C3H3C224+ D0C***
0.33	37.0	30.0	16.0	32.5	—	1.2	1900	627	7.5	7.5	23	C3H3C334+ D00***
0.33	37.0	30.0	16.0	32.5	5.1	1.0	1900	627	6.5	9	23	C3H3C334+ D0C***
0.39	37.0	33.0	18.0	32.5	—	1.2	1900	741	7.0	9	23	C3H3C394+ D00***
0.39	37.0	33.0	18.0	32.5	5.1	1.0	1900	741	6.0	11	23	C3H3C394+ D0C***
0.47	37.0	34.0	20.0	32.5	—	1.2	1900	893	7.0	11	23	C3H3C474+ D00***
0.47	37.0	34.0	20.0	32.5	10.2	1.0	1900	893	6.0	13	23	C3H3C474+ D0B***
0.68	42.0	40.0	20.0	37.5	—	1.2	1250	850	4.0	14	29	C3H3C684+ F00***
0.68	42.0	40.0	20.0	37.5	10.2	1.2	1250	850	4.0	16	29	C3H3C684+ F0B***
0.82	42.0	44.0	24.0	37.5	—	1.2	1250	1025	4.0	14	29	C3H3C824+ F00***
0.82	42.0	44.0	24.0	37.5	12.7	1.2	1250	1025	4.0	17	29	C3H3C824+ F02***
1.0	42.0	45.0	30.0	37.5	20.3	1.2	1250	1250	4.0	17.5	29	C3H3C105+ F0A***
1.2	42.0	45.0	30.0	37.5	20.3	1.2	1250	1500	4.0	18	29	C3H3C125+ F0A***
★1.5	42.0	43.0	42.0	37.5	20.3	1.2	1250	1875	4.0	19	29	C3H3C155+ F0A***
1.5	57.0	43.5	29.5	52.5	20.3	1.2	750	1125	4.0	20	33	C3H3C155+ M0A***
2.0	57.0	50.0	35.0	52.5	20.3	1.2	750	1500	4.0	22	33	C3H3C205+ M0A***

1 700Vdc(675Vac)												
C <sub>N</sub> (μF)	W ±1.0	H ±1.0	T ±1.0	P ±0.5	b ±0.5	d ±0.05	dV/dt (V/μs)	İ (A)	ESR @100kHz (mΩ)	I <sub>max</sub> 100kHz@70°C (A)	L <sub>s</sub> (nH)	Part number
0.15	37.0	25.0	15.0	32.5	—	1.2	2000	300	8.5	5	23	C3H7M154+ D00***
0.15	37.0	25.0	15.0	32.5	5.1	1.0	2000	300	7.5	6	23	C3H7M154+ D0C***
0.22	37.0	30.0	16.0	32.5	—	1.2	2000	440	7.5	6	23	C3H7M224+ D00***
0.22	37.0	30.0	16.0	32.5	5.1	1.0	2000	440	6.5	8	23	C3H7M224+ D0C***
0.33	37.0	34.0	20.0	32.5	—	1.2	2000	660	7.0	9	23	C3H7M334+ D00***
0.33	37.0	34.0	20.0	32.5	10.2	1.0	2000	660	6.0	10.5	23	C3H7M334+ D0B***
0.39	37.0	34.0	20.0	32.5	—	1.2	2000	780	7.0	10	23	C3H7M394+ D00***
0.39	37.0	34.0	20.0	32.5	10.2	1.0	2000	780	6.0	12	23	C3H7M394+ D0B***
0.47	42.0	36.0	24.0	37.5	—	1.2	1260	592	6.0	12	29	C3H7M474+ F00***
0.47	42.0	36.0	24.0	37.5	12.7	1.2	1260	592	5.0	14	29	C3H7M474+ F02***
0.56	42.0	36.0	24.0	37.5	—	1.2	1260	706	6.0	13	29	C3H7M564+ F00***
0.56	42.0	36.0	24.0	37.5	12.7	1.2	1260	706	5.0	15	29	C3H7M564+ F02***
0.68	42.0	44.0	24.0	37.5	—	1.2	1260	857	6.0	14	29	C3H7M684+ F00***
0.68	42.0	44.0	24.0	37.5	12.7	1.2	1260	857	6.0	16	29	C3H7M684+ F02***
0.82	42.0	44.0	24.0	37.5	—	1.2	1260	1033	5.5	14	29	C3H7M824+ F00***
0.82	42.0	44.0	24.0	37.5	12.7	1.2	1260	1033	4.5	17	29	C3H7M824+ F02***
1.0	42.0	45.0	30.0	37.5	20.3	1.2	1260	1260	4.5	18	29	C3H7M105+ F0A***
★1.2	42.0	43.0	42.0	37.5	20.3	1.2	1260	1512	4.5	19	29	C3H7M125+ F0A***
1.0	57.0	45.0	25.0	52.5	20.3	1.2	780	780	4.0	16	33	C3H7M105+ M0A***
1.2	57.0	43.5	29.5	52.5	20.3	1.2	780	936	4.0	17	33	C3H7M125+ M0A***
1.5	57.0	43.5	29.5	52.5	20.3	1.2	780	1170	4.0	20	33	C3H7M155+ M0A***
2.0	57.0	50.0	35.0	52.5	20.3	1.2	780	1560	4.0	22	33	C3H7M205+ M0A***

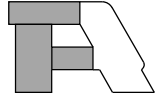
**■ 技术参数 Technical data(mm)**

2 000Vdc(700Vac)												
C <sub>N</sub> (μF)	W ±1.0	H ±1.0	T ±1.0	P ±0.5	b ±0.5	d ±0.05	dV/dt (V/μs)	Î (A)	ESR @100kHz (mΩ)	I <sub>max</sub> 100kHz@70°C (A)	L <sub>s</sub> (nH)	Part number
0.10	37.0	25.0	15.0	32.5	—	1.2	2 241	224	9.5	5	23	C3H3D104+ D00***
0.10	37.0	25.0	15.0	32.5	5.1	1.0	2 241	224	8.5	6	23	C3H3D104+ D0C***
0.15	37.0	25.0	15.0	32.5	—	1.2	2 241	336	9.5	6	23	C3H3D154+ D00***
0.15	37.0	25.0	15.0	32.5	5.1	1.0	2 241	336	8.5	8	23	C3H3D154+ D0C***
0.22	37.0	30.0	16.0	32.5	—	1.2	2 241	493	7.5	7.5	23	C3H3D224+ D00***
0.22	37.0	30.0	16.0	32.5	5.1	1.0	2 241	493	6.5	9	23	C3H3D224+ D0C***
0.33	37.0	34.0	20.0	32.5	—	1.2	2 241	740	7.5	10	23	C3H3D334+ D00***
0.33	37.0	34.0	20.0	32.5	10.2	1.0	2 241	740	6.5	12	23	C3H3D334+ D0B***
0.47	42.0	40.0	20.0	37.5	—	1.2	1 300	611	6.0	13	29	C3H3D474+ F00***
0.47	42.0	40.0	20.0	37.5	10.2	1.2	1 300	611	5.0	15	29	C3H3D474+ F0B***
0.56	42.0	44.0	24.0	37.5	—	1.2	1 300	728	6.0	14	29	C3H3D564+ F00***
0.56	42.0	44.0	24.0	37.5	12.7	1.2	1 300	728	5.0	16	29	C3H3D564+ F02***
0.68	42.0	44.0	24.0	37.5	—	1.2	1 300	884	5.5	14	29	C3H3D684+ F00***
0.68	42.0	44.0	24.0	37.5	12.7	1.2	1 300	884	4.5	16.5	29	C3H3D684+ F02***
0.82	42.0	45.0	30.0	37.5	20.3	1.2	1 300	1 066	4.5	17	29	C3H3D824+ F0A***
1.0	42.0	43.0	42.0	37.5	20.3	1.2	1 300	1 300	4.5	19	29	C3H3D105+ F0A***
1.0	57.0	43.5	29.5	52.5	20.3	1.2	850	850	4.5	20	33	C3H3D105+ M0A***
1.2	57.0	43.5	29.5	52.5	20.3	1.2	850	1 020	4.5	21	33	C3H3D125+ M0A***
1.5	57.0	50.0	35.0	52.5	20.3	1.2	850	1 275	4.5	22	33	C3H3D155+ M0A***

2 500Vdc(725Vac)												
C <sub>N</sub> (μF)	W ±1.0	H ±1.0	T ±1.0	P ±0.5	b ±0.5	d ±0.05	dV/dt (V/μs)	Î (A)	ESR @100kHz (mΩ)	I <sub>max</sub> 100kHz@70°C (A)	L <sub>s</sub> (nH)	Part number
0.068	37.0	25.0	15.0	32.5	—	1.2	3 230	220	10.0	5	23	C3H3E683+ D00***
0.068	37.0	25.0	15.0	32.5	5.1	1.0	3 230	220	9.0	6	23	C3H3E683+ D0C***
0.10	37.0	30.0	16.0	32.5	—	1.2	3 230	323	10.0	6	23	C3H3E104+ D00***
0.10	37.0	30.0	16.0	32.5	5.1	1.0	3 230	323	9.0	7	23	C3H3E104+ D0C***
0.15	37.0	34.0	20.0	32.5	—	1.2	3 230	485	9.5	8	23	C3H3E154+ D00***
0.15	37.0	34.0	20.0	32.5	10.2	1.0	3 230	485	8.5	10	23	C3H3E154+ D0B***
0.18	37.0	34.0	20.0	32.5	—	1.2	3 230	581	9.0	10.5	23	C3H3E184+ D00***
0.18	37.0	34.0	20.0	32.5	10.2	1.0	3 230	581	8.0	12	23	C3H3E184+ D0B***
0.22	42.0	40.0	20.0	37.5	—	1.2	2 100	462	5.5	11	29	C3H3E224+ F00***
0.22	42.0	40.0	20.0	37.5	10.2	1.2	2 100	462	4.5	13	29	C3H3E224+ F0B***
0.33	42.0	44.0	24.0	37.5	—	1.2	2 100	693	5.5	13	29	C3H3E334+ F00***
0.33	42.0	44.0	24.0	37.5	12.7	1.2	2 100	693	4.5	15.2	29	C3H3E334+ F02***
0.47	42.0	45.0	30.0	37.5	20.3	1.2	2 100	987	4.0	16	29	C3H3E474+ F0A***
★0.68	42.0	43.0	42.0	37.5	20.3	1.2	2 100	1428	4.0	16.5	29	C3H3E684+ F0A***
0.68	57.0	43.5	29.5	52.5	20.3	1.2	1 200	816	4.0	17	33	C3H3E684+ M0A***
1.0	57.0	50.0	35.0	52.5	20.3	1.2	1 200	1 200	4.0	17.5	33	C3H3E105+ M0A***

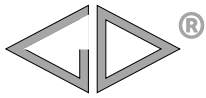

# C3H

## ■ 技术参数 Technical data(mm)

3 000Vdc(750Vac)												
C <sub>N</sub> (μF)	W ±1.0	H ±1.0	T ±1.0	P ±0.5	b ±0.5	d ±0.05	dV/dt (V/μs)	Î (A)	ESR @100kHz (mΩ)	I <sub>max</sub> 100kHz@70°C (A)	L <sub>s</sub> (nH)	Part number
0.047	37.0	25.0	15.0	32.5	—	1.2	3 361	158	10.5	5.5	23	C3H4Q473+ D00***
0.047	37.0	25.0	15.0	32.5	5.1	1.0	3 361	158	9.5	7	23	C3H4Q473+ D0C***
0.068	37.0	30.0	16.0	32.5	—	1.2	3 361	229	10.0	6	23	C3H4Q683+ D00***
0.068	37.0	30.0	16.0	32.5	5.1	1.0	3 361	229	9.0	8	23	C3H4Q683+ D0C***
0.10	37.0	34.0	20.0	32.5	—	1.2	3 361	336	9.5	8	23	C3H4Q104+ D00***
0.10	37.0	34.0	20.0	32.5	10.2	1.0	3 361	336	8.5	10	23	C3H4Q104+ D0B***
0.15	37.0	34.0	20.0	32.5	—	1.2	3 361	504	9.0	9	23	C3H4Q154+ D00***
0.15	37.0	34.0	20.0	32.5	10.2	1.0	3 361	504	8.0	11	23	C3H4Q154+ D0B***
0.22	42.0	40.0	20.0	37.5	—	1.2	2 050	451	7.0	10	29	C3H4Q224+ F00***
0.22	42.0	40.0	20.0	37.5	10.2	1.2	2 050	451	6.0	12	29	C3H4Q224+ F0B***
0.33	42.0	45.0	30.0	37.5	20.3	1.2	2 050	677	5.5	14.5	29	C3H4Q334+ F0A***
★0.47	42.0	43.0	42.0	37.5	20.3	1.2	2 050	964	5.0	16	29	C3H4Q474+ F0A***
0.47	57.0	43.5	29.5	52.5	20.3	1.2	1 200	564	5.0	16.5	33	C3H4Q474+ M0A***
0.68	57.0	50.0	35.0	52.5	20.3	1.2	1 200	816	5.0	17	33	C3H4Q684+ M0A***
0.82	57.0	50.0	35.0	52.5	20.3	1.2	1 200	984	4.5	18	33	C3H4Q824+ M0A***

备注 Note: 1. “+” 表示容量偏差。 “+” =capacitance tolerance code, J=±5%, K=±10%.

2. “\*\*\*” 表示引线加工和包装代码。 “\*\*\*” = lead form and packaging code.

3. “#” 当额定电压为 630Vdc时, 第 4~5 位为 2J。 “#” when the rated voltage is 630Vdc, the digit 4~5 is 3J.

4. 当 “b=5.0mm” 时, 第 12 位代码为 “6”; 当 “b=10.0mm” 时, 第 12 位代码为 “1”; 当 “b=20.0mm” 时, 第 12 位代码为 “3”。

When the b=5.0mm, the digit 12 is “6”; When the b=10.0mm, the digit 12 is “1”; When the b=20.0mm, the digit 12 is “3”.

5. “I<sub>max</sub>” 测试条件: 环境温度 70°C, 频率 100kHz, 外壳温度达到 85°C下的有效值。

“I<sub>max</sub>” at 10kHz, θ<sub>amb</sub>=70°C, Δθ<sub>case</sub>=15.0°C.

6. “ESR”、“L<sub>s</sub>” 均为典型值。 “ESR”, “L<sub>s</sub>” are typical values.

7. “★” 表示外壳为圆弧底。 “★” = Arc-bottom of the outer shell.



## X-ON Electronics

Largest Supplier of Electrical and Electronic Components

*Click to view similar products for [Safety Capacitors](#) category:*

*Click to view products by [FARATRONIC](#) manufacturer:*

Other Similar products are found below :

[B32022B3223K026](#) [B32912A3104K026](#) [B81123C1102M003](#) [MKPY2-.02230020P15](#) [46KN333000M1M](#) [46KN422000P0M](#)  
[46KR422000M1K](#) [MP1125KRE6RLC](#) [MP2683KGC2XLC](#) [MP2124KGC3XLC](#) [MP2684KGD4XLC](#) [MP2474KGE1XLC](#) [46KF268000M1M](#)  
[46KI3150NDM2M](#) [PHE840MD6220MD13R30](#) [PHE840MY6470MD14R06](#) [PHE845VD5470MR06](#) [R463N4100ZAM1K](#) [MKPX2R-](#)  
[1/400/10P27](#) [YP500101K040B20C2P](#) [YU0AH222M090DAMD0B](#) [LS1808N102K302NX080TM](#) [CY1471KE1IEB46X2A2](#)  
[CY1222ME5IEE48O2A2](#) [MPX474K31DTEV158G0](#) [Y2560K-D1I-B4-AC250V](#) [HMF222MG3BW](#) [CY1471ME19EE45W2A2](#)  
[MPX104K31D2KN158HF](#) [MPX224K31D2KN158G0](#) [PX104K2W1502](#) [MP2224K32C5J6LC](#) [H102M050FQ55250L750A](#)  
[MP2474K32D6R8LC](#) [MP2224K32C3J6LC](#) [MP2104K32C3J6LC](#) [PX334K2C1006](#) [YU0AC222M080L20C7B](#) [MP2473K27B2X6LC](#)  
[MP2224K32D4J8LC](#) [MP2684K32D6T8LC](#) [ST3Y1Y5U332M500VAC](#) [ST3Y1Y5V472M500VAC](#) [MP2474K32D4X8LC](#)  
[MP2474K32D4J8LC](#) [YU0AH332M110L4EB0B](#) [CY1681ME1IEE45S2A2](#) [Y1220J-E1I-B4-AC400V](#) [Y1120K-E1I-B4-AC400V](#)  
[MP2154K32D2R8LC](#)