



SPECIFICATION FOR APPROVAL

File No.: O/FRK 0.GS.E.C42-C14

Product Name Box-type Metallized Polypropylene Film Interference Suppression Capacitor (Class X2)

Product Type MKP62

Product Code C42

Customer

Customer Code

Issue Date

Xiamen Faratronic Co. Ltd.			Approved by Customer
Drafted	Checked	Approved	



厦门法拉电子股份有限公司

Xiamen Faratronic Co. Ltd.

地址: 中国厦门市海沧区新园路 99 号

Add: No.99 Xinyuan Road, Haicang District, Xiamen, China

Export business HK office : **Faratronic (HK) Co. Ltd.**

TEL: 0086-592-6208609 6208608 0852-2898 9168

FAX: 0086-592-6208557 0852-2898 9683

Mail: Vivian@faratronic.com.cn hkoffice@faratronic.com.hk

Donny@faratronic.com.cn kolin@faratronic.com.hk

james@faratronic.com.cn

Http: www.faratronic.com.cn www.faratronic.com

*.The specification are the property of Xiamen Faratronic Co.Ltd and shall not be copied or used as commercial purposes without permission.

Version history

Current version	Date	Author	Change description

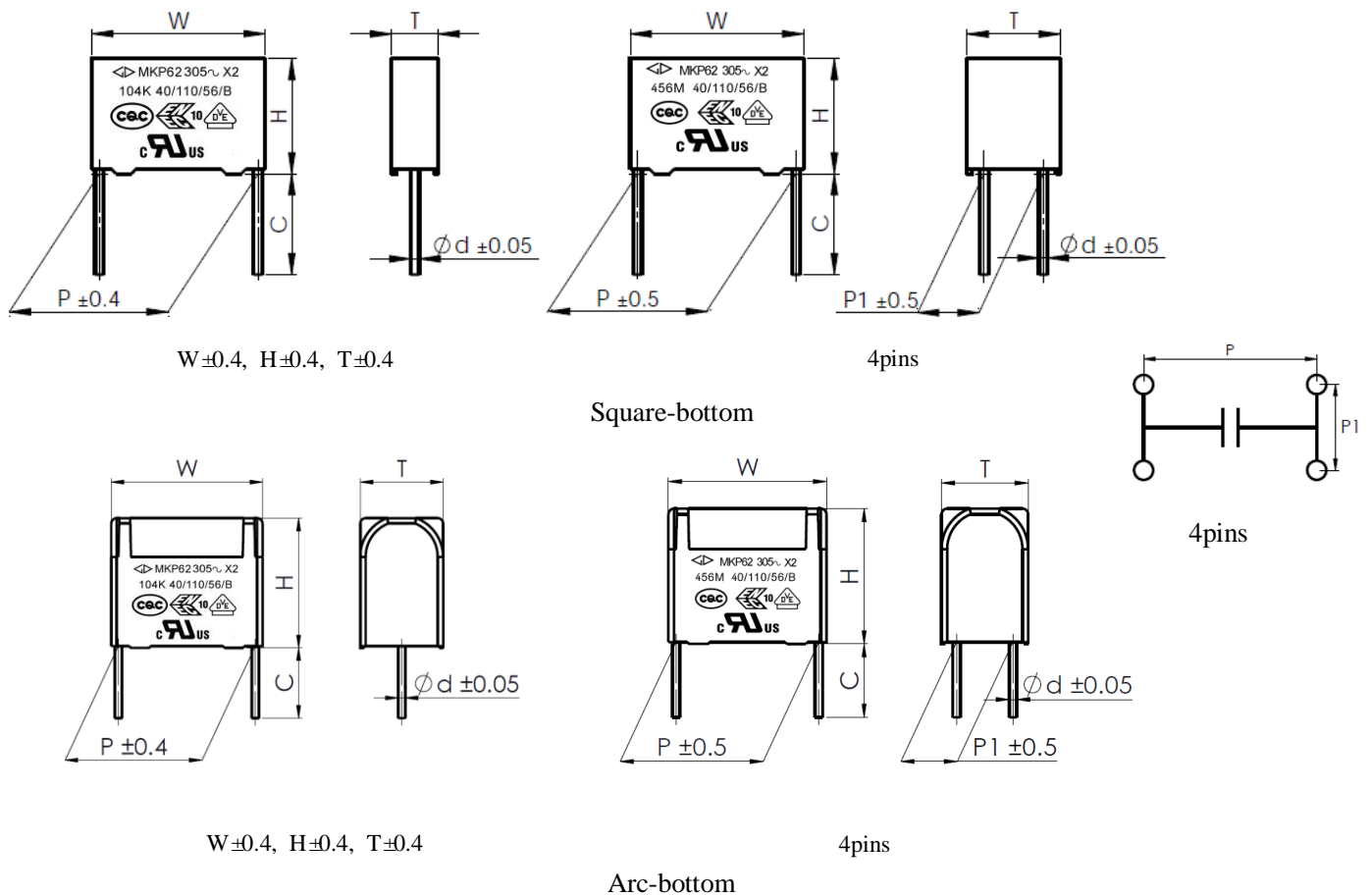
Metallized polypropylene film interference suppression capacitor(Class X2, 305Vac/275Vac)
■ Outline Drawing

■ Features

- Metallized polypropylene structure
- Withstanding overvoltage stressing
- Excellent active and passive flame resistant abilities
- Used in across-the-line, interference suppression circuit.

■ Safety Approvals

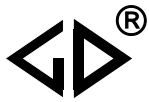
●		CQC	IEC 60384-14:2013, X2, 305Vac/275Vac, 0.0010μF~50.0μF, 40/110/56/B Certificate No.: CQC03001002875
●		ENEC-VDE	EN 60384-14:2013, X2, 305Vac/275Vac, 0.0010μF~50.0μF, 40/110/56/B Certificate No.: 40000358
●		UL-CUL	UL 60384-14:2009, CSA E60384-14:09, X2, 305Vac/275Vac, 0.0010μF~50.0μF, 40/110/56/B File No.: E186600, CCN: FOWX2/8
●		KC	K60384-14(2006-12), X2, 305Vac/275Vac, 0.0010μF~3.0μF, 40/110/56/B Certificate No.: SU03060-12001A/12002/12003/12004



■ Specifications

Class	Class X2		
Climatic Category / Passive Flammability	40/110/56/B		
Operating Temperature Range	-40°C ~ +110°C		
Rated Voltage (U _R)	305Vac/275Vac, 50/60Hz		
Maximum continuous DC voltage	630Vdc		
Capacitance Range	0.0010μF~25.0μF		
Capacitance Tolerance	±10%(K), ±20%(M)		
Voltage Proof	Between Terminals	4.3U _R (dc), 2s	
	Between Terminals To Case	2 120Vac, 1min	
Insulation Resistance	R≥15 000MΩ, C _N ≤0.33μF RC _N ≥5 000s, C _N >0.33μF (20°C, 100V, 1min)		
Dissipation Factor	0.0010μF≤C _N <0.010μF	≤20×10 ⁻⁴ (1kHz,20°C)	≤20×10 ⁻⁴ (10kHz,20°C)
	0.010μF≤C _N <0.47μF	≤10×10 ⁻⁴ (1kHz,20°C)	≤20×10 ⁻⁴ (10kHz,20°C)
	0.47μF≤C _N ≤1.0μF	≤20×10 ⁻⁴ (1kHz,20°C)	≤40×10 ⁻⁴ (10kHz,20°C)
	1.0μF<C _N ≤10.0μF	≤30×10 ⁻⁴ (1kHz,20°C)	-----
	10.0μF<C _N ≤50.0μF	≤40×10 ⁻⁴ (1kHz,20°C)	-----

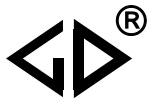

■ Part number system

The 18 digits part number is formed as follow:

1	2	3	4	5	6	7	8	9	10	11	12	13	14	15	16	17	18
C	4	2															

Digit 1 to 3 Series code

C42=MKP62

Digit 4 to 5 A.C. rated voltage

Q2=305V P2=275V

Digit 6 to 8 Rated capacitance value

For example : 103=10×10³ pF= 0.01μF

Digit 9 Capacitance tolerance

K=±10%, M=±20%

Digit 10 Pitch

3=7.5mm 4=10.0mm 6=15.0mm 9=22.5mm

B=27.5mm F=37.5mm M=52.5mm

Digit 11 Internal use

Digit 12 to 15 Lead form and packaging code

Digit 16 to 18 Internal use

Table1 Lead form and packaging code

Digit 12		Digit 13		Digit 14		Digit 15	
code	explanation	code	explanation	code	explanation	code	explanation
A	ammo-pack	3 4 6	F=7.5mm F=10.0mm F=15.0mm	0	Straight	1 5	each cap. among two consecutive holes P3=12.7mm,H=18.5mm (For P=7.5mm) P3=25.4mm;H=18.5mm (For pitch=10/15mm) (Detail parameter refer to page 11)
C	straight lead “C” in the figure above	code	explanation			0	Length tolerance ±0.5mm or standard length
		00	standard lead length (18mm~26mm)			2	Length tolerance ±0.3mm
		45	lead length 4.5mm				
		35	lead length 3.5mm				
		32	lead length 3.2mm				
D	Insulated stranded leads	C5	35mm			1	Length tolerance -5 mm~0 mm
E	Insulated solid leads	K0	100mm			2	Length tolerance 0 mm~+5 mm
M	Insulated stranded leads Box with mounting foot	K2	120mm			3	Length tolerance 0 mm~+10mm
		L0	200mm			4	Length tolerance ±5 mm
T	P1=20.3mm±0.5mm	45	lead length 4.5mm			0	Length tolerance ±0.5mm or standard length
3	P1=20mm±0.5mm	55	lead length 5.5mm				

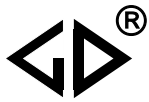

Dimensions(mm)

Table with columns for dimensions (Cn, W, H, T, P, d) and part numbers for 305Vac/275Vac# capacitors. The table is organized into three main sections, each with a header row for dimensions and part numbers. The first section covers part numbers from C42Q2102-30 to C42Q2183-6A. The second section covers C42Q2223-6A to C42Q2334-6C. The third section covers C42Q2394-6S to C42Q2225-9A. Each row includes specific dimensions and a corresponding part number.

- Note: 1. "-"=capacitance tolerance code, M=±20%, K=±10%
2. "***"=lead form and packaging mode code (refer to table 1)
3. "# when the rated voltage is 275Vac, the digit 4~5 is P2.
4. Not for use in series with the mains, the capacitors for series with the mains please refer to A.C. Capacitors for Capacitive Divider.
5. "★" = Arc bottom of the outer shell.

■ Maximum permissible voltage change per unit of time

Rated Voltage (Vac)	dV/dt(V/us) at 440 Vdc						
	P=7.5mm	P=10mm	P=15mm	P=22.5mm	P=27.5mm	P=37.5mm	P=52.5mm
305	500	500	400	200	150	100	50

Note:

1. Rated voltage pulse slope $(dV/dt)_R$ at rated voltage.
2. If the working voltage(U) is lower than the rated voltage(U_R),the capacitor can be worked at a higher dV/dt. In this case, the maximum allowed dV/dt is obtain by multiplying the right value with U_R/U .

■ Impedance Vs. Frequency

TYPICAL GRAPHS

Z=f(f) Typical values

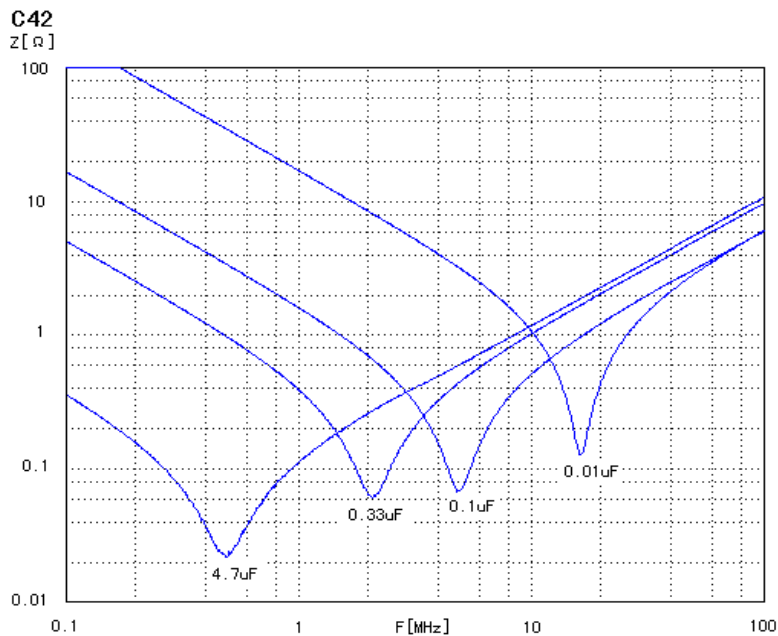

■ Quality ensuring test (before shipment):

Inspection item (each batch)	Inspection level (GB/T 2828.1, ISO2859-1)	
	IL	AQL
Appearance inspection	II	1.5%
Dimensions		
Capacitance	II	0.25%
Tangent of the loss angle		
Dielectric strength		
Insulation resistance		
Solderability	S-3	2.5%

■ Test Method And Performance

No.	Item	Performance	Test Method (IEC 60384-14)
1	4.5 Solderability	Good quality of tinning	Solder temperature: 245°C ±5°C Immersion time: 2.0s±0.5s
2	4.3 Terminal strength	There shall be no visible damage	Tense: 0.50<d≤0.80, 10N 0.80<d≤1.25, 20N Bend: 0.50<d≤0.80, 5N 0.80<d≤1.25, 10N The terminals shall be bent 2 times in each direction
3	4.4 Resistance to solder heat	There shall be no visible damage $\Delta C/C \leq \pm 5\%$ (relative to the initial value)	Solder temperature: 260°C ±5°C Immersion time: 10s ±1s
4	4.20 Solvent resistance of the marking	The marking shall be legible	Solvent: Industrial isopropanol. Solvent temperature: 23°C ±5°C Dipping time: 5min ±0.5min Condition: scrub Scrub material: absorbent cotton Reverting time: No
5	4.2 Initial measurement	Capacitance, Tgδ	
	4.6 Rapid change of temperature	There shall be no evidence of deterioration.	T _A = -40°C, T _B = +110°C 5 cycles Duration: t = 30min
	4.7 Vibration	There shall be no evidence of deterioration.	Amplitude 0.75mm or acceleration 100m/s ² (whichever is the smaller severity), f: 10Hz to 500Hz. Three directions, 2h for each direction, total 6h.
	4.8 Bump	There shall be no evidence of deterioration.	4 000 times, Acceleration: 400m/s ² , Pulse duration, 6ms
	Final measurement	There shall be no visible damage $\Delta C/C \leq \pm 5\%$ (relative to the initial value)	
6	4.11 Climate sequence	Initial measurement	
		Dry heat	+110°C, 16h
		Damp heat, Cyclic	Test Db, Severity: b, the first cycle
		Cold	-40°C, 2h
		Damp heat, cyclic other	Test Db, Severity b, the other cycles
		Final measurement	There shall be no visible damage, legible marking $\Delta C/C \leq \pm 5\%$ (relative to the initial value) Increase of tgδ: C _N ≤ 1μF: ≤ 0.008 (10kHz) C _N > 1μF: ≤ 0.005 (1kHz) Dielectric strength : there shall be no permanent breakdown or flashover I.R.: ≥ 50% of the rated value

No.	Item	Performance	Test Method (IEC 60384-14)
7	4.12 Damp heat steady state	There shall be no visible damage, legible marking $\Delta C/C \leq \pm 5\%$ (relative to the initial value) Increase of $\text{tg}\delta$: $C_N \leq 1\mu\text{F}$: ≤ 0.008 (10kHz) $C_N > 1\mu\text{F}$: ≤ 0.005 (1kHz) Dielectric strength : there shall be no permanent breakdown or flashover I.R.: $\geq 50\%$ of the rated value	Temperature: $40^\circ\text{C} \pm 2^\circ\text{C}$ Humidity: $93 \pm 3\% \text{RH}$ Duration: 56 days
8	4.13 Impulse voltage	There are three or more waveforms which indicate that no self-heating breakdown have occurred when it is monitored by the monitor	Each individual capacitor shall be subjected to 24 impulses of the same polarity (when any three successive impulses are shown by the monitor to have a wave form indicating that no self-heating breakdown have taken place the impulses can be stopped), the time between impulses shall not be less than 10S, and the peak value of the voltage impulse: 2.5kV (suitable for $C_N \leq 1\mu\text{F}$; When $C_N > 1\mu\text{F}$, the capacitor can endure pulse voltage value is $2.5/\sqrt{C_N}$ kV)
9	4.14 Endurance	There shall be no visible damage, legible marking $\Delta C/C \leq \pm 10\%$ (relative to the initial value) Increase of $\text{tg}\delta$: $C_N \leq 1\mu\text{F}$: ≤ 0.008 (10kHz) $C_N > 1\mu\text{F}$: ≤ 0.005 (1kHz) Dielectric strength : There shall be no breakdown or flashover I.R. : $\geq 50\%$ of the rated value	$+110^\circ\text{C}$, $1.25U_R$ V a.c., 1 000h The voltage shall be subjected to $1000V_{\text{rms}}$ for 0.1s every one hour during test.
10	4.15 Charging and discharging	$\Delta C/C \leq \pm 10\%$ (relative to the initial value) Increase of $\text{tg}\delta$: $C_N \leq 1\mu\text{F}$: ≤ 0.008 (10kHz) $C_N > 1\mu\text{F}$: ≤ 0.005 (1kHz) I.R. : $\geq 50\%$ of the rated value	Times: 10 000 Duration of charging: 0.5s Duration of discharging: 0.5s Charging voltage: $\sqrt{2} U_R$ V d.c. Charging resistance: $220/C_N$ (Ω) or the current $\leq 1.0\text{A}$ (whichever is the minor) Discharging resistance: $R = \frac{\sqrt{2}U_R}{C_N \times \frac{dU}{dt}} (\Omega)$ C_N : Capacitance (μF) dU/dt (V/us) : $100\text{V}/\mu\text{s}$
11	4.17 Passive flammability	The flaming time of each capacitor shall not go beyond 10s after it is taken apart from the flame. Drop of each capacitor caused by flame shall not fire the tissue below.	Ref.item 4.17 Needle flame test The category of flammability: B Expose time: 1 time Capacitor Volume Exposing time $250 < V(\text{mm}^3) \leq 500$ 20s $500 < V(\text{mm}^3) \leq 1750$ 30s $V(\text{mm}^3) > 1750$ 60s

No.	Item	Performance	Test Method (IEC 60384-14)
12	4.18 Active flammability	The cheese cloth around the capacitor shall not burn with a flame.	<p>The specimens shall be individually wrapped in at least 1, but not more than 2, complete layers of cheesecloth, the cheesecloth shall be untreated pure cotton cloth.</p> <p>Each sample shall be subjected to 20 discharges, the interval between successive discharges shall be 5s.</p> <p>$U_i = 2.5kV_0^{+7\%}$</p> <p>U_R be applied and be maintained for 120_0^{+10} s after the last discharge.</p>

■ Marking

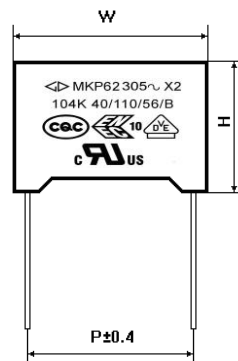

Marking Introduction

Sign	explain	Sign	explain
	Brand	40/110/56/B	Climate category / Passive Flammability Class
MKP62	Type		ENEC-VDE Approval
305~	Rated voltage		CQC Approval
X2	Class		UL, CUL Approval
104K	Rated capacitance and tolerance		

■ Taping specification for box-type capacitors
▲ Outline Drawing

Fig.1 P=5.0, 7.5mm

Fig.2 P=10.0, 15.0mm

▲ Taping Dimensions(mm)

Technology index title	Code	Dimensions				Tolerance
		P=5.0	P=7.5	P=10.0	P=15.0	
Taping type	—	Fig 1	Fig 1	Fig2	Fig 2	—
Part number Digit12-15	Ammo-pack	A201	A301	A405	A605	
Taping pitch	P ₃	12.7	12.7	25.4	25.4	±1.0
Feed hole pitch	P ₀	12.7	12.7	12.7	12.7	±0.3
Center of wire	P ₁	3.85	2.6	7.7	5.2	±0.7
Center of body	P ₂	6.35	6.35	12.7	12.7	±1.3
Pitch of taping wire	F**	5.0	7.5	10.0	15.0	+0.6 -0.1
Component alignment	△S	0	0	0	0	±2.0
Height of component from tape center	H***	18.5	18.5	18.5	18.5	±0.5
Carrier tape width	W	18.0	18.0	18.0	18.0	+1.0 -0.5
Hold down tape width	W ₀	6min	10min	10min	10min	—
Hole position	W ₁	9.0	9.0	9.0	9.0	±0.5
Hold down tape position	W ₂	3max	3max	3max	3max	—
Feed hole dia.	D ₀	4.0	4.0	4.0	4.0	±0.2
Tape thickness	t	0.7	0.7	0.7	0.7	±0.2

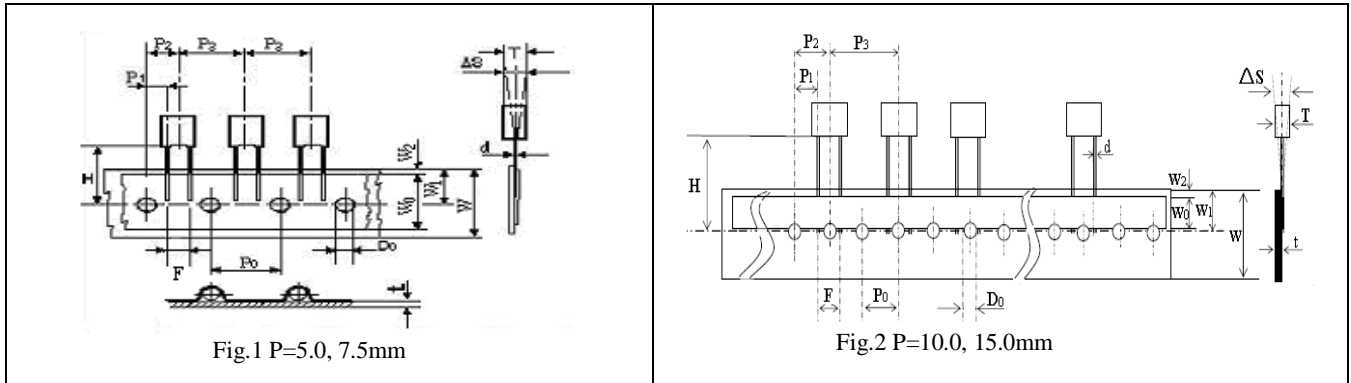
▲ Packing Quantity

Pitch (mm)	Box thickness T(mm)	Ammo-pack (pcs/box)	
		Domestic	Export
5.0	2.5	2500	2 000
	3.5	1 700	1 500
	4.5	1 400	1 300
	5.0	1 200	1 000
	6.0	1 000	800
7.5	3.5	1 700	1 500
	4.0	1 500	1 350
	5.0	1 200	1 050
	6.0	1 000	850
10.0/ 15.0	4.0	750	650
	5.0	600	500
	6.0	500	450
15.0	7.5	400	350
	8.5	350	300
	10.0	300	250
	11.0	250	220

Note: * P₀=15mm is also available;

**F can be other lead spacing;

***H=16.5mm is available;

■ Packing box sizes(mm)

1. Out packing box for bulk

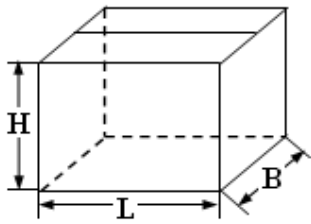

L:375±5
B:375±5
H:265±5

2. Inner packing box for bulk

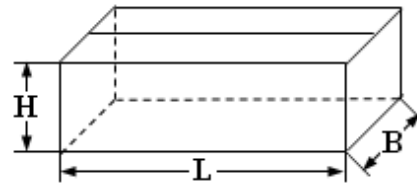

L:355±3
B:175±3
H:118±3

3. Box sizes for Ammo-pack

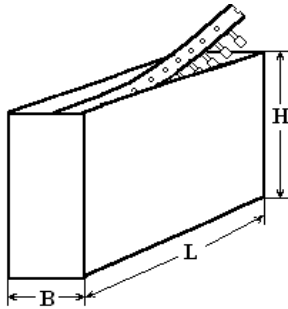

L:330±3
B:48±3
H:260±3

X-ON Electronics

Largest Supplier of Electrical and Electronic Components

Click to view similar products for [faratronic](#) manufacturer:

Other Similar products are found below :

[C42Q2225K9SC000](#) [C312J105JB2C000](#) [C42P2474K9SCB5A](#) [C163L474J0A2000](#) [C43Q1224K9SC000](#) [C823D822J60Q350](#)
[C212A475K9AC000](#) [C323A683K60C000](#) [C43Q1472M40C000](#) [C242A105J2SC000](#) [C222S105J60C000](#) [C4BQ2475MBWC500](#)
[C42Q2225MBSC000](#) [C43Q1103K40C000](#) [C352J333J40C000](#) [C241J105J2SA201](#) [D43Q1224KB0C000](#) [C222S105J60Y350](#)
[C823A104J90C000](#) [C823A563J90C000](#) [C323A104J90C000](#) [C42Q2474K6FC450](#) [C4BQ2225MBWC000](#) [C42Q2334K6SC000](#)
[C43Q1103K6SC000](#) [C823D471J60C350](#) [C42Q2475MBFC500](#) [C312E474J6SC000](#) [C322J104J60Q350](#) [C42Q2105M9SC000](#)
[C3D1U506KFAA382](#) [C322E225K90C000](#) [C6AQ1475JB20000](#) [C42Q2224M6SC000](#) [C242A474J2SA201](#) [C42Q2473M4SC000](#)
[C823A223J60C000](#) [C352J473J40C000](#) [C42P2475KB0C000](#) [C42Q2474K6FC000](#) [C42Q2224K6SC000](#) [C222S154J40A40E](#)
[C222T105K90C000](#) [C312A105J6SC000](#) [C252A475J60C322](#) [C42Q2335KBAC350](#) [C42P2225K9SC000](#) [C322E224K40C000](#)
[C823C103J60C350](#) [C242A224J2SA201](#)