

金属化聚丙烯膜抗干扰电容器 (Y2类, 300Vac) Metallized polypropylene film Interference Suppression capacitor (Class Y2,300Vac)

■ 外形图 Outline Drawing

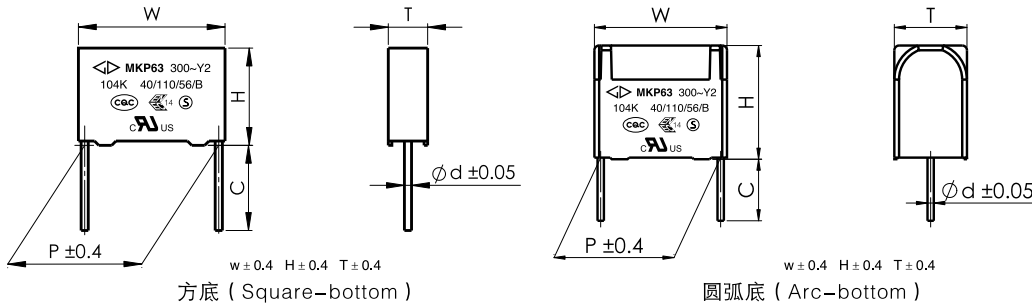

■ 特点

- 金属化聚丙烯
- 能承受过压冲击
- 优异的阻燃性能
- 广泛用于电源接地、旁路、天线耦合等抗干扰场合

■ Features

- Metallized polypropylene structure
- Withstanding overvoltage stressing
- Excellent active and passive flame resistant abilities
- Widely used in line to ground, line-by-pass, antenna coupling interference suppression circuit, etc

■ 安全认证 Safety Approvals

●		CQC (中国)	IEC 60384-14:2005, Y2, 300Vac, 0.001 μF ~ 1.0 μF, 40/110/56/B 证书号(Certificate No.): CQC04001009958
●		ENEC-SEMKO (欧盟)	EN 60384-14:2013, Y2, 300Vac, 0.001 μF ~ 1.0 μF, 40/110/56/B 证书号(Certificate No.): SE/0366-2C
●		UL/CUL (美国/加拿大)	UL 60384-14:2014, CSA E60384-14:09, Y2, 300Vac, 0.001 μF ~ 1.0 μF, 40/110/56/B 证书号(File No.): E186600, CCN: FOWX2/B
●		KC (韩国)	K 60384-14(2006-12), Y2, 300Vac, 0.001 μF ~ 0.1 μF, 40/110/56/B 证书号(Certificate No.): SU03060-12005

■ 技术要求 Specifications

电容器类别 Class	Y2 类		
气候类别 / 阻燃等级 Climatic Category/Passive Flammability Category	40/110/56/B		
工作温度范围 Operating Temperature Range	-40°C ~ +110°C		
额定电压 Rated Voltage (U _R)	300Vac, 50/60Hz		
最大连续直流电压 Maximum continuous DC voltage	1 500Vdc		
电容量范围 Capacitance Range	0.0010μF ~ 1.0μF		
电容量偏差 Capacitance Tolerance	± 10%(K), ± 20%(M)		
耐电压 Voltage Proof	引线之间 Between Terminals:	2 000Vac(2s) or	4 000Vdc(2s) C _N ≤ 0.33μF 3 700Vdc(2s) C _N > 0.33μF
	极壳之间 Between Terminals To Case:	2 500Vac(1min)	
绝缘电阻 Insulation Resistance	R ≥ 15 000MΩ, C _N ≤ 0.33μF RC _N ≥ 5 000s, C _N > 0.33μF (20°C, 100V, 1min)		
损耗角正切 Dissipation Factor (tan δ)	≤ 30 × 10 ⁻⁴ (1kHz, 20°C)	≤ 40 × 10 ⁻⁴ (10kHz, 20°C)	



MKP63

Code: C43

产品编码说明 Part number system

■ 18位产品代码如下：

The 18 digits part number is formed as follow:

1	2	3	4	5	6	7	8	9	10	11	12	13	14	15	16	17	18
C	4	3															

第1~3位	型号代码 C43=MKP63	Digit 1 to 3	Series code C43=MKP63
第4~5位	交流额定电压 Q1=300V	Digit 4 to 5	AC rated voltage Q1=300V
第6~8位	标称容量 举例：103=10 × 10 ³ pF=0.01μF	Digit 6 to 8	Rated capacitance value For example: 103=10 × 10 ³ pf=0.01μF
第9位	容量偏差 K= ± 10%, M= ± 20%	Digit 9	Capacitance tolerance K= ± 10%, M= ± 20%
第10位	引线脚距P 3=7.5mm 4=10.0mm 6=15.0mm 9=22.5mm B=27.5mm F=37.5mm	Digit 10	Pitch 3=7.5mm 4=10.0mm 6=15.0mm 9=22.5mm B=27.5mm F=37.5mm
第11位	内部特征码	Digit 11	Internal use
第12~15位	引线加工和包装代码	Digit 12 to 15	Lead form and packaging code
第16~18位	内部特征码	Digit 16 to 18	Internal use

■ Table 1 引线加工和包装代码 lead form and packaging code

第 12 位 Digit 12		第 13 位 Digit 13		第 14 位 Digit 14		第 15 位 Digit 15	
代码 Code	说明 explanation	代码 Code	说明 explanation	代码 Code	说明 explanation	代码 Code	说明 explanation
A	弹带包装 ammo-pack	3 4 6	F=7.5mm F=10.0mm F=15.0mm	0	表示直脚 straight	1 5	产品在连续的两个载带孔之间 each cap. among two consecutive holes P3=12.7mm,H=18.5mm (For pitch=7.5mm) P3=25.4mm;H=18.5mm (For pitch=10.0/15.0mm) (Detail parameter refer to catalogue pag 17)
C	直脚 straight lead “C” in the figure above	代码 Code	说明 explanation			0	引线长度偏差 ±0.5mm 或标准长度 Length tolerance ± 0.5mm Or standard length
		00 45	标准的引线长度 (18mm~26mm) standard lead length 引线长度 4.5mm lead length 4.5mm				
D	软绝缘线 (多股) Insulated stranded leads	C5 K0 K2 L0	35mm 100mm 120mm 200mm			1 2 3 4	引线长度偏差 -5mm ~ 0mm Length tolerance -5 mm ~ 0 mm 引线长度偏差 0 mm ~ +5 mm Length tolerance 0 mm ~ +5 mm 引线长度偏差 0 mm ~ +10mm Length tolerance 0 mm ~ +10mm 引线长度偏差 ± 5 mm Length tolerance ± 5 mm
E	硬绝缘线 (单股) Insulated solid leads						
M	软绝缘线 (多股), 外壳带正底安装耳 Insulated stranded leads Box with mounting foot		注 1: 这里的长度包含剥线长度 Note 1: This length includes the stripping parts. 注 2: 一般 P ≥ 27.5 产品才可选用绝缘线方式 Note 2: Normally, for P ≥ 27.5 Caps can choice Insulated leads.				

■ 外形尺寸 Dimensions (mm)

300Vac						
C _N (μF)	W	H	T	P	d	Part number
0.0010	10.5	9.0	4.0	7.5	0.6	C43Q1102-30****++
0.0012	10.5	9.0	4.0	7.5	0.6	C43Q1122-30****++
0.0015	10.5	9.0	4.0	7.5	0.6	C43Q1152-30****++
0.0018	10.5	9.0	4.0	7.5	0.6	C43Q1182-30****++
0.0022	10.5	9.0	4.0	7.5	0.6	C43Q1222-30****++
0.0027	10.5	9.0	4.0	7.5	0.6	C43Q1272-30****++
0.0033	10.5	11.0	5.0	7.5	0.6	C43Q1332-30****++
0.0039	10.5	11.0	5.0	7.5	0.6	C43Q1392-30****++
0.0047	10.5	12.0	6.0	7.5	0.6	C43Q1472-30****++
0.0056	10.5	12.0	6.0	7.5	0.6	C43Q1562-30****++
0.010	13.0	9.0	4.0	10.0	0.6	C43Q1102-40****++
0.0012	13.0	9.0	4.0	10.0	0.6	C43Q1122-40****++
0.0015	13.0	9.0	4.0	10.0	0.6	C43Q1152-40****++
0.0018	13.0	9.0	4.0	10.0	0.6	C43Q1182-40****++
0.0022	13.0	9.0	4.0	10.0	0.6	C43Q1222-40****++
0.0027	13.0	9.0	4.0	10.0	0.6	C43Q1272-40****++
0.0033	13.0	9.0	4.0	10.0	0.6	C43Q1332-40****++
0.0039	13.0	9.0	4.0	10.0	0.6	C43Q1392-40****++
0.0047	13.0	11.0	5.0	10.0	0.6	C43Q1472-40****++
0.0056	13.0	11.0	5.0	10.0	0.6	C43Q1562-41****++
0.0068	13.0	11.0	5.0	10.0	0.6	C43Q1682-41****++
0.0068	13.0	7.5	9.5	10.0	0.6	C43Q1682-4C****++
0.0082	13.0	12.0	6.0	10.0	0.6	C43Q1822-40****++
0.010	13.0	12.0	6.0	10.0	0.6	C43Q1103-40****++
0.015	13.0	12.0	6.0	10.0	0.6	C43Q1153-4S****++
0.0022	17.5	9.5	5.0	15.0	0.6	C43Q1222-60****++
0.0027	17.5	9.5	5.0	15.0	0.6	C43Q1272-61****++
0.0033	17.5	9.5	5.0	15.0	0.6	C43Q1332-61****++
0.0039	17.5	9.5	5.0	15.0	0.6	C43Q1392-61****++
0.0047	17.5	9.5	5.0	15.0	0.6	C43Q1472-61****++
0.0056	17.5	9.5	5.0	15.0	0.6	C43Q1562-61****++
0.0068	17.5	9.5	5.0	15.0	0.6	C43Q1682-61****++
0.0082	17.5	9.5	5.0	15.0	0.6	C43Q1822-61****++
0.010	17.5	9.5	5.0	15.0	0.6	C43Q1103-6S****++
0.012	17.5	11.0	5.0	15.0	0.6	C43Q1123-6S****++
0.015	17.5	11.0	5.0	15.0	0.6	C43Q1153-6S****++
0.018M	17.5	11.0	5.0	15.0	0.6	C43Q1183M6S****++
0.018K	17.5	12.0	6.0	15.0	0.6	C43Q1183K6S****++
0.022	17.5	12.0	6.0	15.0	0.6	C43Q1223-6S****++
0.027M	17.5	12.0	6.0	15.0	0.6	C43Q1273M6S****++
0.027K	17.5	12.0	7.0	15.0	0.6	C43Q1273K6S****++
0.033	17.5	13.5	7.5	15.0	0.6	C43Q1333-6S****++
0.033	17.5	12.5	9.0	15.0	0.6	C43Q1333-6A****++
0.039	17.5	13.5	7.5	15.0	0.6	C43Q1393-6S****++
0.039	17.5	12.5	9.0	15.0	0.6	C43Q1393-6A****++
0.047	17.5	14.5	8.5	15.0	0.6	C43Q1473-6S****++
0.047	17.5	12.0	13.0	15.0	0.8	C43Q1473-6C****++
0.056	17.5	16.0	10.0	15.0	0.8	C43Q1563-6S****++
0.068	17.5	16.0	10.0	15.0	0.8	C43Q1683-6S****++
0.082	17.5	19.0	11.0	15.0	0.8	C43Q1823-6S****++
0.033	26.5	15.0	6.0	22.5	0.8	C43Q1333-90****++
0.039	26.5	15.0	6.0	22.5	0.8	C43Q1393-90****++
0.047	26.5	15.0	6.0	22.5	0.8	C43Q1473-9S****++
0.056	26.5	15.0	6.0	22.5	0.8	C43Q1563-9S****++
0.068M	26.5	15.0	6.0	22.5	0.8	C43Q1683M9S****++
0.068K	26.5	16.0	7.0	22.5	0.8	C43Q1683K9S****++
0.082	26.5	16.0	7.0	22.5	0.8	C43Q1823-9S****++

300Vac						
C _N (μF)	W	H	T	P	d	Part number
0.10	26.5	17.0	8.5	22.5	0.8	C43Q1104-9S****++
0.12	26.5	17.0	8.5	22.5	0.8	C43Q1124-9S****++
0.15	26.5	18.5	10.0	22.5	0.8	C43Q1154-9S****++
0.18	26.5	20.0	11.0	22.5	0.8	C43Q1184-9S****++
0.22	26.5	22.0	12.0	22.5	0.8	C43Q1224-9S****++
0.27	26.5	23.0	13.5	22.5	0.8	C43Q1274-9S****++
0.33	26.5	24.5	15.5	22.5	0.8	C43Q1334-9S****++
0.33	26.5	29.5	14.5	22.5	0.8	C43Q1334-9A****++
0.39M	26.5	29.5	14.5	22.5	0.8	C43Q1394M9S****++
0.10	32.0	18.0	9.0	27.5	0.8	C43Q1104-B0****++
0.12	32.0	18.0	9.0	27.5	0.8	C43Q1124-B0****++
0.15	32.0	18.0	9.0	27.5	0.8	C43Q1154-BS****++
0.15	32.0	12.0	18.0	27.5	0.8	C43Q1154-BC****++
0.18	32.0	20.0	11.0	27.5	0.8	C43Q1184-BS****++
0.22	32.0	20.0	11.0	27.5	0.8	C43Q1224-BS****++
0.22M	32.0	12.0	18.0	27.5	0.8	C43Q1224MBC****++
★ 0.22K	32.0	12.0	22.0	27.5	0.8	C43Q1224KBC****++
0.27M	32.0	20.0	11.0	27.5	0.8	C43Q1274MBS****++
0.27K	32.0	22.0	13.0	27.5	0.8	C43Q1274KBS****++
0.33M	32.0	22.0	13.0	27.5	0.8	C43Q1334MBS****++
0.33K	32.0	25.0	13.0	27.5	0.8	C43Q1334KBS****++
0.33K	32.0	24.5	15.0	27.5	0.8	C43Q1334KBA****++
★ 0.33M	32.0	12.0	22.0	27.5	0.8	C43Q1334MBC****++
0.39	32.0	24.5	15.0	27.5	0.8	C43Q1394-BA****++
0.39	32.0	28.0	14.0	27.5	0.8	C43Q1394-BS****++
0.47M	32.0	24.5	15.0	27.5	0.8	C43Q1474MBA****++
0.47M	32.0	28.0	14.0	27.5	0.8	C43Q1474MBS****++
0.47K	32.0	30.0	16.0	27.5	0.8	C43Q1474KBS****++
0.47K	32.0	28.0	17.0	27.5	0.8	C43Q1474KBA****++
★ 0.47	32.0	16.0	27.5	27.5	0.8	C43Q1474-BC****++
0.56	32.0	30.0	16.0	27.5	0.8	C43Q1564-BS****++
0.56	32.0	28.0	17.0	27.5	0.8	C43Q1564-BA****++
0.68M	32.0	29.0	19.0	27.5	0.8	C43Q1684MBA****++
0.68K	32.0	30.0	21.0	27.5	0.8	C43Q1684KBA****++
0.68	32.0	33.0	18.0	27.5	0.8	C43Q1684-BS****++
★ 0.68	32.0	18.5	31.0	27.5	0.8	C43Q1684-BC****++
★ 0.82M	32.0	18.5	31.0	27.5	0.8	C43Q1824MBC****++
0.82M	32.0	33.0	18.0	27.5	0.8	C43Q1824MBS****++
0.82K	32.0	37.0	22.0	27.5	0.8	C43Q1824KBS****++
1.0	32.0	37.0	22.0	27.5	0.8	C43Q1105-BS****++
0.33	41.0	22.0	11.0	37.5	1.0	C43Q1334-FS****++
0.39M	41.0	22.0	11.0	37.5	1.0	C43Q1394MFS****++
0.39K	41.0	24.0	13.0	37.5	1.0	C43Q1394KFS****++
0.47	41.0	24.0	13.0	37.5	1.0	C43Q1474-FS****++
0.47	42.0	15.0	24.0	37.5	1.0	C43Q1474-FC****++
0.56	41.0	26.0	15.0	37.5	1.0	C43Q1564-FS****++
0.56	42.0	28.0	14.0	37.5	1.0	C43Q1564-FA****++
0.68M	41.0	26.0	15.0	37.5	1.0	C43Q1684MFA****++
0.68M	42.0	28.0	14.0	37.5	1.0	C43Q1684MFS****++
0.68K	41.0	30.0	16.0	37.5	1.0	C43Q1684KFS****++
0.68M	42.0	15.0	24.0	37.5	1.0	C43Q1684MFC****++
0.82	41.0	30.0	16.0	37.5	1.0	C43Q1824-FS****++
0.82	42.0	19.0	24.0	37.5	1.0	C43Q1824-FC****++
1.0M	41.0	32.0	17.0	37.5	1.0	C43Q1105MFS****++
1.0K	41.0	33.5	18.5	37.5	1.0	C43Q1105KFS****++

备注: 1. “-”表示容量偏差。 “-”=capacitance tolerance code, M=±20%,K=±10%
 2. “****”表示引线加工和包装代码(见table 1)。“****”=lead form and packing code(refer to table 1)
 3. “★”表示外壳为圆弧底。“★”=Arc bottom of the outer shell.

X-ON Electronics

Largest Supplier of Electrical and Electronic Components

Click to view similar products for [Safety Capacitors](#) category:

Click to view products by [FARATRONIC](#) manufacturer:

Other Similar products are found below :

[B32022B3223K026](#) [B32912A3104K026](#) [46KI3470DQM1K](#) [B32913A3154K](#) [B81123C1102M003](#) [MKPY2-.02230020P15](#)
[46KN333000M1M](#) [46KN422000P0M](#) [DE1E3KX222MJ4BN01F](#) [46KR422000M1K](#) [HUB2200-S](#) [46KF268000M1M](#) [46KI3150NDM2M](#)
[PHE840MD6220MD13R30](#) [PHE840MY6470MD14R06](#) [PHE845VD5470MR06](#) [R463N4100ZAM1K](#) [MKPX2R-1/400/10P27](#)
[YP500101K040B20C2P](#) [YU0AH222M090DAMD0B](#) [LS1808N102K302NX080TM](#) [CY1471KE1IEB46X2A2](#) [CY1222ME5IEE48O2A2](#)
[MPX474K31DTEV158G0](#) [CY1471ME19EE45W2A2](#) [MPX104K31D2KN158HF](#) [MPX224K31D2KN158G0](#) [PX104K2W1502](#)
[YU1AH222M090DASD0H](#) [C47S1472K60C000](#) [MP2224K32C5J6LC](#) [H102M050FQ55250L750A](#) [MP2474K32D6R8LC](#)
[MP2224K32C3J6LC](#) [MP2104K32C3J6LC](#) [PX334K2C1006](#) [YU0AC222M080L20C7B](#) [MP2473K27B2X6LC](#) [MP2224K32D4J8LC](#)
[MP2684K32D6T8LC](#) [ST3Y1Y5U332M500VAC](#) [ST3Y1Y5V472M500VAC](#) [MP2474K32D4X8LC](#) [MP2474K32D4J8LC](#)
[YU0AH332M110L4EB0B](#) [CY1681ME1IEE45S2A2](#) [Y1220J-E1I-B4-AC400V](#) [Y1120K-E1I-B4-AC400V](#) [MP2154K32D2R8LC](#)
[ST1Y1Y5V222M500VAC](#)