



SPECIFICATION FOR APPROVAL

File No.: O/FRK 0.GS.E.C43-C15

Product Name	Metallized Polypropylene Film Interference Suppression Capacitor (Class Y2,300Vac)
Product Type	MKP63
Product Code	C43
Customer	
Customer Code	
Issue Date	

Xiamen Faratronic Co. Ltd.			Approved by Customer
Drafted	Checked	Approved	



厦门法拉电子股份有限公司

Xiamen Faratronic Co. Ltd.

地址： 中国厦门市海沧区新园路 99 号

Add: No.99 Xinyuan Road, Haicang District, Xiamen, China

Export business

HK office : **Faratronic (HK) Co. Ltd.**

TEL: 0086-592-6208609 6208608

0852-2898 9168

FAX: 0086-592-6208557

0852-2898 9683

Mail: Vivian@faratronic.com.cn

hkoffice@faratronic.com.hk

Donny@faratronic.com.cn

kolin@faratronic.com.hk

james@faratronic.com.cn

Http: www.faratronic.com.cn

www.faratronic.com

*.The specification are the property of Xiamen Faratronic Co.Ltd and shall not be copied or used as commercial purposes without permission.

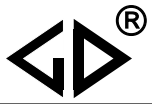

Version history

Current version	Date	Author	Change description

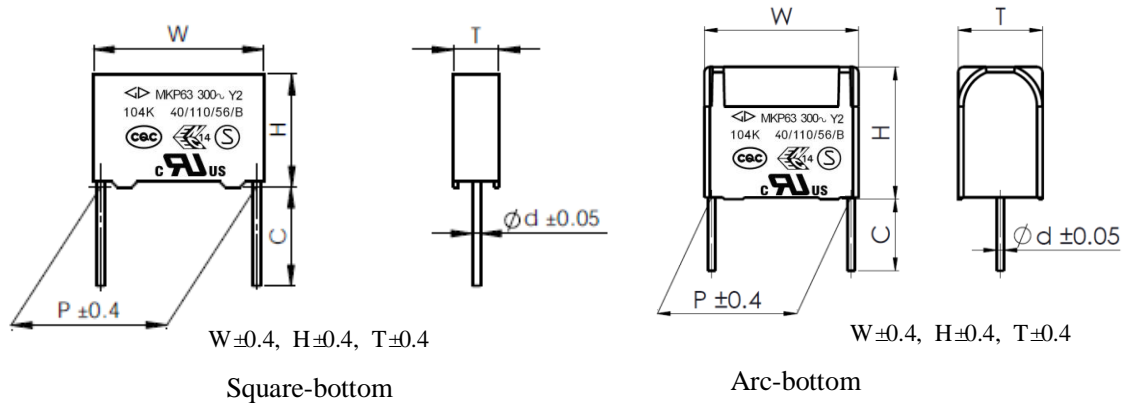
Metallized polypropylene film interference suppression capacitor (Class Y2, 300Vac)
Outline Drawing

Features

- Withstanding overvoltage stressing
- Excellent active and passive flame resistant abilities
- Widely used in across-the-line, line-by-pass, antenna Coupling interference suppression circuit, etc.

Safety Approvals

●		CQC	IEC 60384-14:2005, Y2, 300Vac, 0.001 μ F~1.0 μ F, 40/110/56/B Certificate No.: CQC04001009958
●		ENEC-SEMKO	EN 60384-14:2013, Y2, 300Vac, 0.001 μ F~1.0 μ F, 40/110/56/B Certificate No.: SE/0366-2C
●		UL/CUL	UL60384-14:2014, CSA E60384-14:09, Y2, 300Vac, 0.001 μ F~1.0 μ F, 40/110/56/B File No.: E186600, CN: FOWX2/8
●		KC	K60384-14(2006-12), Y2, 300Vac, 0.001 μ F~0.10 μ F, 40/110/56/B Certificate No.: SU03060-12005

Specifications

Class	Class Y2	
Climatic Category / Passive Flammability Category	40/110/56/B	
Operating Temperature Range	-40°C ~ +110°C	
Rated Voltage (U_R)	300Vac, 50/60Hz	
Maximum continuous DC voltage	1 500Vdc	
Capacitance Range	0.0010 μ F~1.0 μ F	
Capacitance Tolerance	$\pm 10\%$ (K), $\pm 20\%$ (M)	
Voltage Proof	Between Terminals:	2 000Vac(2s) or 4 000Vdc(2s) $C_N \leq 0.33\mu F$ 3 700Vdc(2s) $C_N > 0.33\mu F$
	Between Terminals To Case:	2 500Vac(1min)
Insulation Resistance	$R \geq 15\ 000M\Omega$, $C_N \leq 0.33\mu F$ $RC_N \geq 5\ 000s$, $C_N > 0.33\mu F$ (20°C, 100V, 1min)	
Dissipation Factor	$\leq 30 \times 10^{-4}$ (1kHz, 20°C)	$\leq 40 \times 10^{-4}$ (10kHz, 20°C)

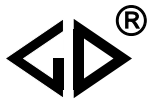

■ Part number system

The 18 digits part number is formed as follow:

1	2	3	4	5	6	7	8	9	10	11	12	13	14	15	16	17	18
C	4	3															

Digit 1 to 3 Series code

C43=MKP63

Digit 4 to 5 A.C. rated voltage

Q1=300V

Digit 6 to 8 Rated capacitance value

For example : 103=10×10³ pF= 0.01μF

Digit 9 Capacitance tolerance

K=±10%, M=±20%

Digit 10 Pitch

3=7.5mm 4=10mm 6=15mm

9=22.5mm B=27.5mm F=37.5mm

Digit 11 Internal use

Digit 12 to 15 Lead form and packaging code

Digit 16 to 18 Internal use

Table 1 Lead form and packaging code

Digit 12		Digit 13		Digit 14		Digit 15	
code	explanation	code	explanation	code	explanation	code	explanation
A	ammo-pack	3 4 6	F=7.5mm F=10.0mm F=15.0mm	0	Straight	1 5	each cap. among two consecutive holes P3=12.7mm,H=18.5mm (For P=7.5mm) P3=25.4mm;H=18.5mm (For pitch=10/15mm) (Detail parameter refer to page 11)
C	straight lead "C" in the figure above	code	explanation			0 2	Length tolerance ±0.5mm or standard length Length tolerance ±0.3mm
		00	standard lead length (18mm~26mm)				
		45	lead length 4.5mm				
		35	lead length 3.5mm				
		32	lead length 3.2mm				
D	Insulated stranded leads	C5 K0 K2 L0	35mm 100mm 120mm 200mm	Note 1: This length includes the stripping parts.	Note 2: Normally, for P ≥ 27.5 Caps can choice Insulated leads.	1	Length tolerance -5 mm~0 mm
E	Insulated solid leads					2	Length tolerance 0 mm~+5 mm
M	Insulated leads and box with mounting foot					3	Length tolerance 0 mm~+10mm
						4	Length tolerance ±5 mm

Maximum permissible voltage change per unit of time

Rated Voltage (Vac)	Max dV/dt(V/us) at 425Vdc					
	P=7.5mm	P=10mm	P=15mm	P=22.5mm	P=27.5mm	P=37.5mm
300	800	800	600	500	400	300

Note:

1. Rated voltage pulse slope $(dV/dt)_R$ at rated voltage.
2. If the working voltage(U) is lower than the rated voltage(U_R),the capacitor can be worked at a higher dV/dt. In this case, the maximum allowed dV/dt is obtain by multiplying the right value with U_R/U .

Impedance Vs. Frequency

TYPICAL GRAPHS

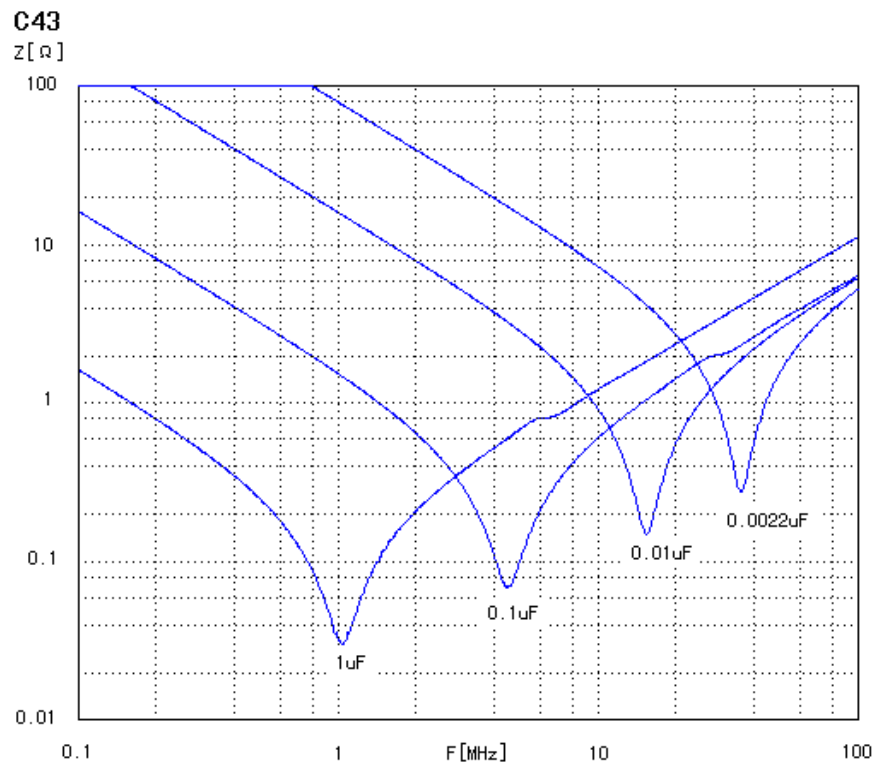
 $Z=f(f)$ Typical values

Quality ensuring test (before shipment):

Inspection item (each batch)	Inspection level (GB/T 2828.1, ISO2859-1)	
	IL	AQL
Appearance inspection	II	1.5%
Dimensions		
Capacitance	II	0.25%
Tangent of the loss angle		
Dielectric strength		
Insulation resistance		
Solderability	S-3	2.5%

■ Test Method And Performance

No.	Item	Performance	Test Method (IEC 60384-14)
1	4.5 Solderability	Good quality of tinning	Solder temperature: 245°C ±5°C Immersion time: 2.0s±0.5s
2	4.3 Terminal strength	There shall be no visible damage	Tense: 0.50<d≤0.80, 10N 0.80<d≤1.25, 20N Bend: 0.50<d≤0.80, 5N 0.80<d≤1.25, 10N The terminals shall be bent 2 times in each direction
3	4.4 Resistance to solder heat	There shall be no visible damage $\Delta C/C \leq \pm 5\%$ (relative to the initial value)	Solder temperature: 260°C ±5°C Immersion time: 10s ±1s
4	4.20 Solvent resistance of the marking	The marking shall be legible	Solvent: Industrial isopropanol. Solvent temperature: 23°C ±5°C Dipping time: 5min ±0.5min Condition: scrub Scrub material: absorbent cotton Reverting time: No
5	4.2 Initial measurement	Capacitance, Tgδ	
	4.6 Rapid change of temperature	There shall be no evidence of deterioration.	T _A = -40°C, T _B = +110°C 5 cycles Duration: t = 30min
	4.7 Vibration	There shall be no evidence of deterioration.	Amplitude 0.75mm or acceleration 100m/s ² (whichever is the smaller severity), f: 10Hz to 500Hz. Three directions, 2h for each direction, total 6h.
	4.8 Bump	There shall be no evidence of deterioration.	4 000 times, Acceleration: 400m/s ² , Pulse duration, 6ms
	Final measurement	There shall be no visible damage $\Delta C/C \leq \pm 5\%$ (relative to the initial value)	
6	4.11 Climate sequence	Initial measurement	
		Dry heat	+110°C, 16h
		Damp heat, Cyclic	Test Db, Severity: b, the first cycle
		Cold	-40°C, 2h
		Damp heat, cyclic other	Test Db, Severity b, the other cycles,
	Final measurement	There shall be no visible damage, legible marking $\Delta C/C \leq \pm 5\%$ (relative to the initial value) Increase of tgδ: ≤0.008 (10kHz) Dielectric strength : there shall be no permanent breakdown or flashover I.R.: ≥ 50% of the rated value	

No.	Item	Performance	Test Method (IEC 60384-14)
7	4.12 Damp heat steady state	There shall be no visible damage, legible marking $\Delta C/C \leq \pm 5\%$ (relative to the initial value) Increase of $\text{tg}\delta: \leq 0.008$ (10kHz) Dielectric strength : there shall be no permanent breakdown or flashover I.R.: $\geq 50\%$ of the rated value	Temperature: $40^\circ\text{C} \pm 2^\circ\text{C}$ Humidity: $93 \pm 3\% \text{RH}$ Duration: 56 days
8	4.13 Impulse voltage	There are three or more waveforms which indicate that no self-heating breakdown have occurred when it is monitored by the monitor	Each individual capacitor shall be subjected to 24 impulses of the same polarity (when any three successive impulses are shown by the monitor to have a wave form indicating that no self-healing breakdown have taken place the impulses can be stopped), the time between impulses shall not be less than 10s, and the peak value of the voltage impulse: 5.0kV
9	4.14 Endurance	There shall be no visible damage, legible marking $\Delta C/C \leq \pm 10\%$ (relative to the initial value) Increase of $\text{tg}\delta: \leq 0.008$ (10kHz) Dielectric strength : There shall be no breakdown or flashover I.R. : $\geq 50\%$ of the rated value	$+110^\circ\text{C}$, $1.7U_R \text{V a.c.}$ 1 000h The voltage shall be subjected to 1 000Vrms for 0.1s every one hour during test.
10	4.15 Charging and discharging	$\Delta C/C \leq \pm 10\%$ (relative to the initial value) Increase of $\text{tg}\delta$: $C_N \leq 1\mu\text{F}: \leq 0.008$ (10kHz) I.R.: $\geq 50\%$ of the rated value	Times: 10 000 Duration of charging: 0.5s Duration of discharging: 0.5s Charging voltage: $\sqrt{2} U_R \text{V d.c.}$ Charging resistance: $220/C_N (\Omega)$ or the current $\leq 1.0\text{A}$ (whichever is the minor) Discharging resistance: $R = \frac{\sqrt{2}U_R}{C_N \times \frac{dU}{dt}} (\Omega)$ C_N : Capacitance (μF) $dU/dt (\text{V}/\mu\text{s})$: 100V/ μs
11	4.17 Passive flammability	The flaming time of each capacitor shall not go beyond 10s after it is taken apart from the flame. Drop of each capacitor caused by flame shall not fire the tissue below.	Needle flame test The category of flammability: B Expose time: 1 time Capacitor Volume Exposing time $250 < V (\text{mm}^3) \leq 500$ 20s $500 < V (\text{mm}^3) \leq 1750$ 30s $V (\text{mm}^3) > 1750$ 60s

No.	Item	Performance	Test Method (IEC 60384-14)
12	4.18 Active flammability	The cheese cloth around the capacitor shall not burn with a flame.	<p>The specimens shall be individually wrapped in at least 1, but not more than 2, complete layers of cheesecloth, the cheesecloth shall be untreated pure cotton.</p> <p>Each sample shall be subjected to 20 discharges, the interval between successive discharges shall be 5_0^{+1} s.</p> <p>$U_i = 5.0kV_0^{+7}\%$</p> <p>Throughout the test, the $U_R \pm 5\%$ shall be applied across the capacitor under test and shall be maintained for 120_0^{+10} s after the last discharge, unless a blown fuse cause an open circuit.</p>

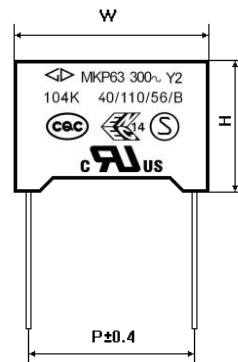
■ Marking

Marking Introduction:

Sign	explain	Sign	explain
	Brand	40/110/56/B	Climate category / Passive Flammability Class
MKP63	Type		CQC Approval
Y2	Class		ENEC-SEMKO Approval
300~	Rated voltage		UL & CUL Approval
104K	Rated capacitance and tolerance		

■ Taping specification for box-type capacitors

▲ Outline Drawing

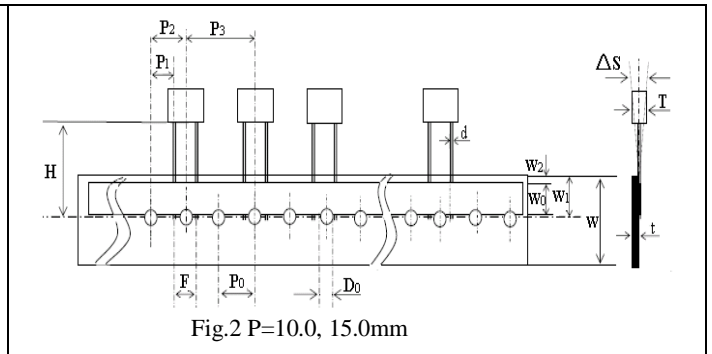
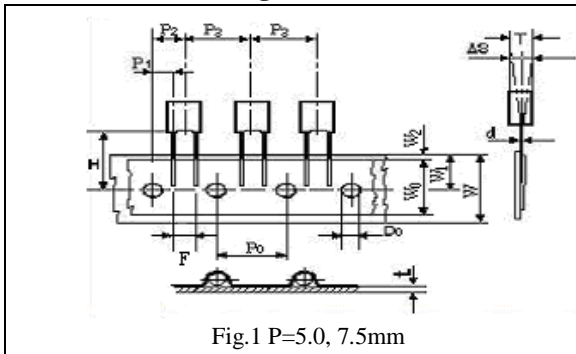

▲ Taping Dimensions(mm)

Technology index title	Code	Dimensions				
		P=5.0	P=7.5	P=10.0	P=15.0	Tolerance
Taping type	—	Fig 1	Fig 1	Fig2	Fig 2	—
Part number Digit12-15	Ammo-pack	A201	A301	A405	A605	
Taping pitch	P ₃	12.7	12.7	25.4	25.4	±1.0
Feed hole pitch	P ₀	12.7	12.7	12.7	12.7	±0.3
Center of wire	P ₁	3.85	2.6	7.7	5.2	±0.7
Center of body	P ₂	6.35	6.35	12.7	12.7	±1.3
Pitch of taping wire	F**	5.0	7.5	10.0	15.0	+0.6 -0.1
Component alignment	ΔS	0	0	0	0	±2.0
Height of component from tape center	H***	18.5	18.5	18.5	18.5	±0.5
Carrier tape width	W	18.0	18.0	18.0	18.0	+1.0 -0.5
Hold down tape width	W ₀	6min	10min	10min	10min	—
Hole position	W ₁	9.0	9.0	9.0	9.0	±0.5
Hold down tape sition	W ₂	3max	3max	3max	3max	—
Feed hole dia.	D ₀	4.0	4.0	4.0	4.0	±0.2
Tape thickness	t	0.7	0.7	0.7	0.7	±0.2

▲ Packing Quantity

Pitch (mm)	Box thickness T(mm)	Ammo-pack (pcs/box)	
		Domestic	Export
5.0	2.5	2500	2 000
	3.5	1 700	1 500
	4.5	1 400	1 300
	5.0	1 200	1 000
	6.0	1 000	800
7.5	3.5	1 700	1 500
	4.0	1 500	1 350
	5.0	1 200	1 050
	6.0	1 000	850
10.0/ 15.0	4.0	750	650
	5.0	600	500
	6.0	500	450
15.0	7.5	400	350
	8.5	350	300
	10.0	300	250
	11.0	250	220

Note: * P₀=15mm is also available;

**F can be other lead spacing;

***H=16.5mm is available;

■ Packing box sizes(mm)

1. Out packing box for bulk

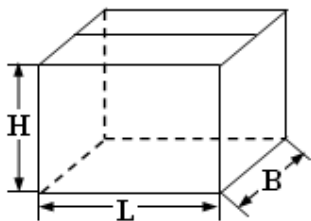

L:375±5
B:375±5
H:265±5

2. Inner packing box for bulk

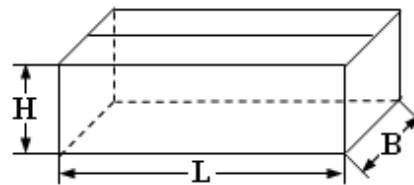

L:355±3
B:175±3
H:118±3

3. Box sizes for Ammo-pack

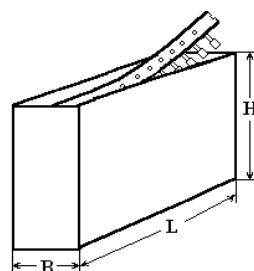

L:330±3
B:48±3
H:260±3

X-ON Electronics

Largest Supplier of Electrical and Electronic Components

Click to view similar products for [Safety Capacitors](#) category:

Click to view products by [FARATRONIC](#) manufacturer:

Other Similar products are found below :

[R49AN347000A1K](#) [B32022B3223K026](#) [B32912A3104K026](#) [46KI3470DQM1K](#) [B32913A3154K](#) [MKPY2-.02230020P15](#) [46KN333000M1M](#)
[DE1E3KX222MJ4BN01F](#) [46KN347000M1M](#) [46KR422000M1K](#) [B32924C3824K189](#) [46KI3100DQM1M](#) [HUB2200-S](#) [HUB820-P](#) [BFC2](#)
[33910103](#) [46KN3330JBM1K](#) [463I333000M1K](#) [46KF2470JBN0M](#) [46KF268000M1M](#) [46KI22205001M](#) [46KI24705201K](#) [46KI2470CK01M](#)
[46KI2470ND01K](#) [46KI2680JH01M](#) [46KI315000M2K](#) [46KI3150CKM2K](#) [46KI3150CKM2M](#) [46KI3150NDM2M](#) [46KI3220JLM1M](#)
[46KN3150JH01K](#) [46KN34705001K](#) [46KN347050N0K](#) [46KN3470JHP0M](#) [46KN410040H1M](#) [46KN415000P1M](#) [46KW510050M1K](#)
[474I24700003K](#) [PHE840MD6220MD13R30](#) [PHE840MY6470MD14R06](#) [PHE845VD5470MR06](#) [R463N4100ZAM1K](#) [46KR410050M1K](#)
[YV500103Z060B20X5P](#) [MKPX2R-1/400/10P27](#) [YP500101K040B20C2P](#) [YU0AH222M090DAMD0B](#) [LS1808N102K302NX080TM](#)
[ERK610Z472MCRU](#) [R463F210000N0K](#) [R463I26800001K](#)