

Double sided metallized polypropylene film capacitor (Box-type)

■ Outline Drawing

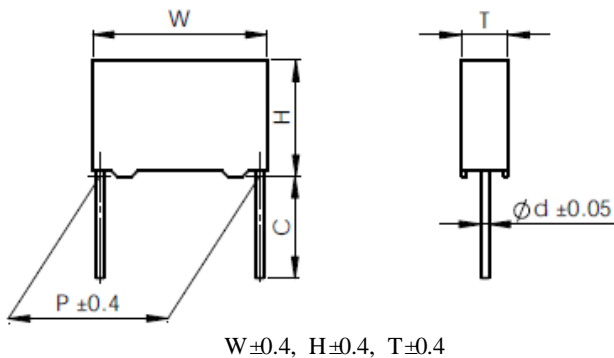

■ Features

- Double sided metallized polypropylene structure
- Low loss and small inherent temperature rise
- Negative temperature coefficient of capacitance
- Excellent active and passive flame resistant abilities

■ Typical Application

- Widely used in high voltage, high frequency and pulse circuit
- Electronic ballasts and compact lamps
- SNUBBER and SCR commutating circuits

■ Specifications

Reference Standard	GB/T 10190 (IEC 60384-16)					
Climatic Category	40/105/56					
Rated Temperature	85°C for U_R (dc); 75°C for U_R (ac)					
Operating Temperature Range	-40°C~105°C (+85°C to +105°C: decreasing factor 1.25% per °C for U_R (dc)) (+75°C to +105°C: decreasing factor 1.35% per °C for U_R (ac))					
Rated Voltage	250V, 400V, 630V, 1 000V, 1 600V, 2 000V					
Capacitance Range	0.00022μF~3.9μF					
Capacitance Tolerance	±2% (G), ±3% (H), ±5% (J), ±10% (K), ±20% (M)					
Voltage Proof	1.60 U_R (5s)					
Dissipation Factor	$\leq 10 \times 10^{-4}$ (1kHz, 20°C)					
Insulation Resistance	$R \geq 100\,000\text{M}\Omega$, $C_N \leq 0.33\mu\text{F}$ $RC_N \geq 30\,000\text{s}$, $C_N > 0.33\mu\text{F}$ (20°C, 100V, 1min)					
Maximum Pulse Rise Time(dV/dt): If the working voltage(U) is lower than the rated voltage(U_R),the capacitor can be worked at a higher dV/dt. In this case, the maximum allowed dV/dt is obtain by multiplying the right value with U_R/U .	U_R (V)	dV/dt(V/us)				
		P=7.5	P=10.0	P=15.0	P=22.5	P=27.5
	250	1 200	1 000	550	250	200
	400	1 800	1 500	900	500	300
	630	3 200	3 200	2 500	1 500	900
	1 000	6 000	6 000	3 300	2 100	1 000
	1 600	--	--	6 000	3 000	2 000
2 000	--	--	10 000	5 000	2 200	



■ Part number system

The 18 digits part number is formed as follow:

1	2	3	4	5	6	7	8	9	10	11	12	13	14	15	16	17	18
C	8	2															

Digit 1 to 3 Series code

C82=MMKP82

Digit 4 to 5 D.C. rated voltage

2E=250V 2G=400V 2J=630V

3A=1000V 3C=1600V 3D=2000V

Digit 6 to 8 Rated capacitance value

For example : 103=10×10³ pF= 0.01μF

Digit 9 Capacitance tolerance

G=±2%, H=±3%

J=±5%, K=±10%, M=±20%

Digit 10 Pitch

3=7.5mm 4=10mm 6=15mm

9=22.5mm B=27.5mm

Digit 11 Internal use

Digit 12 to 15 Lead form and packaging code

Digit 16 to 18 Internal use

Table1 Lead form and packaging code

Digit 12		Digit 13		Digit 14		Digit 15	
code	explanation	code	explanation	code	explanation	code	explanation
A	ammo-pack	3	F=7.5mm	0	straight	1	Each cap. among two consecutive holes P3=12.7mm,H=18.5mm (For pitch=7.5mm)
		4	F=10.0mm				
		6	F=15.0mm				
C	straight lead “C” in the figure above	code	explanation	0		2	Length tolerance ±0.3mm
		00	standard lead length (18mm~26mm)				
		45	lead length 4.5mm				
		35	lead length 3.5mm				
		32	lead length 3.2mm				

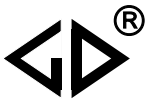

■ Dimensions(mm)

250Vdc(180Vac)						
C _N (μF)	W ±0.4	H ±0.4	T ±0.4	P ±0.4	d ±0.05	Part number
0.0068	10.5	9.0	4.0	7.5	0.6	C822E682-30****+++
0.0082	10.5	9.0	4.0	7.5	0.6	C822E822-30****+++
0.010	10.5	9.0	4.0	7.5	0.6	C822E103-30****+++
0.012	10.5	9.0	4.0	7.5	0.6	C822E123-30****+++
0.015	10.5	9.0	4.0	7.5	0.6	C822E153-30****+++
0.018	10.5	9.0	4.0	7.5	0.6	C822E183-30****+++
0.022	10.5	9.0	4.0	7.5	0.6	C822E223-30****+++
0.027	10.5	11.0	5.0	7.5	0.6	C822E273-30****+++
0.033	10.5	11.0	5.0	7.5	0.6	C822E333-30****+++
0.039	10.5	12.0	6.0	7.5	0.6	C822E393-30****+++
0.047	10.5	12.0	6.0	7.5	0.6	C822E473-30****+++
0.027	13.0	9.0	4.0	10.0	0.6	C822E273-40****+++
0.033	13.0	9.0	4.0	10.0	0.6	C822E333-40****+++
0.039	13.0	9.0	4.0	10.0	0.6	C822E393-40****+++
0.047	13.0	11.0	5.0	10.0	0.6	C822E473-40****+++
0.056	13.0	11.0	5.0	10.0	0.6	C822E563-40****+++
0.068	13.0	12.0	6.0	10.0	0.6	C822E683-40****+++
0.082	13.0	12.0	6.0	10.0	0.6	C822E823-40****+++
0.068	17.5	11.0	5.0	15.0	0.8	C822E683-60****+++
0.082	17.5	11.0	5.0	15.0	0.8	C822E823-60****+++
0.10	17.5	11.0	5.0	15.0	0.8	C822E104-60****+++
0.12	17.5	12.0	6.0	15.0	0.8	C822E124-60****+++
0.15	17.5	12.0	6.0	15.0	0.8	C822E154-60****+++
0.18	17.5	13.5	7.5	15.0	0.8	C822E184-60****+++
0.22	17.5	13.5	7.5	15.0	0.8	C822E224-60****+++
0.27	17.5	14.5	8.5	15.0	0.8	C822E274-60****+++
0.33	17.5	16.0	10.0	15.0	0.8	C822E334-60****+++
0.39	17.5	16.0	10.0	15.0	0.8	C822E394-60****+++

250Vdc(180Vac)						
C _N (μF)	W ±0.4	H ±0.4	T ±0.4	P ±0.4	d ±0.05	Part number
0.22	26.5	15.0	6.0	22.5	0.8	C822E224-90****+++
0.27	26.5	15.0	6.0	22.5	0.8	C822E274-90****+++
0.33	26.5	15.0	6.0	22.5	0.8	C822E334-90****+++
0.39	26.5	16.0	7.0	22.5	0.8	C822E394-90****+++
0.47	26.5	16.0	7.0	22.5	0.8	C822E474-90****+++
0.56	26.5	17.0	8.5	22.5	0.8	C822E564-90****+++
0.68	26.5	18.5	10.0	22.5	0.8	C822E684-90****+++
0.82	26.5	18.5	10.0	22.5	0.8	C822E824-90****+++
1.0	26.5	22.0	12.0	22.5	0.8	C822E105-90****+++
0.82	32.0	18.0	9.0	27.5	0.8	C822E824-B0****+++
1.0	32.0	20.0	11.0	27.5	0.8	C822E105-B0****+++
1.2	32.0	20.0	11.0	27.5	0.8	C822E125-B0****+++
1.5	32.0	22.0	13.0	27.5	0.8	C822E155-B0****+++
1.8	32.0	24.5	15.0	27.5	0.8	C822E185-B0****+++
2.2	32.0	24.5	15.0	27.5	0.8	C822E225-B0****+++
2.7	32.0	33.0	18.0	27.5	0.8	C822E275-B0****+++
3.3	32.0	33.0	18.0	27.5	0.8	C822E335-B0****+++
3.9	32.0	33.0	18.0	27.5	0.8	C822E395-B0****+++

Note: 1. “-”=capacitance tolerance code, M=±20%,K=±10%,J=±5%,H=±3%,G=±2%
 2. “****”=lead form and packaging code (refer to table 1)



■ Dimensions(mm)

400Vdc(250Vac)@						
C _N (μF)	W ±0.4	H ±0.4	T ±0.4	P ±0.4	d ±0.05	Part number
0.0027	10.5	9.0	4.0	7.5	0.6	C822G272-30****+++
0.0033	10.5	9.0	4.0	7.5	0.6	C822G332-30****+++
0.0039	10.5	9.0	4.0	7.5	0.6	C822G392-30****+++
0.0047	10.5	9.0	4.0	7.5	0.6	C822G472-30****+++
0.0056	10.5	9.0	4.0	7.5	0.6	C822G562-30****+++
0.0068	10.5	9.0	4.0	7.5	0.6	C822G682-30****+++
0.0082	10.5	9.0	4.0	7.5	0.6	C822G822-30****+++
0.010	10.5	9.0	4.0	7.5	0.6	C822G103-30****+++
0.012	10.5	9.0	4.0	7.5	0.6	C822G123-30****+++
0.015	10.5	11.0	5.0	7.5	0.6	C822G153-30****+++
0.018	10.5	11.0	5.0	7.5	0.6	C822G183-30****+++
0.022	10.5	12.0	6.0	7.5	0.6	C822G223-30****+++
0.027	10.5	12.0	6.0	7.5	0.6	C822G273-30****+++
0.010	13.0	9.0	4.0	10.0	0.6	C822G103-40****+++
0.012	13.0	9.0	4.0	10.0	0.6	C822G123-40****+++
0.015	13.0	9.0	4.0	10.0	0.6	C822G153-40****+++
0.018	13.0	9.0	4.0	10.0	0.6	C822G183-40****+++
0.022	13.0	9.0	4.0	10.0	0.6	C822G223-40****+++
0.027	13.0	11.0	5.0	10.0	0.6	C822G273-40****+++
0.033	13.0	11.0	5.0	10.0	0.6	C822G333-40****+++
0.039	13.0	12.0	6.0	10.0	0.6	C822G393-40****+++
0.047	13.0	12.0	6.0	10.0	0.6	C822G473-40****+++

400Vdc(250Vac)@						
C _N (μF)	W ±0.4	H ±0.4	T ±0.4	P ±0.4	d ±0.05	Part number
0.033	17.5	11.0	5.0	15.0	0.8	C822G333-60****+++
0.039	17.5	11.0	5.0	15.0	0.8	C822G393-60****+++
0.047	17.5	11.0	5.0	15.0	0.8	C822G473-60****+++
0.056	17.5	11.0	5.0	15.0	0.8	C822G563-60****+++
0.068	17.5	12.0	6.0	15.0	0.8	C822G683-60****+++
0.082	17.5	12.0	6.0	15.0	0.8	C822G823-60****+++
0.10	17.5	13.5	7.5	15.0	0.8	C822G104-60****+++
0.12	17.5	13.5	7.5	15.0	0.8	C822G124-60****+++
0.15	17.5	14.5	8.5	15.0	0.8	C822G154-60****+++
0.18	17.5	16.0	10.0	15.0	0.8	C822G184-60****+++
0.22	17.5	16.0	10.0	15.0	0.8	C822G224-60****+++
0.27	17.5	19.0	11.0	15.0	0.8	C822G274-60****+++
0.12	26.5	15.0	6.0	22.5	0.8	C822G124-90****+++
0.15	26.5	15.0	6.0	22.5	0.8	C822G154-90****+++
0.18	26.5	15.0	6.0	22.5	0.8	C822G184-90****+++
0.22	26.5	16.0	7.0	22.5	0.8	C822G224-90****+++
0.27	26.5	17.0	8.5	22.5	0.8	C822G274-90****+++
0.33	26.5	17.0	8.5	22.50	0.8	C822G334-90****+++
0.39	26.5	18.5	10.0	22.5	0.8	C822G394-90****+++
0.47	26.5	18.5	10.0	22.5	0.8	C822G474-90****+++
0.56	26.5	22.0	12.0	22.5	0.8	C822G564-90****+++
0.68	26.5	22.0	12.0	22.5	0.8	C822G684-90****+++
0.39	32.0	18.0	9.0	27.5	0.8	C822G394-B0****+++
0.47	32.0	18.0	9.0	27.5	0.8	C822G474-B0****+++
0.56	32.0	20.0	11.0	27.5	0.8	C822G564-B0****+++
0.68	32.0	20.0	11.0	27.5	0.8	C822G684-B0****+++
0.82	32.0	22.0	13.0	27.5	0.8	C822G824-B0****+++
1.0	32.0	24.5	15.0	27.5	0.8	C822G105-B0****+++
1.2	32.0	24.5	15.0	27.5	0.8	C822G125-B0****+++
1.5	32.0	33.0	18.0	27.5	0.8	C822G155-B0****+++
1.8	32.0	33.0	18.0	27.5	0.8	C822G185-B0****+++

- Note: 1. “-”=capacitance tolerance code, M=±20%,K=±10%,J=±5%, H=±3%, G=±2%
 2. “****”=lead form and packaging code (refer to table 1)
 3. “@” Not suitable for across-the-line applications. Pls refer to the Interference Suppression Capacitor.



■ Dimensions(mm)

630Vdc(400Vac)						
C _N (μF)	W ±0.4	H ±0.4	T ±0.4	P ±0.4	d ±0.05	Part number
0.00068	10.5	9.0	4.0	7.5	0.6	C822J681-30****+++
0.00082	10.5	9.0	4.0	7.5	0.6	C822J821-30****+++
0.0010	10.5	9.0	4.0	7.5	0.6	C822J102-30****+++
0.0012	10.5	9.0	4.0	7.5	0.6	C822J122-30****+++
0.0015	10.5	9.0	4.0	7.5	0.6	C822J152-30****+++
0.0018	10.5	9.0	4.0	7.5	0.6	C822J182-30****+++
0.0022	10.5	9.0	4.0	7.5	0.6	C822J222-30****+++
0.0027	10.5	9.0	4.0	7.5	0.6	C822J272-30****+++
0.0033	10.5	9.0	4.0	7.5	0.6	C822J332-30****+++
0.0039	10.5	9.0	4.0	7.5	0.6	C822J392-30****+++
0.0047	10.5	9.0	4.0	7.5	0.6	C822J472-30****+++
0.0056	10.5	9.0	4.0	7.5	0.6	C822J562-30****+++
0.0068	10.5	11.0	5.0	7.5	0.6	C822J682-30****+++
0.0082	10.5	11.0	5.0	7.5	0.6	C822J822-30****+++
0.010	10.5	12.0	6.0	7.5	0.6	C822J103-30****+++
0.012	10.5	12.0	6.0	7.5	0.6	C822J123-30****+++
0.0039	13.0	9.0	4.0	10.0	0.6	C822J392-40****+++
0.0047	13.0	9.0	4.0	10.0	0.6	C822J472-40****+++
0.0056	13.0	9.0	4.0	10.0	0.6	C822J562-40****+++
0.0068	13.0	9.0	4.0	10.0	0.6	C822J682-40****+++
0.0082	13.0	9.0	4.0	10.0	0.6	C822J822-40****+++
0.010	13.0	11.0	5.0	10.0	0.6	C822J103-40****+++
0.012	13.0	11.0	5.0	10.0	0.6	C822J123-40****+++
0.015	13.0	12.0	6.0	10.0	0.6	C822J153-40****+++
0.018	13.0	12.0	6.0	10.0	0.6	C822J183-40****+++
0.012	17.5	11.0	5.0	15.0	0.8	C822J123-60****+++
0.015	17.5	11.0	5.0	15.0	0.8	C822J153-60****+++
0.018	17.5	11.0	5.0	15.0	0.8	C822J183-60****+++
0.022	17.5	11.0	5.0	15.0	0.8	C822J223-60****+++
0.027	17.5	11.0	5.0	15.0	0.8	C822J273-60****+++
0.033	17.5	12.0	6.0	15.0	0.8	C822J333-60****+++

630Vdc(400Vac)						
C _N (μF)	W ±0.4	H ±0.4	T ±0.4	P ±0.4	d ±0.05	Part number
0.039	17.5	12.0	6.0	15.0	0.8	C822J393-60****+++
0.047	17.5	12.0	6.0	15.0	0.8	C822J473-60****+++
0.056	17.5	13.5	7.5	15.0	0.8	C822J563-60****+++
0.068	17.5	14.5	8.5	15.0	0.8	C822J683-60****+++
0.082	17.5	14.5	8.5	15.0	0.8	C822J823-60****+++
0.10	17.5	16.0	10.0	15.0	0.8	C822J104-60****+++
0.12	17.5	19.0	11.0	15.0	0.8	C822J124-60****+++
0.047	26.5	15.0	6.0	22.5	0.8	C822J473-90****+++
0.056	26.5	15.0	6.0	22.5	0.8	C822J563-90****+++
0.068	26.5	15.0	6.0	22.5	0.8	C822J683-90****+++
0.082	26.5	15.0	6.0	22.5	0.8	C822J823-90****+++
0.10	26.5	15.0	6.0	22.5	0.8	C822J104-90****+++
0.12	26.5	16.0	7.0	22.5	0.8	C822J124-90****+++
0.15	26.5	17.0	8.5	22.5	0.8	C822J154-90****+++
0.18	26.5	17.0	8.5	22.5	0.8	C822J184-90****+++
0.22	26.5	18.5	10.0	22.5	0.8	C822J224-90****+++
0.27	26.5	22.0	12.0	22.5	0.8	C822J274-90****+++
0.33	26.5	22.0	12.0	22.5	0.8	C822J334-90****+++
0.39	26.5	22.0	12.0	22.5	0.8	C822J394-90****+++
0.15	32.0	18.0	9.0	27.5	0.8	C822J154-B0****+++
0.18	32.0	18.0	9.0	27.5	0.8	C822J184-B0****+++
0.22	32.0	18.0	9.0	27.5	0.8	C822J224-B0****+++
0.27	32.0	18.0	9.0	27.5	0.8	C822J274-B0****+++
0.33	32.0	20.0	11.0	27.5	0.8	C822J334-B0****+++
0.39	32.0	20.0	11.0	27.5	0.8	C822J394-B0****+++
0.47	32.0	22.0	13.0	27.5	0.8	C822J474-B0****+++
0.56	32.0	22.0	13.0	27.5	0.8	C822J564-B0****+++
0.68	32.0	24.5	15.0	27.5	0.8	C822J684-B0****+++
0.82	32.0	28.0	14.0	27.5	0.8	C822J824-B0****+++
1.0	32.0	33.0	18.0	27.5	0.8	C822J105-B0****+++
1.2	32.0	33.0	18.0	27.5	0.8	C822J125-B0****+++

Note: 1. “-”=capacitance tolerance code, M=±20%,K=±10%,J=±5%, H=±3%, G=±2%

2. “****”=lead form and packaging code (refer to table 1)

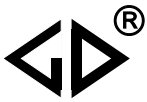

■ Dimensions(mm)

1 000Vdc(600Vac)						
C _N (μF)	W ±0.4	H ±0.4	T ±0.4	P ±0.4	d ±0.05	Part number
0.00047	10.5	9.0	4.0	7.5	0.6	C823A471-30****+++
0.00056	10.5	9.0	4.0	7.5	0.6	C823A561-30****+++
0.00068	10.5	9.0	4.0	7.5	0.6	C823A681-30****+++
0.00082	10.5	9.0	4.0	7.5	0.6	C823A821-30****+++
0.0010	10.5	9.0	4.0	7.5	0.6	C823A102-30****+++
0.0012	10.5	11.0	5.0	7.5	0.6	C823A122-30****+++
0.0015	10.5	11.0	5.0	7.5	0.6	C823A152-30****+++
0.0018	10.5	11.0	5.0	7.5	0.6	C823A182-30****+++
0.0022	10.5	11.0	5.0	7.5	0.6	C823A222-30****+++
0.0027	10.5	12.0	6.0	7.5	0.6	C823A272-30****+++
0.0033	10.5	12.0	6.0	7.5	0.6	C823A332-30****+++
0.0010	13.0	9.0	4.0	10.0	0.6	C823A102-40****+++
0.0012	13.0	9.0	4.0	10.0	0.6	C823A122-40****+++
0.0015	13.0	9.0	4.0	10.0	0.6	C823A152-40****+++
0.0018	13.0	9.0	4.0	10.0	0.6	C823A182-40****+++
0.0022	13.0	9.0	4.0	10.0	0.6	C823A222-40****+++
0.0027	13.0	9.0	4.0	10.0	0.6	C823A272-40****+++
0.0033	13.0	9.0	4.0	10.0	0.6	C823A332-40****+++
0.0039	13.0	11.0	5.0	10.0	0.6	C823A392-40****+++
0.0047	13.0	11.0	5.0	10.0	0.6	C823A472-40****+++
0.0056	13.0	12.0	6.0	10.0	0.6	C823A562-40****+++
0.0068	13.0	12.0	6.0	10.0	0.6	C823A682-40****+++

1 000Vdc(600Vac)						
C _N (μF)	W ±0.4	H ±0.4	T ±0.4	P ±0.4	d ±0.05	Part number
0.0082	17.5	11.0	5.0	15.0	0.8	C823A822-60****+++
0.010	17.5	11.0	5.0	15.0	0.8	C823A103-60****+++
0.012	17.5	11.0	5.0	15.0	0.8	C823A123-60****+++
0.015	17.5	11.0	5.0	15.0	0.8	C823A153-60****+++
0.018	17.5	13.5	7.5	15.0	0.8	C823A183-60****+++
0.022	17.5	13.5	7.5	15.0	0.8	C823A223-60****+++
0.027	17.5	14.5	8.5	15.0	0.8	C823A273-60****+++
0.033	17.5	14.5	8.5	15.0	0.8	C823A333-60****+++
0.039	17.5	16.0	10.0	15.0	0.8	C823A393-60****+++
0.047	17.5	19.0	11.0	15.0	0.8	C823A473-60****+++
0.027	26.5	15.0	6.0	22.5	0.8	C823A273-90****+++
0.033	26.5	15.0	6.0	22.5	0.8	C823A333-90****+++
0.039	26.5	15.0	6.0	22.5	0.8	C823A393-90****+++
0.047	26.5	16.0	7.0	22.5	0.8	C823A473-90****+++
0.056	26.5	16.0	7.0	22.5	0.8	C823A563-90****+++
0.068	26.5	17.0	8.5	22.5	0.8	C823A683-90****+++
0.082	26.5	18.5	10.0	22.5	0.8	C823A823-90****+++
0.10	26.5	18.5	10.0	22.5	0.8	C823A104-90****+++
0.12	26.5	22.0	12.0	22.5	0.8	C823A124-90****+++
0.15	26.5	22.0	12.0	22.5	0.8	C823A154-90****+++
0.10	32.0	18.0	9.0	27.5	0.8	C823A104-B0****+++
0.12	32.0	20.0	11.0	27.5	0.8	C823A124-B0****+++
0.15	32.0	20.0	11.0	27.5	0.8	C823A154-B0****+++
0.18	32.0	22.0	13.0	27.5	0.8	C823A184-B0****+++
0.22	32.0	22.0	13.0	27.5	0.8	C823A224-B0****+++
0.27	32.0	24.5	15.0	27.5	0.8	C823A274-B0****+++
0.33	32.0	28.0	14.0	27.5	0.8	C823A334-B0****+++
0.39	32.0	33.0	18.0	27.5	0.8	C823A394-B0****+++
0.47	32.0	33.0	18.0	27.5	0.8	C823A474-B0****+++

Note: 1. “-”=capacitance tolerance code, M=±20%,K=±10%,J=±5%, H=±3%, G=±2%

2. “****”=lead form and packaging code (refer to table 1)

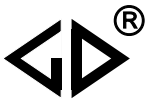

■ Dimensions(mm)

1 600Vdc(650Vac)						
C _N (μF)	W ±0.4	H ±0.4	T ±0.4	P ±0.4	d ±0.05	Part number
0.00068	17.5	11.0	5.0	15.0	0.8	C823C681-60****+++
0.00082	17.5	11.0	5.0	15.0	0.8	C823C821-60****+++
0.0010	17.5	11.0	5.0	15.0	0.8	C823C102-60****+++
0.0012	17.5	11.0	5.0	15.0	0.8	C823C122-60****+++
0.0015	17.5	11.0	5.0	15.0	0.8	C823C152-60****+++
0.0018	17.5	11.0	5.0	15.0	0.8	C823C182-60****+++
0.0022	17.5	11.0	5.0	15.0	0.8	C823C222-60****+++
0.0027	17.5	11.0	5.0	15.0	0.8	C823C272-60****+++
0.0033	17.5	11.0	5.0	15.0	0.8	C823C332-60****+++
0.0039	17.5	11.0	5.0	15.0	0.8	C823C392-60****+++
0.0047	17.5	11.0	5.0	15.0	0.8	C823C472-60****+++
0.0056	17.5	11.0	5.0	15.0	0.8	C823C562-60****+++
0.0068	17.5	11.0	5.0	15.0	0.8	C823C682-60****+++
0.0082	17.5	12.0	6.0	15.0	0.8	C823C822-60****+++
0.010	17.5	12.0	6.0	15.0	0.8	C823C103-60****+++
0.012	17.5	13.5	7.5	15.0	0.8	C823C123-60****+++
0.015	17.5	13.5	7.5	15.0	0.8	C823C153-60****+++
0.018	17.5	14.5	8.5	15.0	0.8	C823C183-60****+++
0.022	17.5	14.5	8.5	15.0	0.8	C823C223-60****+++
0.027	17.5	16.0	10.0	15.0	0.8	C823C273-60****+++
0.033	17.5	19.0	11.0	15.0	0.8	C823C333-60****+++

1 600Vdc(650Vac)						
C _N (μF)	W ±0.4	H ±0.4	T ±0.4	P ±0.4	d ±0.05	Part number
0.015	26.5	15.0	6.0	22.5	0.8	C823C153-90****+++
0.018	26.5	15.0	6.0	22.5	0.8	C823C183-90****+++
0.022	26.5	15.0	6.0	22.5	0.8	C823C223-90****+++
0.027	26.5	15.0	6.0	22.5	0.8	C823C273-90****+++
0.033	26.5	16.0	7.0	22.5	0.8	C823C333-90****+++
0.039	26.5	17.0	8.5	22.5	0.8	C823C393-90****+++
0.047	26.5	18.5	10.0	22.5	0.8	C823C473-90****+++
0.056	26.5	18.5	10.0	22.5	0.8	C823C563-90****+++
0.068	26.5	22.0	12.0	22.5	0.8	C823C683-90****+++
0.082	26.5	22.0	12.0	22.5	0.8	C823C823-90****+++
0.039	32.0	18.0	9.0	27.5	0.8	C823C393-B0****+++
0.047	32.0	18.0	9.0	27.5	0.8	C823C473-B0****+++
0.056	32.0	18.0	9.0	27.5	0.8	C823C563-B0****+++
0.068	32.0	18.0	9.0	27.5	0.8	C823C683-B0****+++
0.082	32.0	20.0	11.0	27.5	0.8	C823C823-B0****+++
0.10	32.0	20.0	11.0	27.5	0.8	C823C104-B0****+++
0.12	32.0	22.0	13.0	27.5	0.8	C823C124-B0****+++
0.15	32.0	24.5	15.0	27.5	0.8	C823C154-B0****+++
0.18	32.0	24.5	15.0	27.5	0.8	C823C184-B0****+++
0.22	32.0	33.0	18.0	27.5	0.8	C823C224-B0****+++
0.27	32.0	33.0	18.0	27.5	0.8	C823C274-B0****+++
0.33	32.0	33.0	18.0	27.5	0.8	C823C334-B0****+++

Note: 1. “-”=capacitance tolerance code, M=±20%, K=±10%,J=±5%, H=±3%, G=±2%

2. “****”=lead form and packaging code (refer to table 1)

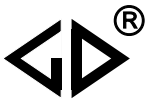

■ Dimensions(mm)

2 000Vdc(700Vac)						
C _N (μF)	W ±0.4	H ±0.4	T ±0.4	P ±0.4	d ±0.05	Part number
0.00022	17.5	11.0	5.0	15.0	0.8	C823D221-60*****++
0.00027	17.5	11.0	5.0	15.0	0.8	C823D271-60*****++
0.00033	17.5	11.0	5.0	15.0	0.8	C823D331-60*****++
0.00039	17.5	11.0	5.0	15.0	0.8	C823D391-60*****++
0.00047	17.5	11.0	5.0	15.0	0.8	C823D471-60*****++
0.00056	17.5	11.0	5.0	15.0	0.8	C823D561-60*****++
0.00068	17.5	11.0	5.0	15.0	0.8	C823D681-60*****++
0.00082	17.5	11.0	5.0	15.0	0.8	C823D821-60*****++
0.0010	17.5	11.0	5.0	15.0	0.8	C823D102-60*****++
0.0012	17.5	11.0	5.0	15.0	0.8	C823D122-60*****++
0.0015	17.5	11.0	5.0	15.0	0.8	C823D152-60*****++
0.0018	17.5	11.0	5.0	15.0	0.8	C823D182-60*****++
0.0022	17.5	11.0	5.0	15.0	0.8	C823D222-60*****++
0.0027	17.5	11.0	5.0	15.0	0.8	C823D272-60*****++
0.0033	17.5	12.0	6.0	15.0	0.8	C823D332-60*****++
0.0039	17.5	12.0	6.0	15.0	0.8	C823D392-60*****++
0.0047	17.5	12.0	6.0	15.0	0.8	C823D472-60*****++
0.0056	17.5	13.5	7.5	15.0	0.8	C823D562-60*****++
0.0068	17.5	13.5	7.5	15.0	0.8	C823D682-60*****++
0.0082	17.5	14.5	8.5	15.0	0.8	C823D822-60*****++
0.010	17.5	16.0	10.0	15.0	0.8	C823D103-60*****++
0.012	17.5	16.0	10.0	15.0	0.8	C823D123-60*****++
0.015	17.5	19.0	11.0	15.0	0.8	C823D153-60*****++

2 000Vdc(700Vac)						
C _N (μF)	W ±0.4	H ±0.4	T ±0.4	P ±0.4	d ±0.05	Part number
0.0010	26.5	15.0	6.0	22.5	0.8	C823D102-90*****++
0.0012	26.5	15.0	6.0	22.5	0.8	C823D122-90*****++
0.0015	26.5	15.0	6.0	22.5	0.8	C823D152-90*****++
0.0018	26.5	15.0	6.0	22.5	0.8	C823D182-90*****++
0.0022	26.5	15.0	6.0	22.5	0.8	C823D222-90*****++
0.0027	26.5	15.0	6.0	22.5	0.8	C823D272-90*****++
0.0033	26.5	15.0	6.0	22.5	0.8	C823D332-90*****++
0.0039	26.5	15.0	6.0	22.5	0.8	C823D392-90*****++
0.0047	26.5	15.0	6.0	22.5	0.8	C823D472-90*****++
0.0056	26.5	15.0	6.0	22.5	0.8	C823D562-90*****++
0.0068	26.5	15.0	6.0	22.5	0.8	C823D682-90*****++
0.0082	26.5	15.0	6.0	22.5	0.8	C823D822-90*****++
0.010	26.5	15.0	6.0	22.5	0.8	C823D103-90*****++
0.012	26.5	15.0	6.0	22.5	0.8	C823D123-90*****++
0.015	26.5	16.0	7.0	22.5	0.8	C823D153-90*****++
0.018	26.5	16.0	7.0	22.5	0.8	C823D183-90*****++
0.022	26.5	17.0	8.5	22.5	0.8	C823D223-90*****++
0.027	26.5	18.5	10.0	22.5	0.8	C823D273-90*****++
0.033	26.5	18.5	10.0	22.5	0.8	C823D333-90*****++
0.039	26.5	22.0	12.0	22.5	0.8	C823D393-90*****++
0.047	26.5	22.0	12.0	22.5	0.8	C823D473-90*****++
0.022	32.0	18.0	9.0	27.5	0.8	C823D223-B0*****++
0.027	32.0	18.0	9.0	27.5	0.8	C823D273-B0*****++
0.033	32.0	18.0	9.0	27.5	0.8	C823D333-B0*****++
0.039	32.0	20.0	11.0	27.5	0.8	C823D393-B0*****++
0.047	32.0	20.0	11.0	27.5	0.8	C823D473-B0*****++
0.056	32.0	22.0	13.0	27.5	0.8	C823D563-B0*****++
0.068	32.0	22.0	13.0	27.5	0.8	C823D683-B0*****++
0.082	32.0	24.5	15.0	27.5	0.8	C823D823-B0*****++
0.10	32.0	28.0	14.0	27.5	0.8	C823D104-B0*****++
0.12	32.0	33.0	18.0	27.5	0.8	C823D124-B0*****++
0.15	32.0	33.0	18.0	27.5	0.8	C823D154-B0*****++

Note: 1. “-”=capacitance tolerance code, M=±20%,K=±10%,J=±5%, H=±3%, G=±2%

2. “****”=lead form and packaging code (refer to table 1)



■ MAX. VOLTAGE(Vr.m.s) VERSUS FREQUENCY

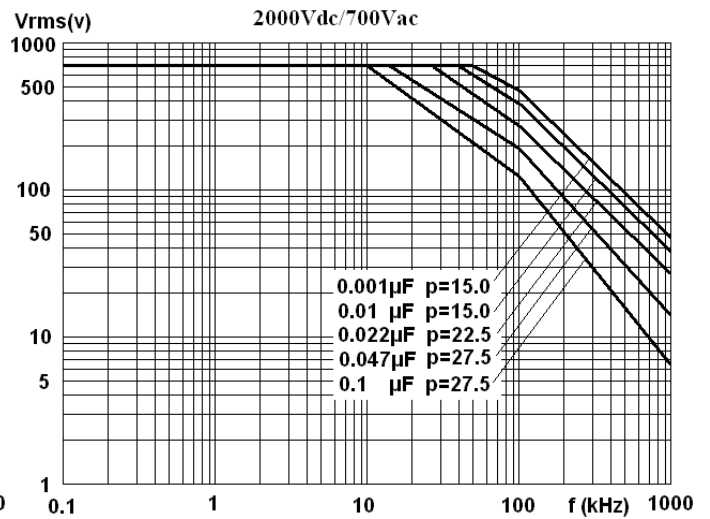
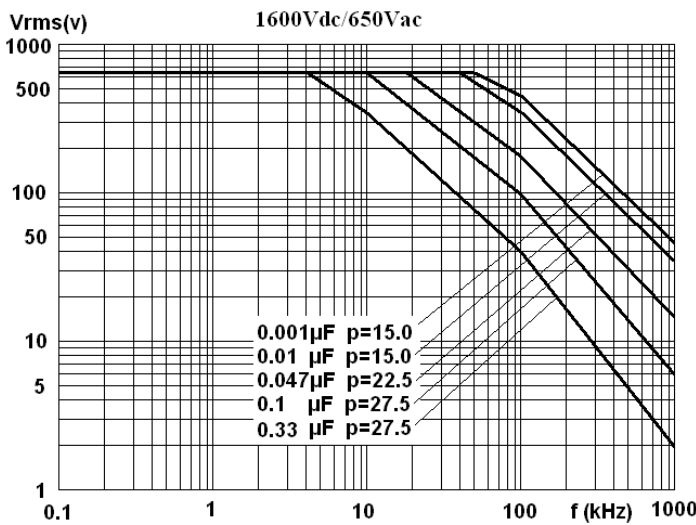
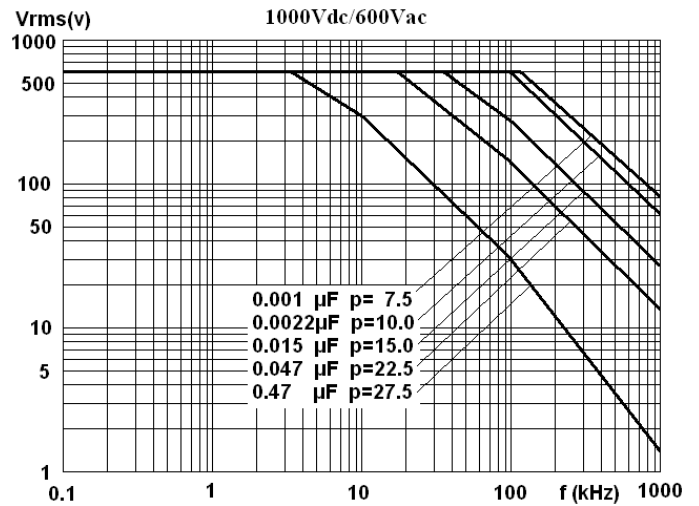
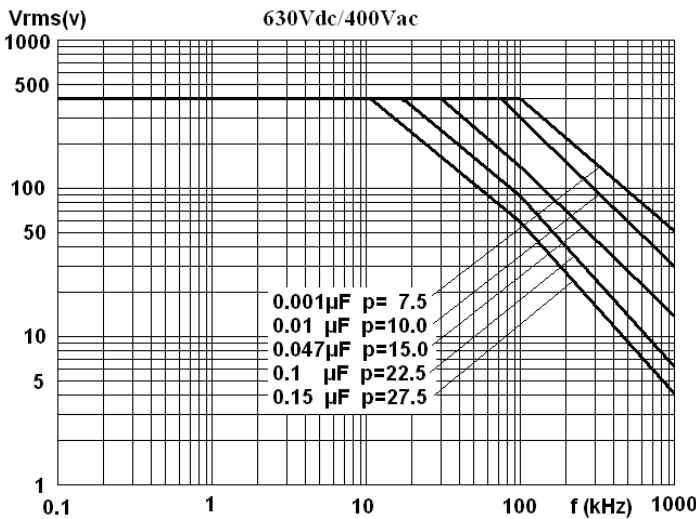
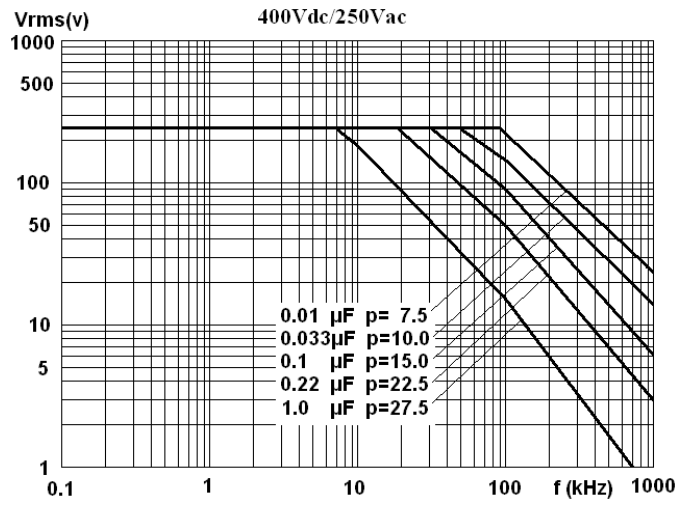
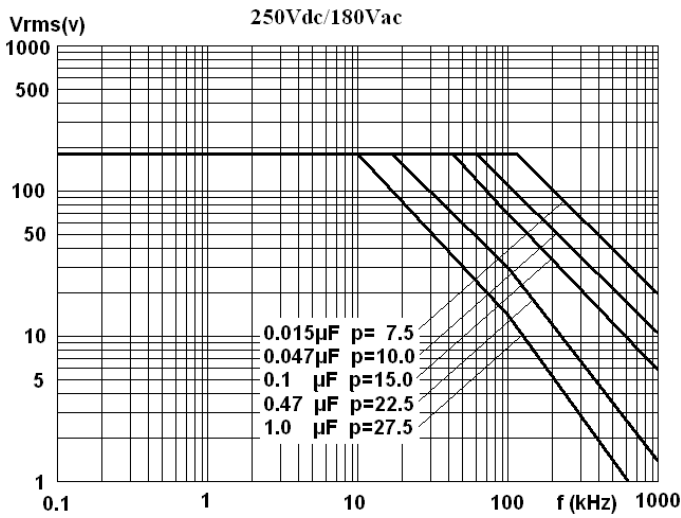

Note: sinusoidal wave-form, environment temperature $\leq 85^{\circ}\text{C}$, internal temperature rise $\Delta T = 10^{\circ}\text{C}$, p (pitch) in mm..

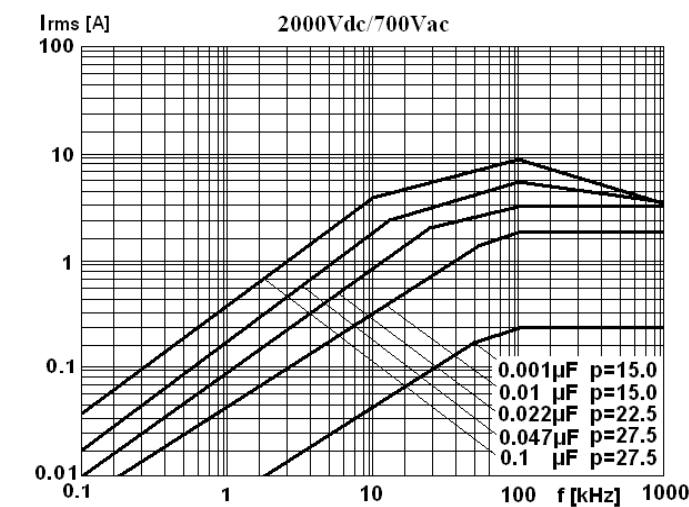
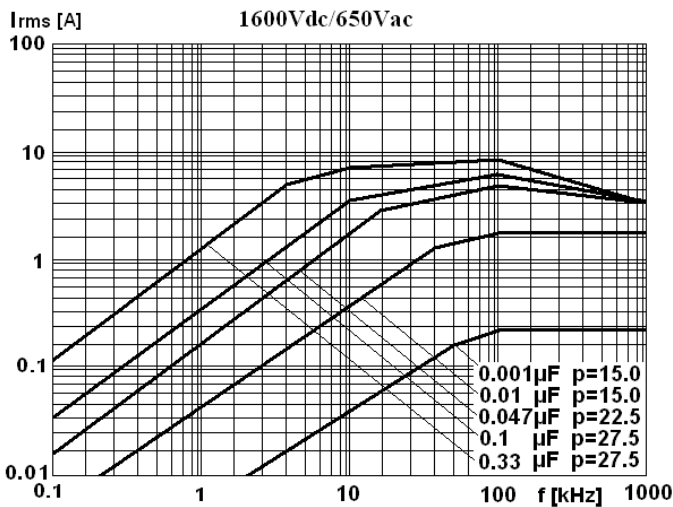
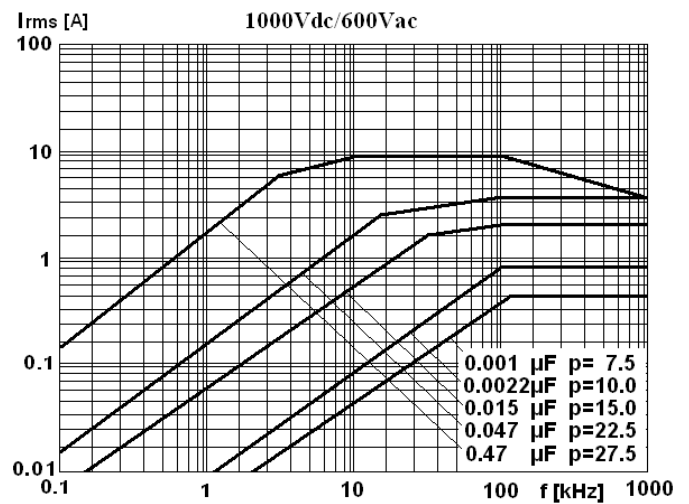
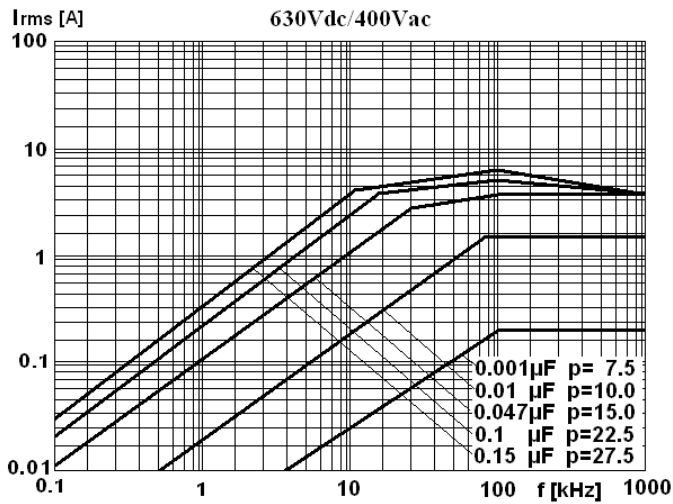
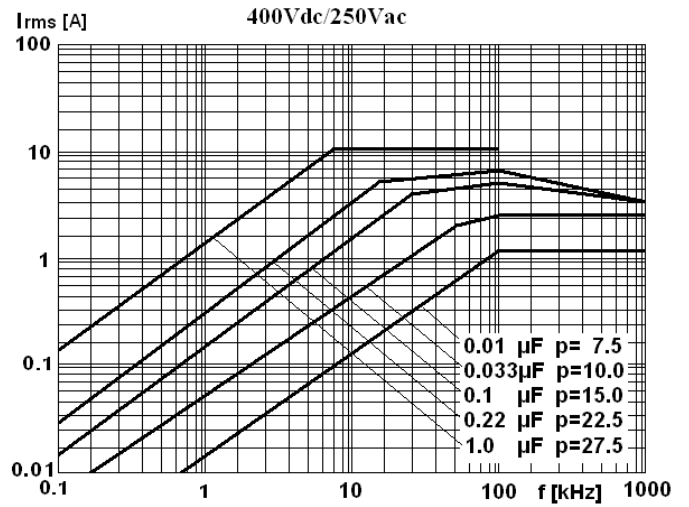
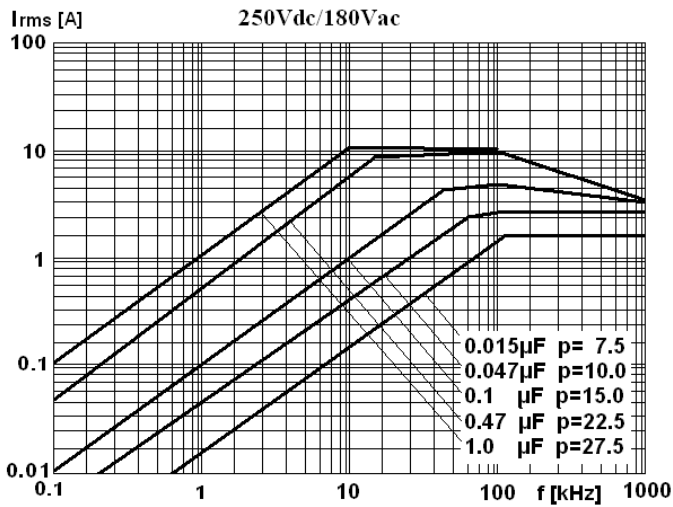
■ MAX. CURRENT(I_{r.m.s}) VERSUS FREQUENCY

Note: sinusoidal wave-form, environment temperature $\leq 85^{\circ}\text{C}$, internal temperature rise $\Delta T=10^{\circ}\text{C}$, p (pitch) in mm.

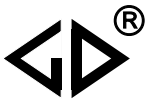

■ Test Method And Performance

No.	Item	Performance	Test method(IEC 60384-16)	
1	Solderability	Good quality of tinning	Solder temperature: 245°C ±5°C Immersion time: 2.0s±0.5s	
2	Initial measurement	Capacitance Tgδ: 1kHz, C>1.0μF 10kHz, C≤1.0μF		
	Terminal strength	There shall be no visible damage	Tense: 0.50<d≤0.80, 10N 0.80<d≤1.25, 20N Bend: 0.50<d≤0.80, 5N 0.80<d≤1.25, 10N The terminals shall be bent 2 times in each direction	
	Resistance to solder heat	There shall be no visible damage, legible marking	Solder temperature:260°C±5°C Immersion time: 10s±1s	
	Final measurement	ΔC/C ≤±2%(relative to the initial value) Increase of tgδ: ≤0.002 (10kHz,C≤1.0μF) ≤0.002 (1kHz, C>1.0μF)		
3	Initial measurement	Capacitance Tgδ(10kHz)		
	Rapid change of temperature	There shall be no evidence of deterioration.	θ _A =-40°C, θ _B =+105°C 5 cycles Duration: t=30min	
	Vibration	There shall be no evidence of deterioration.	Amplitude 0.75mm or acceleration 98m/s ² (whichever is the smaller severity), f: 10Hz to 500Hz.Three directions, 2h for each direction, total 6h.	
	Bump	There shall be no evidence of deterioration.	4 000 times, Acceleration: 390m/s ² ,Pulse duration, 6ms	
	Final measurement	There shall be no visible damage ΔC/C ≤±2%(relative to the initial value) Increase of tgδ: ≤0.002 (10kHz) IR: ≥ 50% of the rated value		
4	Climate sequence	Initial measurement	Capacitance Tgδ: 10kHz	
		Dry heat	+105°C, 16h	
		Damp heat, Cyclic	Test Db, Severity: b, the first cycle	
		Cold	-40°C, 2h	
		Low air pressure	There shall be no permanent breakdown, flashover or other harmful deformation when applying U _R at the last 1 minute.	15°C~35°C, 8.5kPa, 1h
		Damp heat, cyclic other	Applying U _R for 1 minute after 15 minutes the test finished .	Test Db, Severity b, the other cycles,
		Final measurement	There shall be no visible damage, legible marking ΔC/C ≤±3%(relative to the initial value) Increase of tgδ:≤0.003(10kHz) I.R.: ≥ 50% of the rated value	



No.	Item	Performance	Test method(IEC 60384-16)
5	Damp heat steady state	There shall be no visible damage, legible marking $\Delta C/C \leq \pm 5\%$ (relative to the initial value) Increase of $\text{tg}\delta: \leq 0.002$ (10kHz) I.R.: $\geq 50\%$ of the rated value	Temperature: $40^\circ\text{C} \pm 2^\circ\text{C}$ Humidity: $93 \pm 2\%$ RH Duration: 56 days
6	Endurance	There shall be no visible damage, legible marking $\Delta C/C \leq \pm 5\%$ (relative to the initial value) Increase of $\text{tg}\delta: \leq 0.0015$ (10kHz) I.R.: $\geq 50\%$ of the rated value	Temperature: $+85^\circ\text{C}$ Voltage: $1.25 \times U_R$ (50Hz) Duration: 1 000h
7	Temperature characteristic	Measuring capacitance at test point b, d, f: Characteristic at lower category temperature -40°C : $0 \leq (C_b - C_d)/C_d \leq +3\%$ Characteristic at upper category temperature $+105^\circ\text{C}$: $-4\% \leq (C_f - C_d)/C_d \leq 0$ I.R. (test at point f): $IR \geq 2500M\Omega$ $C_R \leq 0.33 \mu\text{F}$ $IR \geq 750s$ $C_R > 0.33 \mu\text{F}$	Static method: The Capacitors should be kept at the following temperature in turn: a(20 ± 2) $^\circ\text{C}$, b(-40 ± 3) $^\circ\text{C}$, d(20 ± 2) $^\circ\text{C}$, f(105 ± 2) $^\circ\text{C}$, g(20 ± 2) $^\circ\text{C}$
8	Charging and discharging	$\Delta C/C \leq \pm 5\%$ (relative to the initial value) increase of $\text{tg}\delta: \leq 0.005$ (10kHz) I.R.: $\geq 50\%$ of the rated value	Times: 10 000 Duration of charging: 0.5s Duration of discharging: 0.5s Charging voltage: rated voltage U_R Charging resistance: $220/C_R (\Omega)$ Discharging resistance: $U_R \div C_R \div dV/dt (\Omega)$ C_R : rated capacitance (μF) dV/dt value: see page 9 table
9	Passive flammability	The flaming time of each capacitor shall not go beyond 30s after it is taken apart from the flame. Drop of each capacitor caused by flame shall not fire the tissue below	IEC 695-2-2 Needle flame test The category of passive flammability: C, Expose time in flame: 1 time Capacitor volume Exposing time $V \leq 250\text{mm}^3$ 5s $250\text{mm}^3 < V \leq 500\text{mm}^3$ 10s $500\text{mm}^3 < V \leq 1750\text{mm}^3$ 20s $V > 1750\text{mm}^3$ 30s

■ Quality ensuring test (before shipment):

Inspection item (each batch)	Inspection level (GB 2828)	
	IL	AQL
Appearance inspection	II	1.5%
Dimensions		
Capacitance	II	0.65%
Tangent of the loss angle		
Dielectric strength		
Insulation resistance		
Solderability	S-3	2.5%

■ Marking

■ Taping specification for box-type capacitors
▲ Outline Drawing

Fig.1 P=5.0、7.5mm

Fig.2 P=10.0、15.0mm

▲ Taping Dimensions(mm)

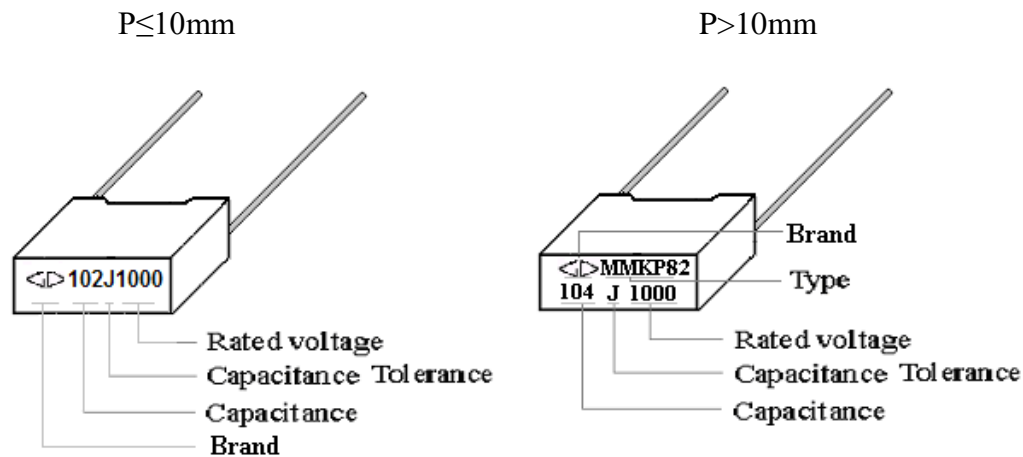
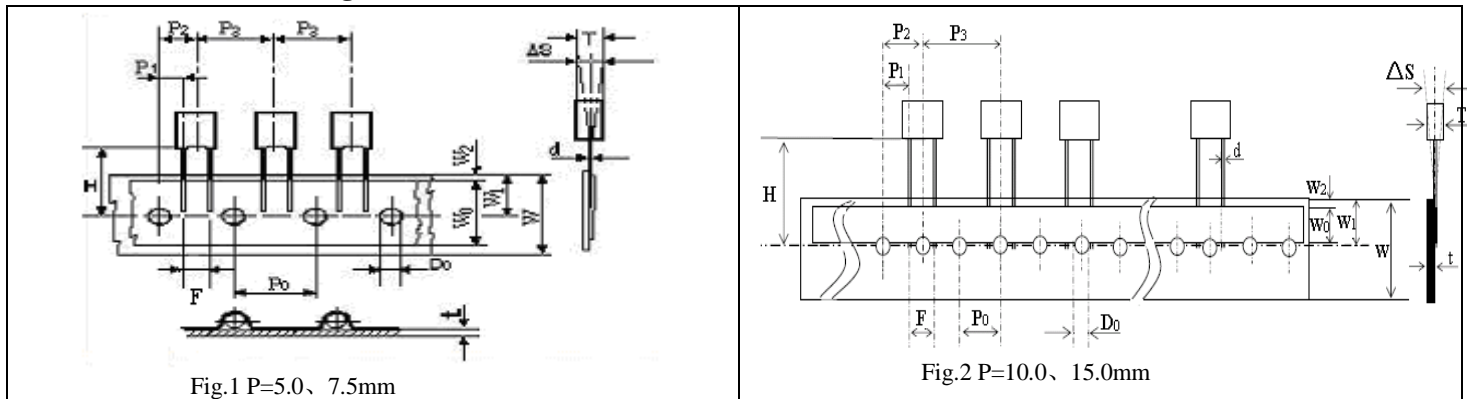
Technology index title	Code	Dimensions				Tolerance
		P=5.0	P=7.5	P=10.0	P=15.0	
Taping type	—	Fig 1	Fig 1	Fig2	Fig 2	—
Part number Digit12-15	Ammo-pack	A201	A301	A405	A605	
Taping pitch	P ₃	12.7	12.7	25.4	25.4	±1.0
Feed hole pitch	P ₀	12.7	12.7	12.7	12.7	±0.2
Center of wire	P ₁	3.85	2.6	7.7	5.2	±0.7
Center of body	P ₂	6.35	6.35	12.7	12.7	±1.3
Pitch of taping wire	F**	5.0	7.5	10.0	15.0	+0.6 -0.1
Component alignment	ΔS	0	0	0	0	±2.0
Height of component from tape center	H***	18.5	18.5	18.5	18.5	±0.5
Carrier tape width	W	18.0	18.0	18.0	18.0	+1.0 -0.5
Hold down tape width	W ₀	6min	10min	10min	10min	—
Hole position	W ₁	9.0	9.0	9.0	9.0	±0.5
Hold down tape position	W ₂	3max	3max	3max	3max	—
Feed hole dia.	D ₀	4.0	4.0	4.0	4.0	±0.2
Tape thickness	t	0.7	0.7	0.7	0.9	±0.2

▲ Packing Quantity

Pitch (mm)	Box thickness T(mm)	Ammo-pack (pcs/box)	
		Domestic	Export
5.0	2.5	2500	2 000
	3.5	1 700	1 500
	4.5	1 400	1 300
	5.0	1 200	1 000
7.5	6.0	1 000	800
	3.5	1 700	1 500
	4.0	1 500	1 300
	5.0	1 200	1 000
10.0/ 15.0	6.0	1 000	800
	4.0	750	650
	5.0	600	500
15.0	6.0	500	450
	7.5	400	350
	8.5	350	300
	10.0	300	250
	11.0	250	200

Note: * P₀=15mm is also available;

**F can be other lead spacing;

***H=16.5mm is available;

■ Packing box sizes(mm)

1. Out packing box for bulk

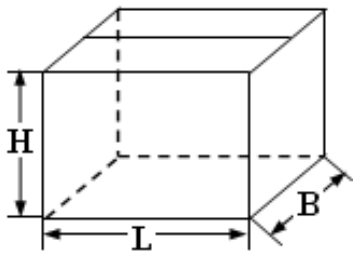

L:375±5
B:375±5
H:265±5

2. Inner packing box for bulk

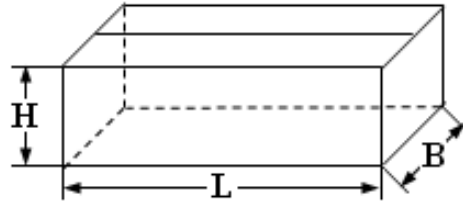

L:355±3
B:175±3
H:118±3

3. Box sizes for Ammo-pack

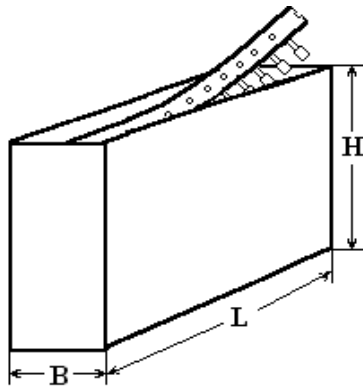

L:330±3
B:48±3
H:260±3

X-ON Electronics

Largest Supplier of Electrical and Electronic Components

Click to view similar products for [faratronic](#) manufacturer:

Other Similar products are found below :

[C42Q2225K9SC000](#) [C312J105JB2C000](#) [C42P2474K9SCB5A](#) [C823A223J60C000](#) [C163L474J0A2000](#) [C43Q1224K9SC000](#)
[C823D822J60Q350](#) [C212A475K9AC000](#) [C323A683K60C000](#) [C43Q1472M40C000](#) [C242A105J2SC000](#) [C222S105J60C000](#)
[C4BQ2475MBWC500](#) [C42Q2225MBSC000](#) [C43Q1103K40C000](#) [C352J333J40C000](#) [C241J105J2SA201](#) [D43Q1224KB0C000](#)
[C222S105J60Y350](#) [C823A104J90C000](#) [C823A563J90C000](#) [C323A104J90C000](#) [C42Q2474K6FC450](#) [C4BQ2225MBWC000](#)
[C42Q2334K6SC000](#) [C43Q1103K6SC000](#) [C823D471J60C350](#) [C42Q2475MBFC500](#) [C312E474J6SC000](#) [C322J104J60Q350](#)
[C42Q2105M9SC000](#) [C3D1U506KFAA382](#) [C322E225K90C000](#) [C6AQ1475JB20000](#) [C42Q2224M6SC000](#) [C242A474J2SA201](#)
[C42Q2473M4SC000](#) [C352J473J40C000](#) [C42P2475KB0C000](#) [C42Q2474K6FC000](#) [C42Q2224K6SC000](#) [C222S154J40A40E](#)
[C222T105K90C000](#) [C312A105J6SC000](#) [C252A475J60C322](#) [C42Q2335KBAC350](#) [C42P2225K9SC000](#) [C322E224K40C000](#)
[C222J105J90C000](#) [C823C103J60C350](#)