



Aludruckguss-Kombischarnier 25

Die-cast Aluminum Combi Hinge 25

Beschreibung nicht aushängbar
für Flächenelemente und Aluminiumprofile, mit je einem Steckplatz für Zentrierbolzen

Material Flügel: Aluminiumdruckguss
Achse: Edelstahl
Zentrierbolzen (optional): Kunststoff PA, glasfaserverstärkt

Oberfläche alufarbig lackiert

Befestigung vorderseitig mit Senkschrauben M6

Liefereinheit 10 Stück

Description *Non-detachable*
To hinge panels or aluminum profiles, each with a hole for centering bolts

Material *Wings: Die-cast-aluminum*
Pin: Stainless steel
Centering bolt (optional): Nylon PA, glass fibre reinforced

Surface *Alu color laquered*

Fastening *From the front, using M6 countersunk screws*

Pack Quantity *10 pieces*

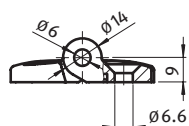
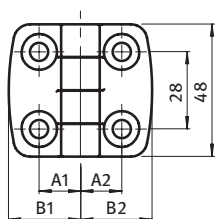

Scharnier Hinge	Bezeichnung Description	A1 [mm]	A2 [mm]	B1 [mm]	B2 [mm]	Gewicht [g] Weight [g]	F _{Amax} [N]	F _{Rmax} [N]	Teil-Nr. Part #
nicht aushängbar <i>Non-detachable</i>	25/25	15.0	15.0	26.0	26.0	57.0	215	275	095A2525F
	25/30	15.0	17.5	26.0	29.5	61.0	225	325	095A2530F
	25/35	15.0	20.0	26.0	36.0	65.0	225	325	095A2535F
	25/40	15.0	22.5	26.0	38.5	63.0	250	400	095A2540F
	25/45	15.0	25.0	26.0	43.5	65.0	250	400	095A2545F
	25/50	15.0	27.5	26.0	48.5	68.0	250	400	095A2550F
	25/60	15.0	32.5	26.0	57.5	73.0	100	400	095A2560F
Zentrierbolzen <i>Centering bolt</i>	Nut 5 Slot 5	-	-	-	-	1.0	-	-	095AN05
	Nut 6 Slot 6	-	-	-	-	1.0	-	-	095AN06
	Nut 8 Slot 8	-	-	-	-	1.0	-	-	095AN08
	Nut 10 Slot 10	-	-	-	-	1.0	-	-	095AN10
	Nut 12 Slot 12	-	-	-	-	1.0	-	-	095AN12
	Nut 14 Slot 14	-	-	-	-	1.0	-	-	095AN14



Aludruckguss-Kombischarnier 30

Die-cast Aluminum Combi Hinge 30

Beschreibung aushängbar für Flächenelemente und Aluminiumprofile, mit je einem Steckplatz für Zentrierbolzen

Material Flügel: Aluminiumdruckguss
Achse: Edelstahl
Zentrierbolzen (optional): Kunststoff PA, glasfaserverstärkt

Oberfläche alufarbig lackiert

Befestigung vorderseitig mit Senkschrauben M6

Liefereinheit 10 Stück

Description Detachable To hinge panels or aluminum profiles, each with a hole for centering bolts

Material Wings: Die-cast-aluminum
Pin: Stainless steel
Centering bolt (optional): Nylon PA, glass fibre reinforced

Surface Alu color laquered

Fastening From the front, using M6 countersunk screws

Pack Quantity 10 pieces

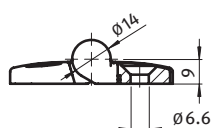
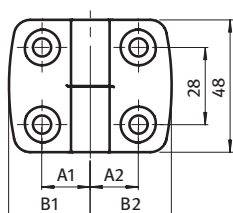

Scharnier Hinge	Bezeichnung Description	A1 [mm]	A2 [mm]	B1 [mm]	B2 [mm]	Gewicht [g] Weight [g]	FMax [N]	FRmax [N]	Teil-Nr. Part #
links left	30/30	17.5	17.5	29.5	29.5	64.0	280	450	095A3030L
	30/25	17.5	15.0	29.5	26.0	60.0	250	410	095A2530L
	30/35	17.5	20.0	29.5	36.0	68.0	250	500	095A3035L
	30/40	17.5	22.5	29.5	38.5	66.0	200	550	095A3040L
	30/45	17.5	25.0	29.5	43.5	68.0	200	550	095A3045L
	30/50	17.5	27.5	29.5	48.5	71.0	175	575	095A3050L
rechts right	30/60	17.5	32.5	29.5	57.5	76.0	150	575	095A3060L
	30/30	17.5	17.5	29.5	29.5	64.0	280	450	095A3030R
	30/25	17.5	15.0	29.5	26.0	60.0	250	410	095A2530R
	30/35	17.5	20.0	29.5	36.0	68.0	250	500	095A3035R
	30/40	17.5	22.5	29.5	38.5	66.0	200	550	095A3040R
	30/45	17.5	25.0	29.5	43.5	68.0	200	550	095A3045R
Zentrierbolzen Centering bolt	30/50	17.5	27.5	29.5	48.5	71.0	175	575	095A3050R
	30/60	17.5	32.5	29.5	57.5	76.0	150	575	095A3060R
	Nut 5 Slot 5	-	-	-	-	1.0	-	-	095AN05
	Nut 6 Slot 6	-	-	-	-	1.0	-	-	095AN06
	Nut 8 Slot 8	-	-	-	-	1.0	-	-	095AN08
	Nut 10 Slot 10	-	-	-	-	1.0	-	-	095AN10
Nut 12 Slot 12	-	-	-	-	1.0	-	-	095AN12	
Nut 14 Slot 14	-	-	-	-	1.0	-	-	095AN14	



Aludruckguss-Kombischarnier 30

Die-cast Aluminum Combi Hinge 30

Beschreibung nicht aushängbar
für Flächenelemente und Aluminiumprofile, mit je einem Steckplatz für Zentrierbolzen

Material Flügel: Aluminiumdruckguss
Achse: Edelstahl
Zentrierbolzen (optional): Kunststoff PA, glasfaserverstärkt

Oberfläche alufarbig lackiert

Befestigung vorderseitig mit Senkschrauben M6

Liefereinheit 10 Stück

Description *Non-detachable*
To hinge panels or aluminum profiles, each with a hole for centering bolts

Material *Wings: Die-cast-aluminum*
Pin: Stainless steel
Centering bolt (optional): Nylon PA, glass fibre reinforced

Surface *Alu color laquered*

Fastening *From the front, using M6 countersunk screws*

Pack Quantity *10 pieces*

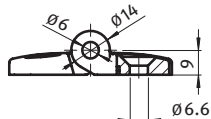
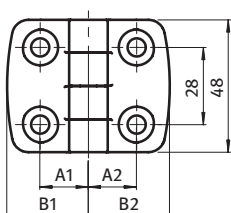

Scharnier Hinge	Bezeichnung Description	A1 [mm]	A2 [mm]	B1 [mm]	B2 [mm]	Gewicht [g] Weight [g]	F _{Amax} [N]	F _{Rmax} [N]	Teil-Nr. Part #
nicht aushängbar Non-detachable	30/30	17.5	17.5	29.5	29.5	65.0	225	325	095A3030F
	30/25	17.5	15.0	29.5	26.0	61.0	215	275	095A2530F
	30/35	17.5	20.0	29.5	36.0	69.0	225	325	095A3035F
	30/40	17.5	22.5	29.5	38.5	67.0	250	400	095A3040F
	30/45	17.5	25.0	29.5	43.5	69.0	250	400	095A3045F
	30/50	17.5	27.5	29.5	48.5	72.0	250	400	095A3050F
	30/60	17.5	32.5	29.5	57.5	77.0	100	400	095A3060F
Zentrierbolzen Centering bolt	Nut 5 Slot 5	-	-	-	-	1.0	-	-	095AN05
	Nut 6 Slot 6	-	-	-	-	1.0	-	-	095AN06
	Nut 8 Slot 8	-	-	-	-	1.0	-	-	095AN08
	Nut 10 Slot 10	-	-	-	-	1.0	-	-	095AN10
	Nut 12 Slot 12	-	-	-	-	1.0	-	-	095AN12
	Nut 14 Slot 14	-	-	-	-	1.0	-	-	095AN14



Aludruckguss-Kombischarnier 35

Die-cast Aluminum Combi Hinge 35

Beschreibung aushängbar für Flächenelemente und Aluminiumprofile, mit je einem Steckplatz für Zentrierbolzen

Material Flügel: Aluminiumdruckguss
Achse: Edelstahl
Zentrierbolzen (optional): Kunststoff PA, glasfaserverstärkt

Oberfläche alufarbig lackiert

Befestigung vorderseitig mit Senkschrauben M6

Liefereinheit 10 Stück

Description Detachable To hinge panels or aluminum profiles, each with a hole for centering bolts

Material Wings: Die-cast-aluminum
Pin: Stainless steel
Centering bolt (optional): Nylon PA, glass fibre reinforced

Surface Alu color laquered

Fastening From the front, using M6 countersunk screws

Pack Quantity 10 pieces

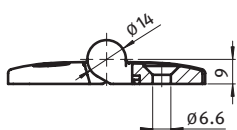
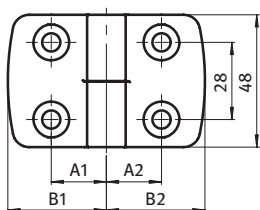

Scharnier Hinge	Bezeichnung Description	A1 [mm]	A2 [mm]	B1 [mm]	B2 [mm]	Gewicht [g] Weight [g]	FMax [N]	FRmax [N]	Teil-Nr. Part #
links left	35/35	20.0	20.0	36.0	36.0	72.0	250	500	095A3535L
	35/25	20.0	15.0	36.0	26.0	64.0	250	410	095A2535L
	35/30	20.0	17.5	36.0	29.5	68.0	280	450	095A3035L
	35/40	20.0	22.5	36.0	38.5	70.0	200	550	095A3540L
	35/45	20.0	25.0	36.0	43.5	72.0	200	550	095A3545L
	35/50	20.0	27.5	36.0	48.5	75.0	175	575	095A3550L
rechts right	35/60	20.0	32.5	36.0	57.5	80.0	150	575	095A3560L
	35/35	20.0	20.0	36.0	36.0	72.0	250	500	095A3535R
	35/25	20.0	15.0	36.0	26.0	64.0	250	410	095A2535R
	35/30	20.0	17.5	36.0	29.5	68.0	280	450	095A3035R
	35/40	20.0	22.5	36.0	38.5	70.0	200	550	095A3540R
	35/45	20.0	25.0	36.0	43.5	72.0	200	550	095A3545R
Zentrierbolzen Centering bolt	35/50	20.0	27.5	36.0	48.5	75.0	175	575	095A3550R
	35/60	20.0	32.5	36.0	57.5	80.0	150	575	095A3560R
	Nut 5 Slot 5	-	-	-	-	1.0	-	-	095AN05
	Nut 6 Slot 6	-	-	-	-	1.0	-	-	095AN06
	Nut 8 Slot 8	-	-	-	-	1.0	-	-	095AN08
	Nut 10 Slot 10	-	-	-	-	1.0	-	-	095AN10
Nut 12 Slot 12	-	-	-	-	1.0	-	-	095AN12	
Nut 14 Slot 14	-	-	-	-	1.0	-	-	095AN14	



Aludruckguss-Kombischarnier 35

Die-cast Aluminum Combi Hinge 35

Beschreibung nicht aushängbar
für Flächenelemente und Aluminiumprofile, mit je einem Steckplatz für Zentrierbolzen

Material Flügel: Aluminiumdruckguss
Achse: Edelstahl
Zentrierbolzen (optional): Kunststoff PA, glasfaserverstärkt

Oberfläche alufarbig lackiert

Befestigung vorderseitig mit Senkschrauben M6

Liefereinheit 10 Stück

Description *Non-detachable*
To hinge panels or aluminum profiles, each with a hole for centering bolts

Material *Wings: Die-cast-aluminum*
Pin: Stainless steel
Centering bolt (optional): Nylon PA, glass fibre reinforced

Surface *Alu color laquered*

Fastening *From the front, using M6 countersunk screws*

Pack Quantity *10 pieces*

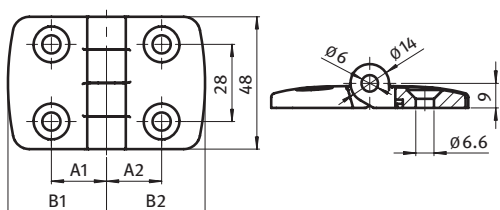

Scharnier Hinge	Bezeichnung Description	A1 [mm]	A2 [mm]	B1 [mm]	B2 [mm]	Gewicht [g] Weight [g]	F _{Amax} [N]	F _{Rmax} [N]	Teil-Nr. Part #
nicht aushängbar <i>Non-detachable</i>	35/35	20.0	20.0	36.0	36.0	73.0	225	325	095A3535F
	35/25	20.0	15.0	36.0	26.0	65.0	225	325	095A2535F
	35/30	20.0	17.5	36.0	29.5	69.0	225	325	095A3035F
	35/40	20.0	22.5	36.0	38.5	71.0	250	400	095A3540F
	35/45	20.0	25.0	36.0	43.5	73.0	250	400	095A3545F
	35/50	20.0	27.5	36.0	48.5	76.0	250	400	095A3550F
	35/60	20.0	32.5	36.0	57.5	81.0	100	400	095A3560F
Zentrierbolzen <i>Centering bolt</i>	Nut 5 <i>Slot 5</i>	-	-	-	-	1.0	-	-	095AN05
	Nut 6 <i>Slot 6</i>	-	-	-	-	1.0	-	-	095AN06
	Nut 8 <i>Slot 8</i>	-	-	-	-	1.0	-	-	095AN08
	Nut 10 <i>Slot 10</i>	-	-	-	-	1.0	-	-	095AN10
	Nut 12 <i>Slot 12</i>	-	-	-	-	1.0	-	-	095AN12
	Nut 14 <i>Slot 14</i>	-	-	-	-	1.0	-	-	095AN14



Aludruckguss-Kombischarnier 40

Die-cast Aluminum Combi Hinge 40

Beschreibung aushängbar für Flächenelemente und Aluminiumprofile, mit je einem Steckplatz für Zentrierbolzen

Material Flügel: Aluminiumdruckguss
Achse: Edelstahl
Zentrierbolzen (optional): Kunststoff PA, glasfaserverstärkt

Oberfläche alufarbig lackiert

Befestigung vorderseitig mit Senkschrauben M6

Liefereinheit 10 Stück

Description Detachable To hinge panels or aluminum profiles, each with a hole for centering bolts

Material Wings: Die-cast-aluminum
Pin: Stainless steel
Centering bolt (optional): Nylon PA, glass fibre reinforced

Surface Alu color laquered

Fastening From the front, using M6 countersunk screws

Pack Quantity 10 pieces

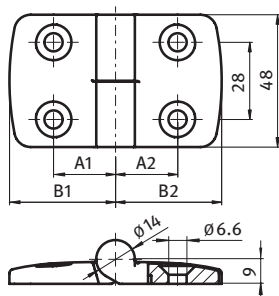

Scharnier Hinge	Bezeichnung Description	A1 [mm]	A2 [mm]	B1 [mm]	B2 [mm]	Gewicht [g] Weight [g]	FMax [N]	FRmax [N]	Teil-Nr. Part #
links left	40/40	22.5	22.5	38.5	38.5	68.0	200	550	095A4040L
	40/25	22.5	15.0	38.5	26.0	62.0	250	410	095A2540L
	40/30	22.5	17.5	38.5	29.5	66.0	280	450	095A3040L
	40/35	22.5	20.0	38.5	36.0	70.0	250	500	095A3540L
	40/45	22.5	25.0	38.5	43.5	70.0	200	550	095A4045L
	40/50	22.5	27.5	38.5	48.5	73.0	175	575	095A4050L
rechts right	40/60	22.5	32.5	38.5	57.5	78.0	150	575	095A4060L
	40/40	22.5	22.5	38.5	38.5	68.0	200	550	095A4040R
	40/25	22.5	15.0	38.5	26.0	62.0	250	410	095A2540R
	40/30	22.5	17.5	38.5	29.5	66.0	280	450	095A3040R
	40/35	22.5	20.0	38.5	36.0	70.0	250	500	095A3540R
	40/45	22.5	25.0	38.5	43.5	70.0	200	550	095A4045R
Zentrierbolzen Centering bolt	40/50	22.5	27.5	38.5	48.5	73.0	175	575	095A4050R
	40/60	22.5	32.5	38.5	57.5	78.0	150	575	095A4060R
	Nut 5 Slot 5	-	-	-	-	1.0	-	-	095AN05
	Nut 6 Slot 6	-	-	-	-	1.0	-	-	095AN06
	Nut 8 Slot 8	-	-	-	-	1.0	-	-	095AN08
	Nut 10 Slot 10	-	-	-	-	1.0	-	-	095AN10
	Nut 12 Slot 12	-	-	-	-	1.0	-	-	095AN12
	Nut 14 Slot 14	-	-	-	-	1.0	-	-	095AN14



Aludruckguss-Kombischarnier 40

Die-cast Aluminum Combi Hinge 40

Beschreibung nicht aushängbar
für Flächenelemente und Aluminiumprofile, mit je einem Steckplatz für Zentrierbolzen

Material Flügel: Aluminiumdruckguss
Achse: Edelstahl
Zentrierbolzen (optional): Kunststoff PA, glasfaserverstärkt

Oberfläche alufarbig lackiert

Befestigung vorderseitig mit Senkschrauben M6

Liefereinheit 10 Stück

Description *Non-detachable*
To hinge panels or aluminum profiles, each with a hole for centering bolts

Material *Wings: Die-cast-aluminum*
Pin: Stainless steel
Centering bolt (optional): Nylon PA, glass fibre reinforced

Surface *Alu color laquered*

Fastening *From the front, using M6 countersunk screws*

Pack Quantity *10 pieces*

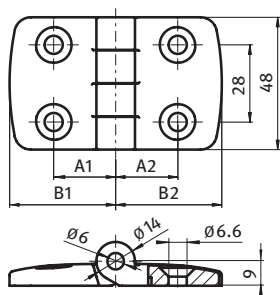

Scharnier Hinge	Bezeichnung Description	A1 [mm]	A2 [mm]	B1 [mm]	B2 [mm]	Gewicht [g] Weight [g]	F _{Amax} [N]	F _{Rmax} [N]	Teil-Nr. Part #
nicht aushängbar <i>Non-detachable</i>	40/40	22.5	22.5	38.5	38.5	69.0	250	400	095A4040F
	40/25	22.5	15.0	38.5	26.0	63.0	215	275	095A2540F
	40/30	22.5	17.5	38.5	29.5	67.0	225	325	095A3040F
	40/35	22.5	20.0	38.5	36.0	71.0	225	325	095A3540F
	40/45	22.5	25.0	38.5	43.5	71.0	250	400	095A4045F
	40/50	22.5	27.5	38.5	48.5	74.0	250	400	095A4050F
	40/60	22.5	32.5	38.5	57.5	79.0	100	400	095A4060F
Zentrierbolzen <i>Centering bolt</i>	Nut 5 Slot 5	-	-	-	-	1.0	-	-	095AN05
	Nut 6 Slot 6	-	-	-	-	1.0	-	-	095AN06
	Nut 8 Slot 8	-	-	-	-	1.0	-	-	095AN08
	Nut 10 Slot 10	-	-	-	-	1.0	-	-	095AN10
	Nut 12 Slot 12	-	-	-	-	1.0	-	-	095AN12
	Nut 14 Slot 14	-	-	-	-	1.0	-	-	095AN14



Aludruckguss-Kombischarnier 45

Die-cast Aluminum Combi Hinge 45

Beschreibung aushängbar für Flächenelemente und Aluminiumprofile, mit je einem Steckplatz für Zentrierbolzen

Material Flügel: Aluminiumdruckguss
Achse: Edelstahl
Zentrierbolzen (optional): Kunststoff PA, glasfaserverstärkt

Oberfläche alufarbig lackiert

Befestigung vorderseitig mit Senkschrauben M6

Liefereinheit 10 Stück

Description Detachable To hinge panels or aluminum profiles, each with a hole for centering bolts

Material Wings: Die-cast-aluminum
Pin: Stainless steel
Centering bolt (optional): Nylon PA, glass fibre reinforced

Surface Alu color laquered

Fastening From the front, using M6 countersunk screws

Pack Quantity 10 pieces

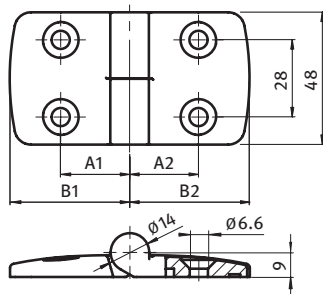

Scharnier Hinge	Bezeichnung Description	A1 [mm]	A2 [mm]	B1 [mm]	B2 [mm]	Gewicht [g] Weight [g]	FMax [N]	FRmax [N]	Teil-Nr. Part #
links left	45/45	25.0	25.0	43.5	43.5	70.0	200	550	095A4545L
	45/25	25.0	15.0	43.5	26.0	64.0	250	410	095A2545L
	45/30	25.0	17.5	43.5	29.5	68.0	280	450	095A3045L
	45/35	25.0	20.0	43.5	36.0	72.0	250	500	095A3545L
	45/40	25.0	22.5	43.5	38.5	70.0	200	550	095A4045L
	45/50	25.0	27.5	43.5	48.5	75.0	175	575	095A4550L
rechts right	45/60	25.0	32.5	43.5	57.5	80.0	150	575	095A4560L
	45/45	25.0	25.0	43.5	43.5	70.0	200	550	095A4545R
	45/25	25.0	15.0	43.5	26.0	64.0	250	410	095A2545R
	45/30	25.0	17.5	43.5	29.5	68.0	280	450	095A3045R
	45/35	25.0	20.0	43.5	36.0	72.0	250	500	095A3545R
	45/40	25.0	22.5	43.5	38.5	70.0	200	550	095A4045R
Zentrierbolzen Centering bolt	45/50	25.0	27.5	43.5	48.5	75.0	175	575	095A4550R
	45/60	25.0	32.5	43.5	57.5	80.0	150	575	095A4560R
	Nut 5 Slot 5	-	-	-	-	1.0	-	-	095AN05
	Nut 6 Slot 6	-	-	-	-	1.0	-	-	095AN06
	Nut 8 Slot 8	-	-	-	-	1.0	-	-	095AN08
	Nut 10 Slot 10	-	-	-	-	1.0	-	-	095AN10
Nut 12 Slot 12	-	-	-	-	1.0	-	-	095AN12	
Nut 14 Slot 14	-	-	-	-	1.0	-	-	095AN14	



Aludruckguss-Kombischarnier 45

Die-cast Aluminum Combi Hinge 45

Beschreibung nicht aushängbar
für Flächenelemente und Aluminiumprofile, mit je einem Steckplatz für Zentrierbolzen

Material Flügel: Aluminiumdruckguss
Achse: Edelstahl
Zentrierbolzen (optional): Kunststoff PA, glasfaserverstärkt

Oberfläche alufarbig lackiert

Befestigung vorderseitig mit Senkschrauben M6

Liefereinheit 10 Stück

Description *Non-detachable*
To hinge panels or aluminum profiles, each with a hole for centering bolts

Material *Wings: Die-cast-aluminum*
Pin: Stainless steel
Centering bolt (optional): Nylon PA, glass fibre reinforced

Surface *Alu color laquered*

Fastening *From the front, using M6 countersunk screws*

Pack Quantity *10 pieces*

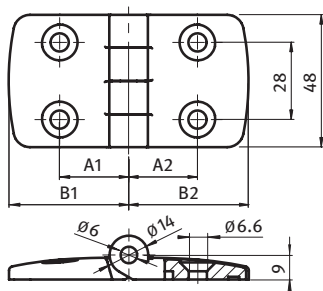

Scharnier Hinge	Bezeichnung Description	A1 [mm]	A2 [mm]	B1 [mm]	B2 [mm]	Gewicht [g] Weight [g]	F _{Amax} [N]	F _{Rmax} [N]	Teil-Nr. Part #
nicht aushängbar <i>Non-detachable</i>	45/45	25.0	25.0	43.5	43.5	73.0	250	400	095A4545F
	45/25	25.0	15.0	43.5	26.0	65.0	215	275	095A2545F
	45/30	25.0	17.5	43.5	29.5	69.0	225	325	095A3045F
	45/35	25.0	20.0	43.5	36.0	73.0	225	325	095A3545F
	45/40	25.0	22.5	43.5	38.5	71.0	250	400	095A4045F
	45/50	25.0	27.5	43.5	48.5	76.0	250	400	095A4550F
	45/60	25.0	32.5	43.5	57.5	81.0	100	400	095A4560F
Zentrierbolzen <i>Centering bolt</i>	Nut 5 <i>Slot 5</i>	-	-	-	-	1.0	-	-	095AN05
	Nut 6 <i>Slot 6</i>	-	-	-	-	1.0	-	-	095AN06
	Nut 8 <i>Slot 8</i>	-	-	-	-	1.0	-	-	095AN08
	Nut 10 <i>Slot 10</i>	-	-	-	-	1.0	-	-	095AN10
	Nut 12 <i>Slot 12</i>	-	-	-	-	1.0	-	-	095AN12
	Nut 14 <i>Slot 14</i>	-	-	-	-	1.0	-	-	095AN14



Aludruckguss-Kombischarnier 50

Die-cast Aluminum Combi Hinge 50

Beschreibung aushängbar für Flächenelemente und Aluminiumprofile, mit je einem Steckplatz für Zentrierbolzen

Material Flügel: Aluminiumdruckguss
Achse: Edelstahl
Zentrierbolzen (optional): Kunststoff PA, glasfaserverstärkt

Oberfläche alufarbig lackiert

Befestigung vorderseitig mit Senkschrauben M6

Liefereinheit 10 Stück

Description Detachable To hinge panels or aluminum profiles, each with a hole for centering bolts

Material Wings: Die-cast-aluminum
Pin: Stainless steel
Centering bolt (optional): Nylon PA, glass fibre reinforced

Surface Alu color laquered

Fastening From the front, using M6 countersunk screws

Pack Quantity 10 pieces

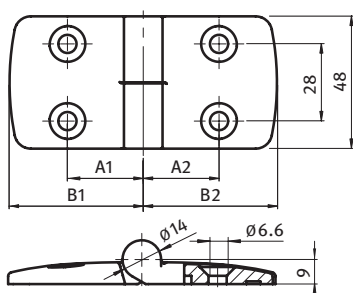

Scharnier Hinge	Bezeichnung Description	A1 [mm]	A2 [mm]	B1 [mm]	B2 [mm]	Gewicht [g] Weight [g]	F _{Amax} [N]	F _{Rmax} [N]	Teil-Nr. Part #
links left	50/50	27.5	27.5	48.5	48.5	78.0	175	550	095A5050L
	50/25	27.5	15.0	48.5	26.0	67.0	250	410	095A2550L
	50/30	27.5	17.5	48.5	29.5	71.0	280	450	095A3050L
	50/35	27.5	20.0	48.5	36.0	75.0	250	500	095A3550L
	50/40	27.5	22.5	48.5	38.5	73.0	200	550	095A4050L
	50/45	27.5	25.0	48.5	43.5	75.0	200	550	095A4550L
rechts right	50/60	27.5	32.5	48.5	57.5	83.0	150	550	095A5060L
	50/25	27.5	15.0	48.5	26.0	67.0	250	410	095A2550R
	50/50	27.5	27.5	48.5	48.5	78.0	175	500	095A5050R
	50/30	27.5	17.5	48.5	29.5	71.0	250	410	095A3050R
	50/35	27.5	20.0	48.5	36.0	75.0	250	500	095A3550R
	50/40	27.5	22.5	48.5	38.5	73.0	200	550	095A4050R
Zentrierbolzen Centering bolt	50/45	27.5	25.0	48.5	43.5	75.0	200	550	095A4550R
	50/60	27.5	32.5	48.5	57.5	83.0	150	550	095A5060R
	Nut 5 Slot 5	-	-	-	-	1.0	-	-	095AN05
	Nut 6 Slot 6	-	-	-	-	1.0	-	-	095AN06
	Nut 8 Slot 8	-	-	-	-	1.0	-	-	095AN08
	Nut 10 Slot 10	-	-	-	-	1.0	-	-	095AN10
Nut 12 Slot 12	-	-	-	-	1.0	-	-	095AN12	
Nut 14 Slot 14	-	-	-	-	1.0	-	-	095AN14	



Aludruckguss-Kombischarnier 50

Die-cast Aluminum Combi Hinge 50

Beschreibung nicht aushängbar
für Flächenelemente und Aluminiumprofile, mit je einem Steckplatz für Zentrierbolzen

Material Flügel: Aluminiumdruckguss
Achse: Edelstahl
Zentrierbolzen (optional): Kunststoff PA, glasfaserverstärkt

Oberfläche alufarbig lackiert

Befestigung vorderseitig mit Senkschrauben M6

Liefereinheit 10 Stück

Description *Non-detachable*
To hinge panels or aluminum profiles, each with a hole for centering bolts

Material *Wings: Die-cast-aluminum*
Pin: Stainless steel
Centering bolt (optional): Nylon PA, glass fibre reinforced

Surface *Alu color laquered*

Fastening *From the front, using M6 countersunk screws*

Pack Quantity *10 pieces*

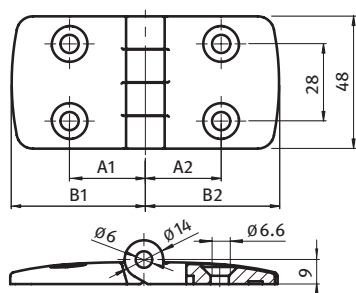

Scharnier Hinge	Bezeichnung Description	A1 [mm]	A2 [mm]	B1 [mm]	B2 [mm]	Gewicht [g] Weight [g]	F _{Amax} [N]	F _{Rmax} [N]	Teil-Nr. Part #
nicht aushängbar <i>Non-detachable</i>	50/50	27.5	27.5	48.5	48.5	79.0	250	400	095A5050F
	50/25	27.5	15.0	48.5	26.0	68.0	215	275	095A2550F
	50/30	27.5	17.5	48.5	29.5	72.0	225	325	095A3050F
	50/35	27.5	20.0	48.5	36.0	76.0	225	325	095A3550F
	50/40	27.5	22.5	48.5	38.5	74.0	250	400	095A4050F
	50/45	27.5	25.0	48.5	43.5	76.0	250	400	095A4550F
	50/60	27.5	32.5	48.5	57.5	84.0	250	400	095A5060F
Zentrierbolzen <i>Centering bolt</i>	Nut 5 <i>Slot 5</i>	-	-	-	-	1.0	-	-	095AN05
	Nut 6 <i>Slot 6</i>	-	-	-	-	1.0	-	-	095AN06
	Nut 8 <i>Slot 8</i>	-	-	-	-	1.0	-	-	095AN08
	Nut 10 <i>Slot 10</i>	-	-	-	-	1.0	-	-	095AN10
	Nut 12 <i>Slot 12</i>	-	-	-	-	1.0	-	-	095AN12
	Nut 14 <i>Slot 14</i>	-	-	-	-	1.0	-	-	095AN14



Aludruckguss-Kombischarnier 60

Die-cast Aluminum Combi Hinge 60

Beschreibung aushängbar für Flächenelemente und Aluminiumprofile, mit je einem Steckplatz für Zentrierbolzen

Material Flügel: Aluminiumdruckguss
Achse: Edelstahl
Zentrierbolzen (optional): Kunststoff PA, glasfaserverstärkt

Oberfläche alufarbig lackiert

Befestigung vorderseitig mit Senkschrauben M6

Liefereinheit 10 Stück

Description Detachable To hinge panels or aluminum profiles, each with a hole for centering bolts

Material Wings: Die-cast-aluminum
Pin: Stainless steel
Centering bolt (optional): Nylon PA, glass fibre reinforced

Surface Alu color laquered

Fastening From the front, using M6 countersunk screws

Pack Quantity 10 pieces

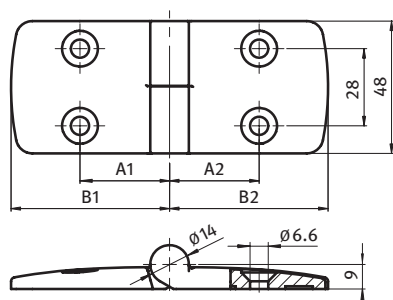

Scharnier Hinge	Bezeichnung Description	A1 [mm]	A2 [mm]	B1 [mm]	B2 [mm]	Gewicht [g] Weight [g]	FMax [N]	FRmax [N]	Teil-Nr. Part #
links left	60/60	32.5	32.5	57.5	57.5	88.0	150	575	095A6060L
	60/25	32.5	15.0	57.5	26.0	72.0	250	410	095A2560L
	60/30	32.5	17.5	57.5	29.5	76.0	280	450	095A3060L
	60/35	32.5	20.0	57.5	36.0	80.0	250	500	095A3560L
	60/40	32.5	22.5	57.5	38.5	78.0	200	550	095A4060L
	60/45	32.5	25.0	57.5	43.5	80.0	200	550	095A4560L
rechts right	60/50	32.5	27.5	57.5	48.5	83.0	175	575	095A5060L
	60/60	32.5	32.5	57.5	57.5	88.0	150	575	095A6060R
	60/25	32.5	15.0	57.5	26.0	72.0	250	410	095A2560R
	60/30	32.5	17.5	57.5	29.5	76.0	280	450	095A3060R
	60/35	32.5	20.0	57.5	36.0	80.0	250	500	095A3560R
	60/40	32.5	22.5	57.5	38.5	78.0	200	550	095A4060R
Zentrierbolzen Centering bolt	Nut 5 Slot 5	-	-	-	-	1.0	-	-	095AN05
	Nut 6 Slot 6	-	-	-	-	1.0	-	-	095AN06
	Nut 8 Slot 8	-	-	-	-	1.0	-	-	095AN08
	Nut 10 Slot 10	-	-	-	-	1.0	-	-	095AN10
	Nut 12 Slot 12	-	-	-	-	1.0	-	-	095AN12
	Nut 14 Slot 14	-	-	-	-	1.0	-	-	095AN14



Aludruckguss-Kombischarnier 60

Die-cast Aluminum Combi Hinge 60

Beschreibung nicht aushängbar
für Flächenelemente und Aluminiumprofile, mit je einem Steckplatz für Zentrierbolzen

Material Flügel: Aluminiumdruckguss
Achse: Edelstahl
Zentrierbolzen (optional): Kunststoff PA, glasfaserverstärkt

Oberfläche alufarbig lackiert

Befestigung vorderseitig mit Senkschrauben M6

Liefereinheit 10 Stück

Description *Non-detachable*
To hinge panels or aluminum profiles, each with a hole for centering bolts

Material *Wings: Die-cast-aluminum*
Pin: Stainless steel
Centering bolt (optional): Nylon PA, glass fibre reinforced

Surface *Alu color laquered*

Fastening *From the front, using M6 countersunk screws*

Pack Quantity *10 pieces*

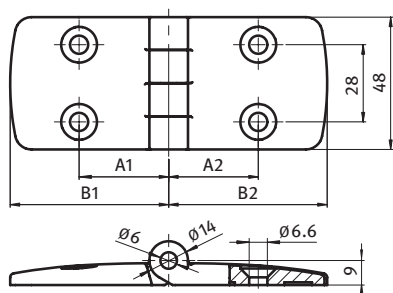

Scharnier Hinge	Bezeichnung Description	A1 [mm]	A2 [mm]	B1 [mm]	B2 [mm]	Gewicht [g] Weight [g]	F _{Amax} [N]	F _{Rmax} [N]	Teil-Nr. Part #
nicht aushängbar <i>Non-detachable</i>	60/60	32.5	32.5	57.5	57.5	89.0	100	400	095A6060F
	60/25	32.5	15.0	57.5	26.0	73.0	215	275	095A2560F
	60/30	32.5	17.5	57.5	29.5	77.0	225	400	095A3060F
	60/35	32.5	20.0	57.5	36.0	81.0	225	325	095A3560F
	60/40	32.5	22.5	57.5	38.5	79.0	250	400	095A4060F
	60/45	32.5	25.0	57.5	43.5	81.0	250	400	095A4560F
	60/50	32.5	27.5	57.5	48.5	84.0	250	400	095A5060F
Zentrierbolzen <i>Centering bolt</i>	Nut 5 <i>Slot 5</i>	-	-	-	-	1.0	-	-	095AN05
	Nut 6 <i>Slot 6</i>	-	-	-	-	1.0	-	-	095AN06
	Nut 8 <i>Slot 8</i>	-	-	-	-	1.0	-	-	095AN08
	Nut 10 <i>Slot 10</i>	-	-	-	-	1.0	-	-	095AN10
	Nut 12 <i>Slot 12</i>	-	-	-	-	1.0	-	-	095AN12
	Nut 14 <i>Slot 14</i>	-	-	-	-	1.0	-	-	095AN14

X-ON Electronics

Largest Supplier of Electrical and Electronic Components

Click to view similar products for [Fath manufacturer](#):

Other Similar products are found below :

[087EPE01911](#) [087EPE02911](#) [087EPE02931](#) [087EPE03911](#) [087EPE03912](#) [087EPE04911](#) [087SPES01911](#) [087SPET01911](#) [091007](#) [091180](#)
[091184](#) [091185](#) [092001](#) [092002](#) [092012](#) [092017](#) [092041S13](#) [092042](#) [092080A](#) [092082](#) [09304701](#) [093082](#) [093091](#) [09309301](#) [093166SW](#)
[093254](#) [093B2001V](#) [093G30AN06](#) [093G40AN](#) [093GA20AN](#) [093GAF20AN](#) [093GF30AN06](#) [093GF40AN](#) [093M1230](#) [093PS0840](#)
[093V4080S](#) [093VL120120](#) [093W201N05](#) [093W203N05](#) [093W301N06](#) [093W301N06S03](#) [093W301N08R](#) [093W303N08S11](#) [093W401N08](#)
[093W401N08S03](#) [093W403N10](#) [093W601S01](#) [093W802N08](#) [093W802N08S02](#) [093WA201](#)