

Selection diagram

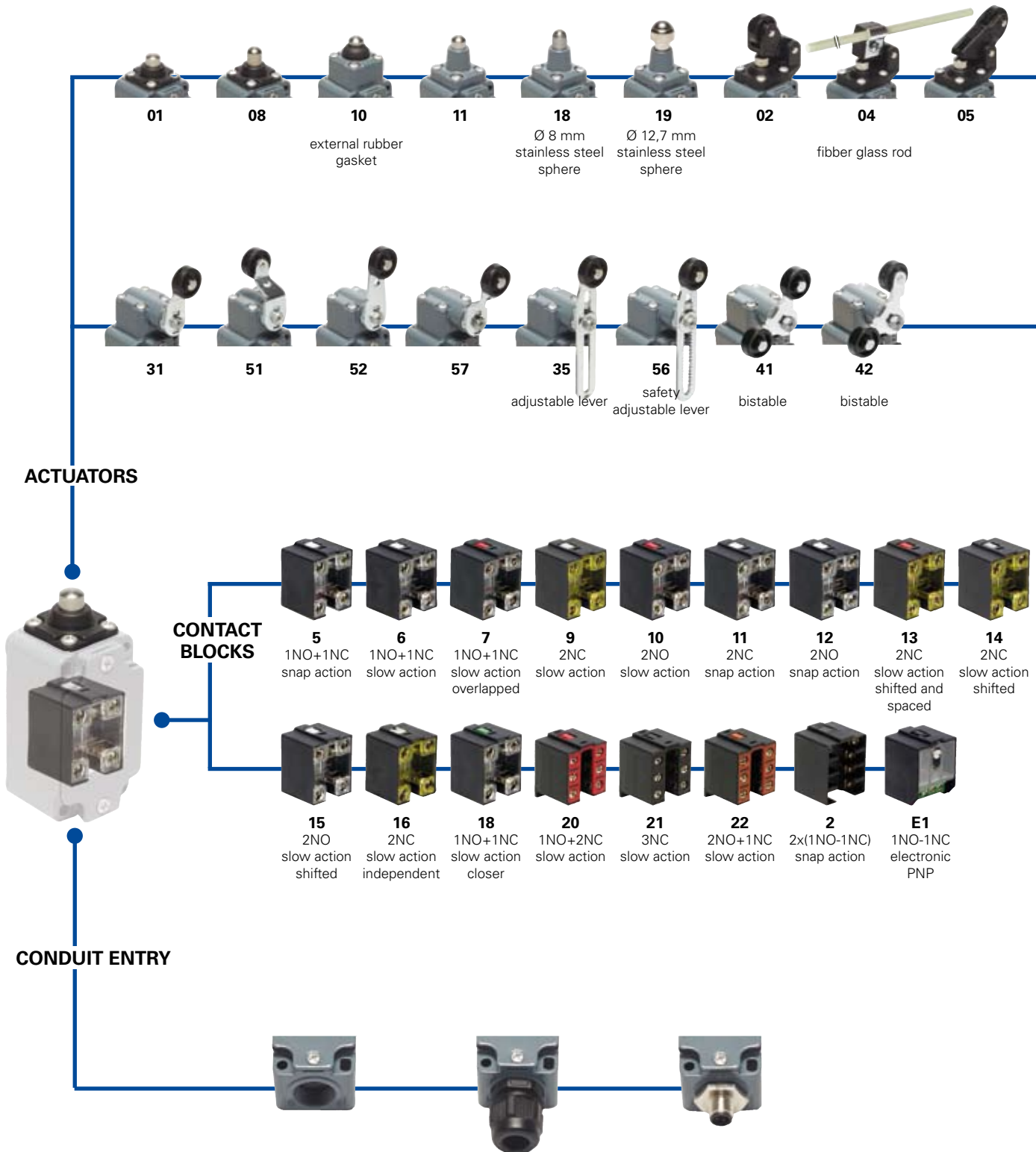

01

08

10

11

18

19

02

04

05

external rubber gasket

Ø 8 mm stainless steel sphere

Ø 12,7 mm stainless steel sphere

fiber glass rod

31

51

52

57

35

56

41

42

adjustable lever

safety adjustable lever

bistable

bistable

ACTUATORS

CONTACT BLOCKS

5

6

7

9

10

11

12

13

14

1NO+1NC snap action

1NO+1NC slow action

1NO+1NC slow action overlapped

2NC slow action

2NO slow action

2NC snap action

2NO snap action

2NC slow action shifted and spaced

2NC slow action shifted

15

16

18

20

21

22

2

E1

2NO slow action shifted

2NC slow action independent

1NO+1NC slow action closer

1NO+2NC slow action

3NC slow action

2NO+1NC slow action

2x(1NO-1NC) snap action

1NO-1NC electronic PNP

CONDUIT ENTRY

Threaded conduit entry

	PG 13,5 (standard)
M2	M20x1,5

With assembled cable gland

PG 13,5	K21	for Ø 6 to Ø 12 mm cables range
	K25	for Ø 3 to Ø 7 mm cables range
M20x1,5	K23	for Ø 6 to Ø 12 mm cables range
	K27	for Ø 3 to Ø 7 mm cables range

With M12 metal connector assembled and wired

K40	8 poles from bottom
K50	5 poles from bottom

- product option
- ➔ accessory sold separately

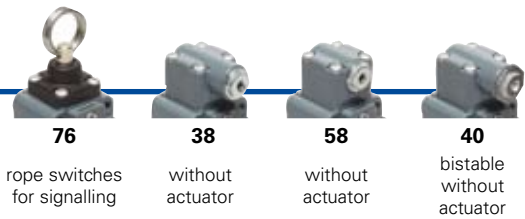
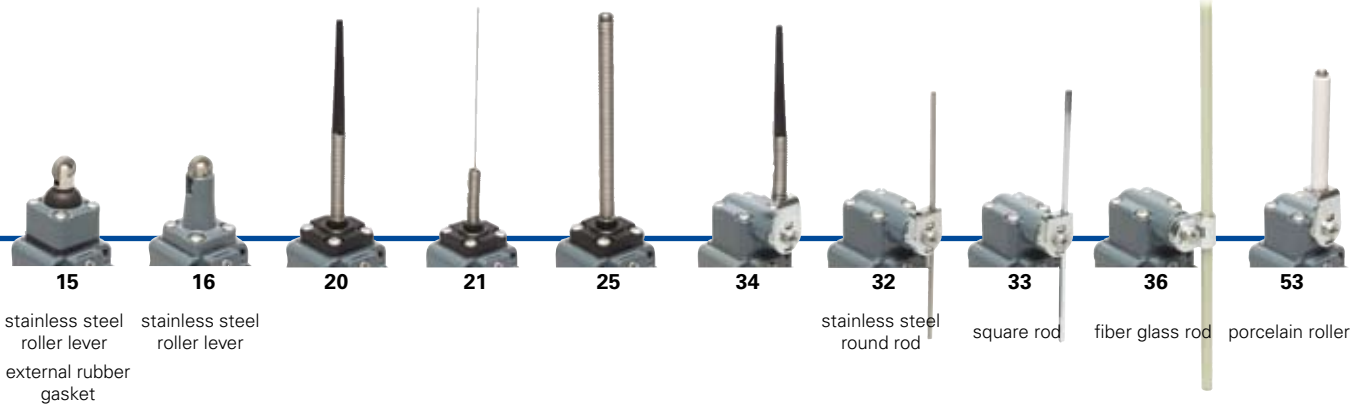

LOOSE ACTUATORS
See page 2/11



Code structure **Attention!** The feasibility of a code number does not mean the effective availability of a product. Please contact our sales office.

article options
FD 502-1GM2K50

Housing	
FD	metal housing, one conduit entry
Contact blocks	
5	1NO+1NC, snap action
6	1NO+1NC, slow action
7	1NO+1NC, slow action overlapped
...
Actuators	
01	short plunger
02	roller lever
05	offset roller lever
...
Suffix	
	no suffix (standard)
1	with Ø 20 mm stainless steel roller for actuators 02, 05, 31, 35, 51, 52, 56, 57, 41, 42
2	with Ø 35 mm polymer roller (see special loose actuators on page 2/12)
3	with Ø 50 mm rubber roller (see special loose actuators on page 2/12)
4	with Ø 50 mm overhanging rubber roller (see special loose actuators on page 2/12)

Preinstalled cable gland or connectors	
	no cable gland or connector (standard)
K21	with assembled cable gland suitable for Ø 6 to Ø 12 mm cables range
...
K50	with 5 poles M12 metal connector
...

For the complete list of all combinations, please contact our technical office.

Threaded conduit entry	
	PG 13,5 (standard)
M2	M20x1,5

Contacts type	
	silver contacts (standard)
G	silver contacts gold plated 1 µm (contact block 2 excluded)



Main data

- Metal housing, one conduit entry
- Protection degree IP67
- 17 contact blocks available
- 28 actuators available
- M12 assembled connector versions
- Silver contacts gold plated versions

Technical data

Housing

Metal housing, coated with baked epoxy powder

One threaded conduit entry

Protection degree: IP67 according to EN 60529

General data

Ambient temperature: from -25°C to +80°C

Version for operation in ambient temperature from -40°C to +80°C on request

Max actuation frequency: 3600 operations cycles¹/hour

Mechanical endurance: 20 million operations cycles¹

Assembling position: any

Driving torque for installation: see pages 7/1-7/10

(1) One operation cycle means two movements, one to close and one to open contacts, as foreseen by EN 60947-5-1 standard.

Cross section of the conductors (flexible copper wire)

Contact blocks 20, 21, 22, 33, 34:	min.	1 x 0,34 mm ²	(1 x AWG 22)
	max.	2 x 1,5 mm ²	(2 x AWG 16)
Contact blocks 5, 6, 7, 9, 10, 11, 12, 13, 14, 15, 16, 18:	min.	1 x 0,5 mm ²	(1 x AWG 20)
	max.	2 x 2,5 mm ²	(2 x AWG 14)
Contact block 2:	min.	1 x 0,5 mm ²	(1 x AWG 20)
	max.	2 x 1,5 mm ²	(2 x AWG 16)

In conformity with standards:

IEC 60947-5-1, EN 60947-5-1, EN 60947-1, EN 50041, IEC 60204-1, EN 60204-1, EN 1088, EN ISO 12100-1, EN ISO 12100-2, IEC 60529, EN 60529, NFC 63-140, VDE 0660-200, VDE 0113.

Approvals:

IEC 60947-5-1, UL 508, GB14048.5-2001.

Markings and quality marks:



Approval IMQ: EG605
 Approval UL: E131787
 Approval CCC: 2007010305230000
 Approval EZU: 1010151

In conformity with requirements requested by:

Low Voltage Directive 2006/95/EC, Machinery Directive 2006/42/EC and Electromagnetic Compatibility 2004/108/EC.

Positive contact opening in conformity with standards:

IEC 60947-5-1, EN 60947-5-1, VDE 0660-206.

Installation for safety applications:

Use only switches marked with the symbol ⊕. The safety circuit must always be connected with the **NC contacts** (normally closed contacts: 11-12, 21-22 or 31-32) as stated in the **standard EN 60947-5-1, encl. K, par. 2**. The switch must be actuated with **at least up to the positive opening travel** shown in the travels diagrams on page 7/4. The switch must be actuated **at least with the positive opening force**, shown in brackets, underneath each article, near the value of the min. force.

⚠ If not expressly indicated in this chapter, for the right installation and the correct utilization of all articles see requirements indicated from page 7/1 to page 7/10.

Electrical data		Utilization categories					
without connector	Thermal current (I _{th}):	10 A	Alternate current: AC15 (50...60 Hz)				
	Rated insulation voltage (U _i):	500 Vac 600 Vdc	U _e (V)	250	400	500	
	Rated impulse withstand voltage (U _{imp}):	400Vac500Vdc(contact blocks 2, 11, 12, 20, 21, 22, 33, 34)	I _e (A)	6	4	1	
		6 kV	Direct current: DC13				
Conditional short circuit current:	1000 A according to EN 60947-5-1	U _e (V)	24	125	250		
	Protection against short circuits:	fuse 10 A 500 V type aM	I _e (A)	6	1,1	0,4	
	Pollution degree:	3					
with 5 poles M12 connector	Thermal current (I _{th}):	4 A	Alternate current: AC15 (50...60 Hz)				
	Rated insulation voltage (U _i):	250 Vac 300 Vdc	U _e (V)	24	120	250	
	Protection against short circuits:	fuse 4 A 500 V type gG	I _e (A)	4	4	4	
	Pollution degree:	3	Direct current: DC13				
U _e (V)	24	125	250				
	I _e (A)	4	1,1	0,4			
				Alternate current: AC15 (50...60 Hz)			
with 8 poles M12 connector	Thermal current (I _{th}):	2 A	U _e (V)	24			
	Rated insulation voltage (U _i):	30 Vac 36 Vdc	I _e (A)	2			
	Protection against short circuits:	fuse 2 A 500 V type gG	Direct current: DC13				
	Pollution degree:	3	U _e (V)	24			
			I _e (A)	2			



Data type approved by IMQ, CCC and EZU

Rated insulation voltage (Ui): 500 Vac
400 Vac (for contact blocks 2, 11, 12, 20, 21, 22, 33, 34)

Thermal current (Ith): 10 A

Protection against short circuits: fuse 10 A 500 V type aM

Rated impulse withstand voltage (U_{imp}): 6 kV
4 kV (for contact blocks 20, 21, 22, 33, 34)

Protection degree: IP67

MV terminals (screw clamps)

Pollution degree 3

Utilization category: AC15

Operation voltage (Ue): 400 Vac (50 Hz)

Operation current (Ie): 3 A

Forms of the contact element: Za, Zb, Za+Za, Y+Y, X+X, Y+Y+X, Y+Y+Y, Y+X+X

Positive opening of contacts on contact block 5, 6, 7, 9, 11, 13, 14, 16, 18, 20, 21, 22, 33, 34

In conformity with standards: EN 60947-1, EN 60947-5-1 + A1:2009, fundamental requirements of the Low Voltage Directive 2006/95/CE.

Please contact our technical service for the list of approved products.

Data type approved by UL

Utilization categories Q300 (69 VA, 125-250 Vdc)
A600 (720 VA, 120-600 Vac)

Data of the housing type 1, 4X "indoor use only", 12, 13

For all contact blocks except 2 and 3 use 60 or 75 °C copper (Cu) conductor and wire size No. 12-14 AWG. Terminal tightening torque of 7,1 lb in (0,8 Nm).

For contact blocks 2 and 3 use 60 or 75 °C copper (Cu) conductor and wire size No. 14 AWG. Terminal tightening torque of 12 lb in (1,4 Nm).

In conformity with standard: UL 508

Please contact our technical service for the list of approved products.

Adjustable levers

In switches with revolving lever it is possible to adjust the lever with 10° steps for the whole 360° range. The positive movement transmission is always guaranteed thanks to the particular geometrical coupling between the lever and the revolving shaft as prescribed for safety applications by the German standard BG-GS-ET-15.



Overturning levers

It's possible to fasten the lever on switches on straight or reverse side, maintaining the positive coupling. In this way it is possible to obtain two different work plans of the lever.



Rotating heads

In all switches, it is possible to rotate the head in 90° steps.



Working operation of contact block 16 with independent contacts

The contact block 16 has two NC contacts, both with positive opening activated independently according to the lever turning direction.

Lever turned to left

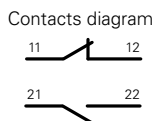

Lever not turned

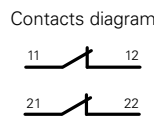

Lever turned to right

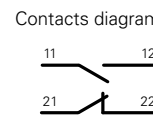

Unidirectional heads

In the switches with revolving lever, it is possible to select the directional operation by removing the four screws of the head and revolving the internal piston (contact block 16 excluded).

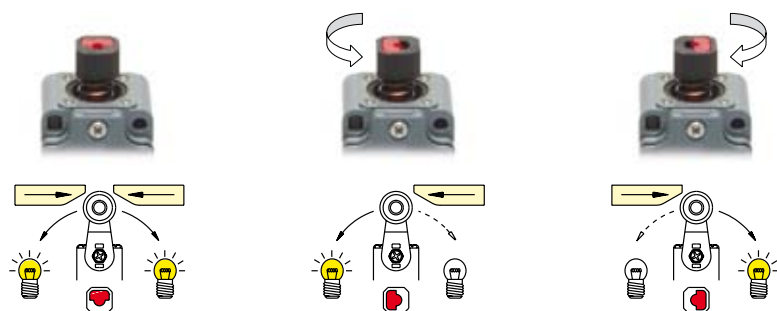
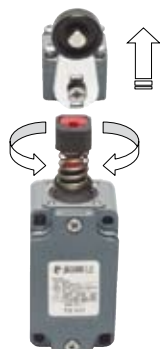

Contacts type:

- R** = snap action
- L** = slow action
- LO** = slow action overlapped
- LS** = slow action shifted
- LV** = slow action shifted and spaced
- LI** = slow action independent
- LA** = slow action closer
- ⏏** = electronic PNP

Contact blocks

	With stainless steel roller on request	With stainless steel roller on request	With stainless steel roller on request	With stainless steel roller on request
5 R	FD 501 → 1NO+1NC	FD 502 → 1NO+1NC	FD 504 1NO+1NC	FD 505 → 1NO+1NC
6 L	FD 601 → 1NO+1NC	FD 602 → 1NO+1NC	FD 604 1NO+1NC	FD 605 → 1NO+1NC
7 LO	FD 701 → 1NO+1NC	FD 702 → 1NO+1NC	FD 704 1NO+1NC	FD 705 → 1NO+1NC
9 L	FD 901 → 2NC	FD 902 → 2NC	FD 904 2NC	FD 905 → 2NC
10 L	FD 1001 2NO	FD 1002 2NO	FD 1004 2NO	FD 1005 2NO
11 R	FD 1101 → 2NC	FD 1102 → 2NC	FD 1104 2NC	FD 1105 → 2NC
12 R	FD 1201 2NO	FD 1202 2NO	FD 1204 2NO	FD 1205 2NO
13 LV	FD 1301 → 2NC	FD 1302 → 2NC	FD 1304 2NC	FD 1305 → 2NC
14 LS	FD 1401 → 2NC	FD 1402 → 2NC	FD 1404 2NC	FD 1405 → 2NC
15 LS	FD 1501 2NO	FD 1502 2NO	FD 1504 2NO	FD 1505 2NO
18 LA	FD 1801 → 1NO+1NC	FD 1802 → 1NO+1NC	FD 1804 1NO+1NC	FD 1805 → 1NO+1NC
20 L	FD 2001 → 1NO+2NC	FD 2002 → 1NO+2NC	FD 2004 1NO+2NC	FD 2005 → 1NO+2NC
21 L	FD 2101 → 3NC	FD 2102 → 3NC	FD 2104 3NC	FD 2105 → 3NC
22 L	FD 2201 → 2NO+1NC	FD 2202 → 2NO+1NC	FD 2204 2NO+1NC	FD 2205 → 2NO+1NC
2 R	FD 201 2x(1NO-1NC)	FD 202 2x(1NO-1NC)	FD 204 2x(1NO-1NC)	FD 205 2x(1NO-1NC)
E1 ⏏	FD E101 1NO-1NC	FD E102 1NO-1NC	FD E104 1NO-1NC	FD E105 1NO-1NC
Max speed	page 7/3 - type 4	page 7/3 - type 3	0,5 m/s	page 7/3 - type 3
Min. force	8 N (25 N →)	6 N (25 N →)	0,17 Nm	6 N (25 N →)
Travel diagrams	page 7/4 - group 1	page 7/4 - group 2	page 7/4 - group 1	page 7/4 - group 2

	With external rubber gasket	With external rubber gasket	With external rubber gasket	With external rubber gasket
5 R	FD 508 → 1NO+1NC	FD 510 → 1NO+1NC	FD 511 → 1NO+1NC	FD 515 → 1NO+1NC
6 L	FD 608 → 1NO+1NC	FD 610 → 1NO+1NC	FD 611 → 1NO+1NC	FD 615 → 1NO+1NC
7 LO	FD 708 → 1NO+1NC	FD 710 → 1NO+1NC	FD 711 → 1NO+1NC	FD 715 → 1NO+1NC
9 L	FD 908 → 2NC	FD 910 → 2NC	FD 911 → 2NC	FD 915 → 2NC
10 L	FD 1008 2NO	FD 1010 2NO	FD 1011 2NO	FD 1015 2NO
11 R	FD 1108 → 2NC	FD 1110 → 2NC	FD 1111 → 2NC	FD 1115 → 2NC
12 R	FD 1208 2NO	FD 1210 2NO	FD 1211 2NO	FD 1215 2NO
13 LV	FD 1308 → 2NC	FD 1310 → 2NC	FD 1311 → 2NC	FD 1315 → 2NC
14 LS	FD 1408 → 2NC	FD 1410 → 2NC	FD 1411 → 2NC	FD 1415 → 2NC
15 LS	FD 1508 2NO	FD 1510 2NO	FD 1511 2NO	FD 1515 2NO
18 LA	FD 1808 → 1NO+1NC	FD 1810 → 1NO+1NC	FD 1811 → 1NO+1NC	FD 1815 → 1S+1Ö
20 L	FD 2008 → 1NO+2NC	FD 2010 → 1NO+2NC	FD 2011 → 1NO+2NC	FD 2015 → 1NO+2NC
21 L	FD 2108 → 3NC	FD 2110 → 3NC	FD 2111 → 3NC	FD 2115 → 3NC
22 L	FD 2208 → 2NO+1NC	FD 2210 → 2NO+1NC	FD 2211 → 2NO+1NC	FD 2215 → 2NO+1NC
2 R	FD 208 2x(1NO-1NC)	FD 210 2x(1NO-1NC)	FD 211 2x(1NO-1NC)	FD 215 2x(1NO-1NC)
E1 ⏏	FD E108 1NO-1NC	FD E110 1NO-1NC	FD E111 1NO-1NC	FD E115 1NO-1NC
Max speed	page 7/3 - type 4	page 7/3 - type 4	page 7/3 - type 4	page 7/3 - type 2
Min. force	8 N (25 N →)	11 N (25 N →)	8 N (25 N →)	11 N (25 N →)
Travel diagrams	page 7/4 - group 1	page 7/4 - group 1	page 7/4 - group 1	page 7/4 - group 1

Accessories See page 6/1

All measures in the drawings are in mm



Contacts type:

- R** = snap action
- L** = slow action
- LO** = slow action overlapped
- LS** = slow action shifted
- LV** = slow action shifted and spaced
- LI** = slow action independent
- LA** = slow action closer
- ⏏** = electronic PNP

Contact blocks

		Ø 8 mm stainless steel sphere	Ø 12,7 mm stainless steel sphere	With external rubber gasket
5 R	FD 516 → 1NO+1NC	FD 518 → 1NO+1NC	FD 519 → 1NO+1NC	FD 520 1NO+1NC
6 L	FD 616 → 1NO+1NC	FD 618 → 1NO+1NC	FD 619 → 1NO+1NC	
7 LO	FD 716 → 1NO+1NC	FD 718 → 1NO+1NC	FD 719 → 1NO+1NC	
9 L	FD 916 → 2NC	FD 918 → 2NC	FD 919 → 2NC	
10 L	FD 1016 2NO	FD 1018 2NO	FD 1019 2NO	FD 1020 2NO
11 R	FD 1116 → 2NC	FD 1118 → 2NC	FD 1119 → 2NC	
12 R	FD 1216 2NO	FD 1218 2NO	FD 1219 2NO	
13 LV	FD 1316 → 2NC	FD 1318 → 2NC	FD 1319 → 2NC	
14 LS	FD 1416 → 2NC	FD 1418 → 2NC	FD 1419 → 2NC	
15 LS	FD 1516 2NO	FD 1518 2NO	FD 1519 2NO	
18 LA	FD 1816 → 1S+1Ö	FD 1818 → 1S+1Ö	FD 1819 → 1S+1Ö	FD 1820 1NO+1NC
20 L	FD 2016 → 1NO+2NC	FD 2018 → 1NO+2NC	FD 2019 → 1NO+2NC	FD 2020 1NO+2NC
21 L	FD 2116 → 3NC	FD 2118 → 3NC	FD 2119 → 3NC	FD 2120 3NC
22 L	FD 2216 → 2NO+1NC	FD 2218 → 2NO+1NC	FD 2219 → 2NO+1NC	FD 2220 2NO+1NC
2 R	FD 216 2x(1NO-1NC)	FD 218 2x(1NO-1NC)	FD 219 2x(1NO-1NC)	FD 220 2x(1NO-1NC)
E1 ⏏	FD E116 1NO-1NC	FD E118 1NO-1NC	FD E119 1NO-1NC	FD E120 1NO-1NC
Max speed	page 7/3 - type 2	page 7/3 - type 4	page 7/3 - type 4	1 m/s
Min. force	8 N (25 N →)	8 N (25 N →)	8 N (25 N →)	0,09 Nm
Travel diagrams	page 7/4 - group 1	page 7/4 - group 1	page 7/4 - group 1	page 7/4 - group 3

	With external rubber gasket	With external rubber gasket	Other rollers available. See page 2/12	Ø 3 mm stainless steel round rod
5 R	FD 521 1NO+1NC	FD 525 1NO+1NC	FD 531 → 1NO+1NC	FD 532 1NO+1NC
6 L			FD 631 → 1NO+1NC	FD 632 1NO+1NC
7 LO			FD 731 → 1NO+1NC	FD 732 1NO+1NC
9 L			FD 931 → 2NC	FD 932 2NC
10 L	FD 1021 2NO	FD 1025 2NO	FD 1031 2NO	FD 1032 2NO
11 R			FD 1131 → 2NC	FD 1132 2NC
12 R			FD 1231 2NO	FD 1232 2NO
13 LV			FD 1331 → 2NC	FD 1332 2NC
14 LS			FD 1431 → 2NC	FD 1432 2NC
15 LS			FD 1531 2NO	FD 1532 2NO
16 LI			FD 1631 → 2NC	FD 1632 2NC
18 LA	FD 1821 1NO+1NC	FD 1825 1NO+1NC	FD 1831 → 1NO+1NC	FD 1832 1S+1Ö
20 L	FD 2021 1NO+2NC	FD 2025 1NO+2NC	FD 2031 → 1NO+2NC	FD 2032 1NO+2NC
21 L	FD 2121 3NC	FD 2125 3NC	FD 2131 → 3NC	FD 2132 3NC
22 L	FD 2221 2NO+1NC	FD 2225 2NO+1NC	FD 2231 → 2NO+1NC	FD 2232 2NO+1NC
2 R	FD 221 2x(1NO-1NC)	FD 225 2x(1NO-1NC)	FD 231 2x(1NO-1NC)	FD 232 2x(1NO-1NC)
E1 ⏏	FD E121 1NO-1NC	FD E125 1NO-1NC	FD E131 1NO-1NC	FD E132 1NO-1NC
Max speed	1 m/s	1 m/s	page 7/3 - type 1	1,5 m/s
Min. force	0,08 Nm	0,14 Nm	0,1 Nm (0,25 Nm →)	0,1 Nm
Travel diagrams	page 7/4 - group 3	page 7/4 - group 3	page 7/4 - group 4	page 7/4 - group 4

Items with code on the green background are available in stock

Contacts type:

- R** = snap action
- L** = slow action
- LO** = slow action overlapped
- LS** = slow action shifted
- LV** = slow action shifted and spaced
- LI** = slow action independent
- LA** = slow action closer
- PNP** = electronic PNP

Contact blocks

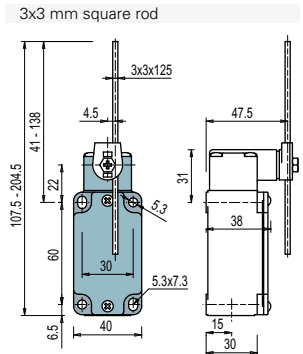
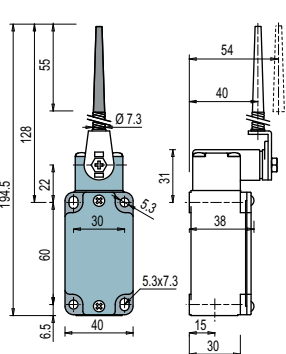
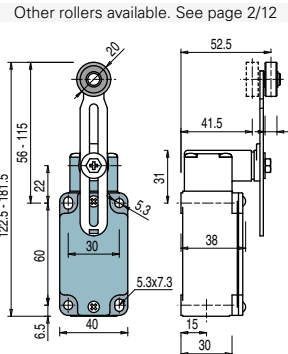
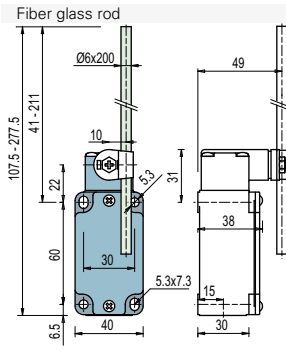
				
5	R FD 533 1NO+1NC	FD 534 1NO+1NC	FD 535 ⊕ (1) 1NO+1NC	FD 536 1NO+1NC
6	L FD 633 1NO+1NC	FD 634 1NO+1NC	FD 635 ⊕ (1) 1NO+1NC	FD 636 1NO+1NC
7	LO FD 733 1NO+1NC	FD 734 1NO+1NC	FD 735 ⊕ (1) 1NO+1NC	FD 736 1NO+1NC
9	L FD 933 2NC	FD 934 2NC	FD 935 ⊕ (1) 2NC	FD 936 2NC
10	L FD 1033 2NO	FD 1034 2NO	FD 1035 2NO	FD 1036 2NO
11	R FD 1133 2NC	FD 1134 2NC	FD 1135 ⊕ (1) 2NC	FD 1136 2NC
12	R FD 1233 2NO	FD 1234 2NO	FD 1235 2NO	FD 1236 2NO
13	LV FD 1333 2NC	FD 1334 2NC	FD 1335 ⊕ (1) 2NC	FD 1336 2NC
14	LS FD 1433 2NC	FD 1434 2NC	FD 1435 ⊕ (1) 2NC	FD 1436 2NC
15	LS FD 1533 2NO	FD 1534 2NO	FD 1535 2NO	FD 1536 2NO
16	LI FD 1633 2NC	FD 1634 2NC	FD 1635 ⊕ (1) 2NC	FD 1636 2NC
18	LA FD 1833 1S+1Ö	FD 1834 1S+1Ö	FD 1835 ⊕ (1) 1S+1Ö	FD 1836 1S+1Ö
20	L FD 2033 1NO+2NC	FD 2034 1NO+2NC	FD 2035 ⊕ (1) 1NO+2NC	FD 2036 1NO+2NC
21	L FD 2133 3NC	FD 2134 3NC	FD 2135 ⊕ (1) 3NC	FD 2136 3NC
22	L FD 2233 2NO+1NC	FD 2234 2NO+1NC	FD 2235 ⊕ (1) 2NO+1NC	FD 2236 2NO+1NC
2	R FD 233 2x(1NO-1NC)	FD 234 2x(1NO-1NC)	FD 235 2x(1NO-1NC)	FD 236 2x(1NO-1NC)
E1	PNP FD E133 1NO-1NC	FD E134 1NO-1NC	FD E135 1NO-1NC	FD E136 1NO-1NC
Max speed	1,5 m/s	1 m/s	page 7/3 - type 1	1,5 m/s
Min. force	0,1 Nm	0,1 Nm	0,1 Nm (0,25 Nm ⊕)	0,1 Nm
Travel diagrams	page 7/4 - group 4	page 7/4 - group 4	page 7/4 - group 4	page 7/4 - group 4

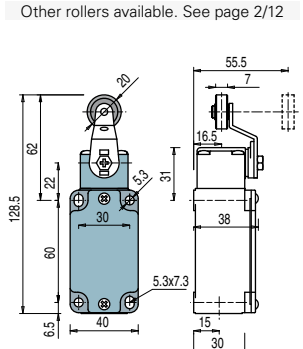
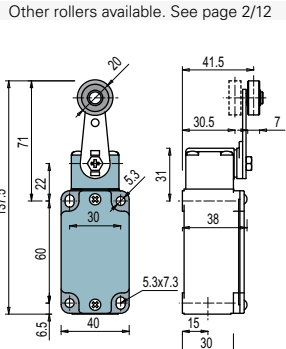
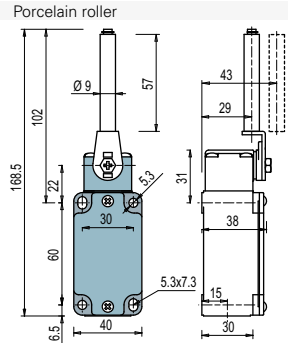
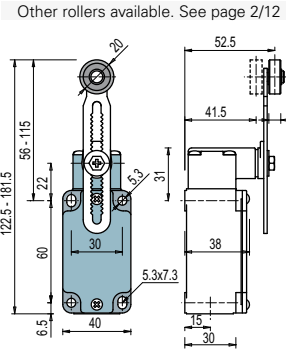
				
5	R FD 551 ⊕ 1NO+1NC	FD 552 ⊕ 1NO+1NC	FD 553-E11V9 ⊕ 1NO+1NC	FD 556 ⊕ 1NO+1NC
6	L FD 651 ⊕ 1NO+1NC	FD 652 ⊕ 1NO+1NC	FD 653-E11V9 ⊕ 1NO+1NC	FD 656 ⊕ 1NO+1NC
7	LO FD 751 ⊕ 1NO+1NC	FD 752 ⊕ 1NO+1NC	FD 753-E11V9 ⊕ 1NO+1NC	FD 756 ⊕ 1NO+1NC
9	L FD 951 ⊕ 2NC	FD 952 ⊕ 2NC	FD 953-E11V9 ⊕ 2NC	FD 956 ⊕ 2NC
10	L FD 1051 2NO	FD 1052 2NO	FD 1053-E11V9 2NO	FD 1056 2NO
11	R FD 1151 ⊕ 2NC	FD 1152 ⊕ 2NC	FD 1253-E11V9 2NO	FD 1156 ⊕ 2NC
12	R FD 1251 2NO	FD 1252 2NO	FD 1353-E11V9 ⊕ 2NC	FD 1256 2NO
13	LV FD 1351 ⊕ 2NC	FD 1352 ⊕ 2NC	FD 1453-E11V9 ⊕ 2NC	FD 1356 ⊕ 2NC
14	LS FD 1451 ⊕ 2NC	FD 1452 ⊕ 2NC	FD 1553-E11V9 2NO	FD 1456 ⊕ 2NC
15	LS FD 1551 2NO	FD 1552 2NO	FD 1656 ⊕ 2NC	FD 1556 2NO
16	LI			
18	LA FD 1851 ⊕ 1NO+1NC	FD 1852 ⊕ 1S+1Ö	FD 1853-E11V9 ⊕ 1S+1Ö	FD 1856 ⊕ 1S+1Ö
20	L FD 2051 ⊕ 1NO+2NC	FD 2052 ⊕ 1NO+2NC	FD 2053-E11V9 ⊕ 1NO+2NC	FD 2056 ⊕ 1NO+2NC
21	L FD 2151 ⊕ 3NC	FD 2152 ⊕ 3NC	FD 2153-E11V9 ⊕ 3NC	FD 2156 ⊕ 3NC
22	L FD 2251 ⊕ 2NO+1NC	FD 2252 ⊕ 2NO+1NC	FD 2253-E11V9 ⊕ 2NO+1NC	FD 2256 ⊕ 2NO+1NC
2	R FD 251 2x(1NO-1NC)	FD 252 2x(1NO-1NC)	FD 253-E11 2x(1NO-1NC)	FD 256 2x(1NO-1NC)
E1	PNP FD E151 1NO-1NC	FD E152 1NO-1NC	FD E153-E11V9 1NO-1NC	FD E156 1NO-1NC
Max speed	page 7/3 - type 1	page 7/3 - type 1	0,5 m/s	page 7/3 - type 1
Min. force	0,06 Nm (0,25 Nm ⊕)	0,06 Nm (0,25 Nm ⊕)	0,03 Nm (0,25 Nm ⊕)	0,1 Nm (0,25 Nm ⊕)
Travel diagrams	page 7/4 - group 4	page 7/4 - group 4	page 7/4 - group 5	page 7/4 - group 4

Accessories See page 6/1

(1) Positive opening only with lever adjusted on the max. See page 2/11.



Contacts type:

- R** = snap action
- L** = slow action
- LO** = slow action overlapped
- LS** = slow action shifted
- LV** = slow action shifted and spaced
- LI** = slow action independent
- LA** = slow action closer
- ⏏** = electronic PNP

Contact blocks

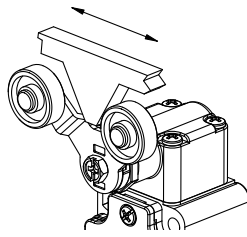
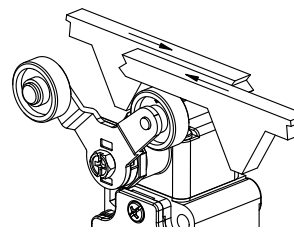
	Other rollers available. See page 2/12	With stainless steel rollers on request	With stainless steel rollers on request	Rope switches for signalling
5	R FD 557 1NO+1NC	FD 541 1NO+1NC	FD 542 1NO+1NC	FD 576 1NO+1NC
6	L FD 657 1NO+1NC	Bistable switch with single track lyra lever	Bistable switch with double track lyra lever	FD 676 1NO+1NC
7	LO FD 757 1NO+1NC			FD 776 1NO+1NC
9	L FD 957 2NC	 <p>0 45° 65° 80° 90° 25° S</p> <p>S = mechanical snap point positive opening with 21-22 contact only</p>	 <p>0 45° 65° 80° 90° 25° S</p> <p>S = mechanical snap point positive opening with 21-22 contact only</p>	FD 976 2NO
10	L FD 1057 2NO			FD 1076 2NC
11	R FD 1157 2NC			FD 1176 2NO
12	R FD 1257 2NO			FD 1276 2NC
13	LV FD 1357 2NC			FD 1376 2NO
14	LS FD 1457 2NC			FD 1476 2NO
15	LS FD 1557 2NO			FD 1576 2NC
16	LI FD 1657 2NC			FD 1876 1NO+1NC
18	LA FD 1857 1S+1Ö			FD 2076 2NO+1NC
20	L FD 2057 1NO+2NC			FD 2176 3NC
21	L FD 2157 3NC	FD 2276 1NO+2NC		
22	L FD 2257 2NO+1NC	FD 276 2x(1NO-1NC)		
2	R FD 257 2x(1NO-1NC)			
E1	⏏ FD E157 1NO-1NC			
Max speed	page 7/3 - type 1	0,5 m/s with 30° cam	0,5 m/s with 30° cam	0,5 m/s
Min. force	0,1 Nm (0,25 Nm ⊕)	0,21 Nm	0,21 Nm	initial 20 N - final 40 N
Travel diagrams	page 7/4 - group 4			page 7/4 - group 6

Items with code on the **green** background are available in stock

Position switches with revolving lever without actuator

Contacts type:

- R** = snap action
- L** = slow action
- LO** = slow action overlapped
- LS** = slow action shifted
- LV** = slow action shifted and spaced
- LI** = slow action independent
- LA** = slow action closer
- ⏏** = electronic PNP

Regular head

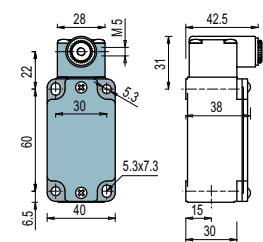

Compact head

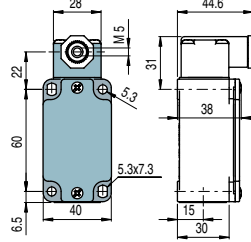
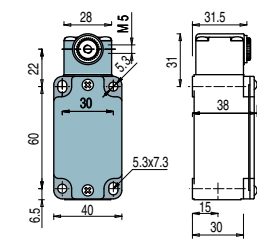

IMPORTANT

For safety applications: join only switches and actuators marked with symbol For more information about safety applications see page 7/1.

Contact blocks

5	R	FD 538		1NO+1NC	FD 558		1NO+1NC	FD 540 1NO+1NC Bistable switch S = mechanical snap point positive opening with 21-22 contact only
6	L	FD 638		1NO+1NC	FD 658		1NO+1NC	
7	LO	FD 738		1NO+1NC	FD 758		1NO+1NC	
9	L	FD 938		2NC	FD 958		2NC	
10	L	FD 1038		2NO	FD 1058		2NO	
11	R	FD 1138		2NC	FD 1158		2NC	
12	R	FD 1238		2NO	FD 1258		2NO	
13	LV	FD 1338		2NC	FD 1358		2NC	
14	LS	FD 1438		2NC	FD 1458		2NC	
15	LS	FD 1538		2NO	FD 1558		2NO	
16	LI	FD 1638		2NC				
18	LA	FD 1838		1NO+1NC	FD 1858		1NO+1NC	
20	L	FD 2038		1NO+2NC	FD 2058		1NO+2NC	
21	L	FD 2138		3NC	FD 2158		3NC	
22	L	FD 2238		2NO+1NC	FD 2258		2NO+1NC	
2	R	FD 238		2x(1NO-1NC)	FD 258		2x(1NO-1NC)	
E1	⏏	FD E138		1NO-1NC	FD E158		1NO-1NC	
Min. force		0,1 Nm (0,25 Nm)		0,06 Nm (0,25 Nm)		0,5 m/s with 30° cam		
Travel diagrams		page 7/4 - group 4		page 7/4 - group 4		0,21 Nm		

Loose actuators

IMPORTANT: These loose actuators can be used with items of series FD, FP, FL, FC only.

Polymer roller Ø 20 mm	Adjustable round rod Ø 3x125 mm	Adjustable square rod 3x3x125 mm	Flexible rod actuator	Adjustable actuator with polymer roller	Adjustable fiber glass rod	
VF L31	VF L32 ⁽³⁾	VF L33 ⁽³⁾	VF L34	VF L35 ^{(1) (3)}	VF L36 ⁽³⁾	
Single track lyra actuator	Double tracks lyra actuator	Polymer roller Ø 20 mm	Polymer roller Ø 20 mm	Porcelain roller	Adjustable safety actua- tor with polymer roller	Polymer roller Ø 20 mm
VF L41	VF L42	VF L51	VF L52	VF L53 ⁽²⁾	VF L56 ⁽³⁾	VF L57

- Only orders for multiple quantities of the packs are accepted.

⁽¹⁾ Actuator VF L35 suits to safety applications only if adjusted to its max length, as you can see in figure beside. If you need an adjustable lever for safety applications, use the adjustable safety lever VF L56.

⁽²⁾ The position switch obtained by assembling the switch FD •58 (e.g. FD 558, FD 658) with the actuator VF L53 will not present the same travel diagrams and actuating forces as the position switch FD •53-E11V9 (e.g. FD 553-E11V9, FD 653-E11V9...).

⁽³⁾ If it is installed with switch FD •58 (e.g. FD 558, FD 658...), the actuator can mechanically interfere with the housing of the switch. The interference could happen or not according to the actuator and the head fixing position.

⁽⁴⁾ The actuator cannot be oriented to inside direction because it will mechanically interfere with the switch head.

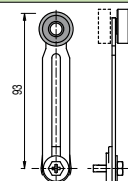

Accessories See page 6/1

Items with code on the **green** background are available in stock



Special loose actuators

IMPORTANT: These loose actuators can be used with items of series FD, FP, FL, FC only.

Ø 20 mm stainless steel rollers

VF L31-1 (1)	VF L35-1 (1) (3)	VF L51-1 (1)	VF L52-1 (1)	VF L56-1 (3)	VF L57-1 (1)

Ø 35 mm polymer rollers

VF L31-2 (4)	VF L35-2 (1) (3)	VF L51-2 (4)	VF L52-2 (1)	VF L56-2 (3)	VF L57-2 (1)

Ø 40 mm rubber rollers

VF L31-R5 (4)	VF L35-R5 (1) (3)	VF L51-R5 (4)	VF L52-R5 (1)	VF L56-R5 (3)	VF L57-R5 (4)

Ø 50 mm rubber rollers

VF L31-3 (4)	VF L35-3 (1) (3)	VF L51-3 (4)	VF L52-3 (4)	VF L56-3 (3)	VF L57-3 (4)

Ø 50 mm overhanging rubber rollers

VF L35-4 (1) (3)	VF L56-4 (3)

X-ON Electronics

Largest Supplier of Electrical and Electronic Components

Click to view similar products for [Limit Switches](#) category:

Click to view products by [Pizzato](#) manufacturer:

Other Similar products are found below :

[6LS2-4PG](#) [5ML1-E1](#) [5ML31](#) [LZG1](#) [LZL1-6C](#) [622EN114-R](#) [622EN18-6](#) [622EN224-6B](#) [622EN230](#) [622EN237-R](#) [622EN69-3](#) [622EN85-RB](#)
[MA-10019](#) [6PA109](#) [7LS51](#) [83547001](#) [83725002](#) [83830001](#) [83840001](#) [83840701](#) [83841001](#) [83870104](#) [83881140](#) [8AS42](#) [8LS10](#) [8LS125-](#)
[4PG](#) [8LS152-4PGN20](#) [914CE16-3A](#) [914CE3-3L1](#) [915PA10](#) [91MCE16-P2O](#) [924CE16-Y3](#) [924CE1-S6](#) [924CE1-T25A](#) [924CE1-T3](#) [924CE1-](#)
[T9A](#) [924CE2-T9](#) [924CE31-Y20-X5](#) [924CE31-Y3L1](#) [GL-10054](#) [GL-85710](#) [GL-85714](#) [GLAB26J2B](#) [GLDB03C-6](#) [GLZ324](#) [PS21R-](#)
[NT11N7-YK0](#) [D4A-1106N](#) [D4A1201N](#) [D4A-3E02N](#) [D4A-4510N](#)