

Smart motor driver with embedded Hall sensor

**Features**

- Motor driver with high sensitivity Hall-effect sensor
- H-Bridge MOS driver
- Lock-shutdown protection & auto-restart function
- “Soft-switch” phase-switching technique to reduce vibration and acoustic noise
- Thermal shutdown protection(TSD)
- Available in SIP-4L package
- For 5V and 12V DC motor / FAN systems



**General Description**

FD1257AH is a single-phase full wave motor driver with embedded Hall-effect sensor IC. It integrates a H-bridge MOS driver, a high sensitivity hall-effect sensor, an event timer for rotor locked in SIP-4L package, which make the motors' PCBs(printed circuit boards) design easy and fabricate the high efficiency DC motors or FANs as simply as possible.

For safety, Lock-shutdown function would turn the IC's internal drivers off avoiding over-heat when the rotor is locked, and IC will try to re-start the rotor's torque after the time of these drivers' shutdown.

Thermal-shutdown protection (TSD) ensures the internal drivers of IC are operating under a safe operating temperature range.

All the protection mechanisms mentioned above combine to provide a complete protecting scenario in the motor system and avoid any possible damages and guarantee under a correct and safe operation.

**Block Diagram**

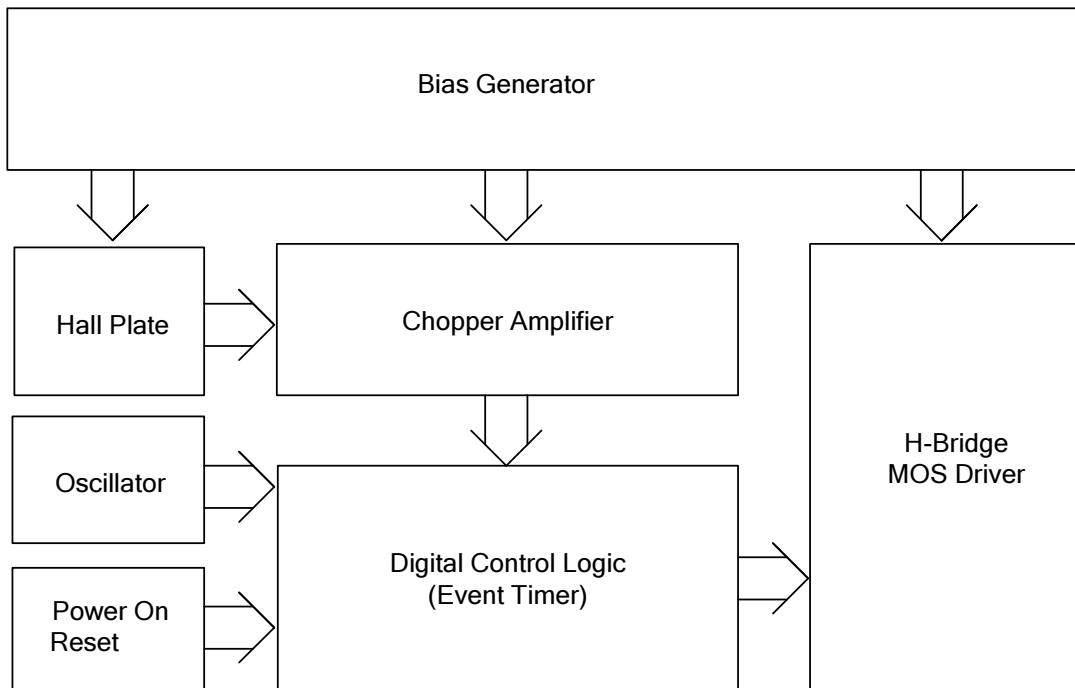

**Figure.1**

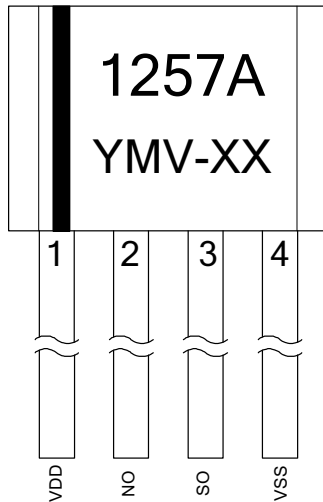
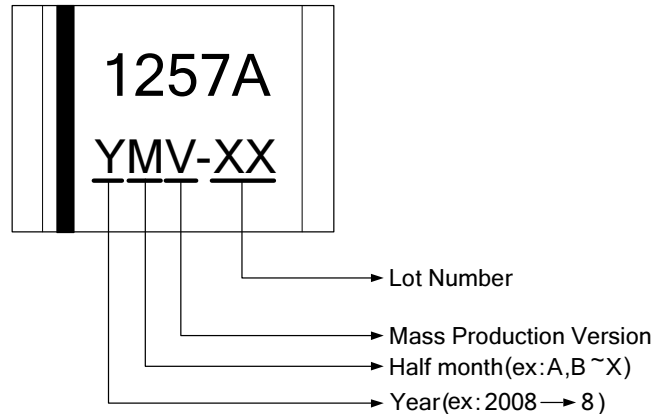
**Pin Connection**

**Figure.2**
**Marking Distinguish**

**Figure.3**
**Pin Descriptions**

Name	I/O	FD1257AH	Description
VDD	P	1	Positive Power Supply
NO	O	2	Driver Output 1
SO	O	3	Driver Output 2
VSS	G	4	Ground

Legend: I=input, O=output, I/O=input/output, P=power supply, G=ground

**Functional Descriptions**

Refer to the block diagram (Figure.1), FD1257AH is composed of the following building blocks:

- Bias generator

The bias generator provides precise, temperature- and process-insensitive bias references for the analog blocks. These references guarantee proper operation of the IC under all conditions specified in this specification.

- Oscillator

The built-in oscillator provides the clock signal for the digital control logic.

- Power On Reset

Used to detect the power-up ramp and reset the digital circuits to achieve correct operation as soon as the power is ready.

- Chopper Amplifier

To achieve a higher magnetic sensitivity the chopper amplifier structure is adopted in this design. Use of this structure dynamically removes both the offset and flicker noise at the same time.

- Digital Control Logic

- Hall sensor part – generates magnetic pole signals from the Hall-effect sensor.
- Driver part – generates switching signals to the H-Bridge MOS driver.
- Timer part – generates an interval of time when rotor locked event is occurred.

**Absolute Maximum Ratings**

Parameter	Symbol	Conditions	Values			Unit
			min.	Typ.	max.	
Operating Temperature	T <sub>OP</sub>	-	-40		85	°C
Storage Temperature	T <sub>ST</sub>	-	-55		150	°C
DC Supply Voltage	V <sub>DD</sub>	V <sub>SS</sub> < V <sub>DD</sub>			18	V
Output Voltage (NO, SO)	V <sub>OUT</sub>	V <sub>DD</sub> = 2.5V ~ 15V			V <sub>DD</sub> + 0.3V	V
Supply Current	I <sub>DD</sub>	-			6	mA
Continuous Current	I <sub>O(CONT)</sub>	T <sub>a</sub> = 25°C			450	mA
Hold Current	I <sub>O(HOLD)</sub>	T <sub>a</sub> = 25°C			1000	mA
Peak Current	I <sub>O(PEAK)</sub>	<100μs, T <sub>a</sub> = 25°C			1200	mA
Junction temperature	T <sub>J</sub>				180	°C
Power Dissipation	P <sub>D</sub>	SIP-4L			1350	mW
Thermal Resistance	θ <sub>JC</sub>	SIP-4L		55		°C/W
Thermal Resistance	θ <sub>JA</sub>	SIP-4L		92.6		°C/W
Magnetic Flux Density	B				Unlimited	Gauss
IR-Reflow Lead Temperature	T <sub>P</sub>	10sec			260	°C

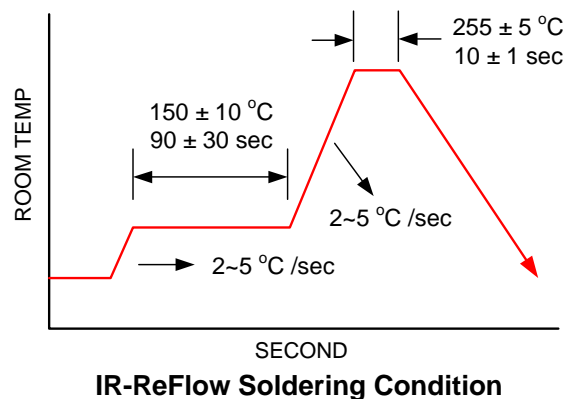
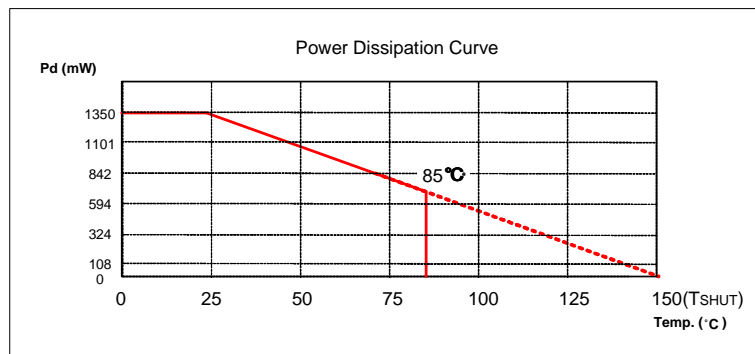

**Recommended Operating Conditions**

Parameter	Symbol	Conditions	Values			Unit
			min.	typ.	max.	
Supply Voltage	$V_{DD}$	-	2.5		17	V
Operating Temperature Range	$T_a$	-	-40		85	°C

**Electrical Characteristics  $T_a=25^\circ\text{C}$  (unless otherwise specified)**

Parameter	Symbol	Conditions	Values			Unit
			min.	typ.	max.	
Average Supply Current(no load)	$I_{DD}$	$V_{DD} = 17\text{V}$		3.5		mA
On resistance ( $R_{PMOS}+R_{NMOS}$ )	$R_{DS(ON)}$	$V_{DD} = 2.5\text{V}$	4.5	5.0	5.5	$\Omega$
		$V_{DD} = 17\text{V}$		2.5		
Thermal Shutdown Threshold	$T_{SHUT}$		150			°C
Locked Rotor Period	$T_{ON}$			0.4		s
Locked Rotor Period	$T_{OFF}$			4.1		s

**Magnetic Characteristics**

Parameter	Symbol	Conditions	Values			Unit
			min.	typ.	max.	
Operate Points	$B_{OP}$		5	25	50	G
Release Points	$B_{RP}$		-5	-25	-50	G
Hysteresis	$B_{HYS}$		10	50	100	G

**Driver output vs. Magnetic Pole**

Parameter	Test Conditions	NO	SO
North pole	$B < B_{rp}$	High	Low
South pole	$B > B_{op}$	Low	High

**Note:** The magnetic pole is applied facing the branded side of the package

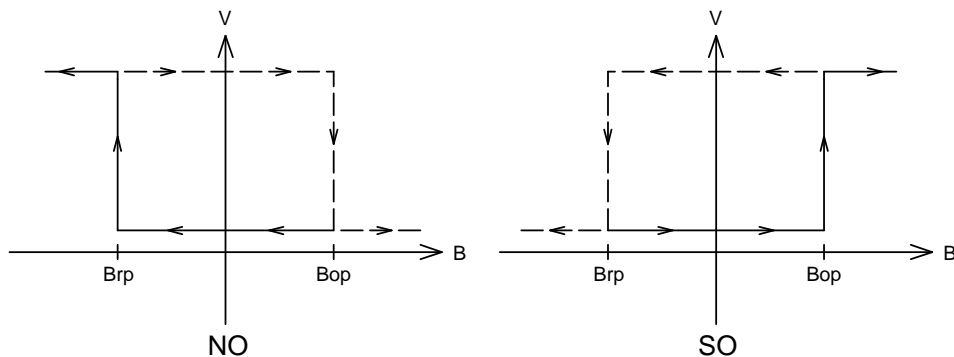
**Hysteresis Characteristics**

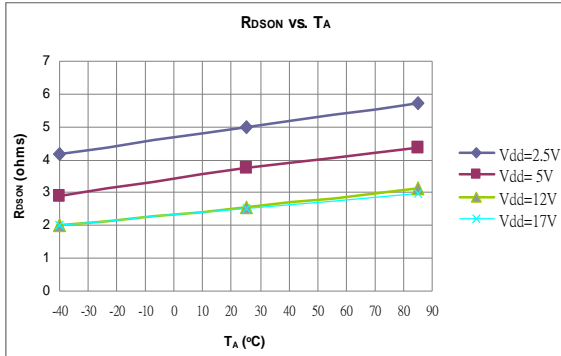
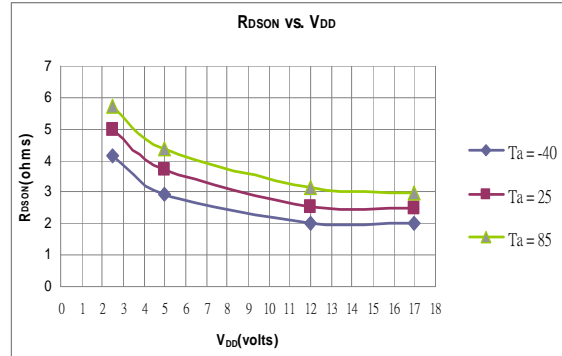
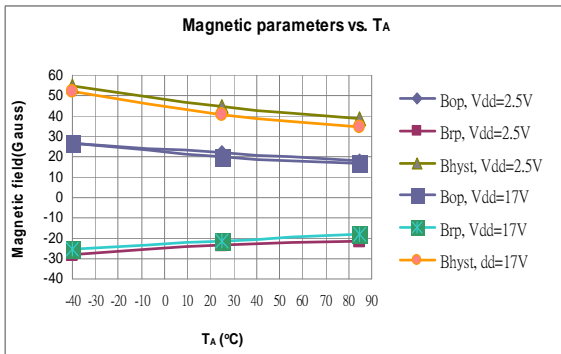
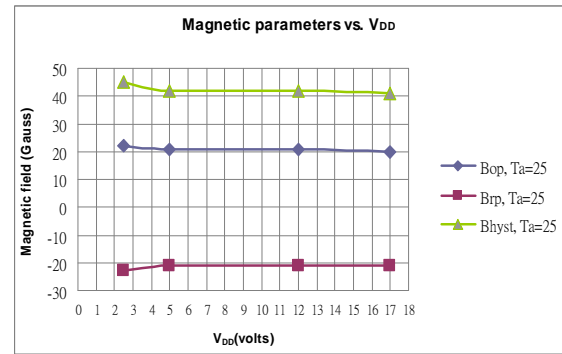
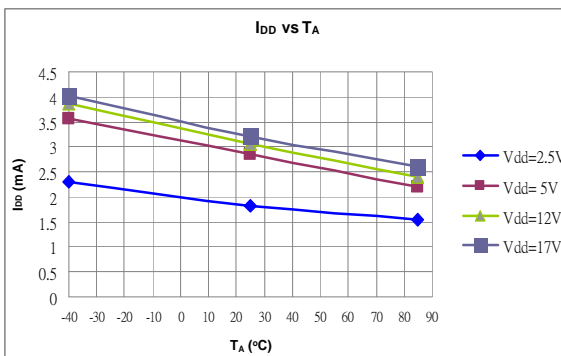
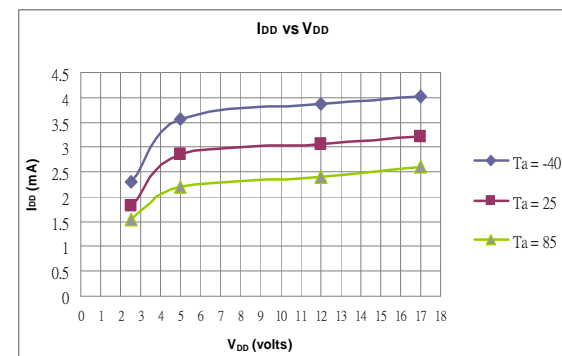
**Performance Graphs**

**Figure.4**

**Figure.5**

**Figure.6**

**Figure.7**

**Figure.8**

**Figure.9**



### Application Circuit Reference

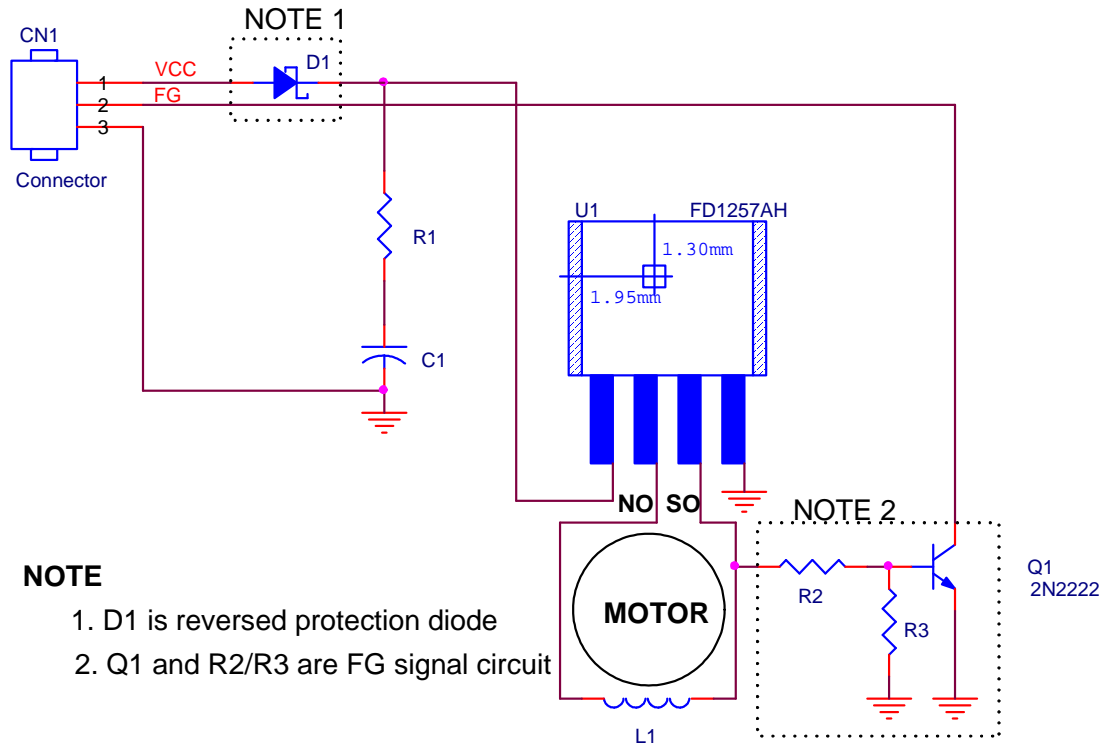

Figure.10 FD1257AH Typical Application Circuits

**Note:**

- 1). Must use least  $C1=1\mu F$ (electrolytic) capacitor &  $R1=0\sim 10$  Ohm for the decoupling between  $V_{DD}$  and  $V_{SS}$  and place the capacitor as close to the IC as possible.
- 2). D1 is a low forward diode for IC reversed supply voltage protection.



## FD1257AH Output Waveforms Description

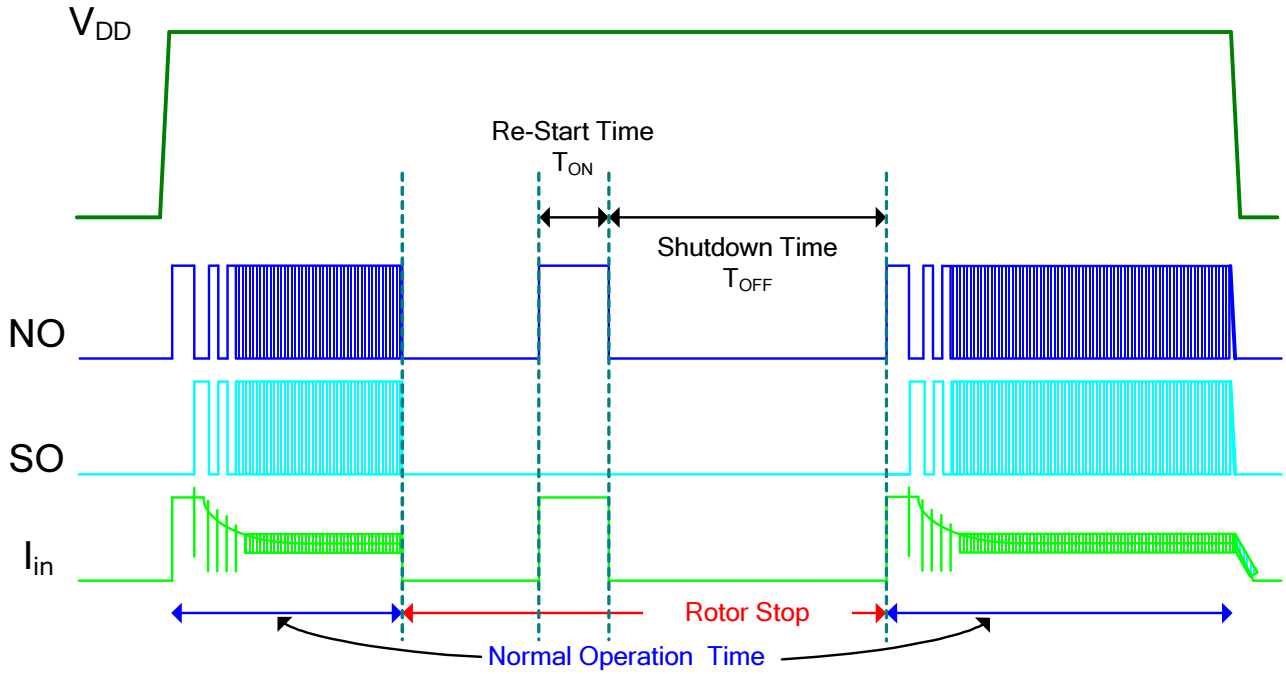

Figure.11



### FD1257AH Output Waveforms Measurement

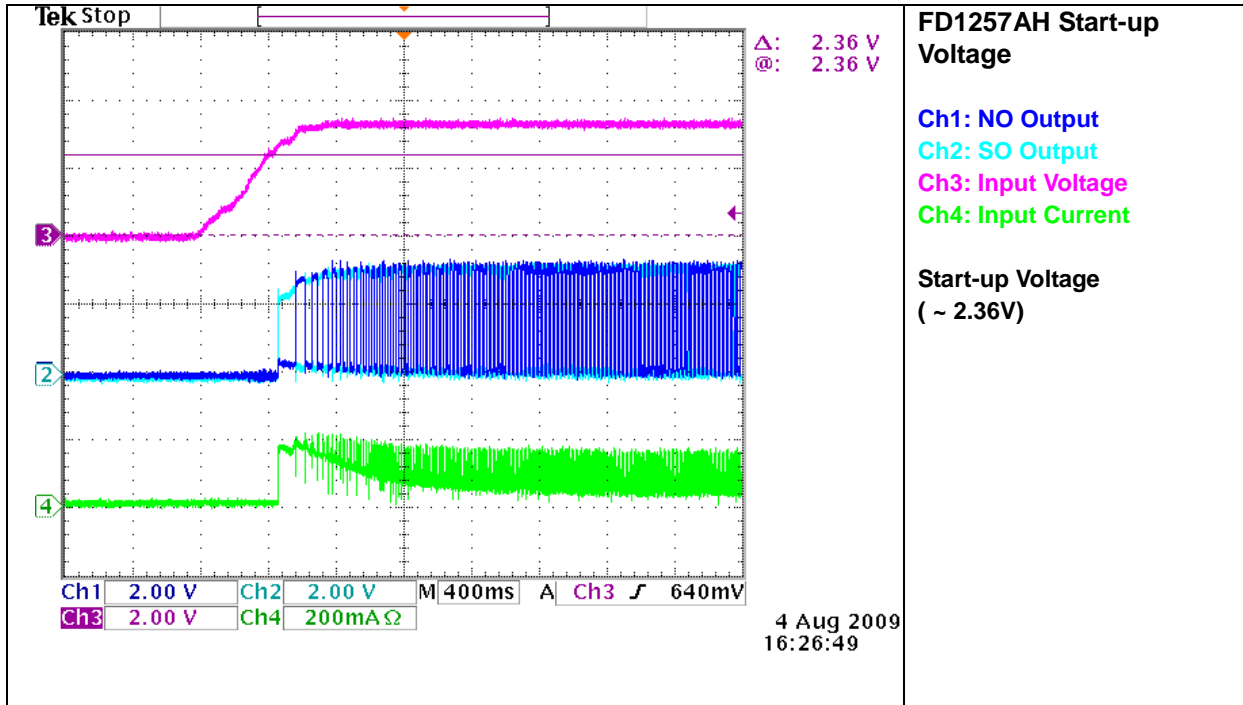

Figure.12

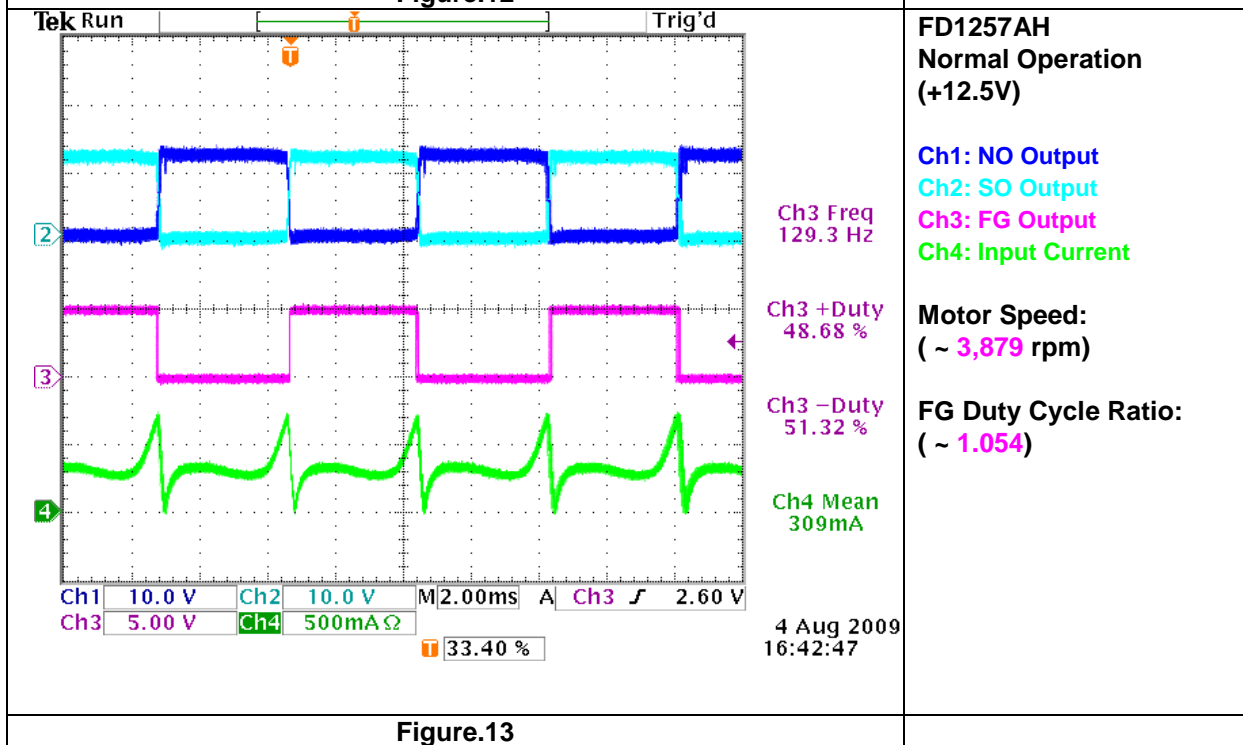
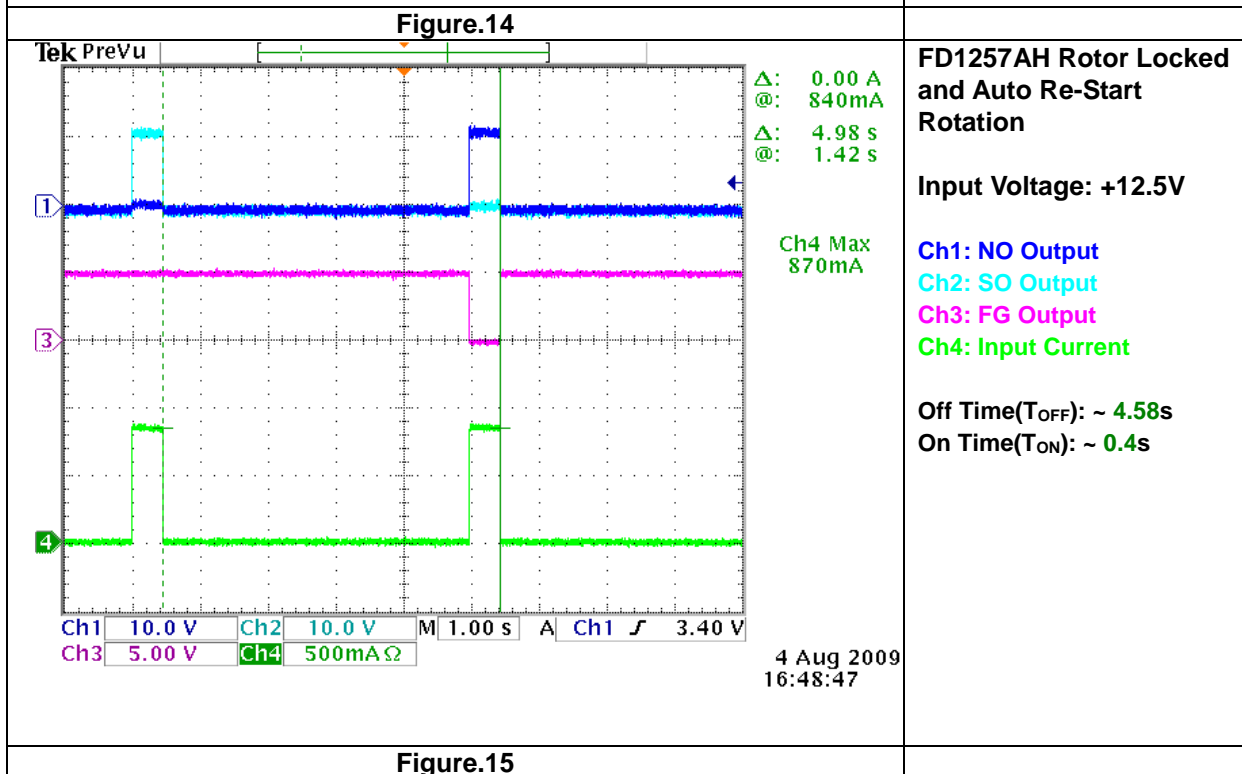
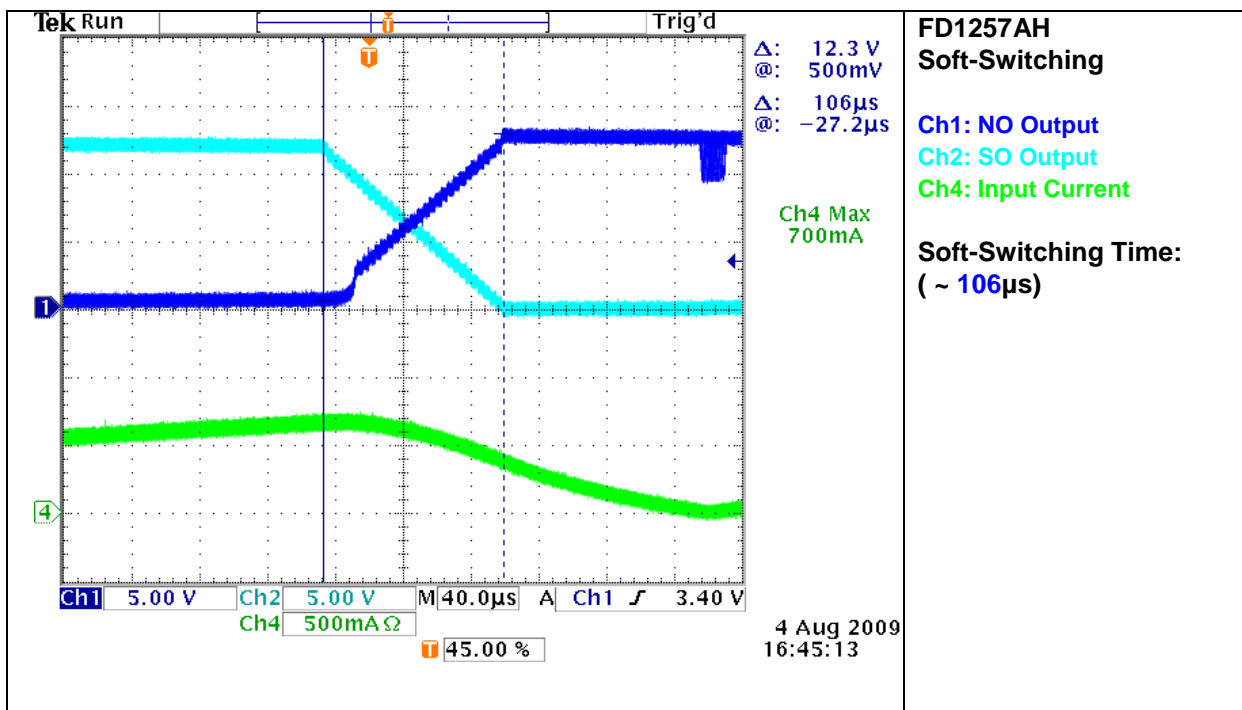
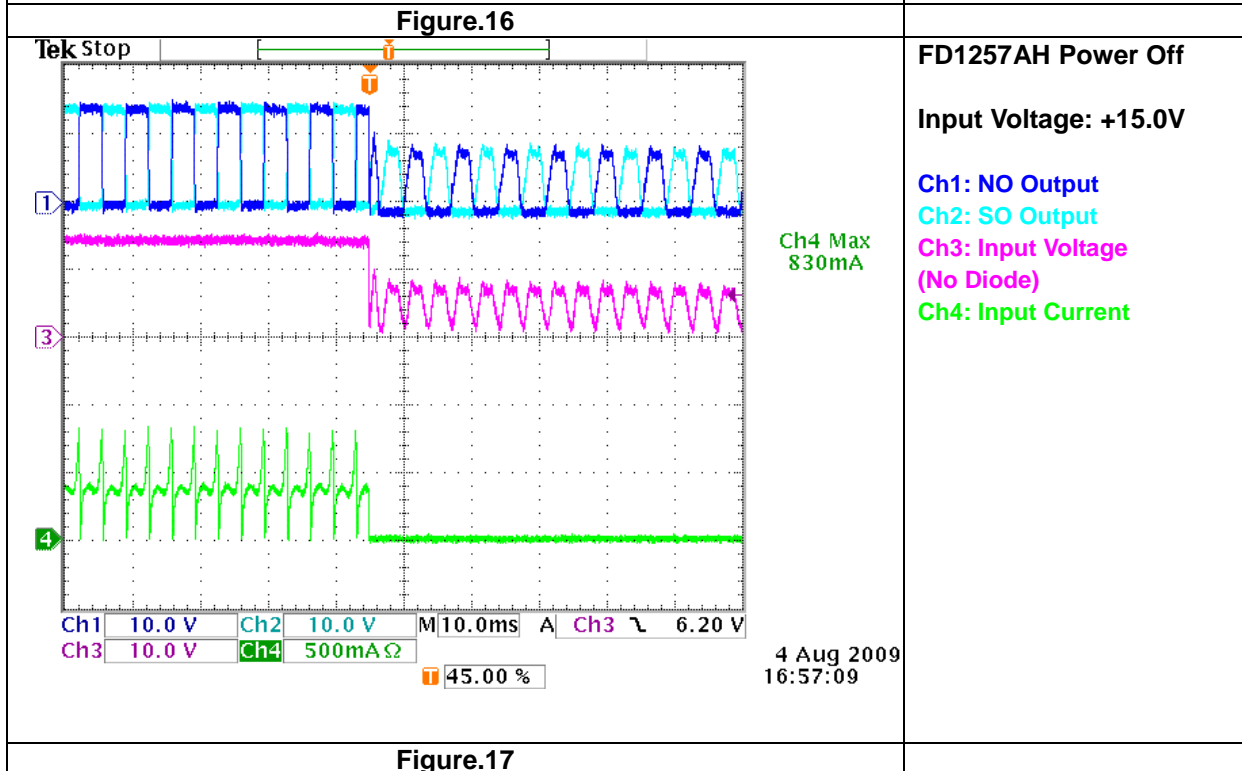
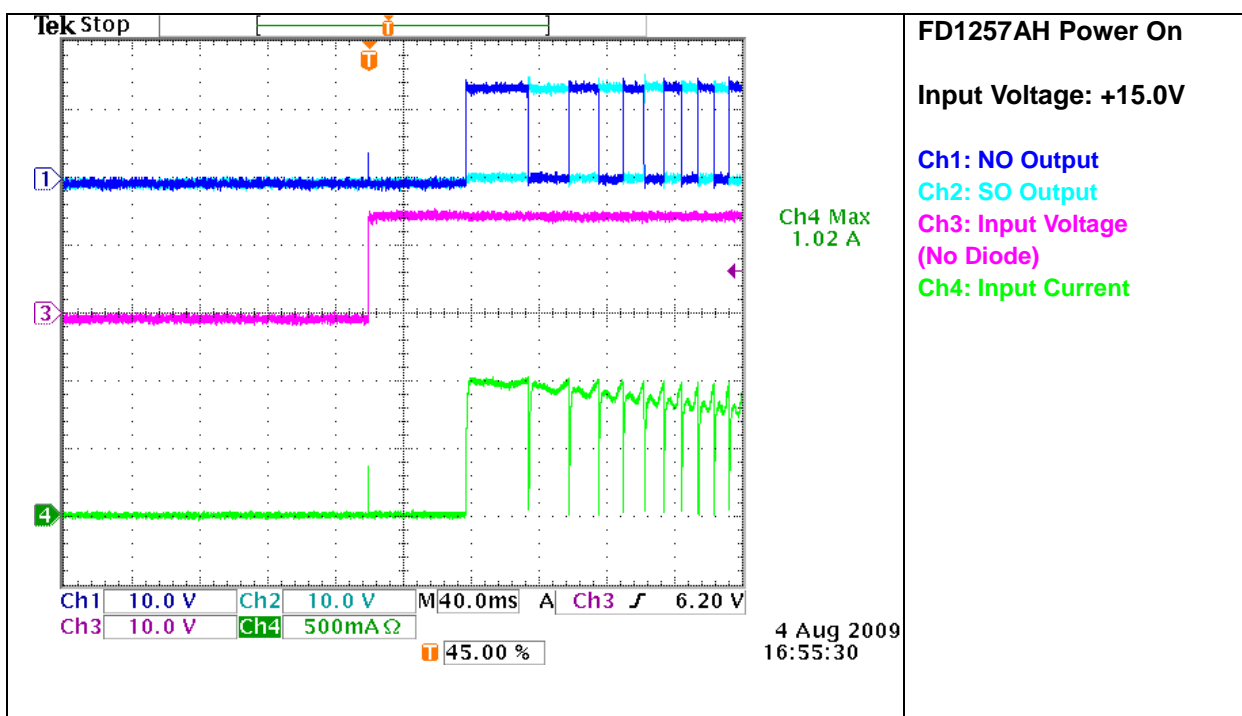

Figure.13









Package Dimension (Unit: mm)  
SIP-4L(Halogen Free)

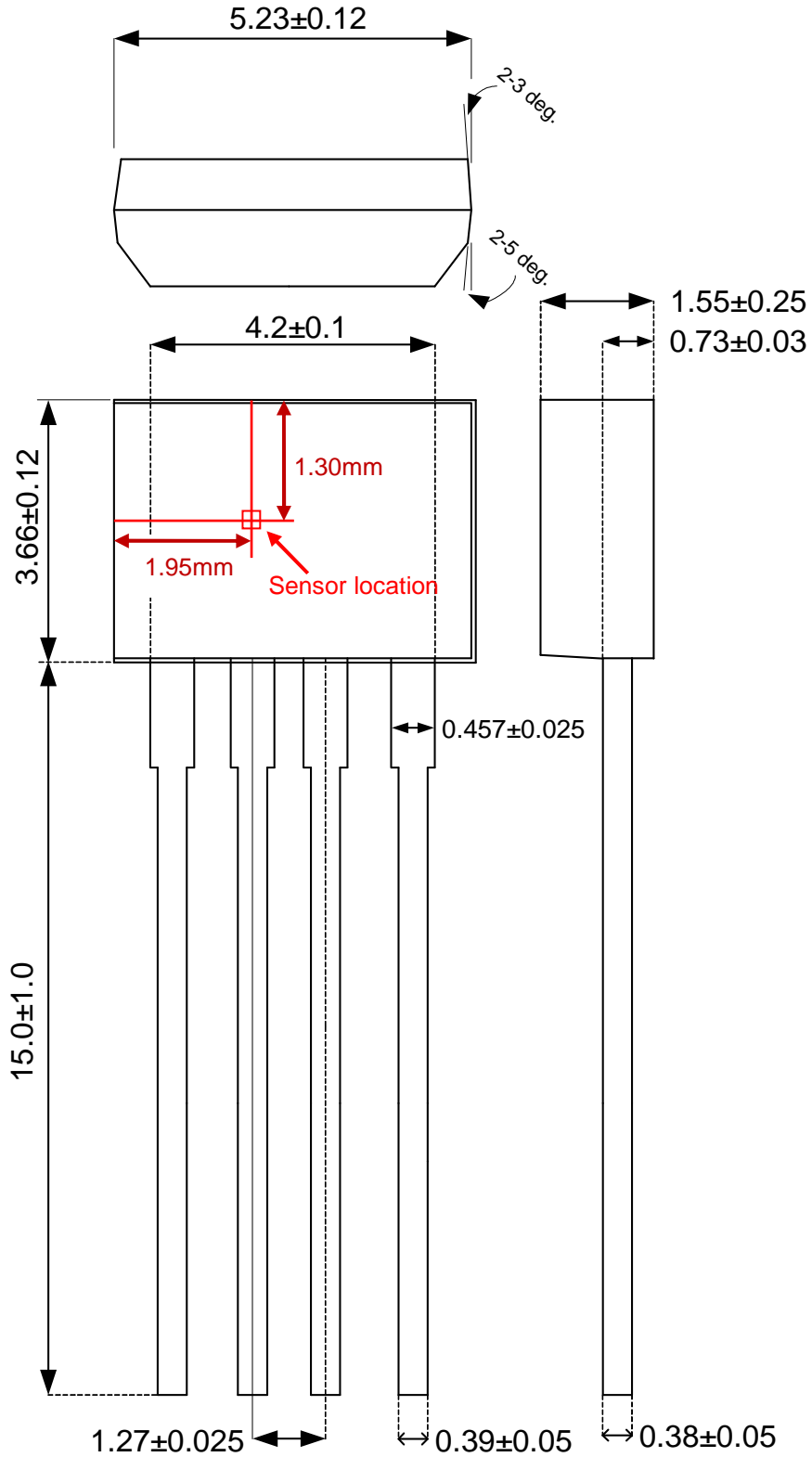

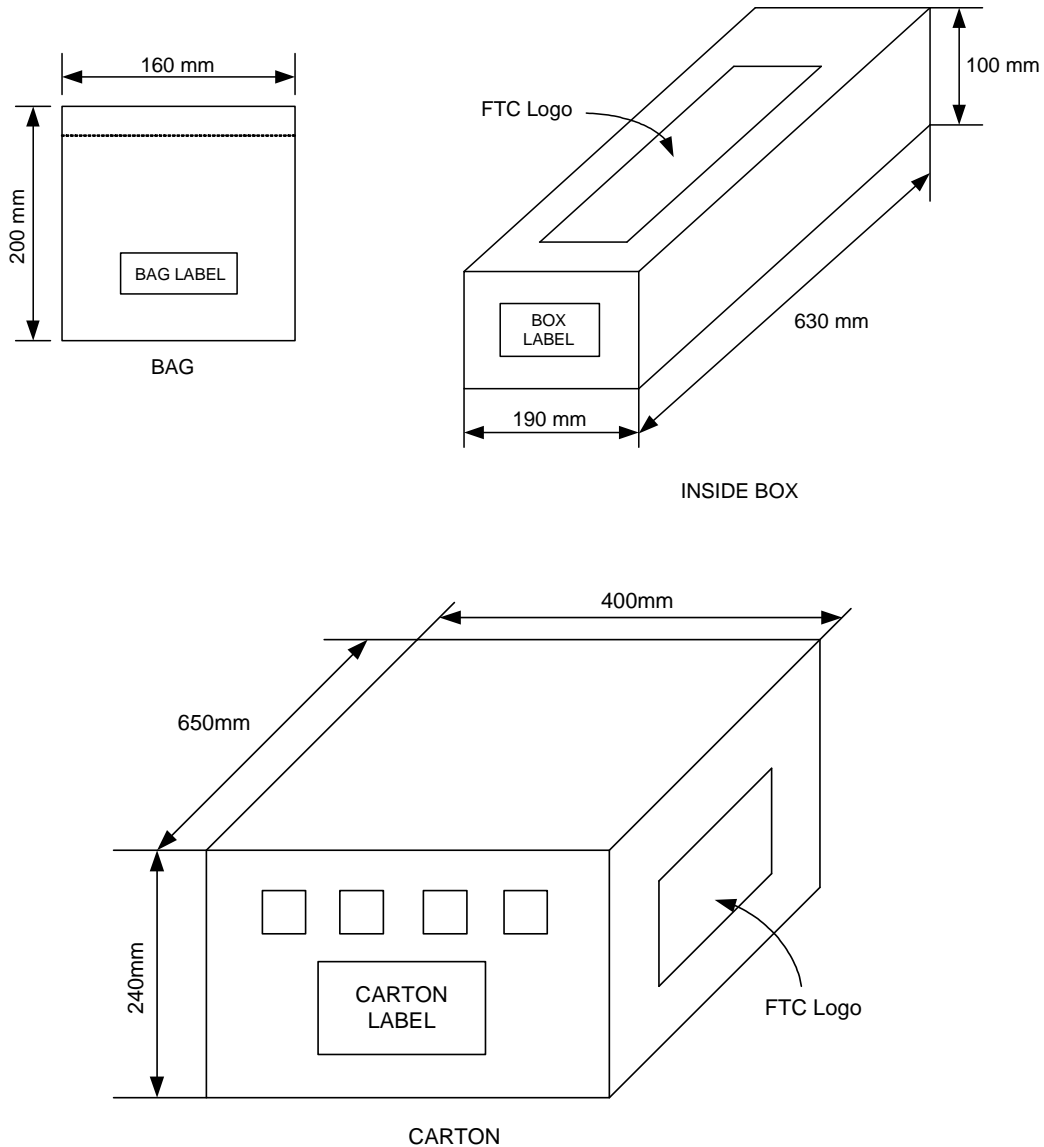
**Packing Specification**
**BAG & BOX DIMANSION**

**Packing Quantity Specifications**

1000 EA / 1 BAG

20 BAGS / 1 INSIDE BOX

4 INSIDE BOXES / 1 CARTON

**Order Information**

Part Number	Operating Temperature	Package	Description	MOQ	MSL
FD1257AH-G1	-40 °C to +85 °C	SIP-4L	±50G (B)	1,000 EA / BAG	3

## X-ON Electronics

Largest Supplier of Electrical and Electronic Components

*Click to view similar products for [Motor/Motion/Ignition Controllers & Drivers](#) category:*

*Click to view products by [Feeling manufacturer](#):*

Other Similar products are found below :

[LV8774Q-AH](#) [MC33931EKR2](#) [FSB50550TB2](#) [FSBF15CH60BTH](#) [MSVCPM2-63-12](#) [MSVGW45-14-2](#) [MSVGW54-14-3](#) [NTE7043](#)  
[LA6245P-CL-TLM-E](#) [LA6565VR-TLM-E](#) [LB11650-E](#) [LB1837M-TLM-E](#) [LB1845DAZ-XE](#) [LC898300XA-MH](#) [SS30-TE-L-E](#) [STK531-345A-E](#) [STK581U3A0D-E](#) [STK621-728S-E](#) [STK625-728-E](#) [STK672-400B-E](#) [AMIS30621AUA](#) [LV8281VR-TLM-H](#) [BA5839FP-E2](#)  
[IRAM236-1067A](#) [LA6584JA-AH](#) [LB11847L-E](#) [LB1845L-E](#) [LC898122XA-VH](#) [LC898212XD-SH](#) [NCV70501DW002R2G](#) [STK531U340A-E](#) [STK554U361A-E](#) [STK554U394A-E](#) [STK621-043D-E](#) [STK621-068R-E](#) [STK621-141A-E](#) [STK621-713-E](#) [STK672-600A](#) [STK760-221A-E](#) [STK760-304-E](#) [AH293-PL-B](#) [TND315S-TL-2H](#) [FNA23060](#) [FSB50250AB](#) [FNA41060](#) [MSVBTC50E](#) [MSVCPM3-54-12](#) [MSVCPM3-63-12](#) [MSVCPM4-63-12](#) [FSB50550AB](#)