



肖特极势垒二极管 SCHOTTKY BARRIER DIODE FHP20100A/FHF20100A

主要参数 MAIN CHARACTERISTICS

$I_F(AV)$	20(2×10)A
V_{RRM}	100 V
$V_F\text{-typ} (@I_F=10A)$	0.8V
T_J	150℃

用途 APPLICATIONS

高频开关电源	High frequency switch power supply
逆变器	Power management in inverter system
极性保护电路	Polarity protection application

封装形式 Package

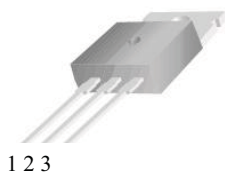

TO-220
FHP series

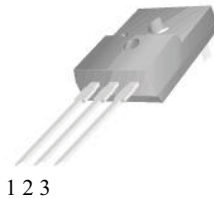

TO-220F
FHF series

产品特性 FEATURES

共阴结构	Common cathode structure
低功耗	Low power loss
高抗浪涌电流能力	Improved surge current capability
RoHS 产品	RoHS product

等效电路 Equivalent Circuit

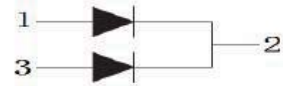

绝对最大额定值 ABSOLUTE RATINGS ($T_c=25^\circ\text{C}$)

项 目 Parameter	符 号 Symbol	数 值 Value	单 位 Unit
最大反向重复峰值电压 Repetitive peak reverse voltage	V_{RRM}	100	V
最大直流阻断电压 Maximum DC blocking voltage	V_{DC}	100	V
正向平均整流电流 Average forward current	$I_F(AV)$	20	A
整个器件 per device 单 侧 per diode		10	
正向峰值浪涌电流 Surge non repetitive forward current (额定负载 8.3ms 半正弦波—按 JEDEC 方法) 8.3 ms single half-sine-wave (JEDEC Method)	I_{FSM}	200	A
最高结温 Maximum junction temperature	T_J	150	℃
储存温度 Storage temperature range	T_{STG}	-40~+150	℃

电特性 ELECTRICAL CHARACTERISTICS

项 目 Parameter	测试条件 Tests conditions		最小值 Value (min)	典型值 Value (typ)	最大值 Value (max)	单 位 Unit
	T_a	V_R				
I_R	$T_a = 25^\circ\text{C}$	$V_R = V_{RRM}$	-	1.2	6	μA
	$T_a = 125^\circ\text{C}$		-	-	5	mA
V_F	$T_a = 25^\circ\text{C}$	$I_F = 10\text{A}$	-	0.8	0.85	V
	$T_a = 125^\circ\text{C}$		-	0.65	0.7	V

热特性 THERMAL CHARACTERISTIC

项 目 Parameter		符 号 Symbol	最大值 Value (max)	单 位 Unit
结到管壳的热阻 Thermal resistance from junction to case	TO-220	Rth(j-c)	1.9	°C/W
	TO-220F		3.5	

典型特性曲线

Typical Characteristics

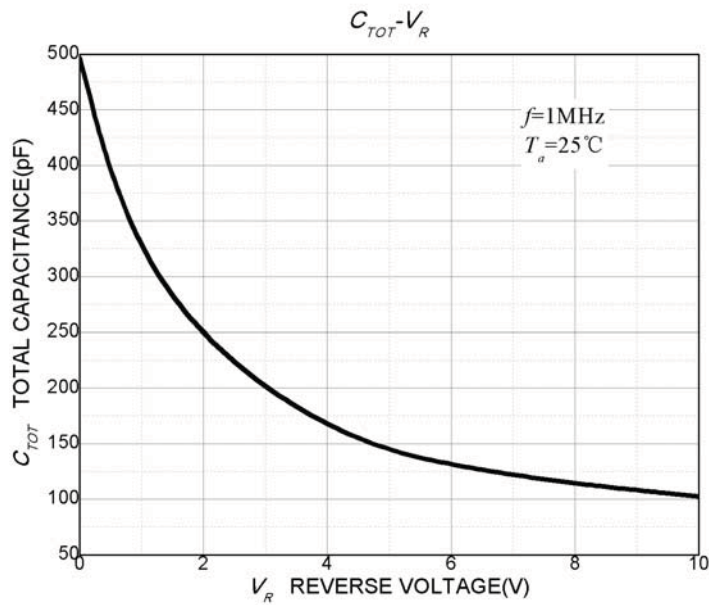
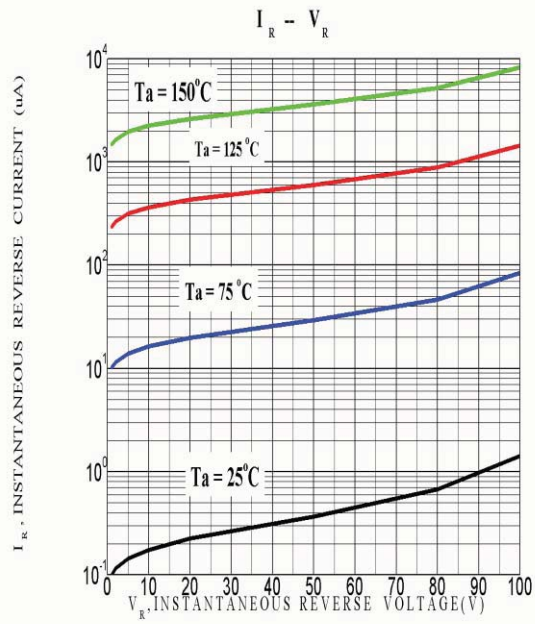
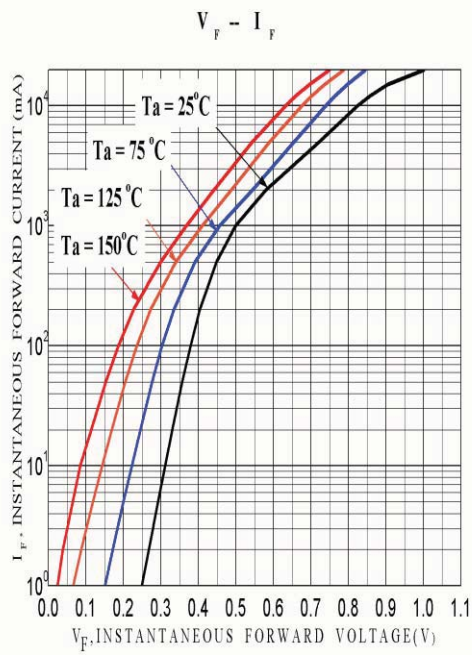

印记 Marking:

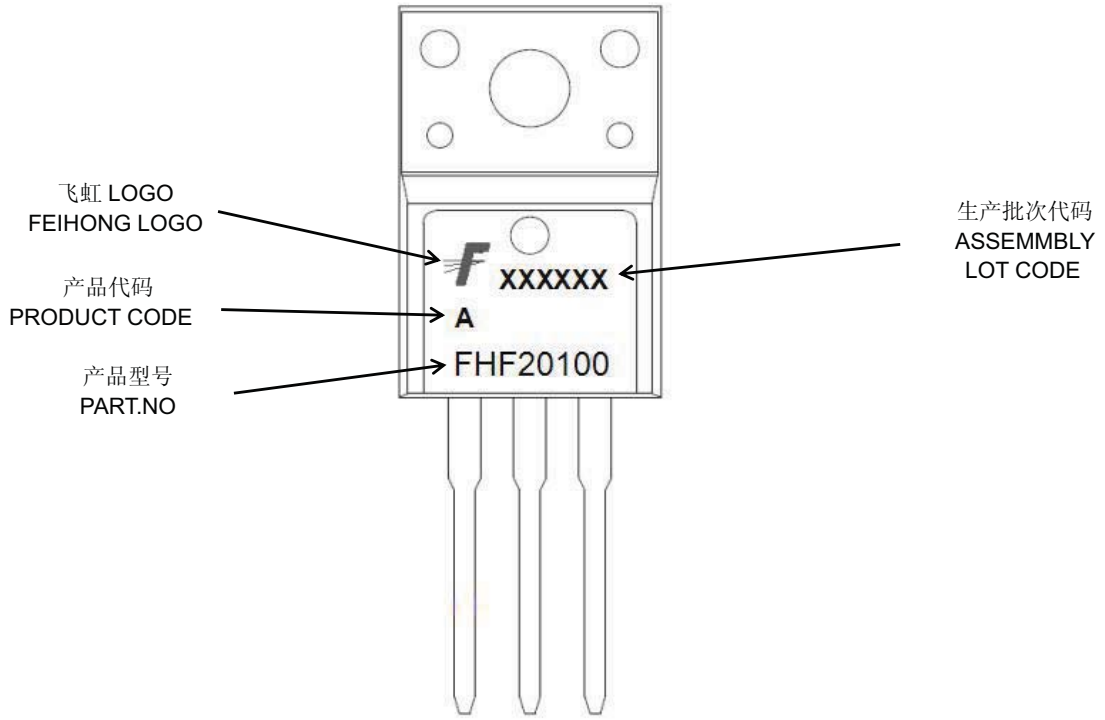
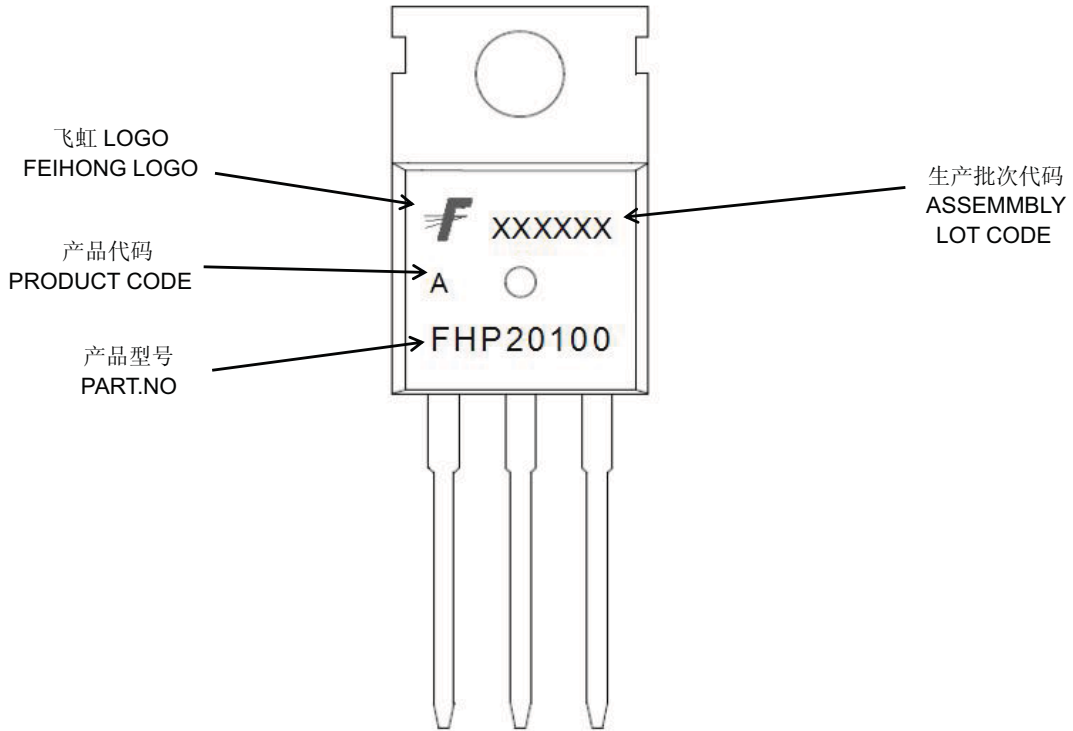

外形尺寸:

Package Dimension:

TO-220

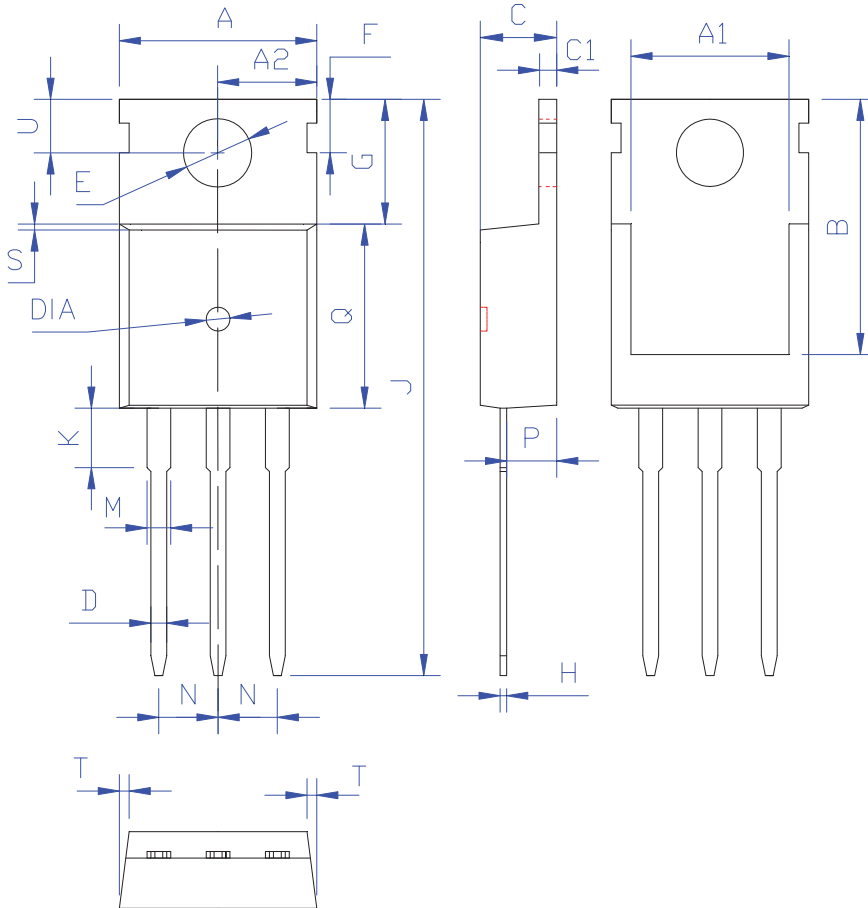

DIM	MILLIMETERS
A	10.00 ± 0.30
A1	8.00 ± 0.30
A2	5.00 ± 0.30
B	13.20 ± 0.40
C	4.50 ± 0.20
C1	1.30 ± 0.20
D	0.80 ± 0.20
E	3.60 ± 0.20
F	3.00 ± 0.30
G	6.60 ± 0.40
H	0.50 ± 0.20
J	28.88 ± 0.50
K	3.00 ± 0.30
M	1.30 ± 0.30
N	Typical 2.54
P	2.40 ± 0.40
Q	9.20 ± 0.40
S	0.25 ± 0.15
T	0.25 ± 0.15
U	2.80 ± 0.30
DIA	宽 1.50 ± 0.10 深 0.50 MAX

(Unit: mm)

外形尺寸:

Package Dimension:

TO-220F

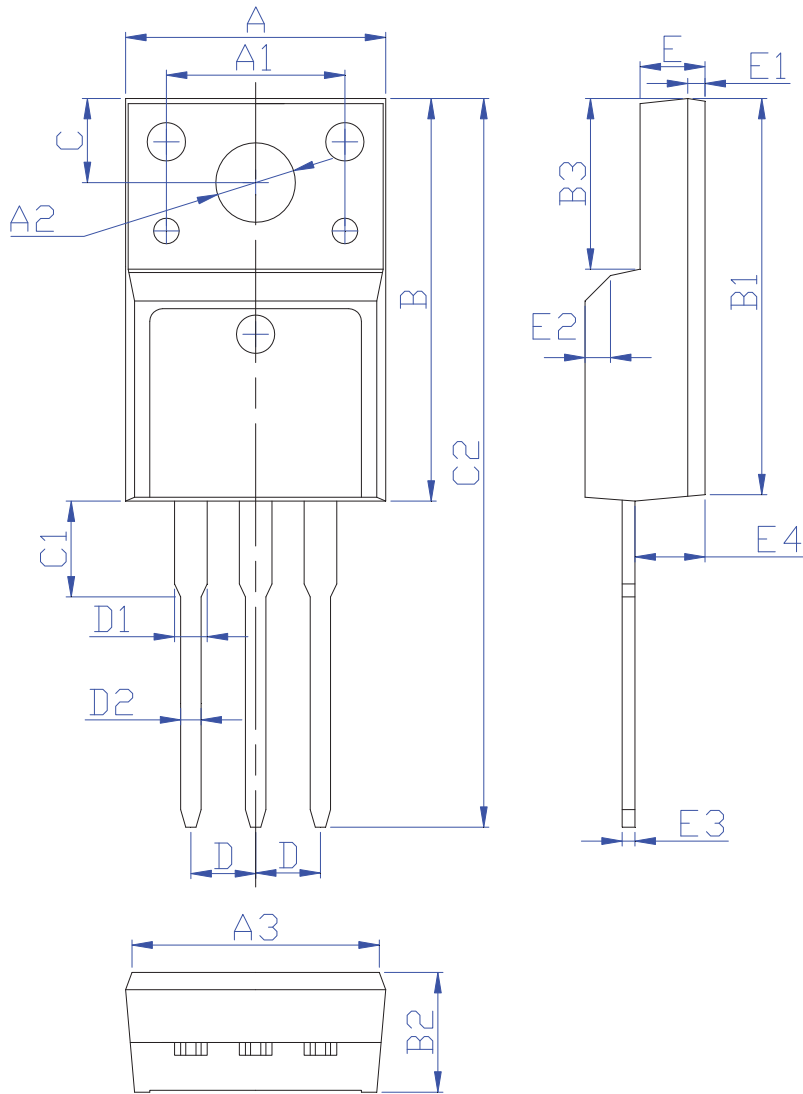

DIM	MILLIMETERS
A	10.16±0.30
A1	7.00±0.20
A2	3.12±0.20
A3	9.70±0.30
B	15.90±0.50
B1	15.60±0.50
B2	4.70±0.30
B3	6.70±0.30
C	3.30±0.25
C1	3.25±0.30
C2	28.70±0.50
D	Typical 2.54
D1	1.47 (MAX)
D2	0.80±0.20
E	2.55±0.25
E1	0.70±0.25
E2	1.0×45°
E3	0.50±0.20
E4	2.75±0.30

(Unit:mm)

X-ON Electronics

Largest Supplier of Electrical and Electronic Components

Click to view similar products for [Schottky Diodes & Rectifiers](#) category:

Click to view products by [FeiHong](#) manufacturer:

Other Similar products are found below :

[CUS06\(TE85L,Q,M\)](#) [MA4E2039](#) [D1FH3-5063](#) [MBR0530L-TP](#) [MBR10100CT-BP](#) [MBR30H100MFST1G](#) [MMBD301M3T5G](#) [PMAD1103-LF](#) [PMAD1108-LF](#) [RB160M-50TR](#) [RB520S-30](#) [RB551V-30](#) [DD350N18K](#) [DZ435N40K](#) [DZ600N16K](#) [BAS16E6433HTMA1](#) [BAS 3010S-02LRH E6327](#) [BAT 54-02LRH E6327](#) [IDL02G65C5XUMA1](#) [NSR05F40QNXT5G](#) [NSVR05F40NXT5G](#) [JANS1N6640](#) [SB07-03C-TB-H](#) [SB1003M3-TL-W](#) [SBAT54CWT1G](#) [SBM30-03-TR-E](#) [SBS818-TL-E](#) [SK32A-LTP](#) [SK33A-TP](#) [SK34A-TP](#) [SK34B-TP](#) [SMD1200PL-TP](#) [ACDBN160-HF](#) [SS3003CH-TL-E](#) [STPS30S45CW](#) [PDS3100Q-7](#) [GA01SHT18](#) [CRS10I30A\(TE85L,QM\)](#) [MBR1240MFST1G](#) [MBRB30H30CT-1G](#) [BAS28E6433HTMA1](#) [BAS 70-02L E6327](#) [HSB123JTR-E](#) [JANTX1N5712-1](#) [VS-STPS40L45CW-N3](#) [DD350N12K](#) [SB007-03C-TB-E](#) [SB10015M-TL-E](#) [SB1003M3-TL-E](#) [SK110-LTP](#)