



N 沟道增强型场效应晶体管

N-CHANNEL MOSFET

FHP12N60A/ FHF12N60A

主要参数 MAIN CHARACTERISTICS

ID	12A
VDSS	600V
Rdson-typ(@Vgs=10V)	0.6Ω
Qg-typ	52nC

产品特性 FEATURES

低栅极电荷	Low gate charge
低 Crss (典型值 18pF)	Low Crss (typical 18pF)
开关速度快	Fast switching
100%经过雪崩测试	100% avalanche tested
高抗 dv/dt 能力	Improved dv/dt capability
RoHS 产品	RoHS product

用途 APPLICATION

高频开关电源	High efficiency switch mode power supplies
电子镇流器	Electronic ballast
LED 电源	LED power supply

封装形式 Package

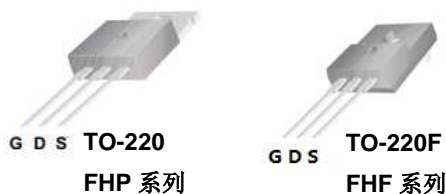

等效电路 Equivalent Circuit

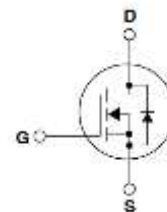

绝对最大额定值 ABSOLUTE RATINGS (Tc=25°C)

项目 Parameter	符号 Symbol	数值 Value		单位 Unit
		FHP12N60A	FHF12N60A	
最高漏极-源极直流电压 Drain-Source Voltage	VDS	600		V
连续漏极电流* Drain Current -continuous *	ID (TC=25°C) ID (TC=100°C)	12*	7*	A
最大脉冲漏极电流 (注 1) Drain Current – pulse (note 1)	IDM	48*		A
最高栅源电压 Gate-Source Voltage	VGS	±30		V
单脉冲雪崩能量 (注 2) Single Pulsed Avalanche Energy (note 2)	EAS	929		mJ
雪崩电流 (注 1) Avalanche Current (note 1)	IAR	12		A
重复雪崩能量 (注 1) Repetitive Avalanche Current (note 1)	EAR	23.1		mJ
二极管反向恢复最大电压变化速率 (注 3) Peak Diode Recovery dv/dt (note 3)	dv/dt	4.5		V/ns
耗散功率 Power Dissipation	PD (TC=25°C)	231	54	W
	-Derate above 25°C	1.85	0.43	W/°C
最高结温及存储温度 Operating and Storage Temperature Range	TJ, TSTG	150, -55 to 150		°C
引线最高焊接温度 Maximum Lead Temperature for Soldering Purposes	TL	300		°C

*漏极电流由最高结温限制 Drain current limited by maximum junction temperature

电特性 ELECTRICAL CHARACTERISTICS

项目 Parameter	符号 Symbol	测试条件 Tests conditions	最小 Min	典型 Typ	最大 Max	单位 Units
关态特性 Off –Characteristics						
漏—源击穿电压 Drain-Source Voltage	BVDSS	ID=250μA, VGS=0V	600	-	-	V
击穿电压温度特性 Breakdown Voltage Temperature Coefficient	ΔBVDSS/Δ TJ	ID=250μA, referenced to 25°C	-	0.7	-	V/°C
零栅压下漏极漏电流 Zero Gate Voltage Drain Current	IDSS	VDS=600V, VGS=0V, TC=25°C	-	-	1	μA
		VDS=480V, TC=125°C	-	-	10	μA
栅极体漏电流 Gate-body leakage current	IGSS (F/R)	VDS=0V, VGS =±30V	-	-	±100	μA
通态特性 On-Characteristics						
阈值电压 Gate Threshold Voltage	VGS(th)	VDS = VGS , ID=250μA	2.0	-	4.0	V
静态导通电阻 Static Drain-Source On-Resistance	RDS(ON)	VGS =10V , ID=6A	-	0.6	0.75	Ω
动态特性 Dynamic Characteristics						
输入电容 Input capacitance	Ciss	VDS=25V, VGS =0V, f=1.0MHz	-	1850	-	pF
输出电容 Output capacitance	Coss		-	180	-	
反向传输电容 Reverse transfer capacitance	Crss		-	20	-	
开关特性 Switching Characteristics						
延迟时间 Turn-On delay time	td(on)	VDS=300V, ID=12A, RG=25Ω (note 4, 5)	-	30	-	ns
上升时间 Turn-On rise time	tr		-	90	-	ns
延迟时间 Turn-Off delay time	td(off)		-	140	-	ns
下降时间 Turn-Off Fall time	tf		-	90	-	ns
栅极电荷总量 Total Gate Charge	Qg	VDS =480V , ID=12A , VGS =10V (note 4, 5)	-	52	-	nC
栅—源电荷 Gate-Source charge	Qgs		-	8.5	-	nC
栅—漏电荷 Gate-Drain charge	Qgd		-	20	-	nC
漏—源二极管特性及最大额定值 Drain-Source Diode Characteristics and Maximum Ratings						
正向最大连续电流 Maximum Continuous Drain -Source Diode Forward Current		IS	-	-	12	A
正向最大脉冲电流 Maximum Pulsed Drain-Source Diode Forward Current		ISM	-	-	48	A
正向压降 Drain-Source Diode Forward Voltage	VSD	VGS=0V, IS=12A	-	-	1.4	V
反向恢复时间 Reverse recovery time	trr	VGS=0V, IS=12A ,dIF/dt=100A/μs (note 4)	-	430	-	ns
反向恢复电荷 Reverse recovery charge	Qrr		-	5.0	-	μC

热特性 THERMAL CHARACTERISTIC

项目 Parameter	符号 Symbol	FHP12N60A	FHF12N60A	单位 Unit
结到管壳的热阻 Thermal Resistance, Junction to Case	Rth(j-c)	0.54	2.33	°C/W
结到环境的热阻 Thermal Resistance, Junction to Ambient	Rth(j-A)	62.5	62.5	°C/W

注释:

Notes:

- 1: 脉冲宽度由最高结温限制
 - 2: L=11mH, I_D=13A, V_{DD}=48V, R_G=25 Ω, 起始结温 T_J=25°C
 - 3: I_{SD} ≤10A, di/dt ≤200A/μs, V_{DD} ≤B_VDSS, 起始结温 T_J=25°C
 - 4: 脉冲测试: 脉冲宽度 ≤300μs, 占空比 ≤2%
 - 5: 基本与工作温度无关
-
- 1: Pulse width limited by maximum junction temperature
 - 2: L=11mH, I_D=13A, V_{DD}=48V, R_G=25 Ω, Start T_J=25°C.
 - 3: I_{SD} ≤10A, di/dt ≤200A/μs, V_{DD} ≤B_VDSS, Starting T_J=25°C
 - 4: Pulse Test: Pulse Width ≤300μs, Duty Cycle ≤2%
 - 5: Essentially independent of operating temperatur

特性曲线

ELECTRICAL CHARACTERISTICS (curves)

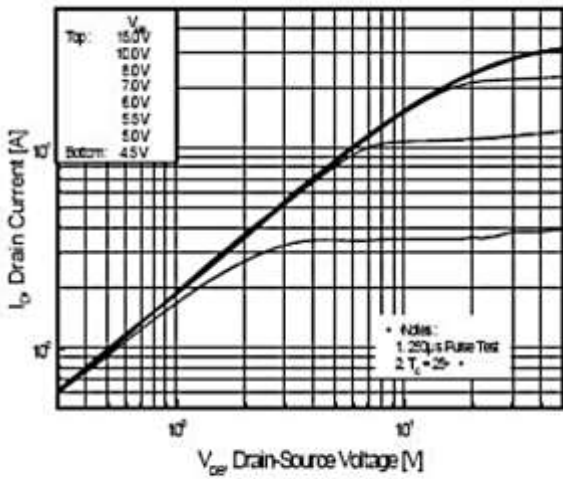

Figure 1. On-Region Characteristics

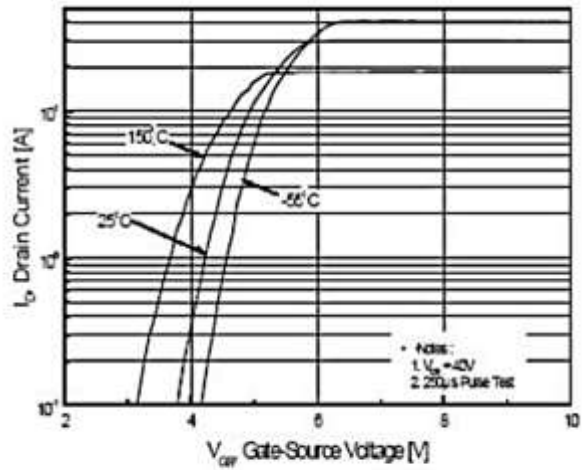

Figure 2. Transfer Characteristics

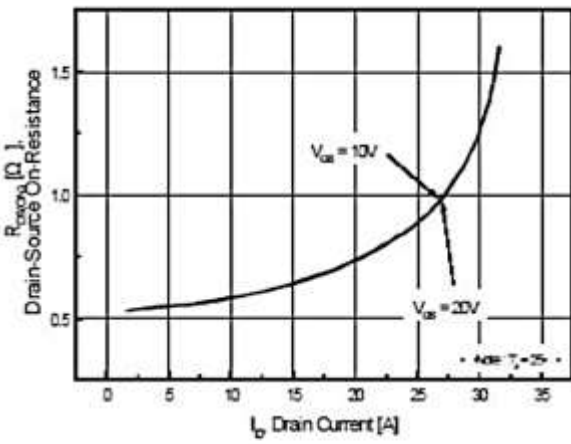

Figure 3. On-Resistance Variation vs Drain Current and Gate Voltage

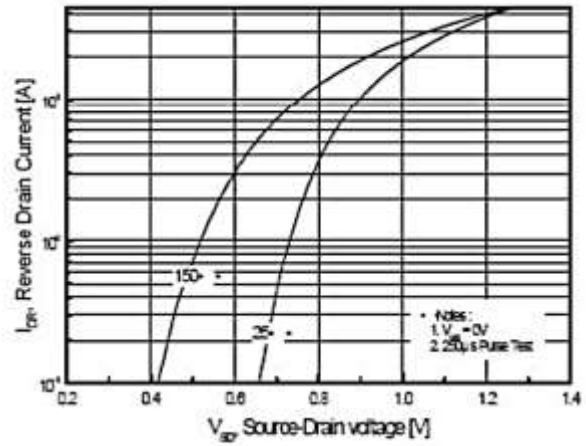

Figure 4. Body Diode Forward Voltage Variation with Source Current and Temperature

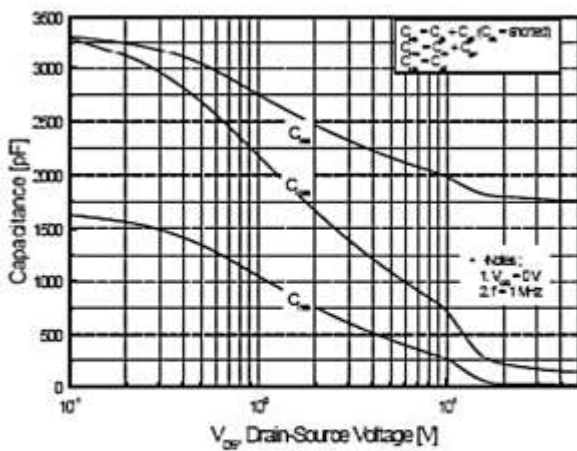

Figure 5. Capacitance Characteristics

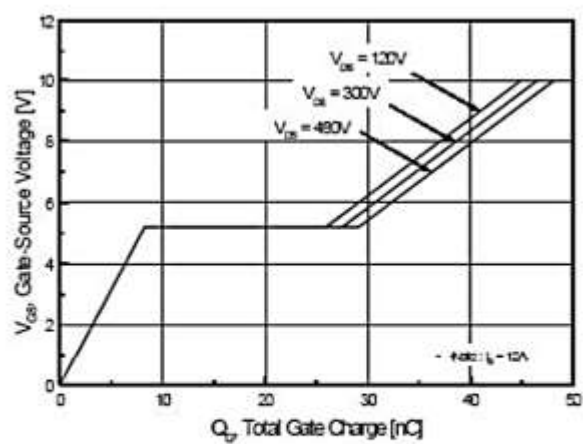

Figure 6. Gate Charge Characteristics

特性曲线

ELECTRICAL CHARACTERISTICS (curves)

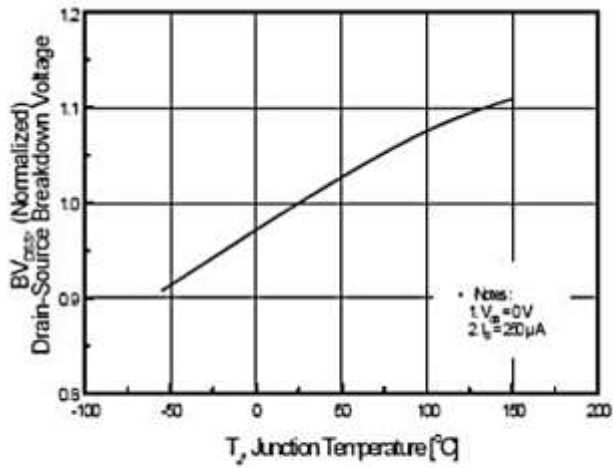

Figure 7. Breakdown Voltage Variation vs Temperature

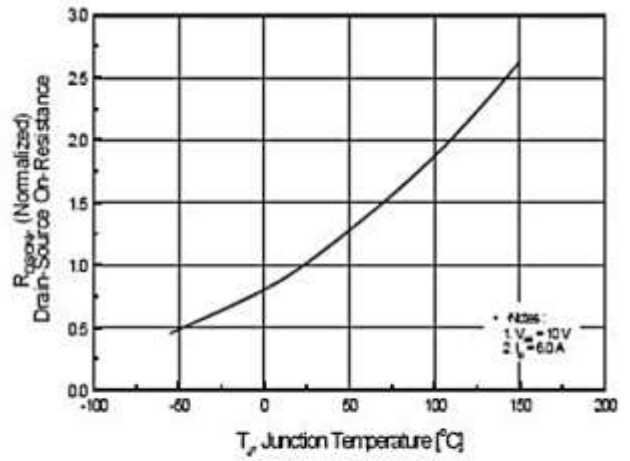

Figure 8. On-Resistance Variation vs Temperature

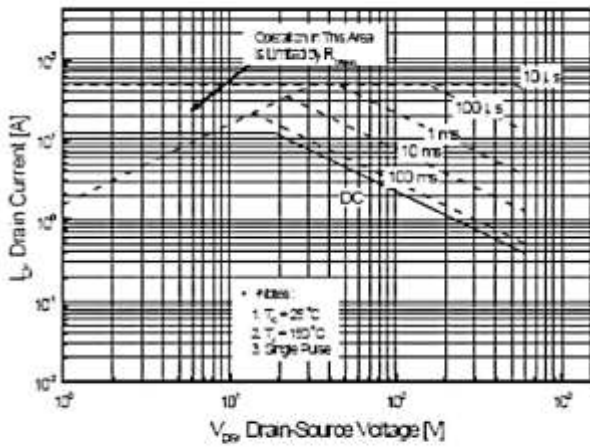

Figure 9-1. Maximum Safe Operating Area TO-220

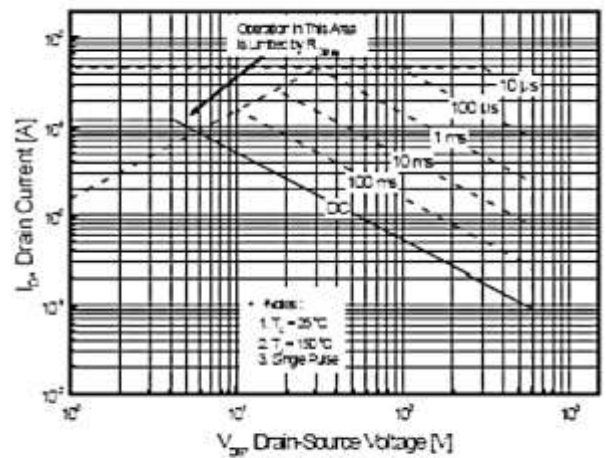

Figure 9-2. Maximum Safe Operating Area TO-220F

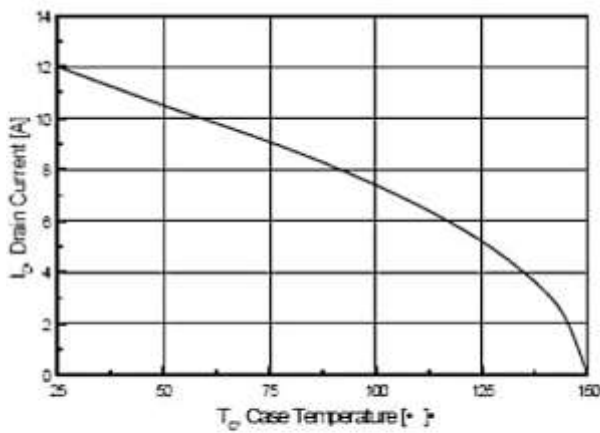

Figure 10. Maximum Drain Current vs Case Temperature

特性曲线

ELECTRICAL CHARACTERISTICS (curves)

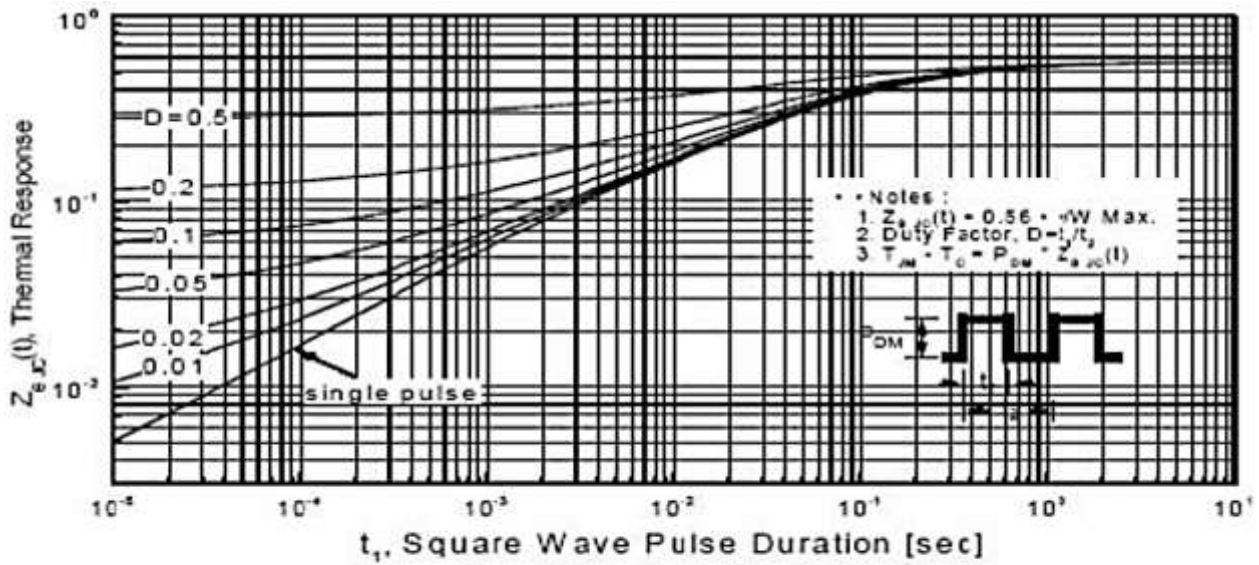

Figure 11-1. Transient Thermal Response Curve

TO-220

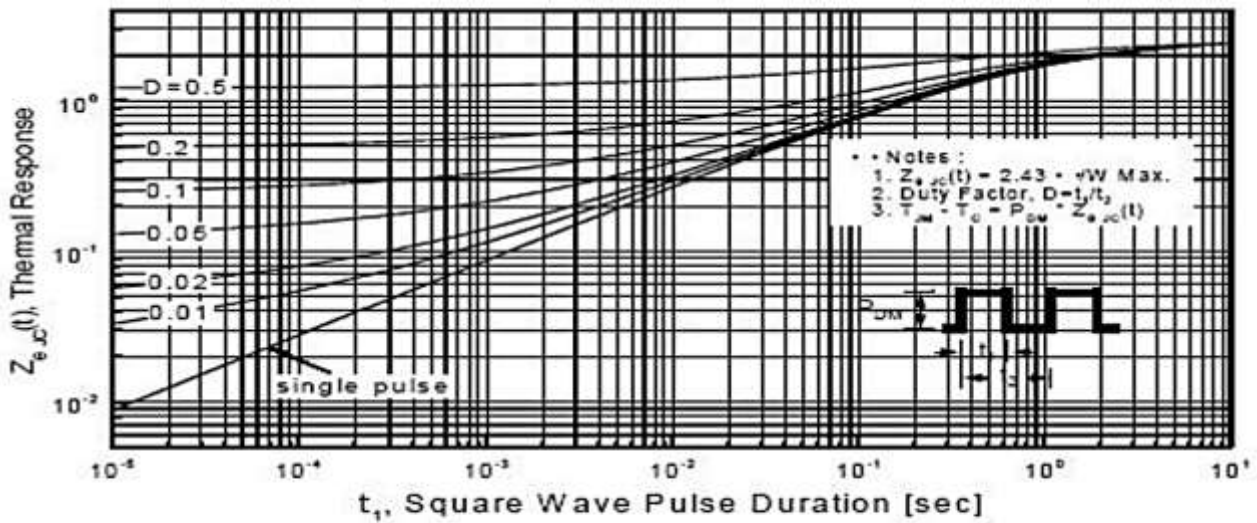
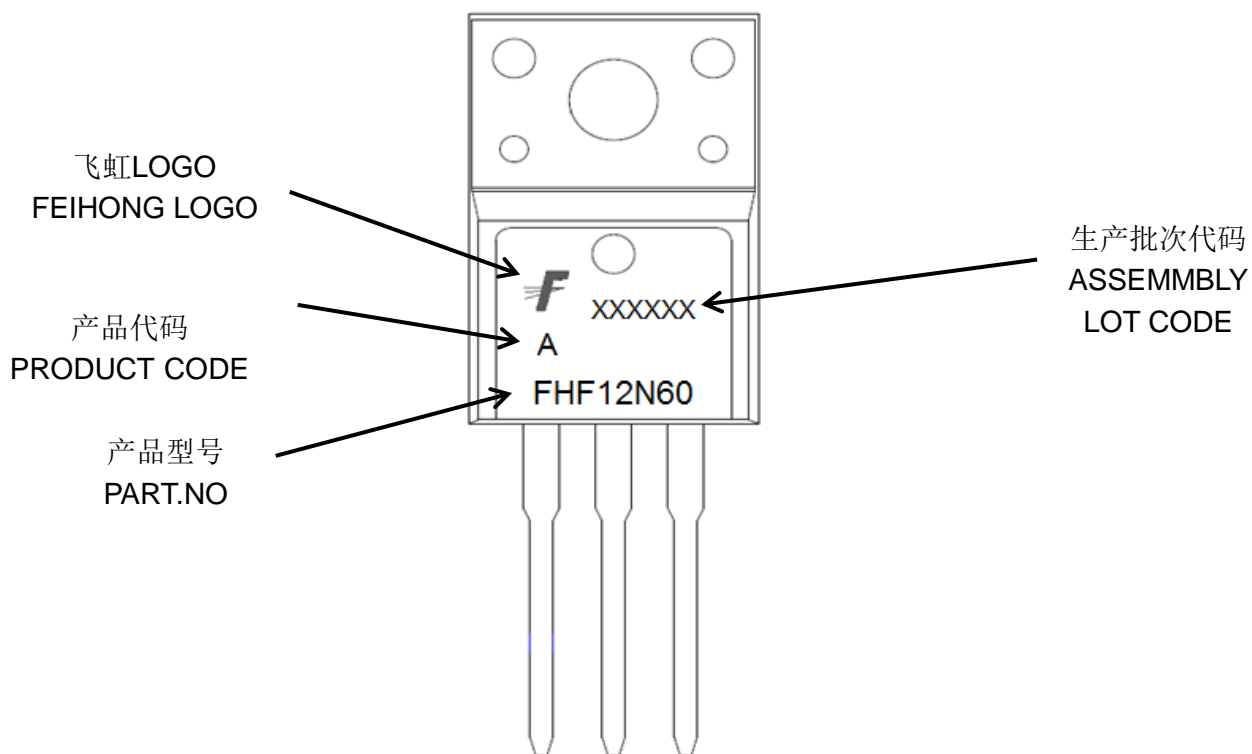
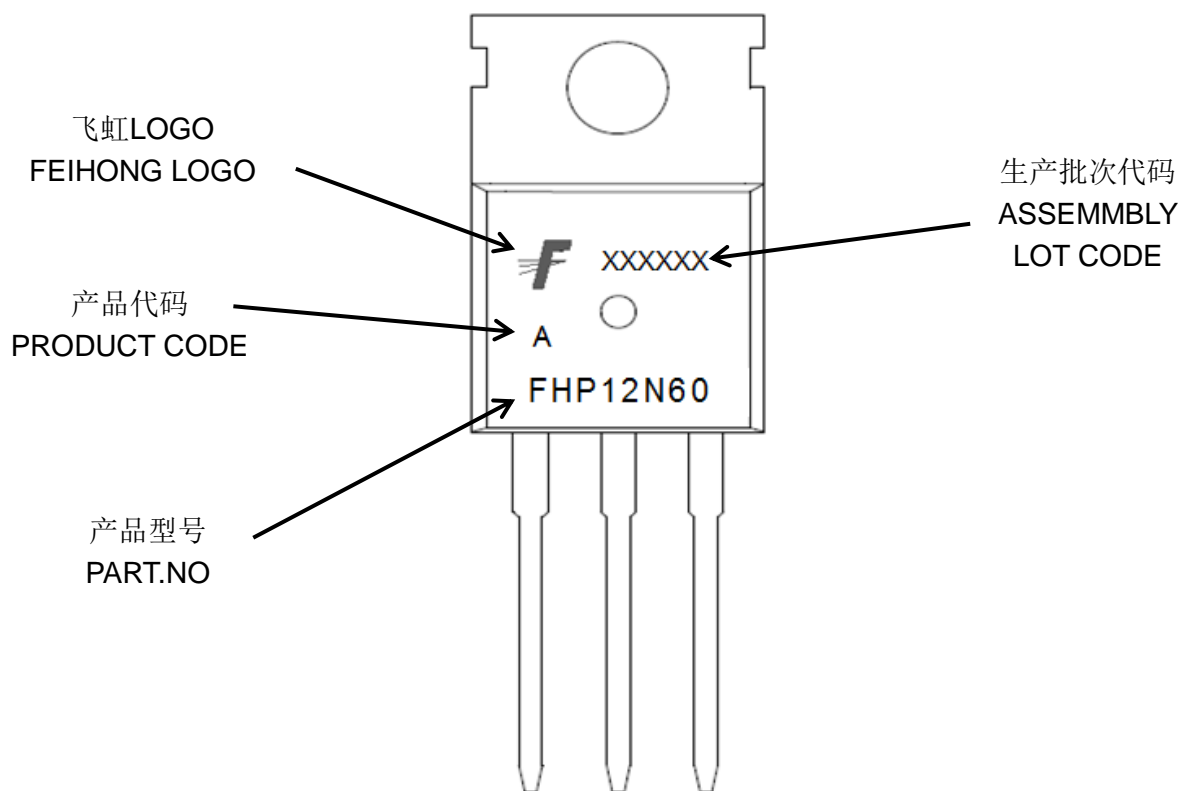

Figure 11-2. Transient Thermal Response Curve

TO-220F

印记 Marking



外形尺寸:

Package Dimension:

TO-220

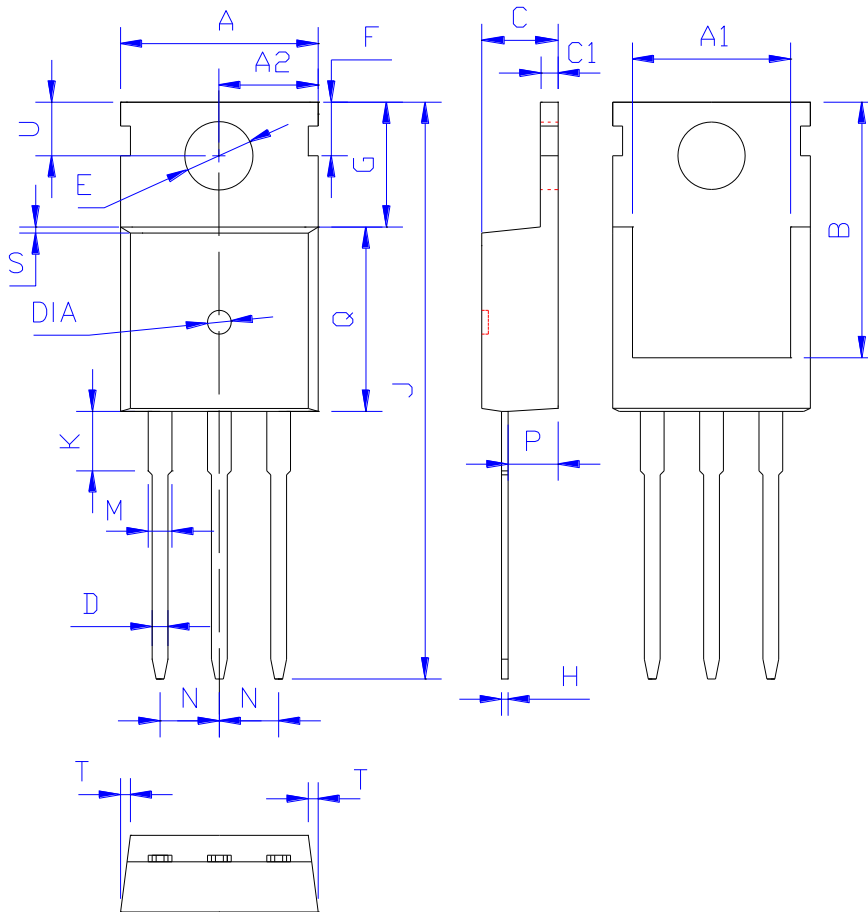

DIM	MILLIMETERS
A	10.00 ± 0.30
A1	8.00 ± 0.30
A2	5.00 ± 0.30
B	13.20 ± 0.40
C	4.50 ± 0.20
C1	1.30 ± 0.20
D	0.80 ± 0.20
E	3.60 ± 0.20
F	3.00 ± 0.30
G	6.60 ± 0.40
H	0.50 ± 0.20
J	28.88 ± 0.50
K	3.00 ± 0.30
M	1.30 ± 0.30
N	Typical 2.54
P	2.40 ± 0.40
Q	9.20 ± 0.40
S	0.25 ± 0.15
T	0.25 ± 0.15
U	2.80 ± 0.30
DIA	宽 1.50 ± 0.10 深 0.50 MAX

(Units: mm)

外形尺寸:

Package Dimension:

TO-220F

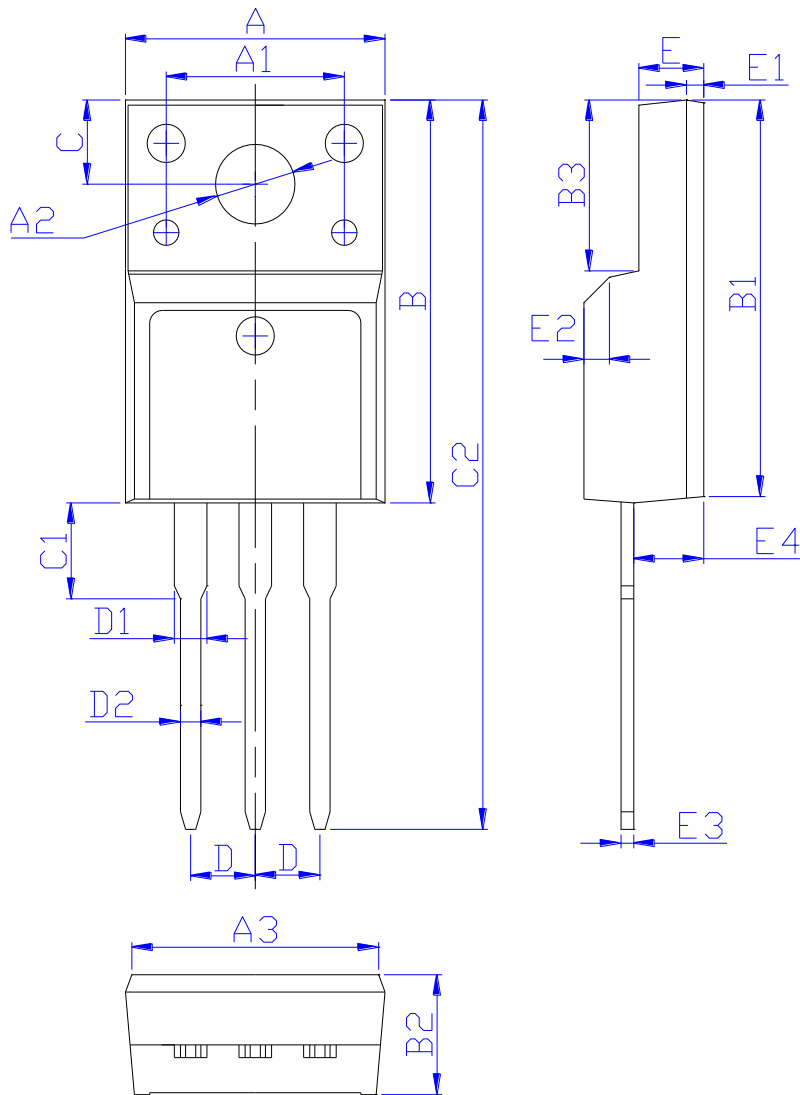

DIM	MILLIMETERS
A	10.16±0.30
A1	7.00±0.20
A2	3.12±0.20
A3	9.70±0.30
B	15.90±0.50
B1	15.60±0.50
B2	4.70±0.30
B3	6.70±0.30
C	3.30±0.25
C1	3.25±0.30
C2	28.70±0.50
D	Typical 2.54
D1	1.47 (MAX)
D2	0.80±0.20
E	2.55±0.25
E1	0.70±0.25
E2	1.0×45°
E3	0.50±0.20
E4	2.75±0.30

(Units : mm)

X-ON Electronics

Largest Supplier of Electrical and Electronic Components

Click to view similar products for [MOSFET](#) category:

Click to view products by [FeiHong](#) manufacturer:

Other Similar products are found below :

[614233C](#) [648584F](#) [MCH3443-TL-E](#) [MCH6422-TL-E](#) [FDPF9N50NZ](#) [FW216A-TL-2W](#) [FW231A-TL-E](#) [APT5010JVR](#) [NTNS3A92PZT5G](#)
[IRF100S201](#) [JANTX2N5237](#) [2SK2464-TL-E](#) [2SK3818-DL-E](#) [FCA20N60_F109](#) [FDZ595PZ](#) [STD6600NT4G](#) [FSS804-TL-E](#) [2SJ277-DL-E](#)
[2SK1691-DL-E](#) [2SK2545\(Q,T\)](#) [D2294UK](#) [405094E](#) [423220D](#) [MCH6646-TL-E](#) [TPCC8103,L1Q\(CM](#) [367-8430-0972-503](#) [VN1206L](#)
[424134F](#) [026935X](#) [051075F](#) [SBVS138LT1G](#) [614234A](#) [715780A](#) [NTNS3166NZT5G](#) [751625C](#) [873612G](#) [IRF7380TRHR](#)
[IPS70R2K0CEAKMA1](#) [RJK60S3DPP-E0#T2](#) [RJK60S5DPK-M0#T0](#) [APT5010JVFR](#) [APT12031JFLL](#) [APT12040JVR](#) [DMN3404LQ-7](#)
[NTE6400](#) [JANTX2N6796U](#) [JANTX2N6784U](#) [JANTXV2N5416U4](#) [SQM110N05-06L-GE3](#) [SIHF35N60E-GE3](#)