



肖特极势垒二极管 SCHOTTKY BARRIER DIODE FHP20100A/FHF20100A

主要参数 MAIN CHARACTERISTICS

$I_{F(AV)}$	20(2×10)A
V_{RRM}	100 V
V_F -typ (@ $I_F=10A$)	0.8V
T_J	150℃

产品特性 FEATURES

共阴结构	Common cathode structure
低功耗	Low power loss
高抗浪涌电流能力	Improved surge current capability
RoHS 产品	RoHS product

用途 APPLICATIONS

高频开关电源	High frequency switch power supply
逆变器	Power management in inverter system
极性保护电路	Polarity protection application

封装形式 Package

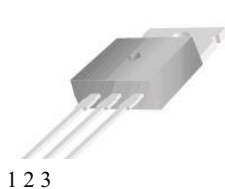

TO-220
FHP series

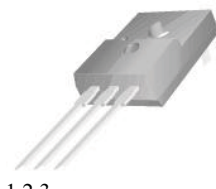

TO-220F
FHF series

等效电路 Equivalent Circuit

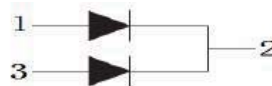

绝对最大额定值 ABSOLUTE RATINGS ($T_c=25^\circ C$)

项 目 Parameter	符 号 Symbol	数 值 Value	单 位 Unit
最大反向重复峰值电压 Repetitive peak reverse voltage	V_{RRM}	100	V
最大直流阻断电压 Maximum DC blocking voltage	V_{DC}	100	V
正向平均整流电流 Average forward current	$I_{F(AV)}$	20	A
整个器件 per device 单 侧 per diode		10	
正向峰值浪涌电流 Surge non repetitive forward current (额定负载 8.3ms 半正弦波—按 JEDEC 方法) 8.3 ms single half-sine-wave (JEDEC Method)	I_{FSM}	200	A
最高结温 Maximum junction temperature	T_J	150	℃
储存温度 Storage temperature range	T_{STG}	-40~+150	℃

电特性 ELECTRICAL CHARACTERISTICS

项 目 Parameter	测试条件 Tests conditions		最小值 Value (min)	典型值 Value (typ)	最大值 Value (max)	单 位 Unit
	T_a	V_R				
I_R	$T_a = 25^\circ C$	$V_R = V_{RRM}$	-	1.2	6	μA
	$T_a = 125^\circ C$		-	-	5	mA
V_F	$T_a = 25^\circ C$	$I_F = 10A$	-	0.8	0.85	V
	$T_a = 125^\circ C$		-	0.65	0.7	V

热特性 THERMAL CHARACTERISTIC

项 目 Parameter		符 号 Symbol	最大值 Value (max)	单 位 Unit
结到管壳的热阻 Thermal resistance from junction to case	TO-220	Rth(j-c)	1.9	°C/W
	TO-220F		3.5	

典型特性曲线

Typical Characteristics

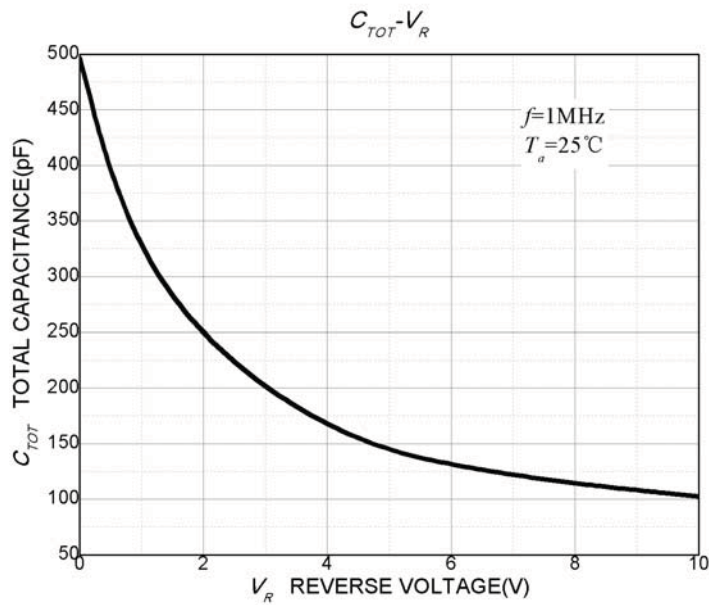
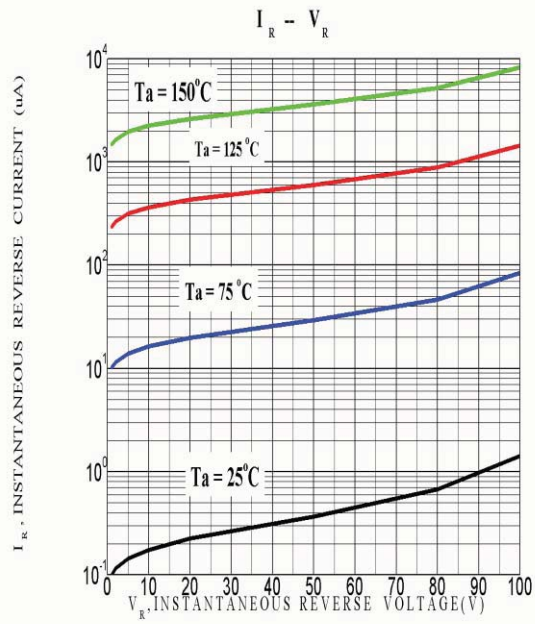
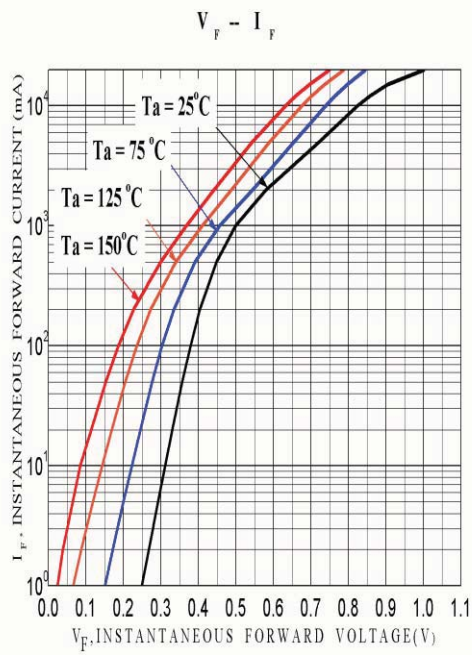

印记 Marking:

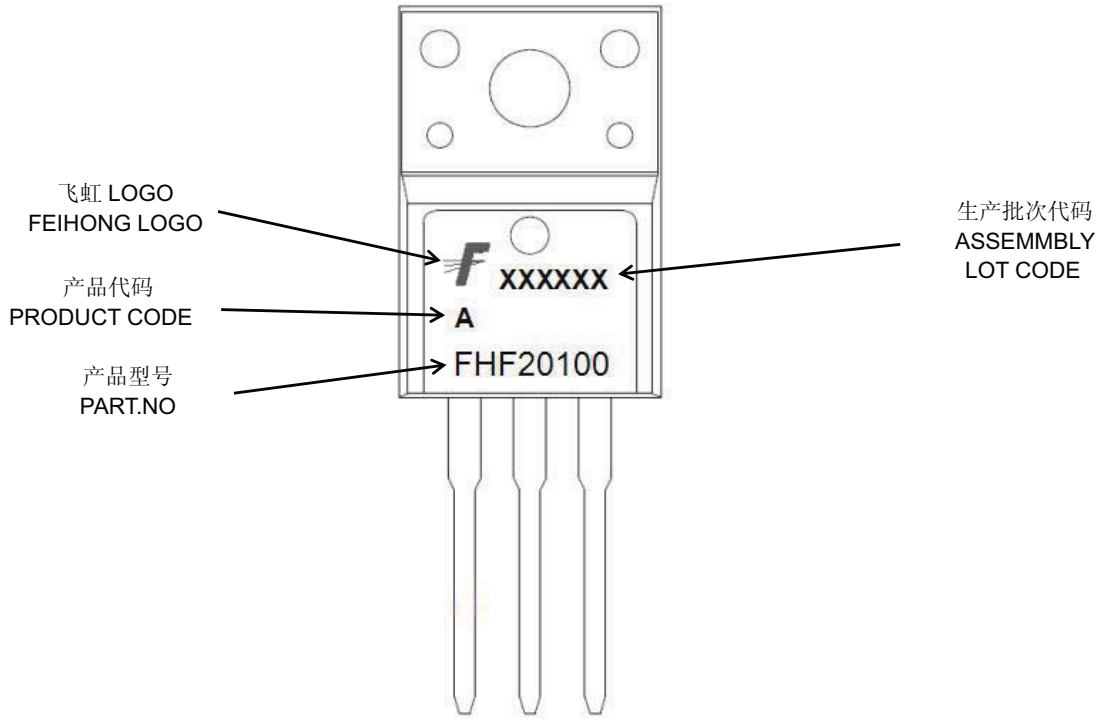
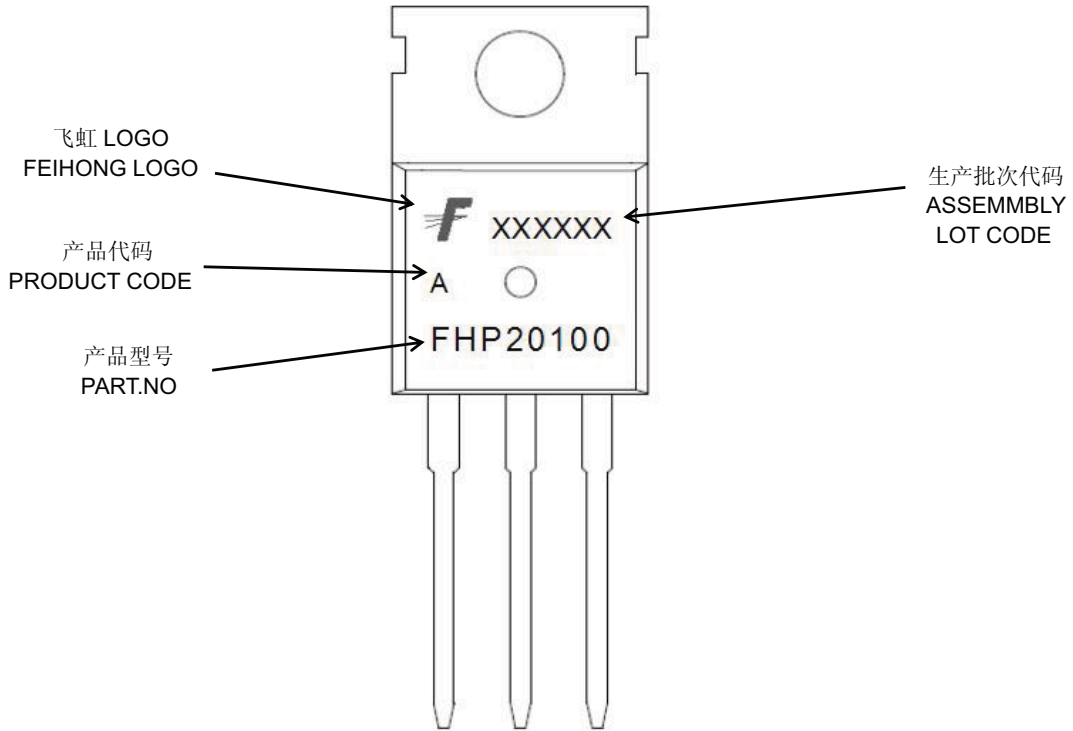

外形尺寸:

Package Dimension:

TO-220

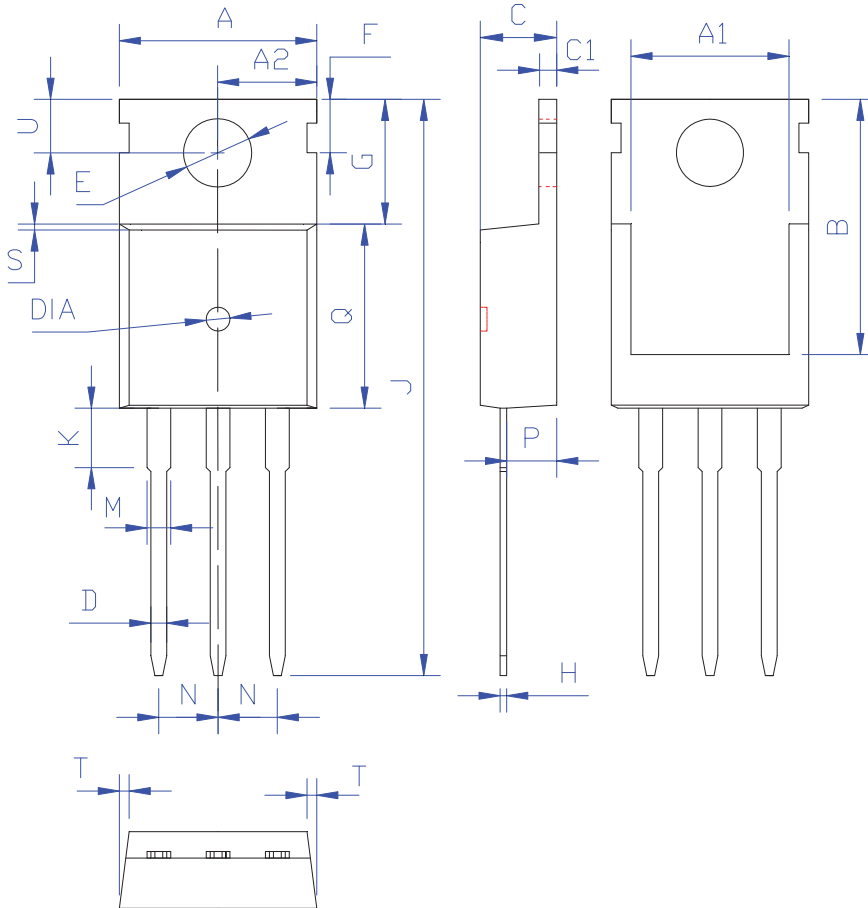

DIM	MILLIMETERS
A	10.00 ± 0.30
A1	8.00 ± 0.30
A2	5.00 ± 0.30
B	13.20 ± 0.40
C	4.50 ± 0.20
C1	1.30 ± 0.20
D	0.80 ± 0.20
E	3.60 ± 0.20
F	3.00 ± 0.30
G	6.60 ± 0.40
H	0.50 ± 0.20
J	28.88 ± 0.50
K	3.00 ± 0.30
M	1.30 ± 0.30
N	Typical 2.54
P	2.40 ± 0.40
Q	9.20 ± 0.40
S	0.25 ± 0.15
T	0.25 ± 0.15
U	2.80 ± 0.30
DIA	宽 1.50 ± 0.10 深 0.50 MAX

(Unit: mm)

外形尺寸:

Package Dimension:

TO-220F

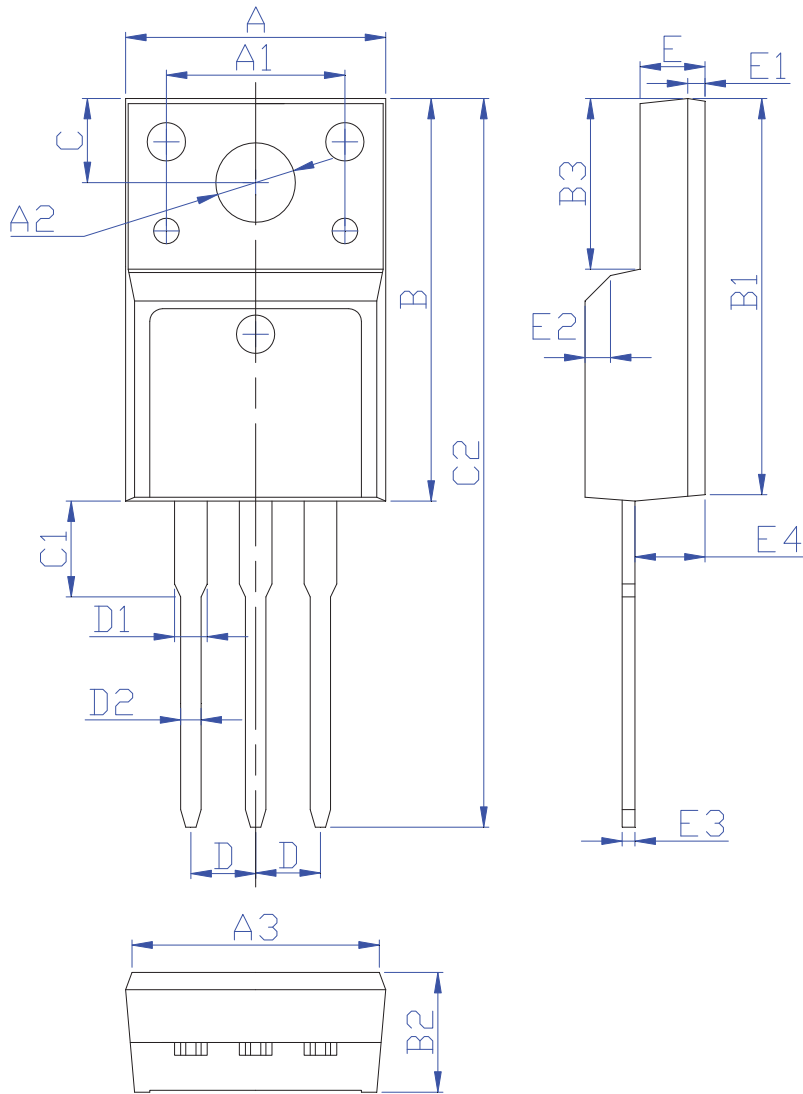

DIM	MILLIMETERS
A	10.16±0.30
A1	7.00±0.20
A2	3.12±0.20
A3	9.70±0.30
B	15.90±0.50
B1	15.60±0.50
B2	4.70±0.30
B3	6.70±0.30
C	3.30±0.25
C1	3.25±0.30
C2	28.70±0.50
D	Typical 2.54
D1	1.47 (MAX)
D2	0.80±0.20
E	2.55±0.25
E1	0.70±0.25
E2	1.0×45°
E3	0.50±0.20
E4	2.75±0.30

(Unit:mm)

X-ON Electronics

Largest Supplier of Electrical and Electronic Components

Click to view similar products for [MOSFET](#) category:

Click to view products by [FeiHong](#) manufacturer:

Other Similar products are found below :

[614233C](#) [648584F](#) [MCH3443-TL-E](#) [MCH6422-TL-E](#) [FDPF9N50NZ](#) [FW216A-TL-2W](#) [FW231A-TL-E](#) [APT5010JVR](#) [NTNS3A92PZT5G](#)
[IRF100S201](#) [JANTX2N5237](#) [2SK2464-TL-E](#) [2SK3818-DL-E](#) [FCA20N60_F109](#) [FDZ595PZ](#) [STD6600NT4G](#) [FSS804-TL-E](#) [2SJ277-DL-E](#)
[2SK1691-DL-E](#) [2SK2545\(Q,T\)](#) [D2294UK](#) [405094E](#) [423220D](#) [MCH6646-TL-E](#) [TPCC8103,L1Q\(CM](#) [367-8430-0972-503](#) [VN1206L](#)
[424134F](#) [026935X](#) [051075F](#) [SBVS138LT1G](#) [614234A](#) [715780A](#) [NTNS3166NZT5G](#) [751625C](#) [873612G](#) [IRF7380TRHR](#)
[IPS70R2K0CEAKMA1](#) [RJK60S3DPP-E0#T2](#) [RJK60S5DPK-M0#T0](#) [APT5010JVFR](#) [APT12031JFLL](#) [APT12040JVR](#) [DMN3404LQ-7](#)
[NTE6400](#) [JANTX2N6796U](#) [JANTX2N6784U](#) [JANTXV2N5416U4](#) [SQM110N05-06L-GE3](#) [SIHF35N60E-GE3](#)