



N 沟道增强型场效应晶体管

N-CHANNEL MOSFET

FHF2N60E/FHP2N60E/FHU2N60E/FHD2N60E

主要参数 MAIN CHARACTERISTICS

ID	2A
VDSS	600V
Rdson-typ ( @Vgs=10V)	4.0Ω
Qg-typ	8.0nC

产品特性 FEATURES

低栅极电荷	Low gate charge
低 Crss (典型值 6pF)	Low Crss (typical 6pF)
开关速度快	Fast switching
100%经过雪崩测试	100% avalanche tested
高抗 dv/dt 能力	Improved dv/dt capability
RoHS 产品	RoHS product

用途 APPLICATIONS

高频开关电源	High efficiency switch mode power supplies
电子镇流器	Electronic ballast
LED 电源	LED power supply

等效电路 Equivalent Circuit

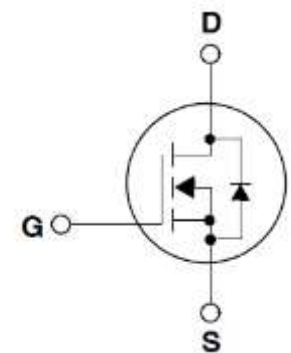

封装形式 Package

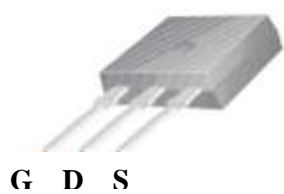

TO-251  
FHU 系列

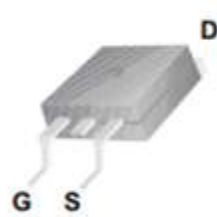

TO-252  
FHD 系列



TO-220  
FHP 系列

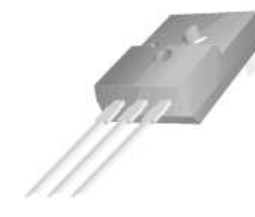

TO-220F  
FHF 系列

绝对最大额定值 ABSOLUTE RATINGS (Tc=25°C)

项目 Parameter	符号 Symbol	数值 Value				单位 Unit
		FHU2N60E	FHD2N60E	FHP2N60E	FHF2N60E	
最高漏极-源极直流电压 Drain-Source Voltage	V <sub>DS</sub>	600				V
连续漏极电流* Drain Current -continuous *	I <sub>D</sub> (T <sub>C</sub> =25°C)	2				A
	I <sub>D</sub> (T <sub>C</sub> =100°C)	1.2				A
最大脉冲漏极电流 (注 1) Drain Current – pulse (note 1)	I <sub>DM</sub>	8				A
最高栅源电压 Gate-Source Voltage	V <sub>GS</sub>	±30				V
单脉冲雪崩能量 (注 2) Single Pulsed Avalanche Energy (note 2)	E <sub>AS</sub>	120				mJ
雪崩电流 (注 1) Avalanche Current (note 1)	I <sub>AR</sub>	1.1				A
重复雪崩能量 (注 1) Repetitive Avalanche Current (note 1)	E <sub>AR</sub>	6.4				mJ
二极管反向恢复最大电压变化速率 (注 3) Peak Diode Recovery dv/dt (note 3)	dv/dt	5.0				V/ns
耗散功率 Power Dissipation	P <sub>D</sub> (T <sub>C</sub> =25°C)	35		54	27	W
	-Derate above 25°C	0.27		0.43	0.22	W/°C
最高结温及存储温度 Operating and Storage Temperature Range	T <sub>J</sub> , T <sub>STG</sub>	150, -55 to 150				°C
引线最高焊接温度 Maximum Lead Temperature for Soldering Purposes	T <sub>L</sub>	300				°C

\*漏极电流由最高结温限制

\*Drain current limited by maximum junction temperature

## 电特性 ELECTRICAL CHARACTERISTICS

项目 Parameter	符号 Symbol	测试条件 Tests conditions	最小 Min	典型 Typ	最大 Max	单位 Units
<b>关态特性 Off –Characteristics</b>						
漏-源击穿电压 Drain-Source Voltage	BV <sub>DSS</sub>	I <sub>D</sub> =250μA, V <sub>GS</sub> =0V	600	-	-	V
击穿电压温度特性 Breakdown Voltage Temperature Coefficient	ΔBV <sub>DSS</sub> /ΔT <sub>J</sub>	I <sub>D</sub> =250μA, referenced to 25°C	-	0.6	-	V/°C
零栅压下漏极漏电流 Zero Gate Voltage Drain Current	I <sub>DSS</sub>	V <sub>DS</sub> =600V, V <sub>GS</sub> =0V, T <sub>C</sub> =25°C	-	-	1	μA
		V <sub>DS</sub> =480V, T <sub>C</sub> =125°C	-	-	100	μA
栅极体漏电流 Gate-body leakage current	I <sub>GSS</sub> (F/R)	V <sub>DS</sub> =0V, V <sub>GS</sub> =±30V	-	-	±100	μA
<b>通态特性 On-Characteristics</b>						
阈值电压 Gate Threshold Voltage	V <sub>GS(th)</sub>	V <sub>DS</sub> = V <sub>GS</sub> , I <sub>D</sub> =250μA	2.0	-	4.0	V
静态导通电阻 Static Drain-Source On-Resistance	R <sub>DS(ON)</sub>	V <sub>GS</sub> =10V , I <sub>D</sub> =1A	-	4.0	5.0	Ω
正向跨导 Forward Transconductance	g <sub>fs</sub>	V <sub>DS</sub> = 15V, I <sub>D</sub> =1A (note 4)	2	-	-	S
<b>动态特性 Dynamic Characteristics</b>						
输入电容 Input capacitance	C <sub>iss</sub>	V <sub>DS</sub> =25V, V <sub>GS</sub> =0V, f=1.0MHz	-	290	-	pF
输出电容 Output capacitance	C <sub>oss</sub>		-	31	-	
反向传输电容 Reverse transfer capacitance	C <sub>rss</sub>		-	6	-	
<b>开关特性 Switching Characteristics</b>						
延迟时间 Turn-On delay time	t <sub>d(on)</sub>	V <sub>DS</sub> =300V, I <sub>D</sub> =2A, R <sub>G</sub> =9.1Ω V <sub>GS</sub> =10V (note 4, 5)	-	8	-	ns
上升时间 Turn-On rise time	t <sub>r</sub>		-	6	-	ns
延迟时间 Turn-Off delay time	t <sub>d(off)</sub>		-	30	-	ns
下降时间 Turn-Off Fall time	t <sub>f</sub>		-	11	-	ns
栅极电荷总量 Total Gate Charge	Q <sub>g</sub>	V <sub>DS</sub> =300V , I <sub>D</sub> =2A , V <sub>GS</sub> =10V (note 4, 5)	-	9	-	nC
栅-源电荷 Gate-Source charge	Q <sub>gs</sub>		-	1.5	-	nC
栅-漏电荷 Gate-Drain charge	Q <sub>gd</sub>		-	4	-	nC
<b>漏-源二极管特性及最大额定值 Drain-Source Diode Characteristics and Maximum Ratings</b>						
正向最大连续电流 Maximum Continuous Drain-Source Diode Forward Current		I <sub>S</sub>	-	-	2	A
正向最大脉冲电流 Maximum Pulsed Drain-Source Diode Forward Current		I <sub>SM</sub>	-	-	8	A
正向压降 Drain-Source Diode Forward Voltage	V <sub>SD</sub>	V <sub>GS</sub> =0V, I <sub>S</sub> =2A	-	-	1.5	V
反向恢复时间 Reverse recovery time	t <sub>rr</sub>	V <sub>GS</sub> =0V, I <sub>S</sub> =2A ,dI <sub>F</sub> /dt=100A/μs (note 4)	-	425	-	ns
反向恢复电荷 Reverse recovery charge	Q <sub>rr</sub>		-	1140	-	nC

## 热特性 THERMAL CHARACTERISTIC

项目 Parameter	符号 Symbol	FHP2N60E	FHF2N60E	FHU2N60E	FHD2N60E	单位 Unit
结到管壳的热阻 Thermal Resistance, Junction to Case	Rth(j-c)	2.32	5.5	2.98		°C/W
结到环境的热阻 Thermal Resistance, Junction to Ambient	Rth(j-A)	62.5	100	50		°C/W

注释:

Notes:

- 1: 脉冲宽度由最高结温限制
- 2: L=56mH, IAS=2A, VDD=48V, RG=25 Ω, 起始结温 TJ=25°C
- 3: ISD ≤2A, di/dt ≤100A/μs, VDD≤BVDSS, 起始结温 TJ=25°C
- 4: 脉冲测试: 脉冲宽度 ≤300μs, 占空比≤2%
- 5: 基本与工作温度无关

- 1: Pulse width limited by maximum junction temperature
- 2: L=56mH, ID=2A, Start TJ=25°C;
- 3: ISD ≤2A, di/dt ≤100A/μs, VDD≤BV<sub>DSS</sub>, Starting TJ=25°C
- 4: Pulse Test: Pulse Width ≤300μs, Duty Cycle≤2%
- 5: Essentially independent of operating temperatur

# 特性曲线

## (ELECTRICAL CHARACTERISTICS (curves))

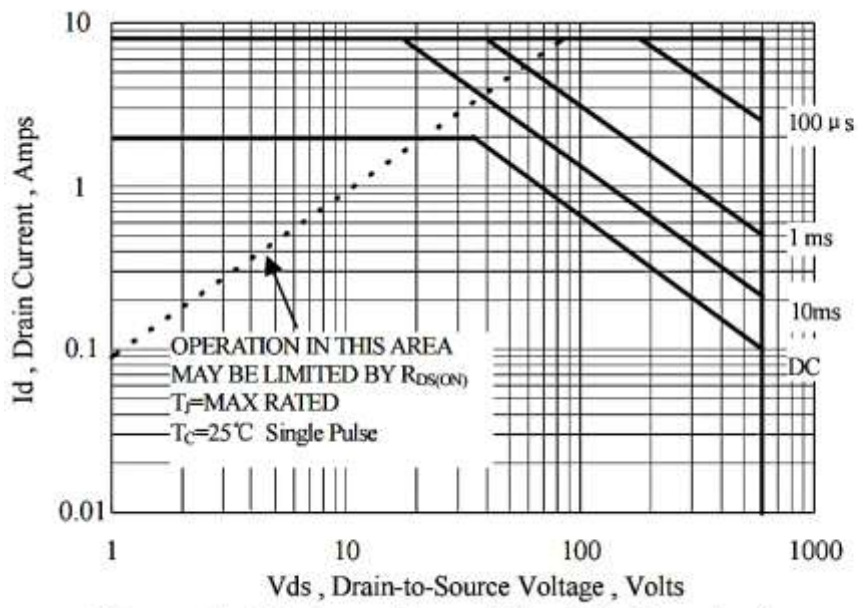

Figure 1 Maximum Forward Bias Safe Operating Area

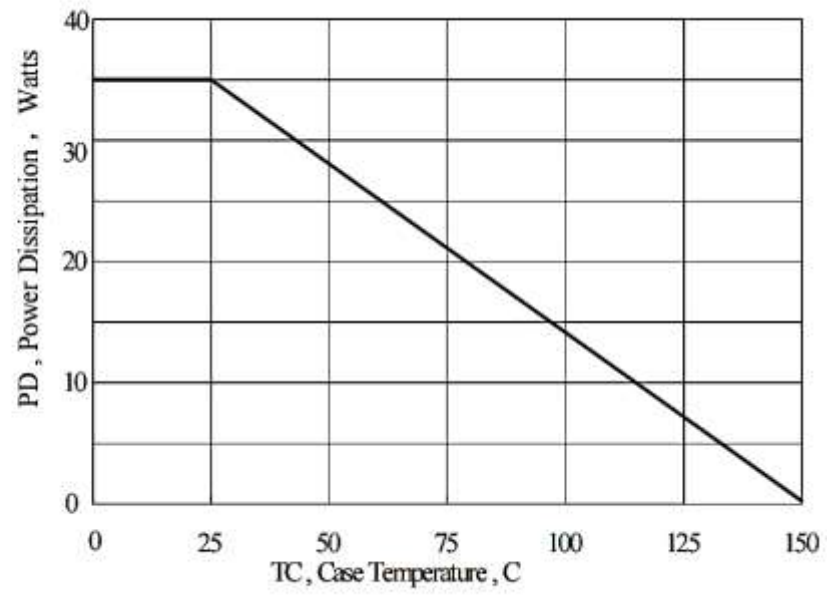

Figure 2 Maximum Power Dissipation vs Case Temperature

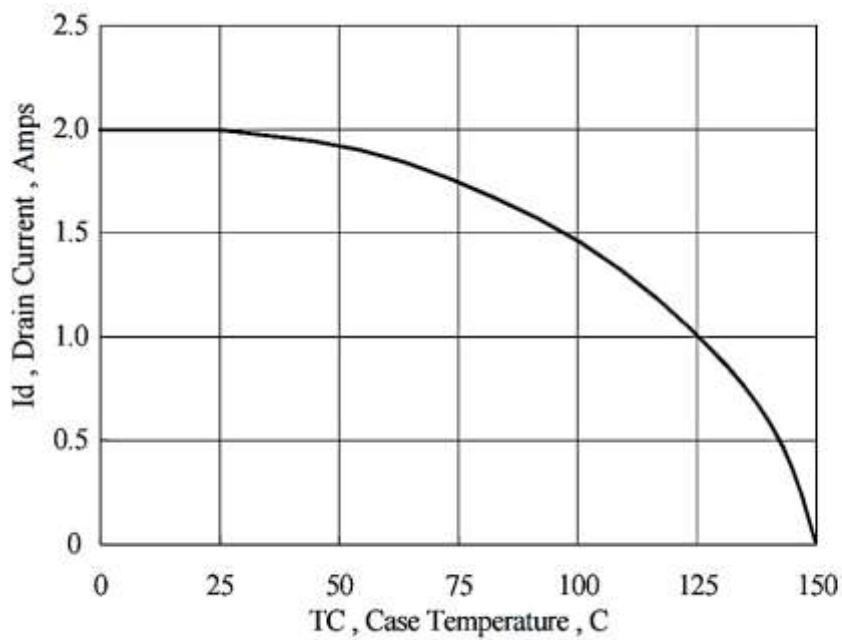

Figure 3 Maximum Continuous Drain Current vs Case Temperature

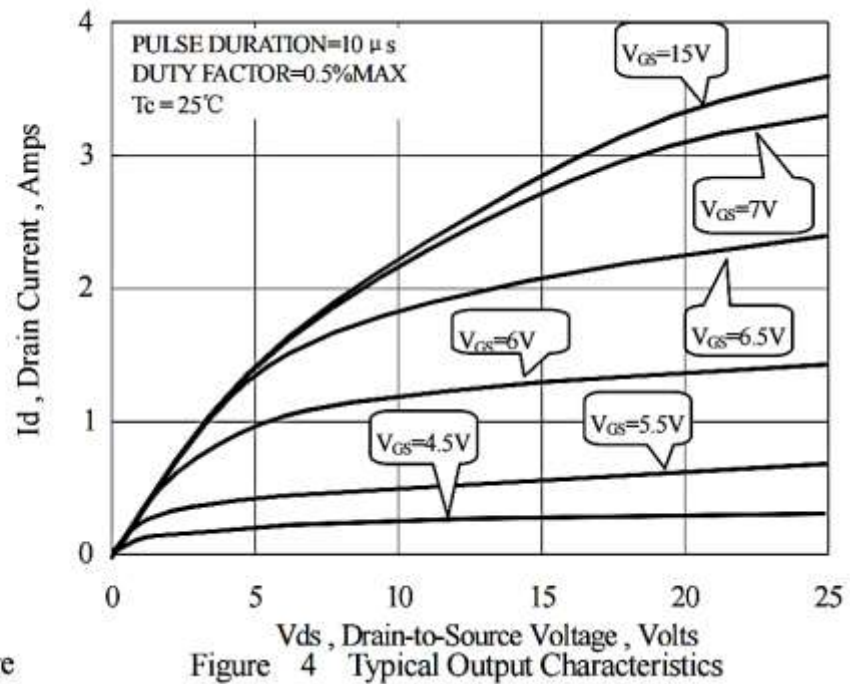

Figure 4 Typical Output Characteristics

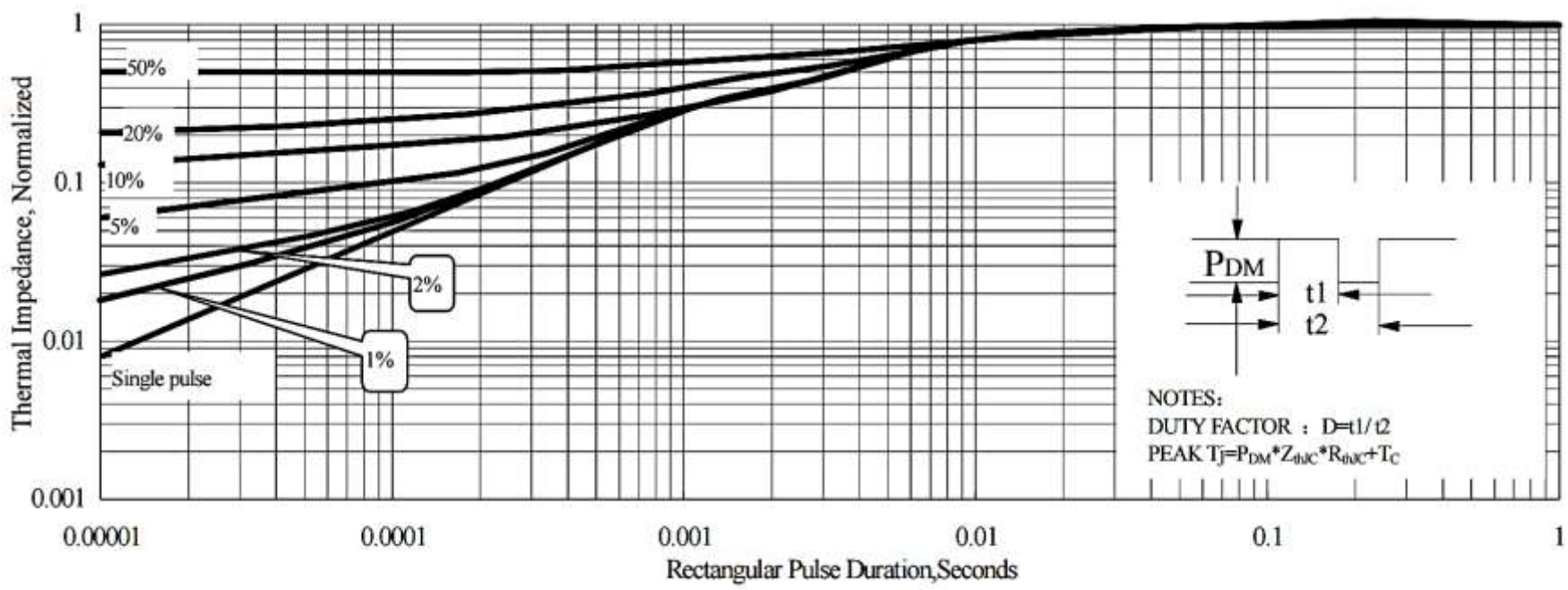

Figure 5 Maximum Effective Thermal Impedance , Junction to Case



# 特性曲线 (ELECTRICAL CHARACTERISTICS (curves))

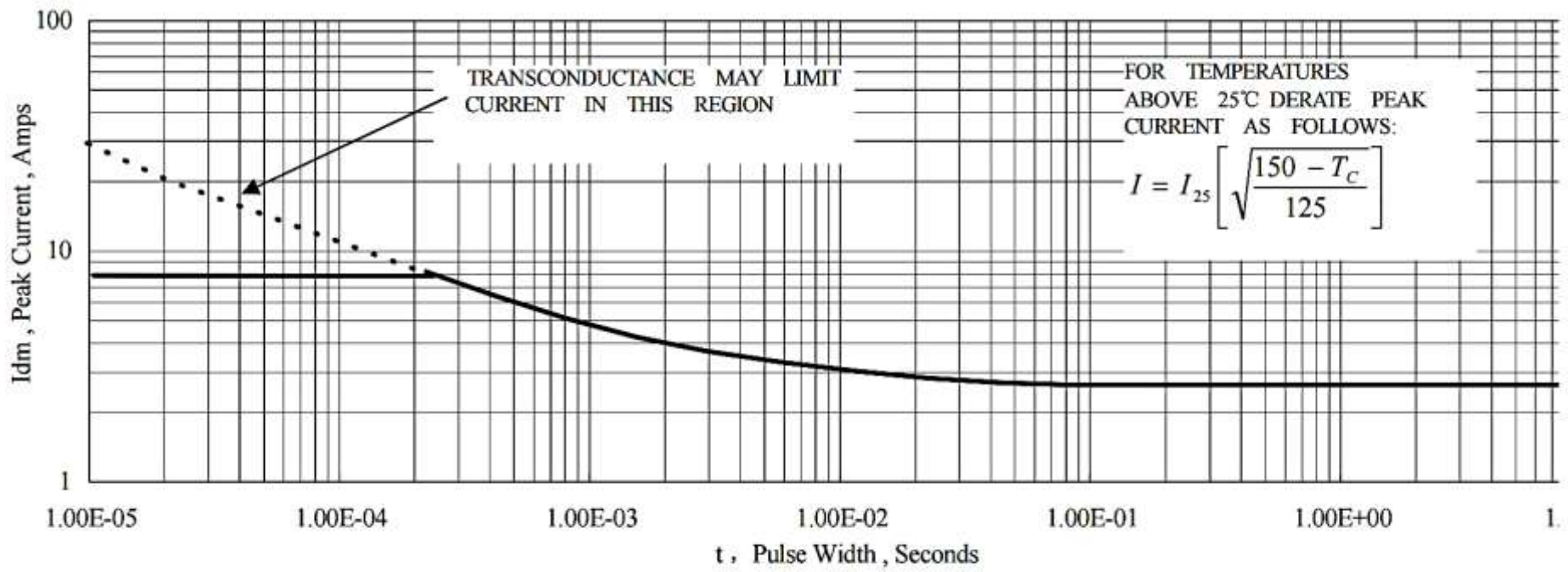

Figure 6 Maximum Peak Current Capability

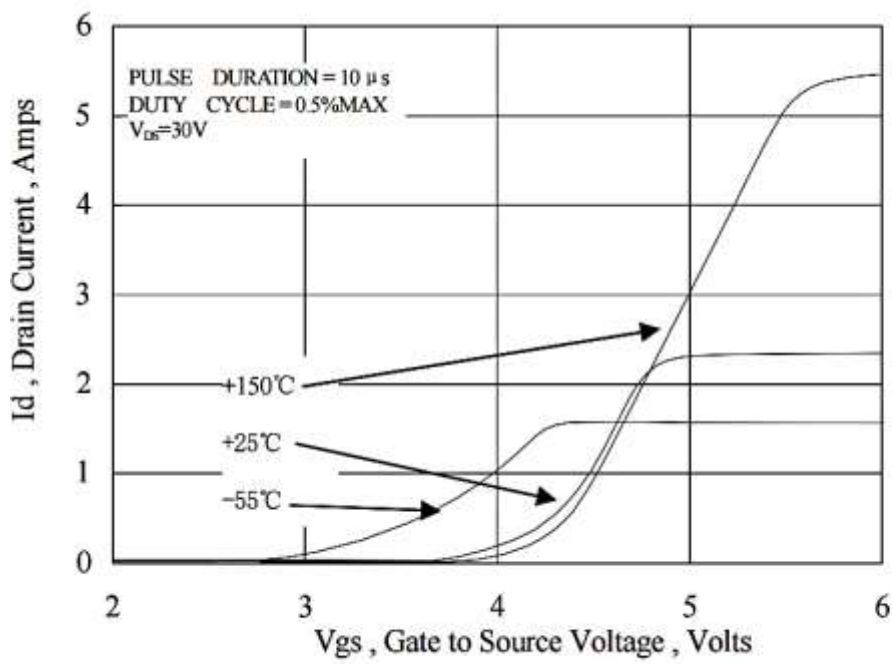

Figure 7 Typical Transfer Characteristics

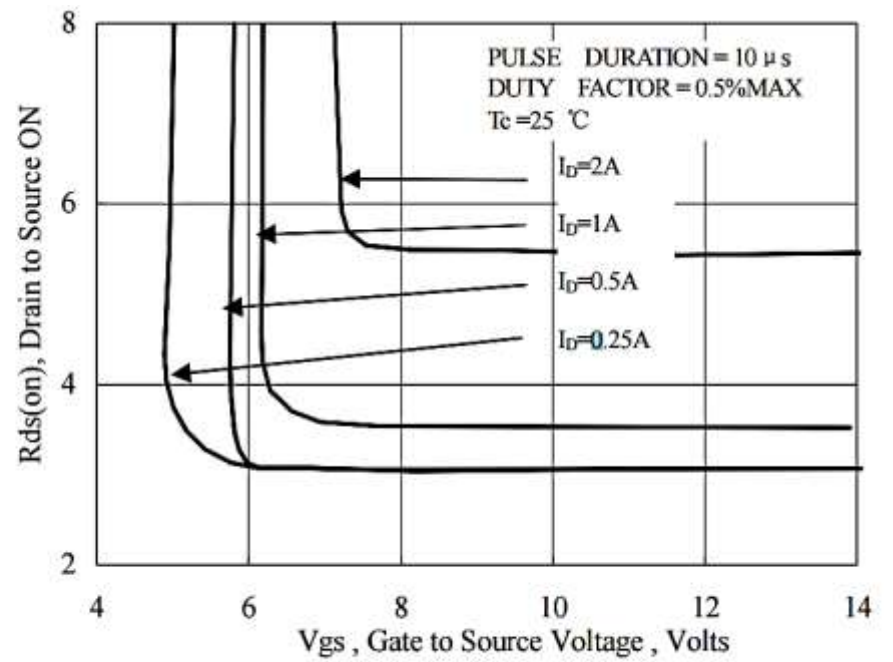

Figure 8 Typical Drain to Source ON Resistance vs Gate Voltage and Drain Current

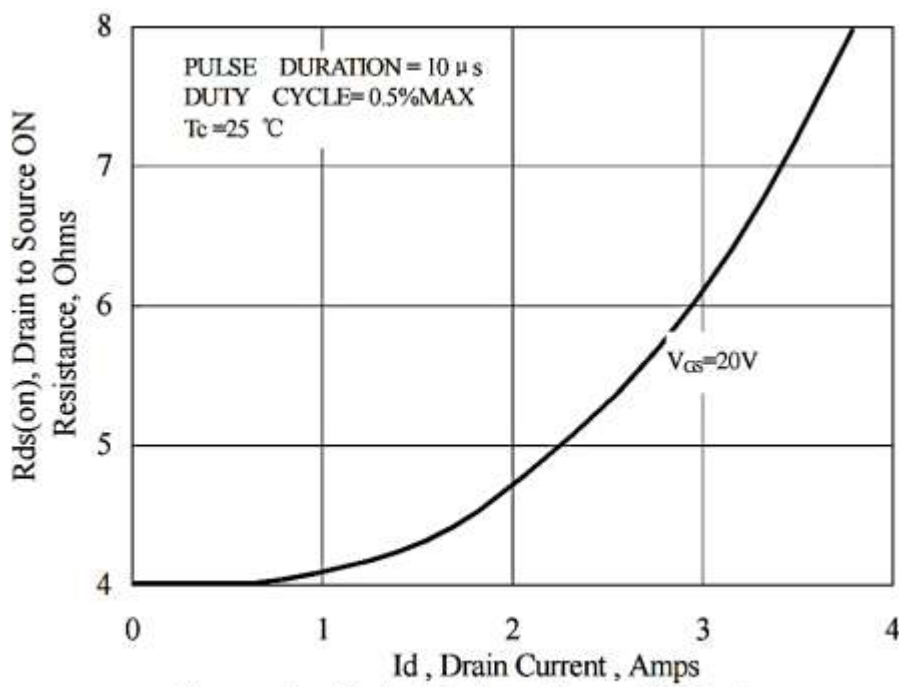

Figure 9 Typical Drain to Source ON Resistance vs Drain Current

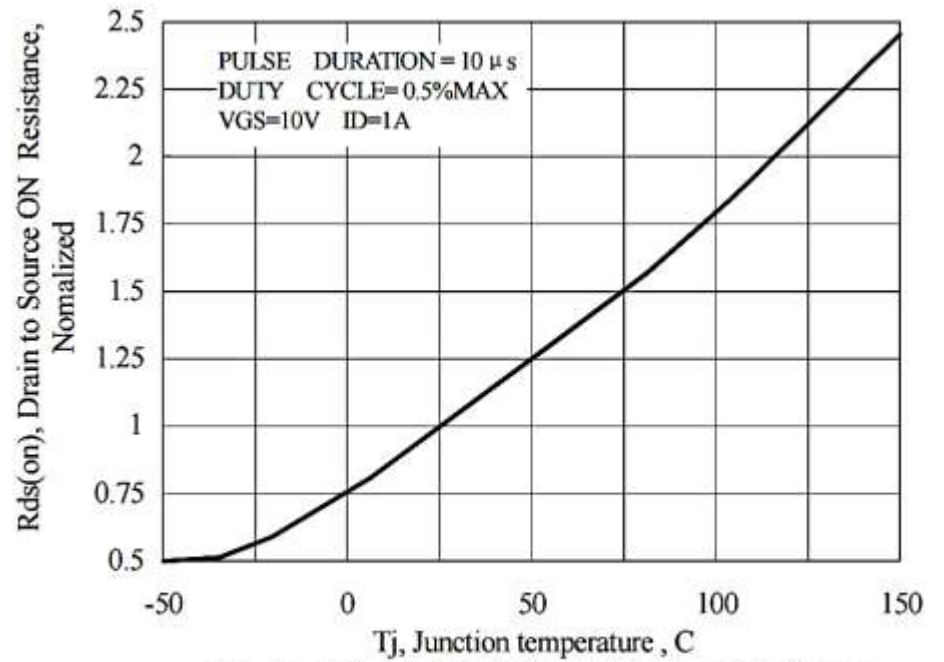

Figure 10 Typical Drain to Source ON Resistance vs Junction Temperature

# 特性曲线 (ELECTRICAL CHARACTERISTICS (curves))

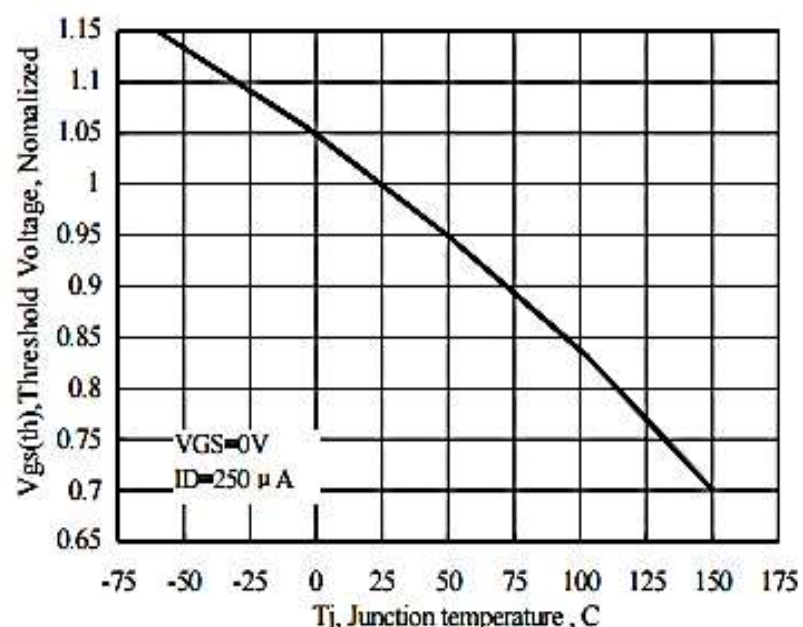

Figure 11 Typical Theshold Voltage vs Junction Temperature

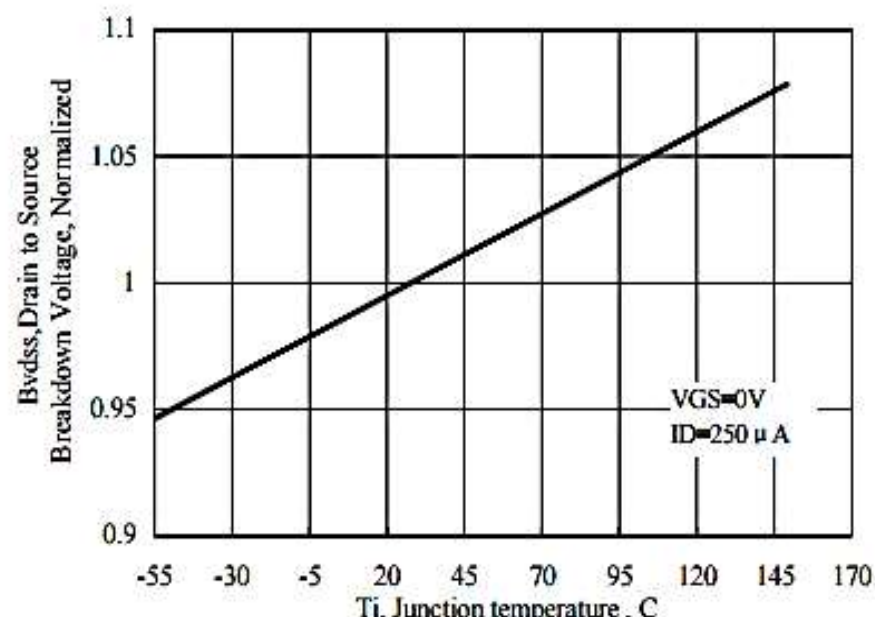

Figure 12 Typical Breakdown Voltage vs Junction Temperature

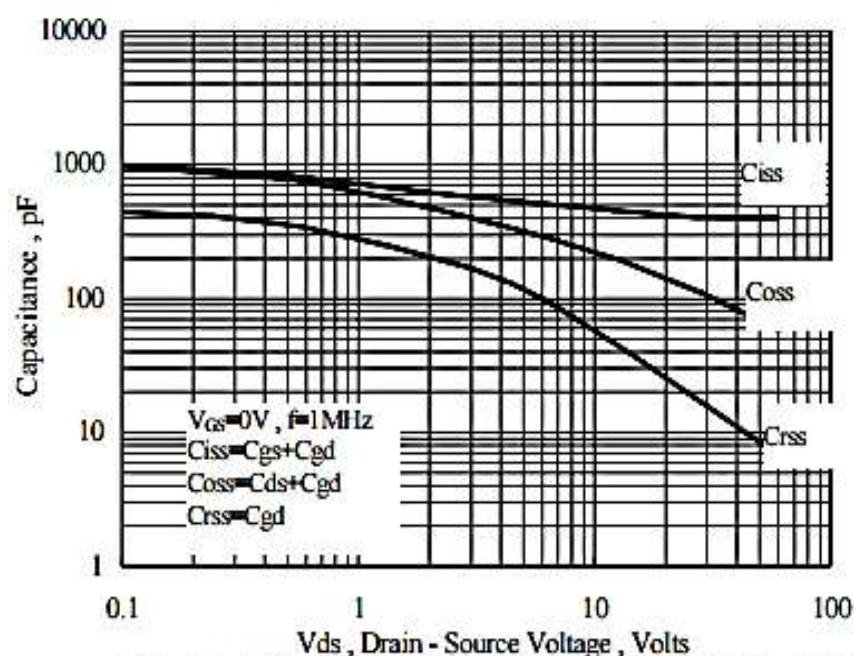

Figure 13 Typical Capacitance vs Drain to Source Voltage

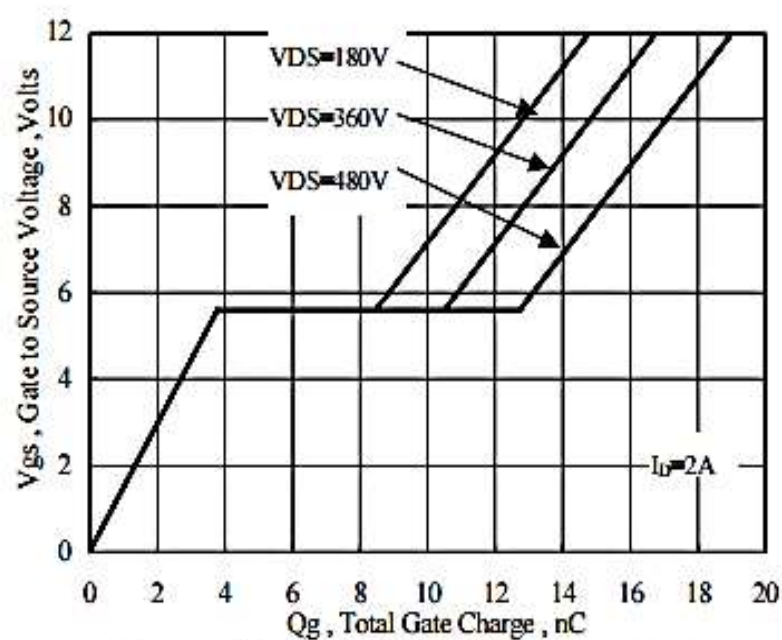

Figure 14 Typical Gate Charge vs Gate to Source Voltage

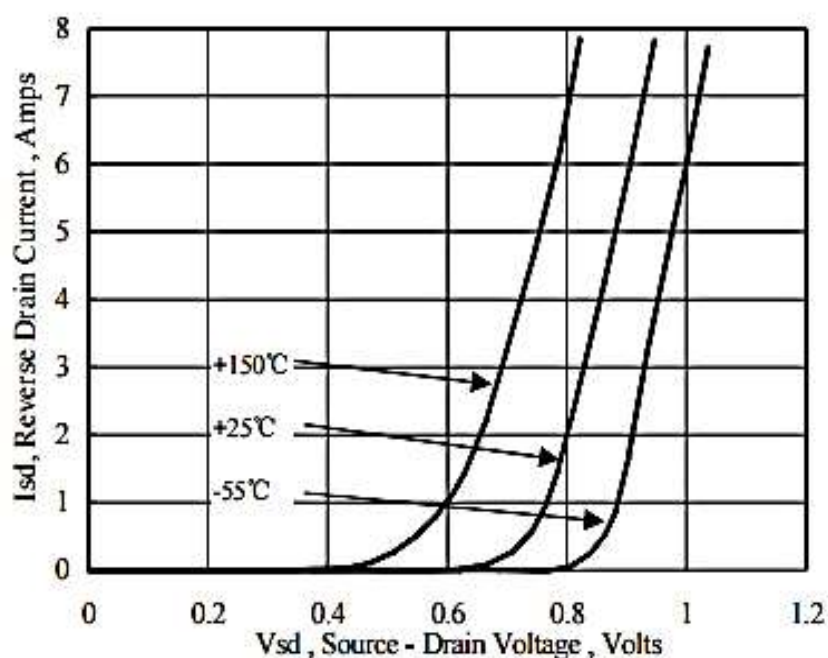

Figure 15 Typical Body Diode Transfer Characteristics

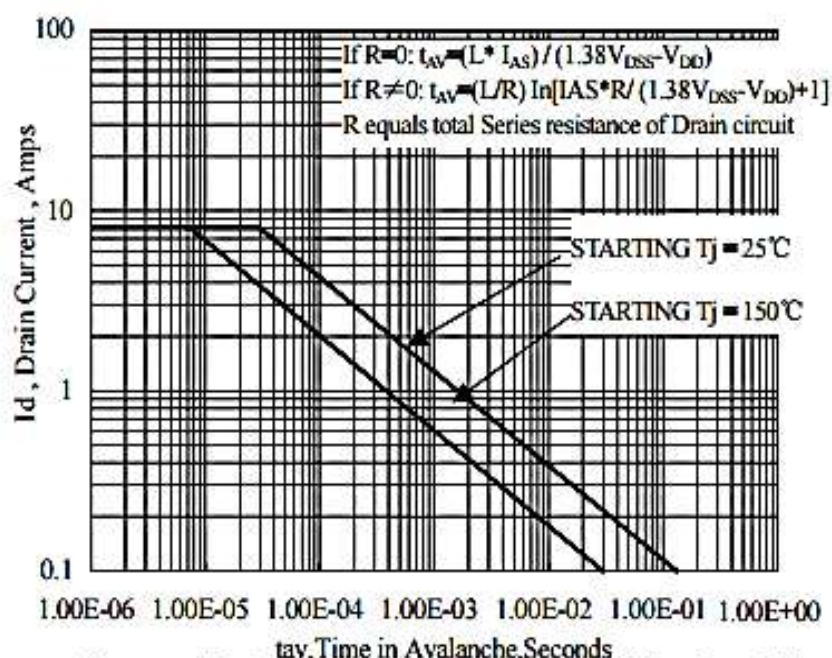
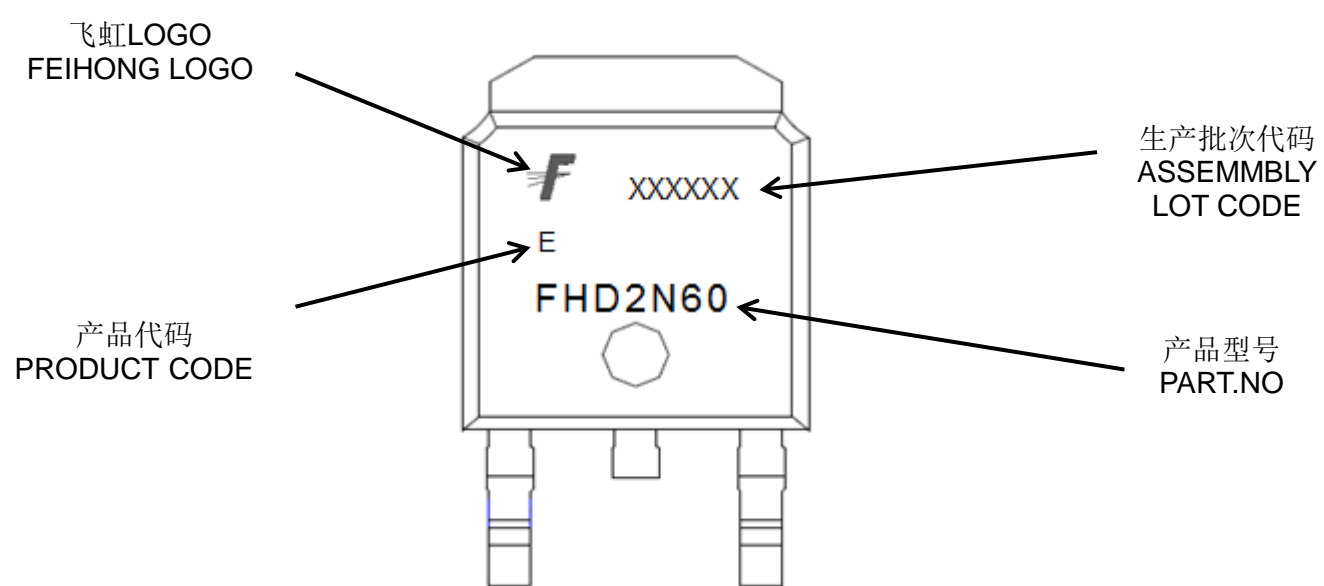
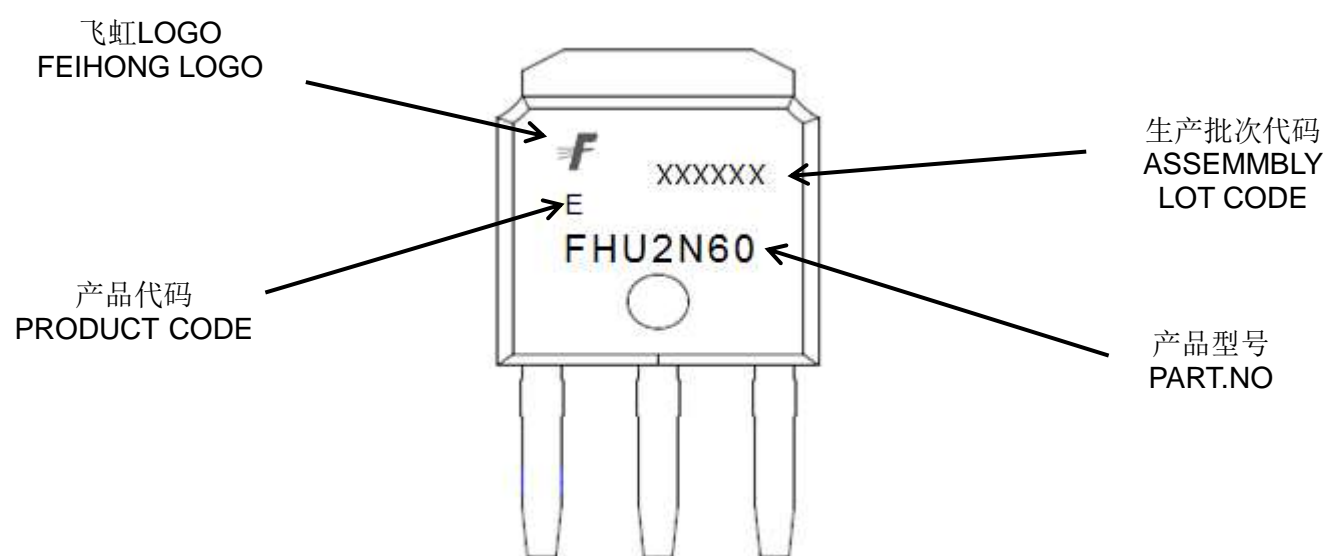

Figure 16 Unclamped Inductive Switching Capability



印记 Marking:



飞虹LOGO  
FEIHONG LOGO

产品代码  
PRODUCT CODE

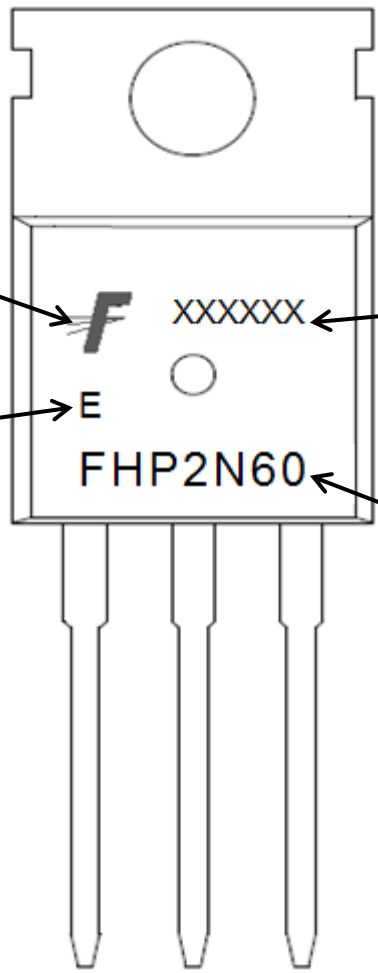

生产批次代码  
ASSEMBLY  
LOT CODE

产品型号  
PART.NO

飞虹LOGO  
FEIHONG LOGO

产品代码  
PRODUCT CODE

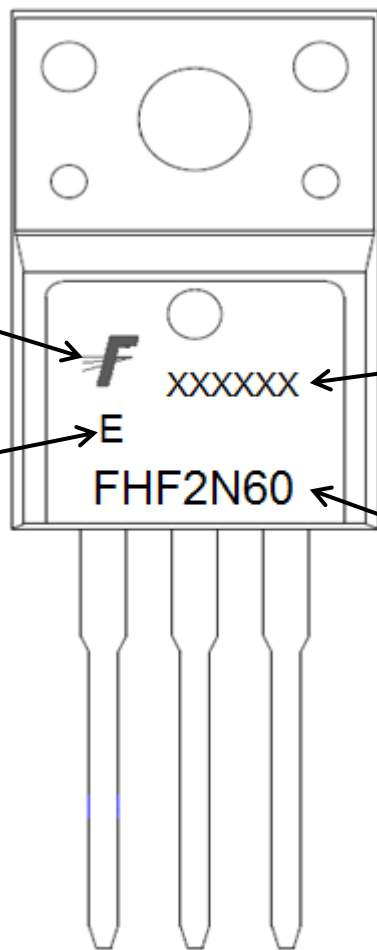

生产批次代码  
ASSEMBLY  
LOT CODE

产品型号  
PART.NO



外形尺寸:  
Package Dimension:

TO-251

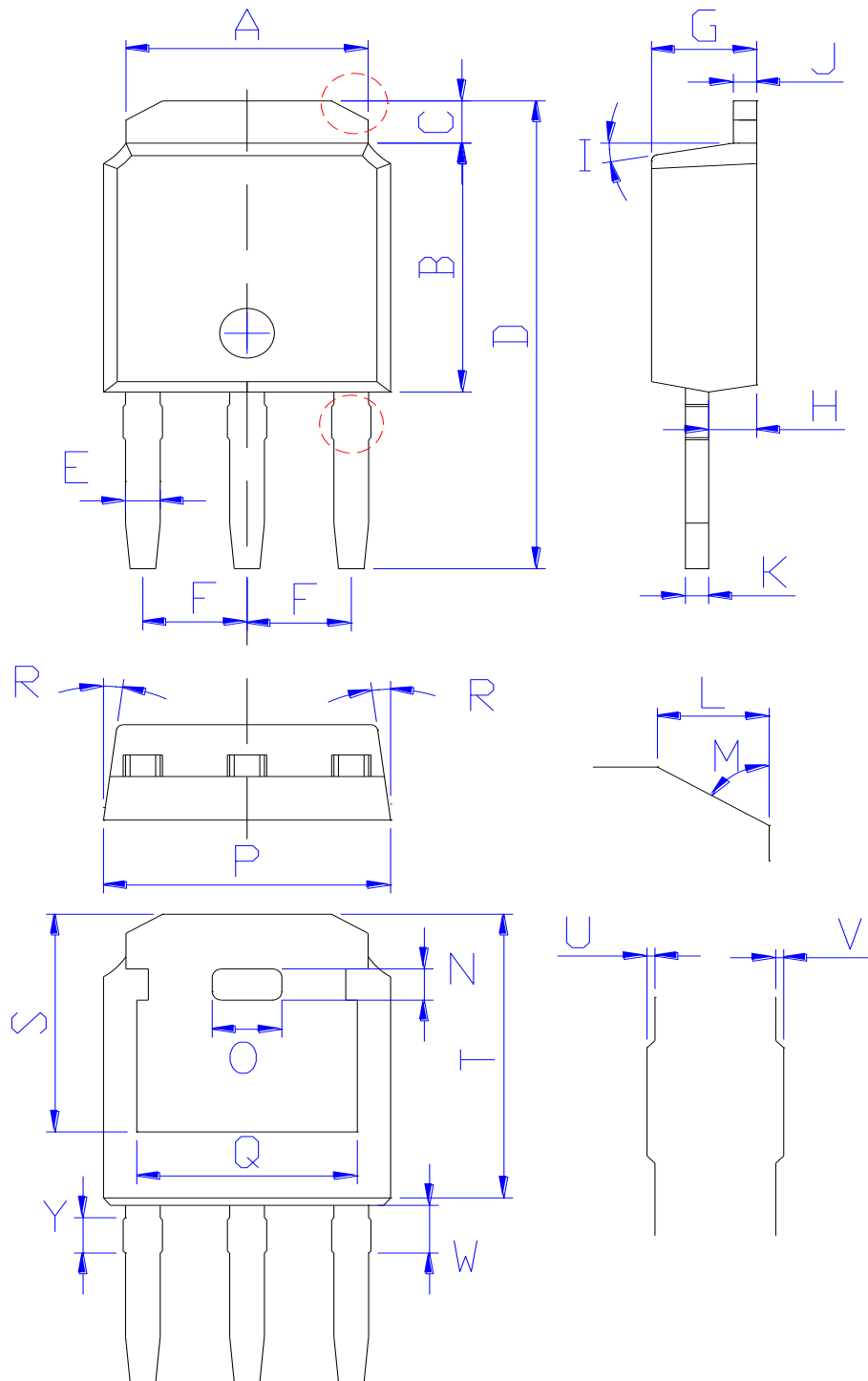

DIM	MILLIMETERS
A	5.34±0.30
B	6.00±0.30
C	1.05±0.30
D	11.31±0.30
E	0.76±0.15
F	2.28±0.15
G	2.30±0.30
H	1.06±0.30
I	(4-10)°
J	0.51±0.15
K	0.52±0.15
L	0.80±0.30
M	60°
N	0.75±0.30
O	1.80±0.30
P	6.60±0.30
Q	4.85±0.30
R	(4-8.5)°
S	5.30±0.30
T	6.90±0.30
U	0.05±0.05
V	0.05±0.05
W	1.15±0.25
Y	0.85±0.25

(Units: mm)

外形尺寸:  
Package Dimension:

TO-252

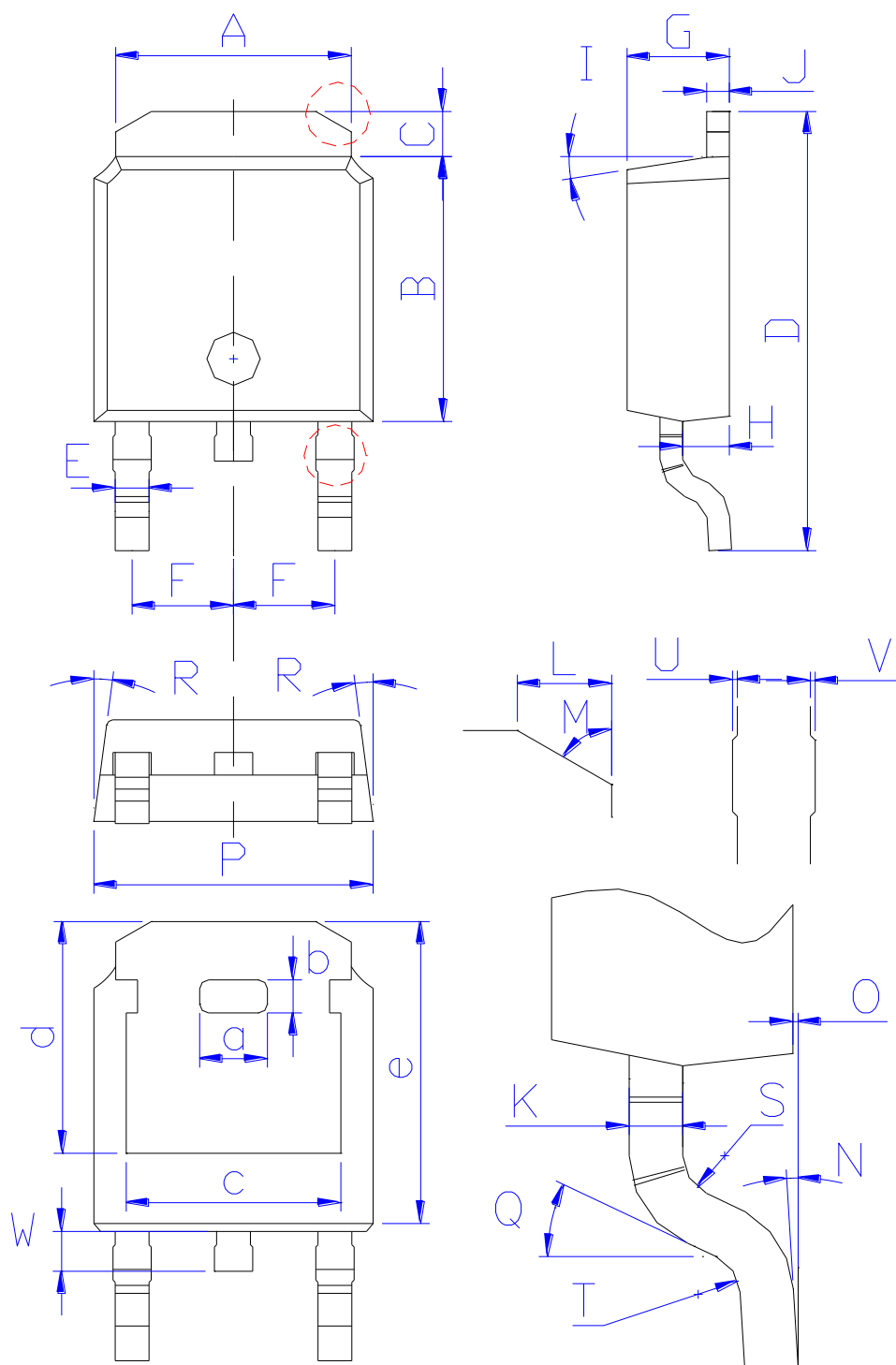

DIM	MILLIMETERS
A	5.34±0.30
B	6.00±0.30
C	1.05±0.30
D	9.95±0.30
E	0.76±0.15
F	2.28±0.15
G	2.30±0.30
H	1.06±0.30
I	(4-10)°
J	0.51±0.15
K	0.52±0.15
L	0.80±0.30
M	60°
N	(0-10)°
O	0.05±0.05
P	6.60±0.30
Q	25°
R	(4-8.5)°
S	R0.40
T	R0.40
U	0.05±0.05
V	0.05±0.05
W	0.90±0.30
a	1.80±0.30
b	0.75±0.30
c	4.85±0.30
d	5.30±0.30
e	6.90±0.30

(Units: mm)

外形尺寸:  
Package Dimension:

TO-220

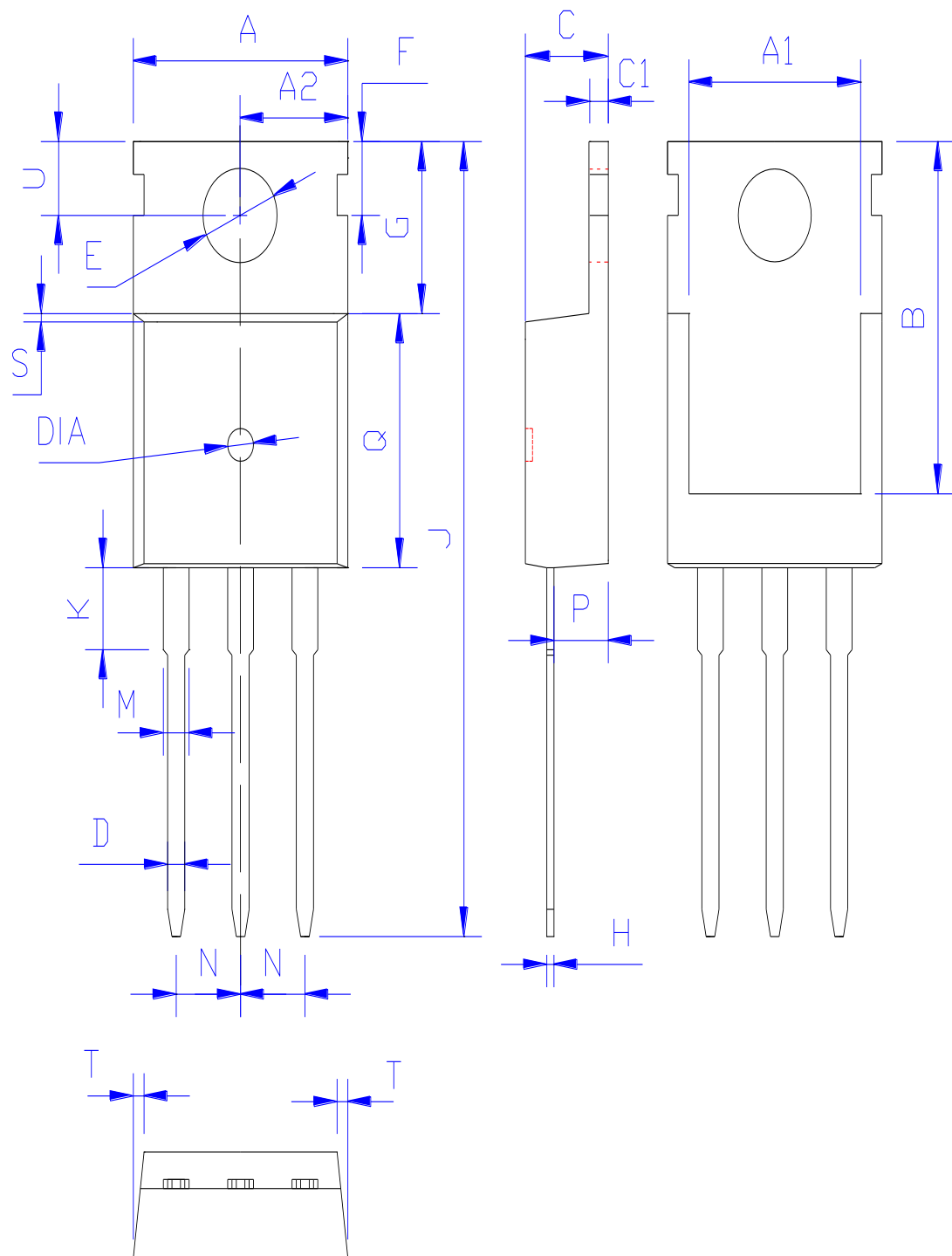

DIM	MILLIMETERS
A	10.00±0.30
A1	8.00±0.30
A2	5.00±0.30
B	13.20±0.40
C	4.50±0.20
C1	1.30±0.20
D	0.80±0.20
E	3.60±0.20
F	3.00±0.30
G	6.60±0.40
H	0.50±0.20
J	28.88±0.50
K	3.00±0.30
M	1.30±0.30
N	Typical 2.54
P	2.40±0.40
Q	9.20±0.40
S	0.25±0.15
T	0.25±0.15
U	2.80±0.30
DIA	宽 1.50±0.10 深 0.50 MAX

(Units: mm)

外形尺寸:  
Package Dimension:

TO-220F

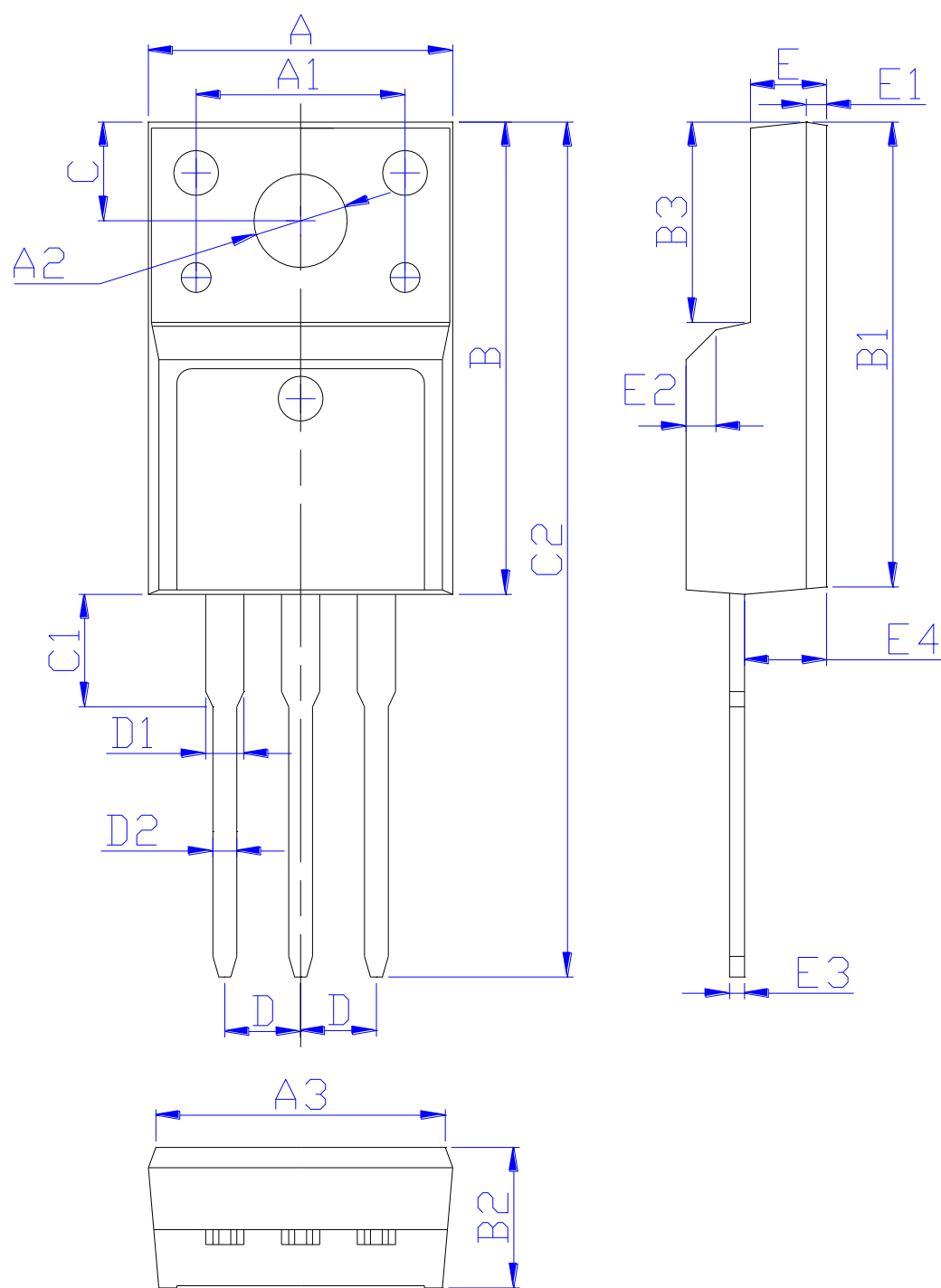

DIM	MILLIMETERS
A	10.16±0.30
A1	7.00±0.20
A2	3.12±0.20
A3	9.70±0.30
B	15.90±0.50
B1	15.60±0.50
B2	4.70±0.30
B3	6.70±0.30
C	3.30±0.25
C1	3.25±0.30
C2	28.70±0.50
D	Typical 2.54
D1	1.47 (MAX)
D2	0.80±0.20
E	2.55±0.25
E1	0.70±0.25
E2	1.0×45°
E3	0.50±0.20
E4	2.75±0.30

(Units: mm)



## X-ON Electronics

Largest Supplier of Electrical and Electronic Components

*Click to view similar products for [MOSFET](#) category:*

*Click to view products by [FeiHong](#) manufacturer:*

Other Similar products are found below :

[614233C](#) [648584F](#) [MCH3443-TL-E](#) [MCH6422-TL-E](#) [FDPF9N50NZ](#) [FW216A-TL-2W](#) [FW231A-TL-E](#) [APT5010JVR](#) [NTNS3A92PZT5G](#)  
[IRF100S201](#) [JANTX2N5237](#) [2SK2464-TL-E](#) [2SK3818-DL-E](#) [FCA20N60\\_F109](#) [FDZ595PZ](#) [STD6600NT4G](#) [FSS804-TL-E](#) [2SJ277-DL-E](#)  
[2SK1691-DL-E](#) [2SK2545\(Q,T\)](#) [D2294UK](#) [405094E](#) [423220D](#) [MCH6646-TL-E](#) [TPCC8103,L1Q\(CM](#) [367-8430-0972-503](#) [VN1206L](#)  
[424134F](#) [026935X](#) [051075F](#) [SBVS138LT1G](#) [614234A](#) [715780A](#) [NTNS3166NZT5G](#) [751625C](#) [873612G](#) [IRF7380TRHR](#)  
[IPS70R2K0CEAKMA1](#) [RJK60S3DPP-E0#T2](#) [RJK60S5DPK-M0#T0](#) [APT5010JVFR](#) [APT12031JFLL](#) [APT12040JVR](#) [DMN3404LQ-7](#)  
[NTE6400](#) [JANTX2N6796U](#) [JANTX2N6784U](#) [JANTXV2N5416U4](#) [SQM110N05-06L-GE3](#) [SIHF35N60E-GE3](#)