



# N 沟道增强型场效应晶体管 N-CHANNEL MOSFET FHU4N65E/FHD4N65E/FHP4N65E/FHF4N65E

## 主要参数 MAIN CHARACTERISTICS

ID	4A
VDSS	650 V
Rdson-typ ( @Vgs=10V)	2.1Ω
Qg-typ	18nC

## 产品特性 FEATURES

低栅极电荷	Low gate charge
低 Crss (典型值 4.5pF)	Low Crss (typical 4.5pF )
开关速度快	Fast switching
100%经过雪崩测试	100% avalanche tested
高抗 dv/dt 能力	Improved dv/dt capability
RoHS 产品	RoHS product

## 用途 APPLICATIONS

高频开关电源	High efficiency switch mode power supplies
--------	--

## 等效电路 Equivalent Circuit

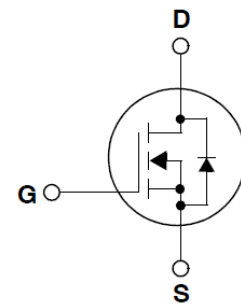

## 封装形式 Package

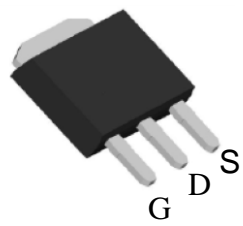

TO-251  
FHU series

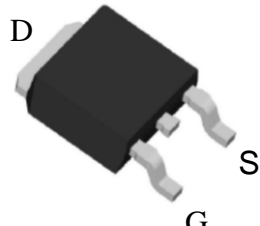

TO-252  
FHD series

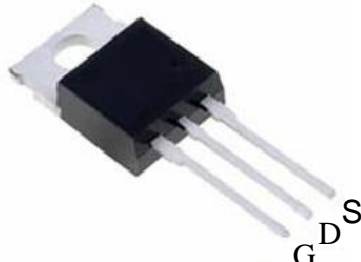

TO-220  
FHP series

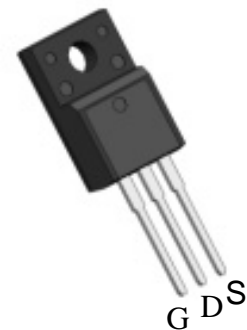

TO-220F  
FHF series

## 绝对最大额定值 ABSOLUTE RATINGS (Tc=25°C)

项目 Parameter	符号 Symbol	数值 Value		单位 Unit
		FHU/D/P4N65F	FHF4N65F	
最高漏极-源极直流电压 Drain-Source Voltage	V <sub>DS</sub>	650		V
连续漏极电流* Drain Current -continuous *	I <sub>D</sub> (T <sub>C</sub> =25°C)	4		A
	I <sub>D</sub> (T <sub>C</sub> =100°C)	3		A
最大脉冲漏极电流 (注 1) Drain Current – pulse (note 1)	I <sub>DM</sub>	16		A
最高栅源电压 Gate-Source Voltage	V <sub>GS</sub>	±30		V
单脉冲雪崩能量 (注 2) Single Pulsed Avalanche Energy (note 2)	E <sub>AS</sub>	54.5		mJ
雪崩电流 (注 1) Avalanche Current (note 1)	I <sub>AS</sub>	3.3		A
重复雪崩能量 (注 1) Repetitive Avalanche Current (note 1)	E <sub>AR</sub>	10		mJ
二极管反向恢复最大电压变化速率 (注 3) Peak Diode Recovery dv/dt (note 3)	dv/dt	5.0		V/ns
耗散功率 Power Dissipation	P <sub>D</sub> (T <sub>C</sub> =25°C)	25	20	W
	-Derate above 25°C	0.43	0.36	W/°C
最高结温及存储温度 Operating and Storage Temperature Range	T <sub>J</sub> , T <sub>STG</sub>	-55~+150		°C
引线最高焊接温度 Maximum Lead Temperature for Soldering Purposes	T <sub>L</sub>	300		°C

\*漏极电流由最高结温限制

\*Drain current limited by maximum junction temperature

## 电特性 ELECTRICAL CHARACTERISTICS

项目 Parameter	符号 Symbol	测试条件 Tests conditions	最小 Min	典型 Typ	最大 Max	单位 Units
关态特性 <b>Off –Characteristics</b>						
漏-源击穿电压 Drain-Source Voltage	BV <sub>DSS</sub>	I <sub>D</sub> =250μA, V <sub>GS</sub> =0V	650	-	-	V
击穿电压温度特性 Breakdown Voltage Temperature Coefficient	ΔBV <sub>DSS</sub> /ΔT <sub>J</sub>	I <sub>D</sub> =250μA, referenced to 25°C	-	0.6	-	V/°C
零栅压下漏极漏电流 Zero Gate Voltage Drain Current	I <sub>DSS</sub>	V <sub>DS</sub> =650V, V <sub>GS</sub> =0V, T <sub>C</sub> =25°C	-	-	1	μA
		V <sub>DS</sub> =520V, T <sub>C</sub> =125°C	-	-	100	μA
栅极体漏电流 Gate-body leakage current	I <sub>GSS</sub> (F/R)	V <sub>DS</sub> =0V, V <sub>GS</sub> =±30V	-	-	±100	nA
通态特性 <b>On-Characteristics</b>						
阈值电压 Gate Threshold Voltage	V <sub>GS(th)</sub>	V <sub>DS</sub> = V <sub>GS</sub> , I <sub>D</sub> =250μA	3	-	4	V
静态导通电阻 Static Drain-Source On-Resistance	R <sub>DS(ON)</sub>	V <sub>GS</sub> =10V , I <sub>D</sub> =2A	-	2.1	2.4	Ω
正向跨导 Forward Transconductance	g <sub>fs</sub>	V <sub>DS</sub> = 25V, I <sub>D</sub> =2A (note 4)	-	4.5	-	S
动态特性 <b>Dynamic Characteristics</b>						
输入电容 Input capacitance	C <sub>iss</sub>	V <sub>DS</sub> =25V, V <sub>GS</sub> =0V, f=1.0MHz	-	545	-	pF
输出电容 Output capacitance	C <sub>oss</sub>		-	53	-	
反向传输电容 Reverse transfer capacitance	C <sub>rss</sub>		-	4.5	-	
开关特性 <b>Switching Characteristics</b>						
延迟时间 Turn-On delay time	t <sub>d(on)</sub>	V <sub>DS</sub> =250V, I <sub>D</sub> =4A, R <sub>G</sub> =25Ω V <sub>GS</sub> =10V (note 4, 5)	-	36	-	ns
上升时间 Turn-On rise time	t <sub>r</sub>		-	13	-	ns
延迟时间 Turn-Off delay time	t <sub>d(off)</sub>		-	80	-	ns
下降时间 Turn-Off Fall time	t <sub>f</sub>		-	24	-	ns
栅极电荷总量 Total Gate Charge	Q <sub>g</sub>	V <sub>DS</sub> =520V , I <sub>D</sub> =4A , V <sub>GS</sub> =10V (note 4, 5)	-	18	-	nC
栅-源电荷 Gate-Source charge	Q <sub>gs</sub>		-	3	-	nC
栅-漏电荷 Gate-Drain charge	Q <sub>gd</sub>		-	12	-	nC
漏-源二极管特性及最大额定值 <b>Drain-Source Diode Characteristics and Maximum Ratings</b>						
正向最大连续电流 Maximum Continuous Drain-Source Diode Forward Current		I <sub>S</sub>	-	-	4	A
正向最大脉冲电流 Maximum Pulsed Drain-Source Diode Forward Current		I <sub>SM</sub>	-	-	16	A
正向压降 Drain-Source Diode Forward Voltage	V <sub>SD</sub>	V <sub>GS</sub> =0V, I <sub>S</sub> =4A	-	0.9	1.3	V
反向恢复时间 Reverse recovery time	t <sub>rr</sub>	V <sub>GS</sub> =0V, I <sub>S</sub> =4A, dI <sub>F</sub> /dt=100A/μs (note 4)	-	550	-	ns
反向恢复电荷 Reverse recovery charge	Q <sub>rr</sub>		-	1.38	-	μC

## 热特性 THERMAL CHARACTERISTIC

项目 Parameter	符号 Symbol	FHU/D/P4N65E	FHF4N65E	单位 Unit
结到管壳的热阻 Thermal Resistance, Junction to Case	Rth(j-c)	5	6.25	°C/W
结到环境的热阻 Thermal Resistance, Junction to Ambient	Rth(j-A)	60	62.5	°C/W

注释:

- 1: 脉冲宽度由最高结温限制
- 2: L=10mH, IAS=3.3A, VDD=50V, RG=25 Ω, 起始结温 TJ=25°C
- 3: ISD ≤4A, di/dt ≤100A/μs, VDD≤BVDS, 起始结温 TJ=25°C
- 4: 脉冲测试: 脉冲宽度 ≤300μs, 占空比≤2%
- 5: 基本与工作温度无关

Notes:

- 1: Pulse width limited by maximum junction temperature
- 2: L=10mH, IAS=3.3A, VDD=50V, RG=25 Ω, Starting TJ=25°C
- 3: ISD ≤4A, di/dt ≤100A/μs, VDD≤BVDS, Starting TJ=25°C
- 4: Pulse Test: Pulse Width ≤300μs, Duty Cycle≤2%
- 5: Essentially independent of operating temperatur

## 特性曲线 Typical Characteristics

Figure 1. Output Characteristics ( $T_J = 25^\circ\text{C}$ )

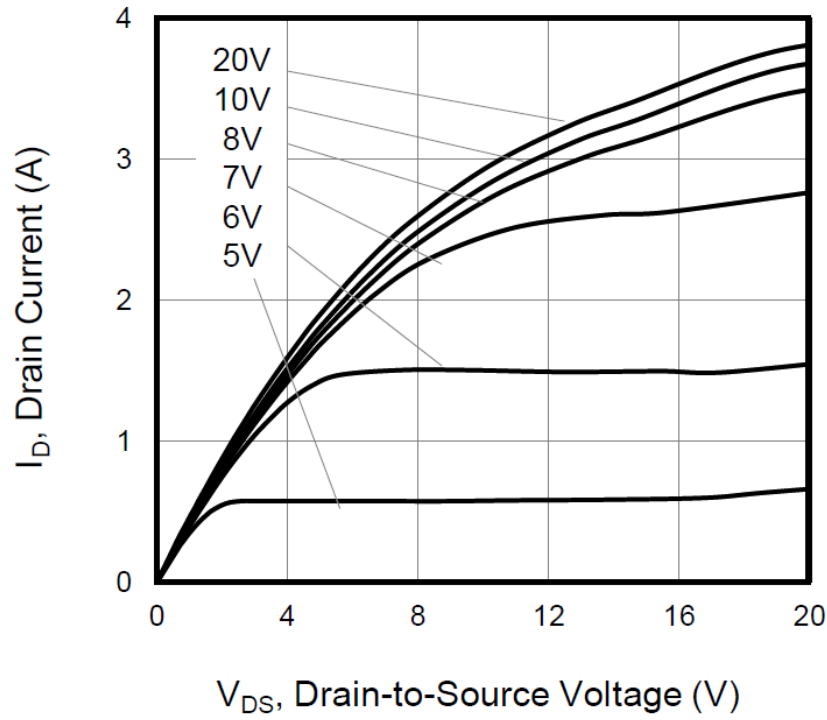

Figure 2. Body Diode Forward Voltage

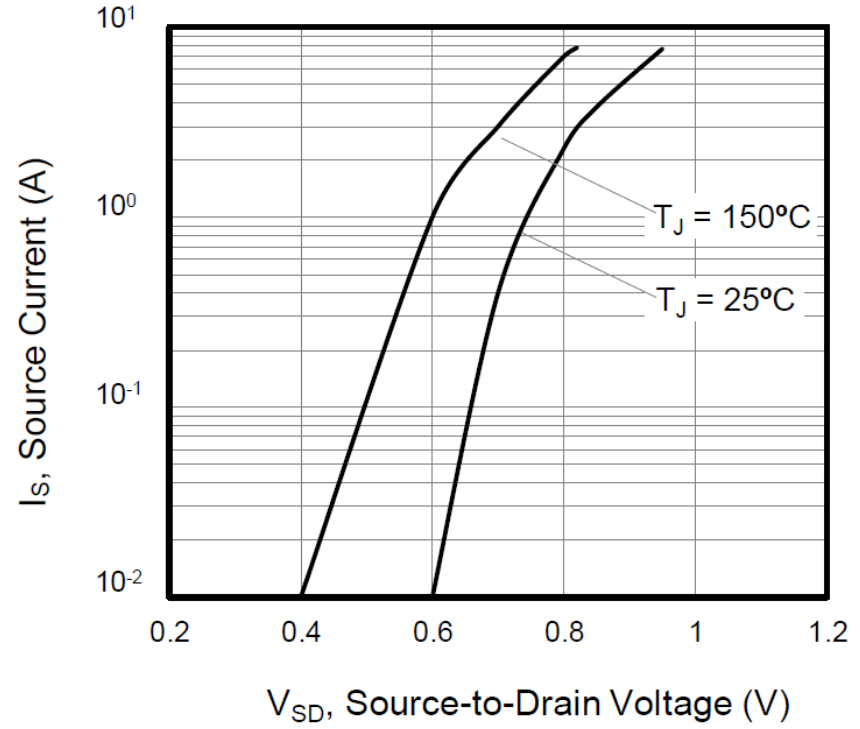

Figure 3. Drain Current vs. Temperature

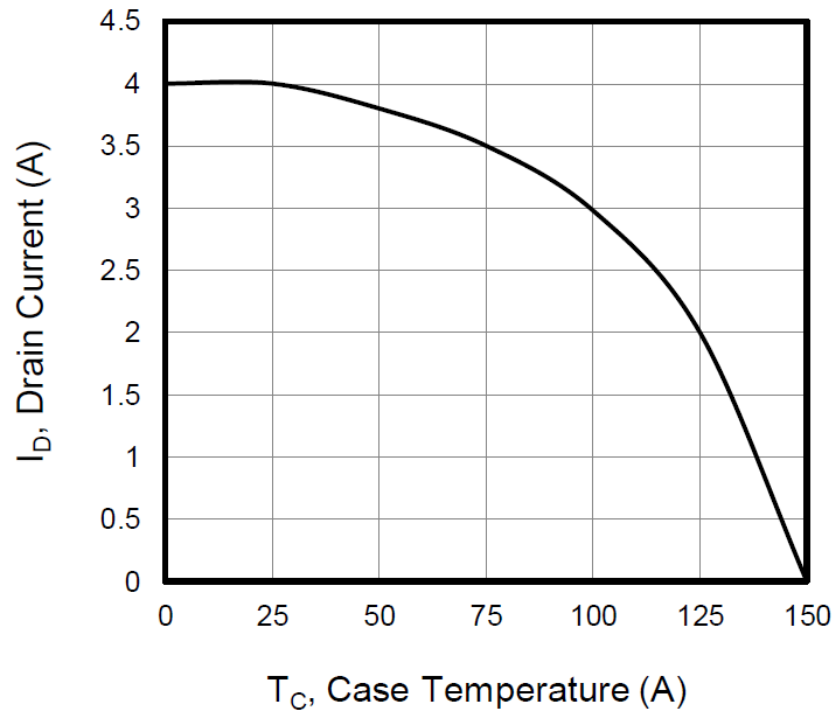

Figure 4. Power Dissipation vs. Temperature

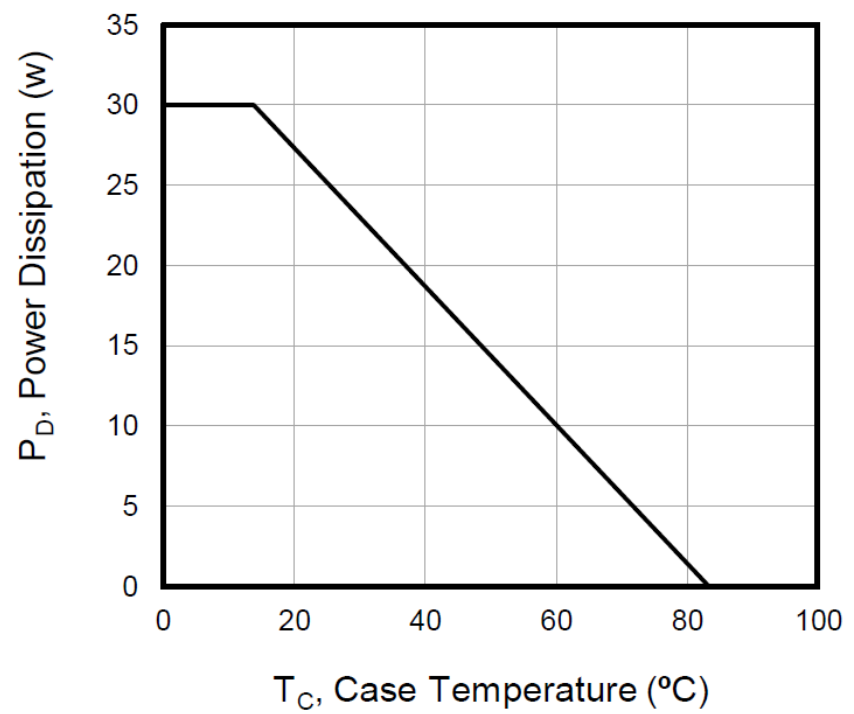

Figure 5. Transfer Characteristics

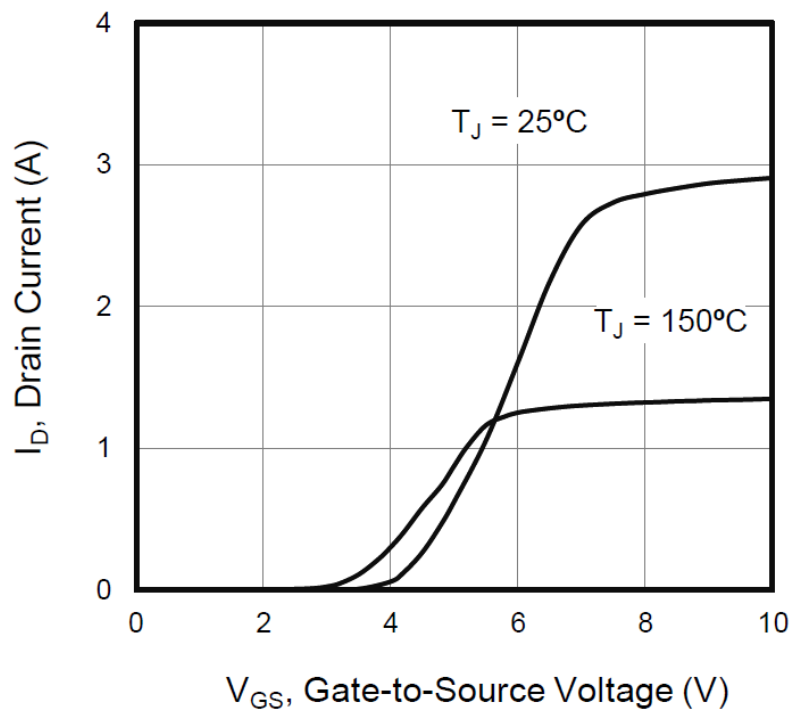
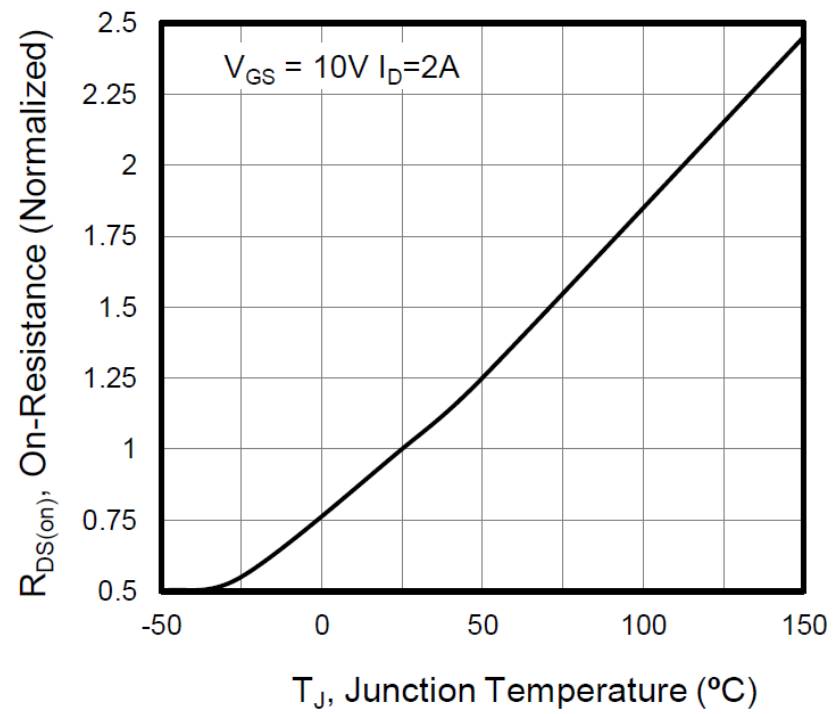
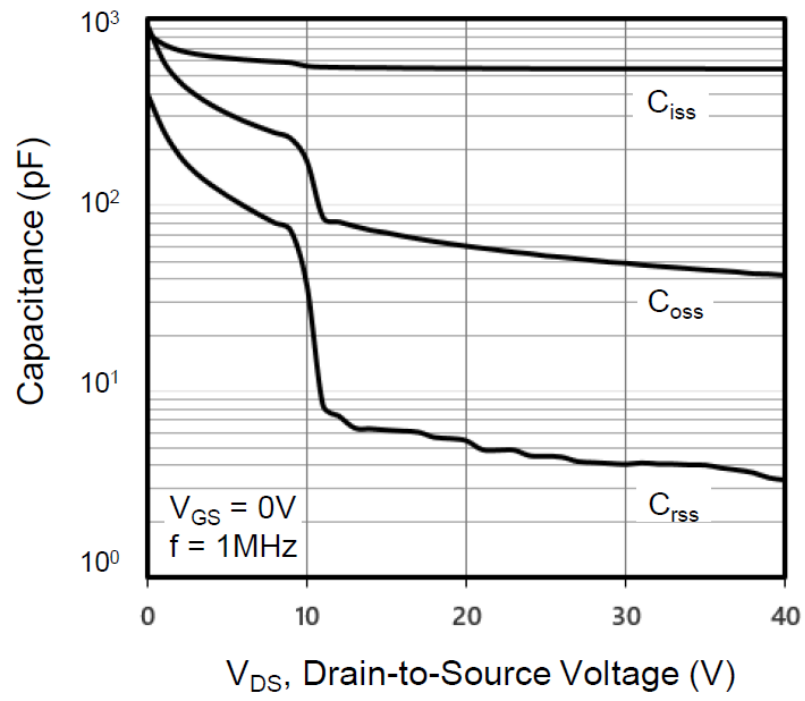

Figure 6. On-Resistance vs. Temperature



**Figure 7. Capacitance**



**Figure 8. Gate Charge**

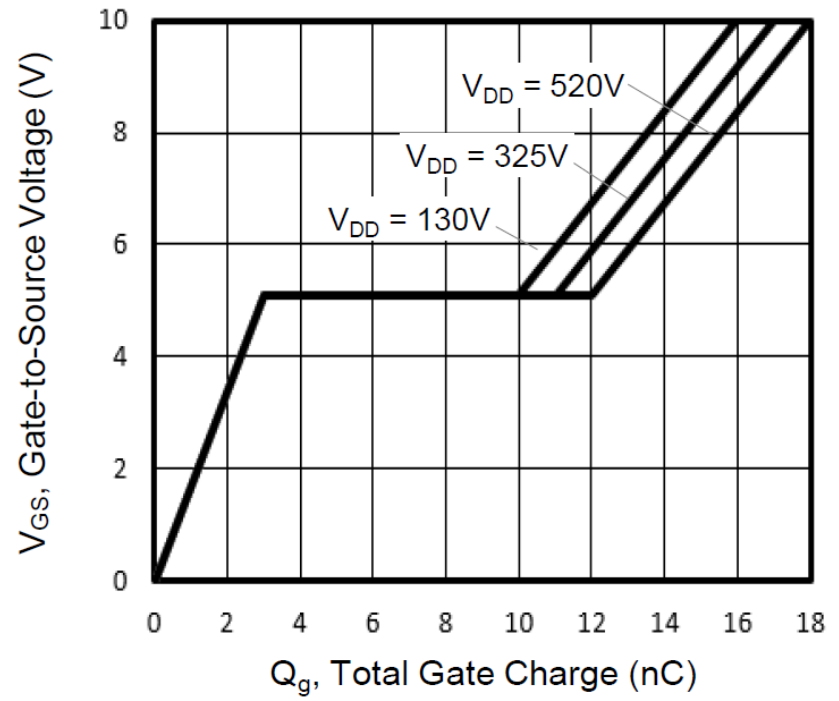

**Figure 9. Transient Thermal Impedance TO-251, TO-252**

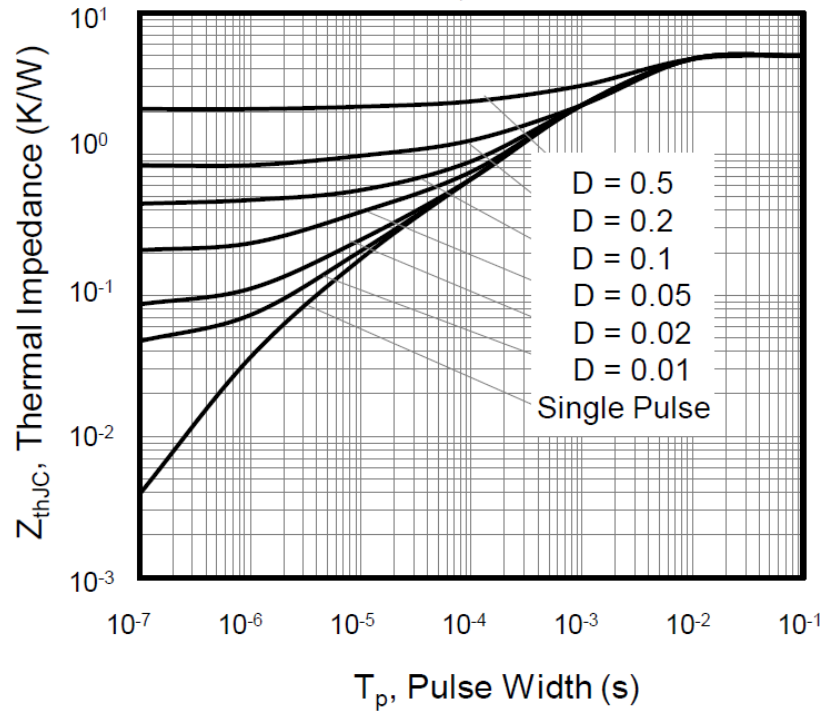

**Figure 10. Transient Thermal Impedance TO-220F**

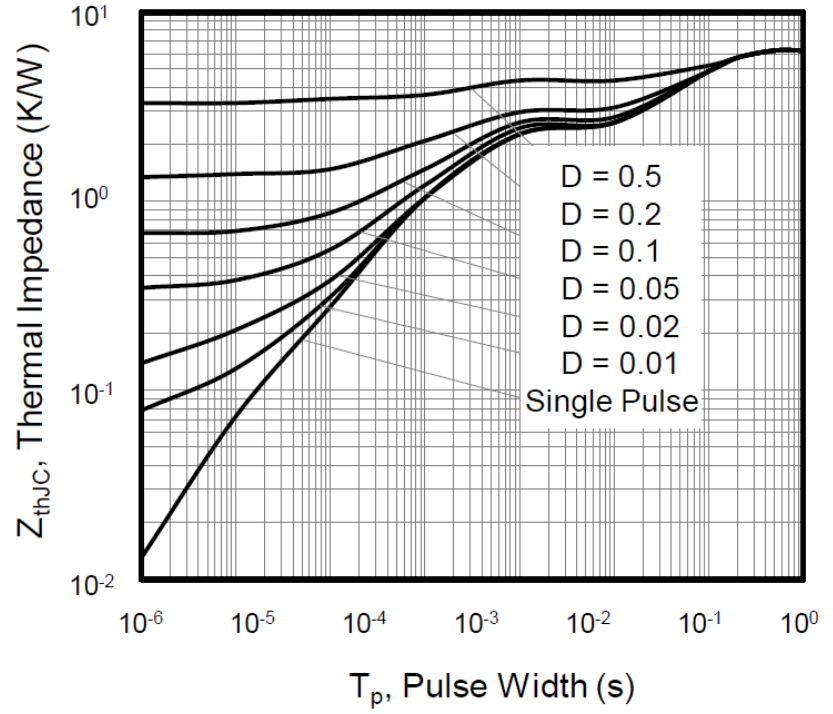

Figure A: Gate Charge Test Circuit and Waveform

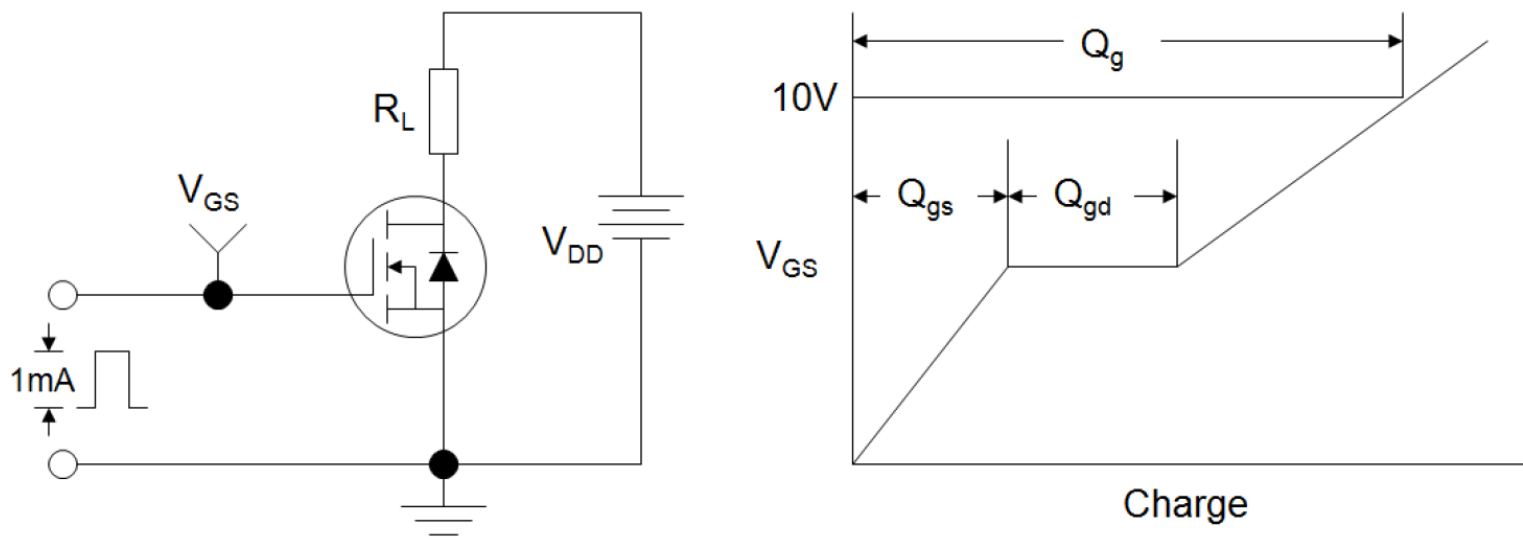

Figure B: Resistive Switching Test Circuit and Waveform

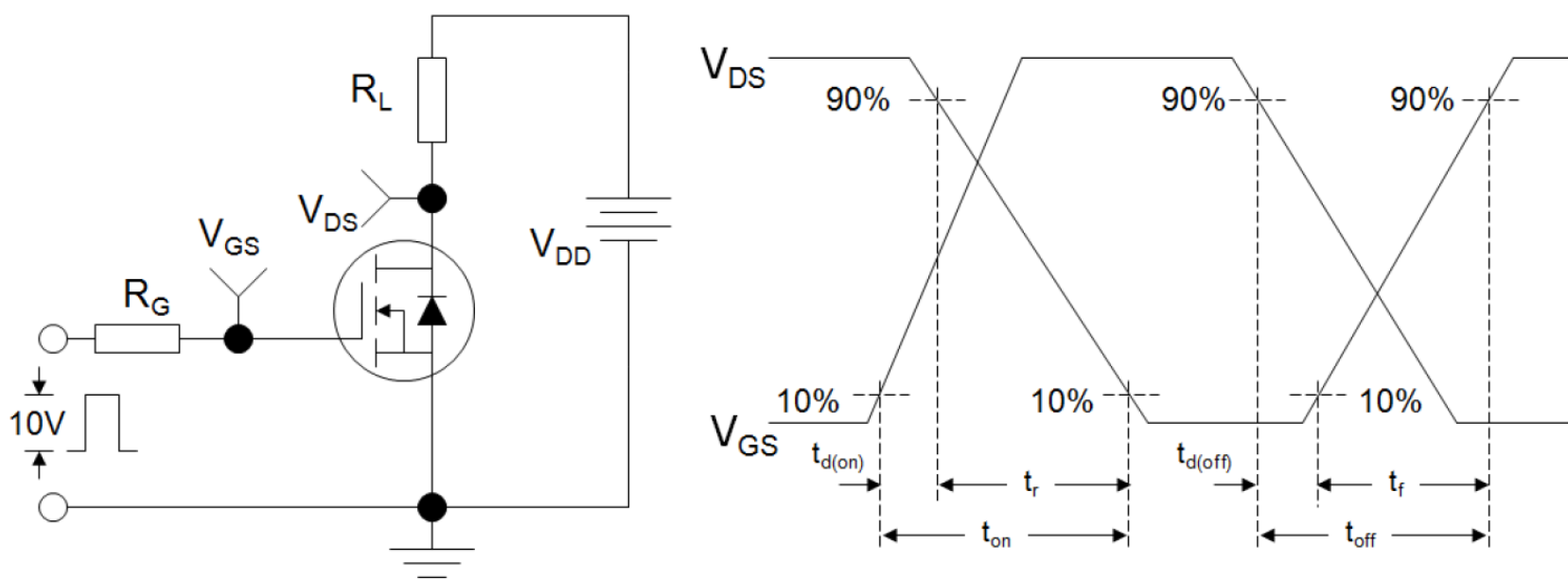
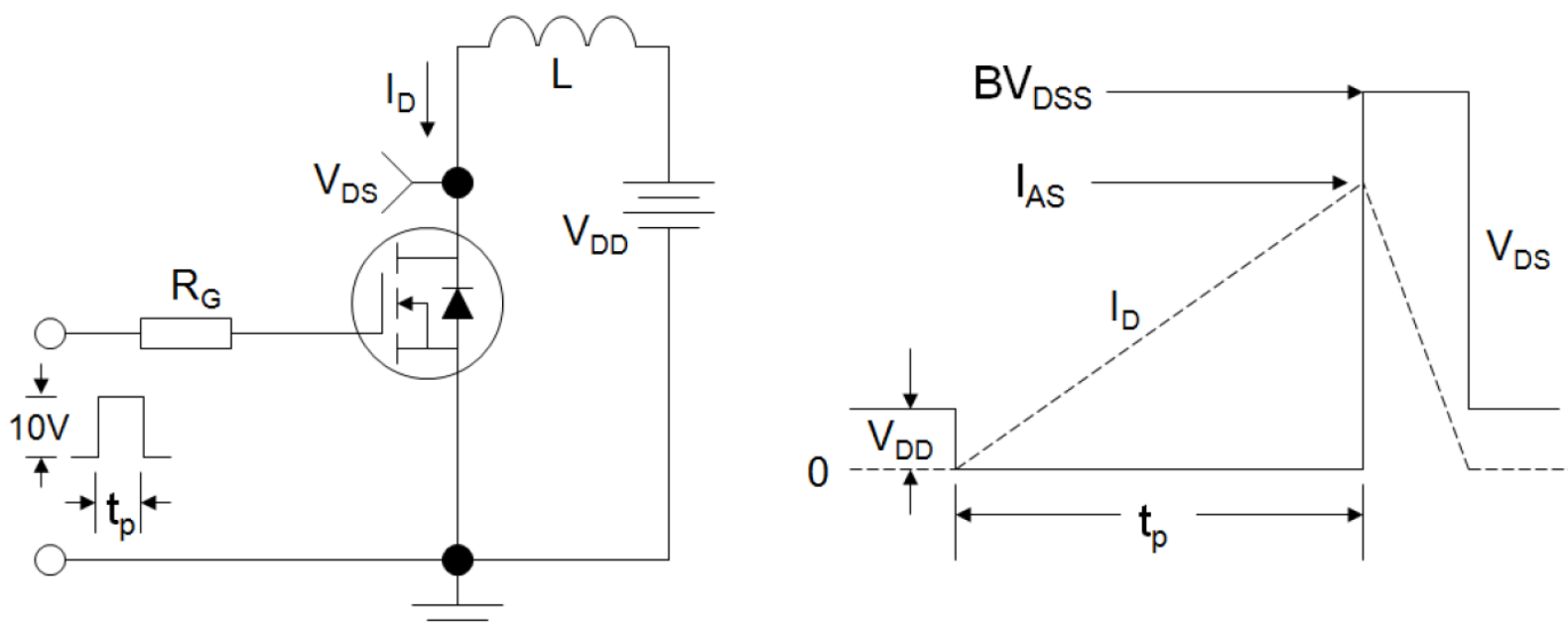
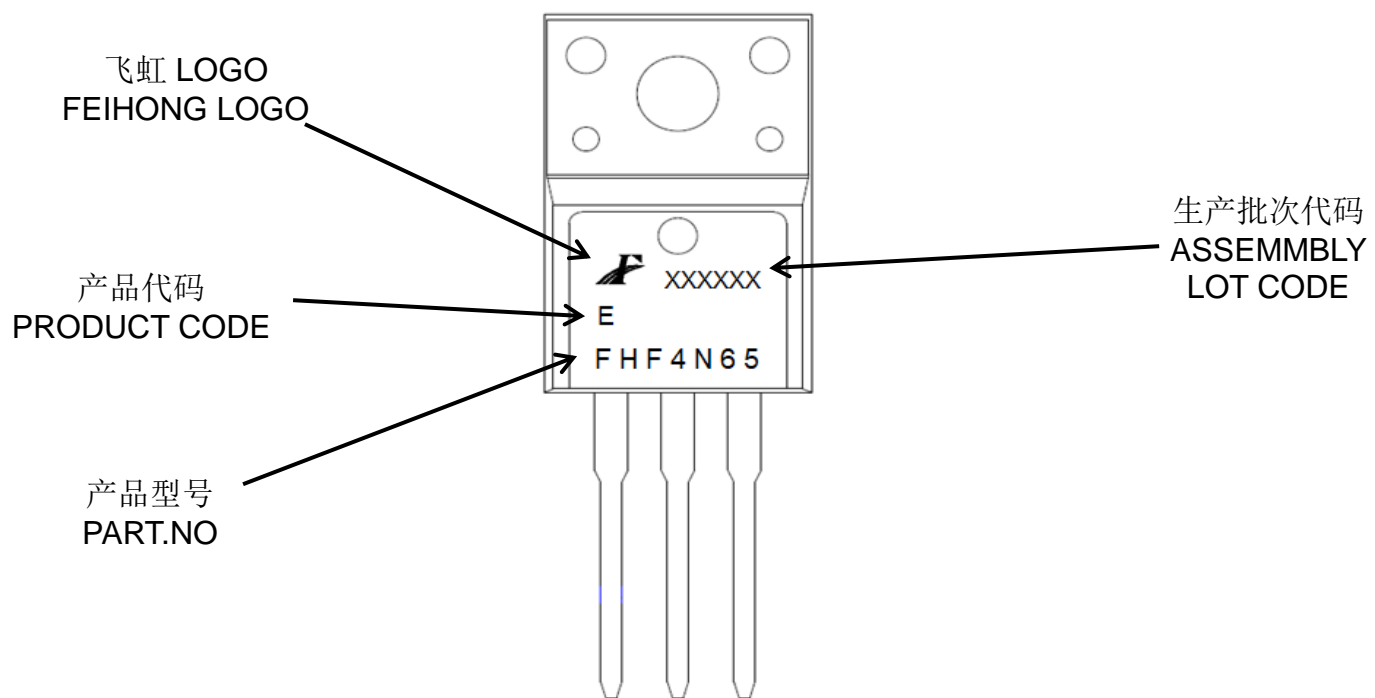
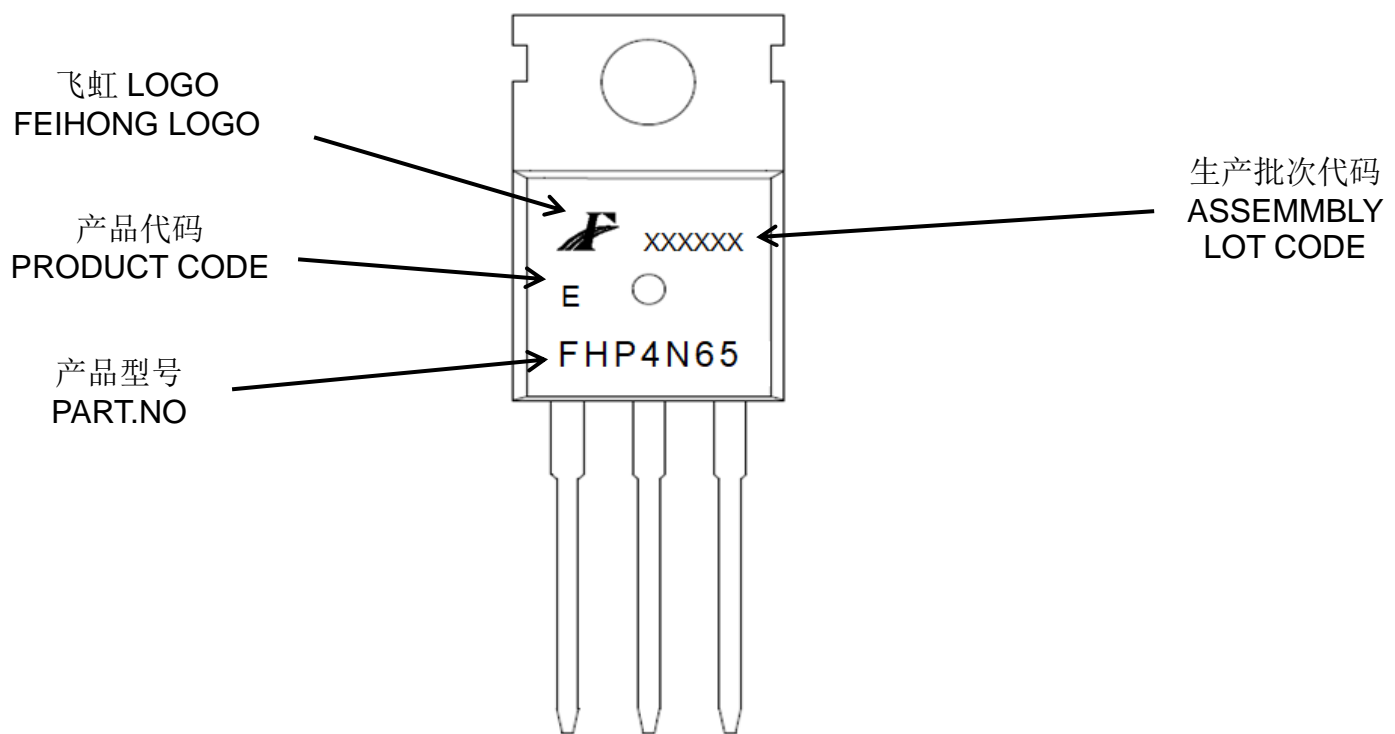
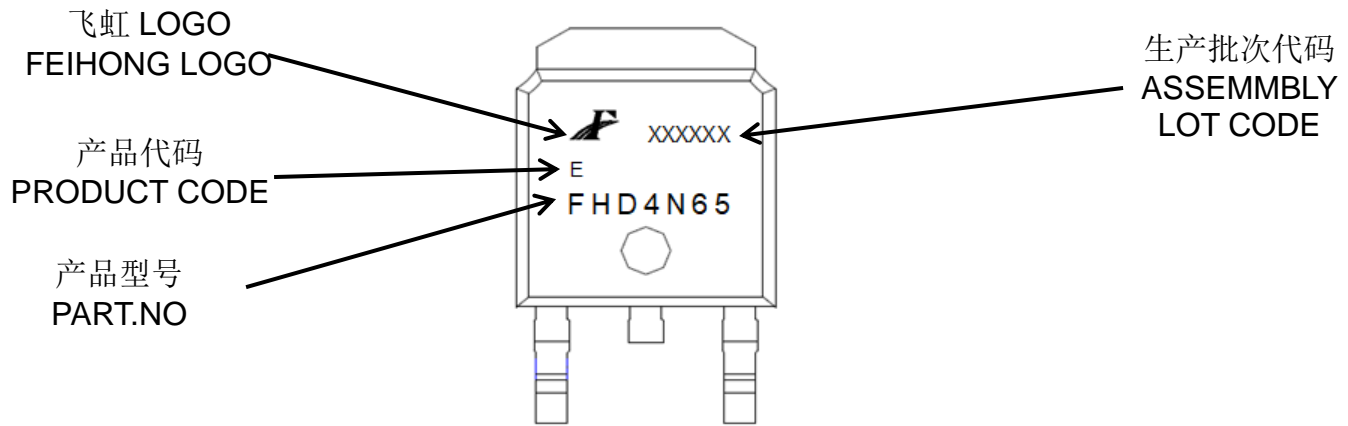
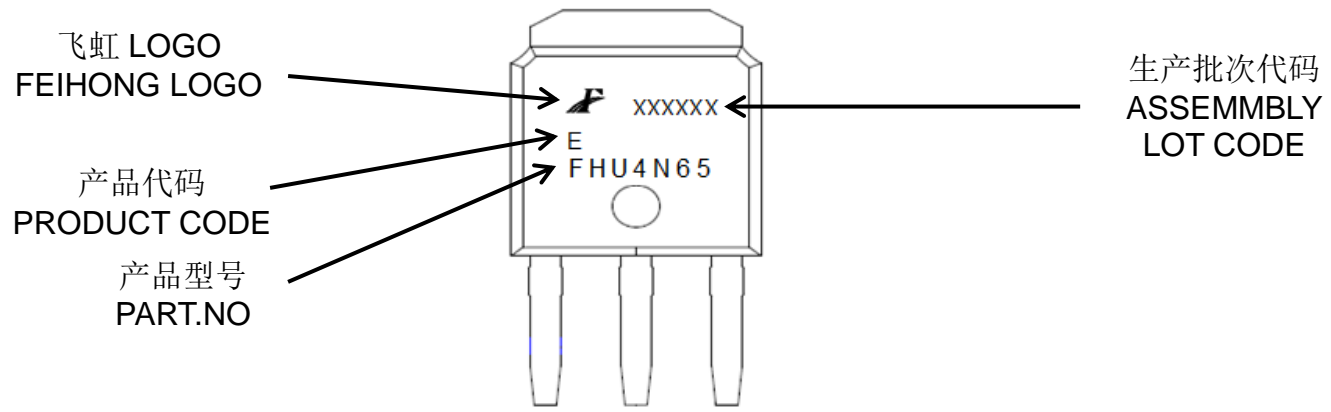

Figure C: Unclamped Inductive Switching Test Circuit and Waveform



印记 Marking:



外形尺寸:

Package Dimension:

TO-251

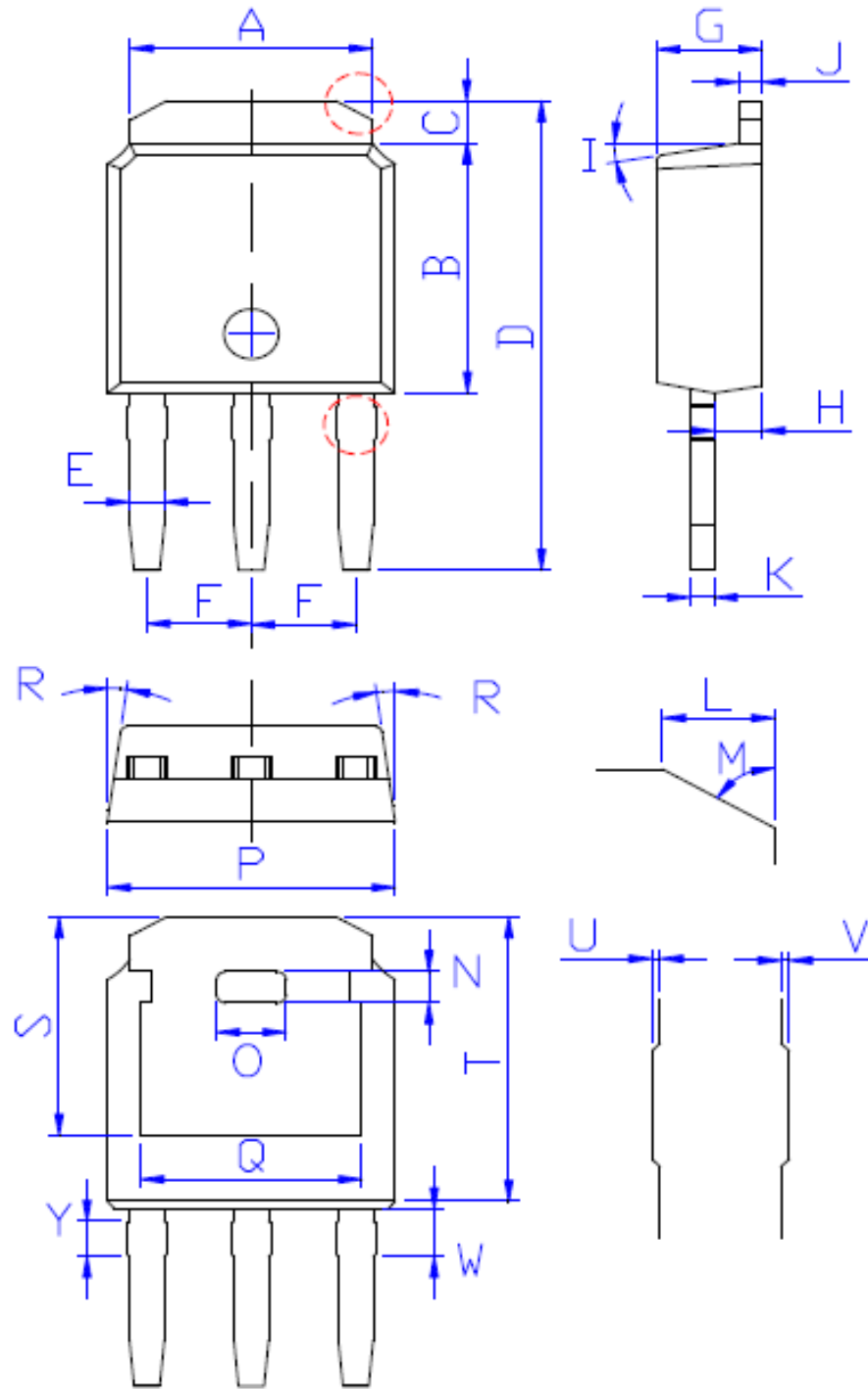

DIM	MILLIMETERS
A	5.34±0.30
B	6.00±0.30
C	1.05±0.30
D	11.31±0.30
E	0.76±0.15
F	2.28±0.15
G	2.30±0.30
H	1.06±0.30
I	(4-10)°
J	0.51±0.15
K	0.52±0.15
L	0.80±0.30
M	60°
N	0.75±0.30
O	1.80±0.30
P	6.60±0.30
Q	4.85±0.30
R	(4-8.5)°
S	5.30±0.30
T	6.90±0.30
U	0.05±0.05
V	0.05±0.05
W	1.15±0.25
Y	0.85±0.25

(Unit: mm)



外形尺寸:

Package Dimension:

TO-252

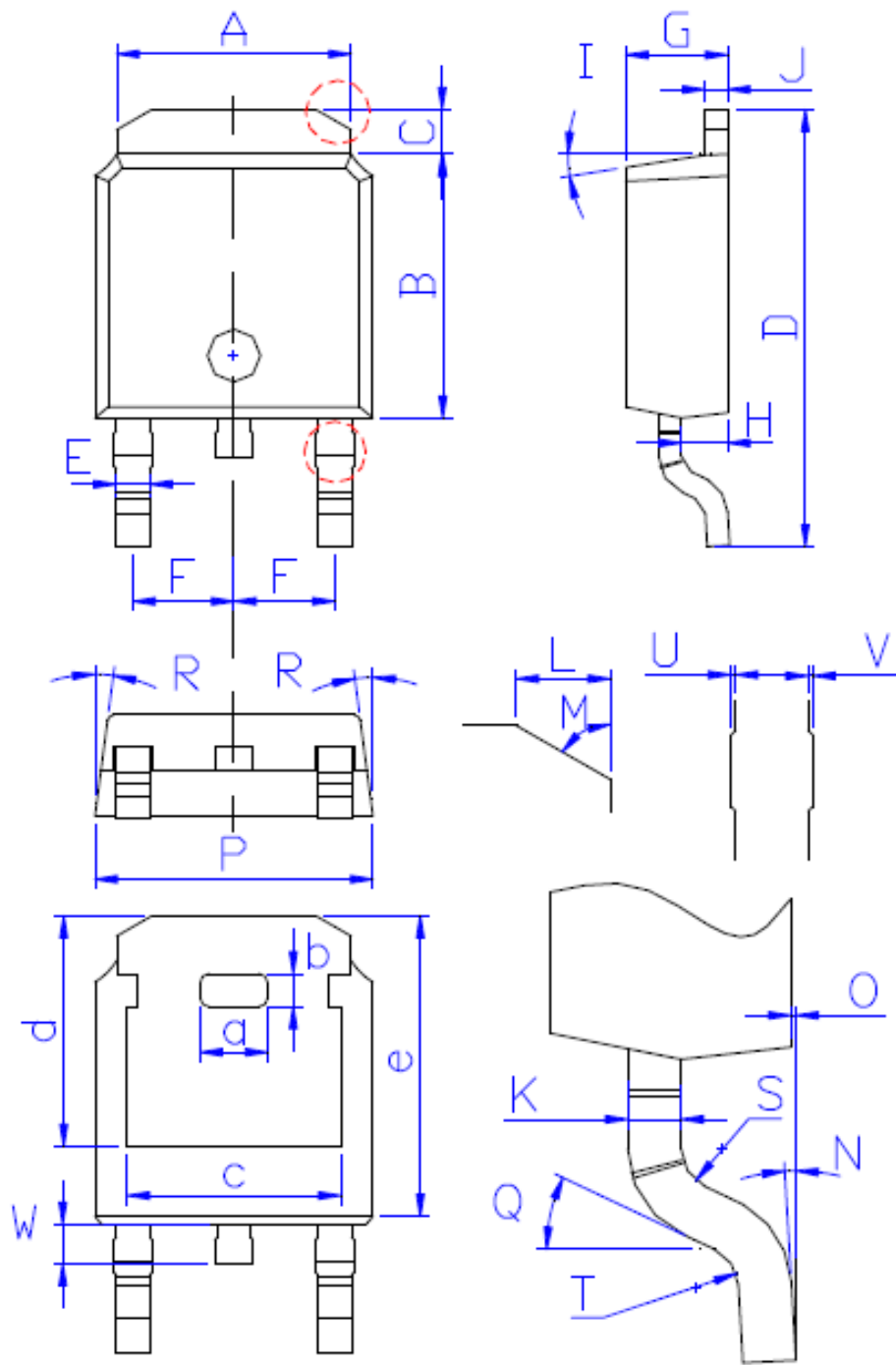

DIM	MILLIMETERS
A	$5.34 \pm 0.30$
B	$6.00 \pm 0.30$
C	$1.05 \pm 0.30$
D	$9.95 \pm 0.30$
E	$0.76 \pm 0.15$
F	$2.28 \pm 0.15$
G	$2.30 \pm 0.30$
H	$1.06 \pm 0.30$
I	$(4-10)^\circ$
J	$0.51 \pm 0.15$
K	$0.52 \pm 0.15$
L	$0.80 \pm 0.30$
M	$60^\circ$
N	$(0-10)^\circ$
O	$0.05 \pm 0.05$
P	$6.60 \pm 0.30$
Q	$25^\circ$
R	$(4-8.5)^\circ$
S	R0.40
T	R0.40
U	$0.05 \pm 0.05$
V	$0.05 \pm 0.05$
W	$0.90 \pm 0.30$
a	$1.80 \pm 0.30$
b	$0.75 \pm 0.30$
c	$4.85 \pm 0.30$
d	$5.30 \pm 0.30$
e	$6.90 \pm 0.30$

(Units: mm)

外形尺寸:

Package Dimension:

TO-220

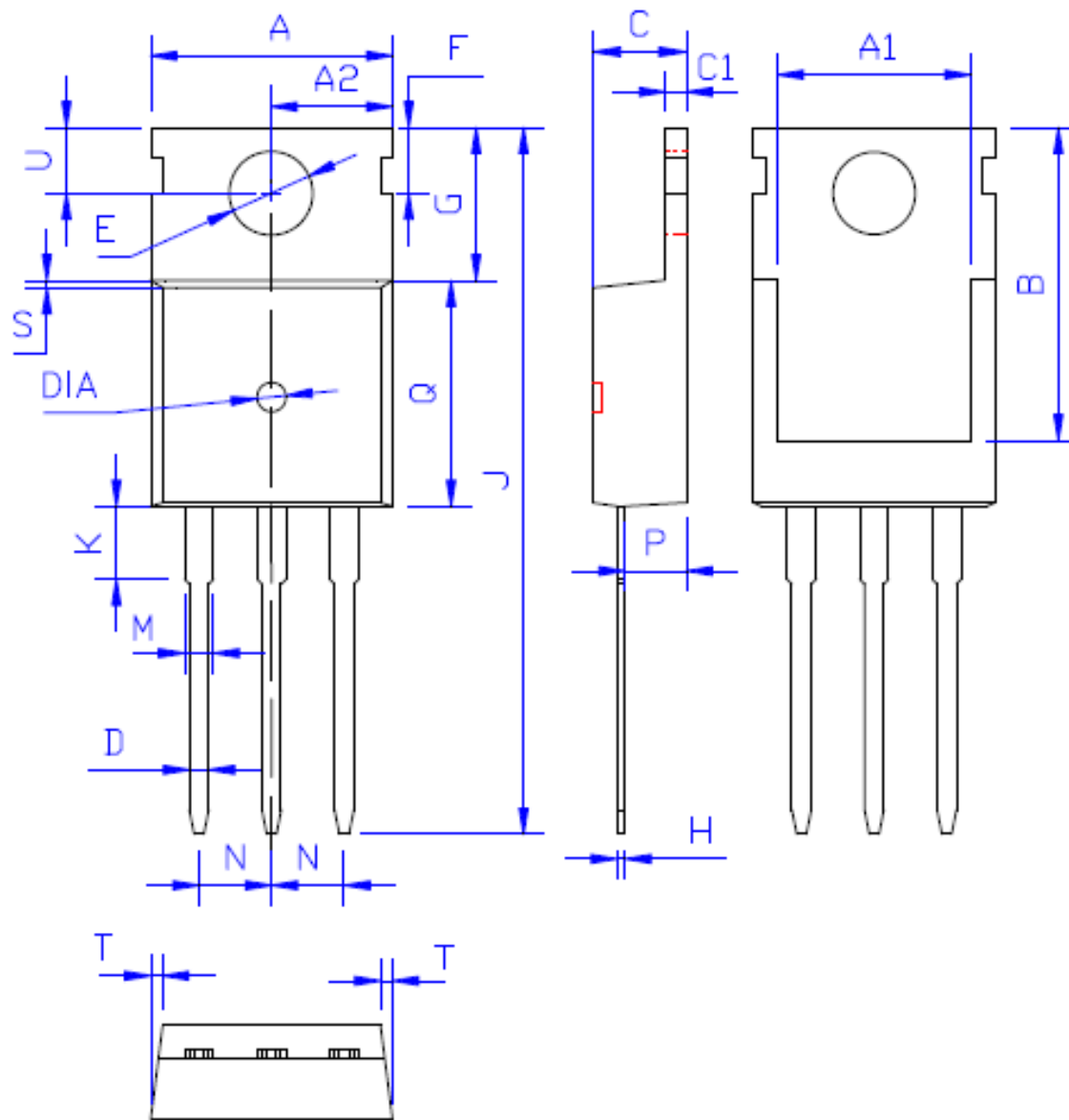

DIM	MILLIMETERS
A	10.00 ± 0.30
A1	8.00 ± 0.30
A2	5.00 ± 0.30
B	13.20 ± 0.40
C	4.50 ± 0.20
C1	1.30 ± 0.20
D	0.80 ± 0.20
E	3.60 ± 0.20
F	3.00 ± 0.30
G	6.60 ± 0.40
H	0.50 ± 0.20
J	28.88 ± 0.50
K	3.00 ± 0.30
M	1.30 ± 0.30
N	Typical 2.54
P	2.40 ± 0.40
Q	9.20 ± 0.40
S	0.25 ± 0.15
T	0.25 ± 0.15
U	2.80 ± 0.30
DIA	宽 1.50 ± 0.10 深 0.50 MAX

(Unit: mm)

外形尺寸:

Package Dimension:

TO-220F

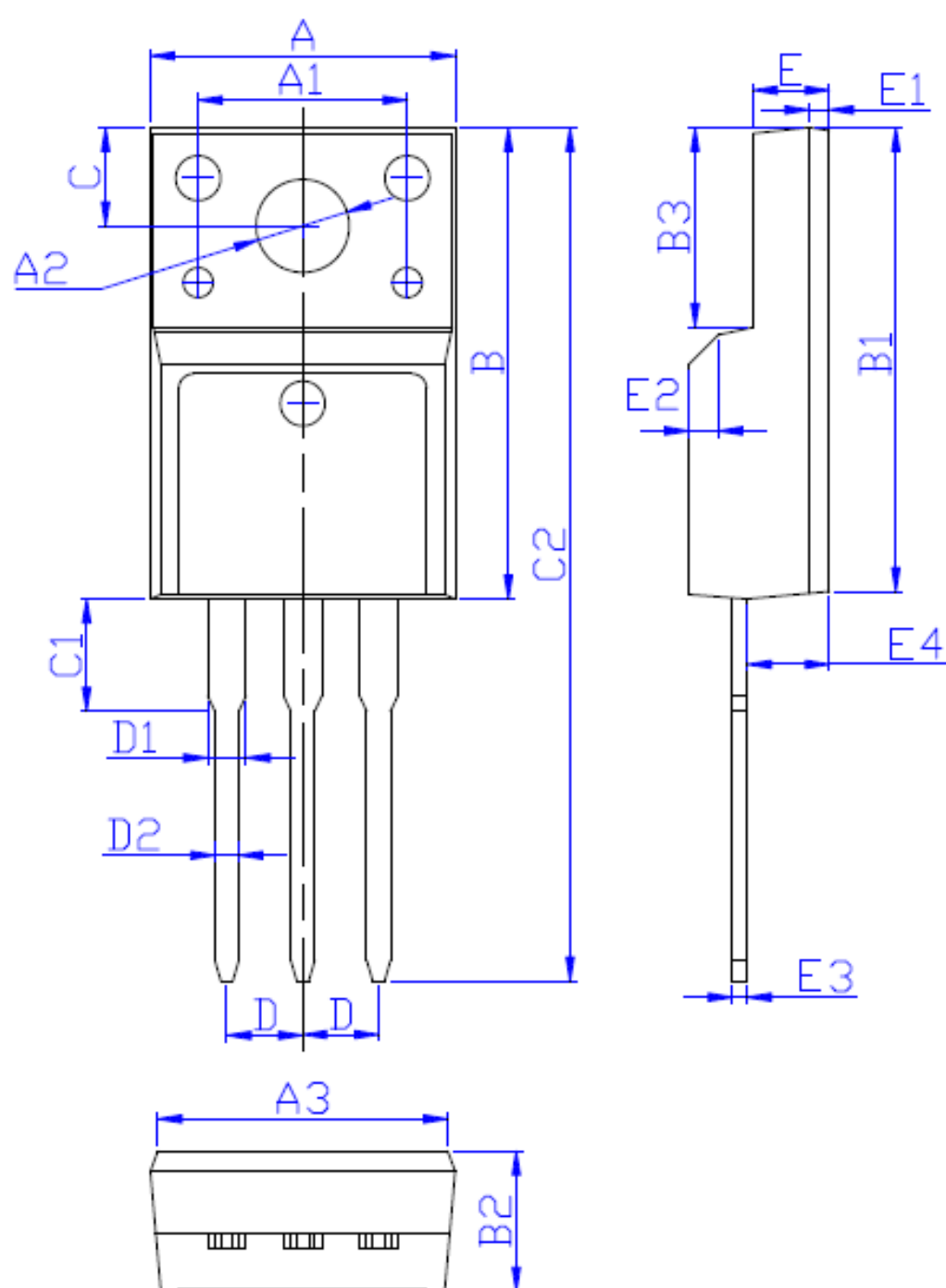

DIM	MILLIMETERS
A	10.16±0.30
A1	7.00±0.20
A2	3.12±0.20
A3	9.70±0.30
B	15.90±0.50
B1	15.60±0.50
B2	4.70±0.30
B3	6.70±0.30
C	3.30±0.25
C1	3.25±0.30
C2	28.70±0.50
D	Typical 2.54
D1	1.47 (MAX)
D2	0.80±0.20
E	2.55±0.25
E1	0.70±0.25
E2	1.0×45°
E3	0.50±0.20
E4	2.75±0.30

(Unit: mm)

## X-ON Electronics

Largest Supplier of Electrical and Electronic Components

*Click to view similar products for [MOSFET](#) category:*

*Click to view products by [FeiHong](#) manufacturer:*

Other Similar products are found below :

[614233C](#) [648584F](#) [MCH3443-TL-E](#) [MCH6422-TL-E](#) [FDPF9N50NZ](#) [FW216A-TL-2W](#) [FW231A-TL-E](#) [APT5010JVR](#) [NTNS3A92PZT5G](#)  
[IRF100S201](#) [JANTX2N5237](#) [2SK2464-TL-E](#) [2SK3818-DL-E](#) [FCA20N60\\_F109](#) [FDZ595PZ](#) [STD6600NT4G](#) [FSS804-TL-E](#) [2SJ277-DL-E](#)  
[2SK1691-DL-E](#) [2SK2545\(Q,T\)](#) [D2294UK](#) [405094E](#) [423220D](#) [MCH6646-TL-E](#) [TPCC8103,L1Q\(CM](#) [367-8430-0972-503](#) [VN1206L](#)  
[424134F](#) [026935X](#) [051075F](#) [SBVS138LT1G](#) [614234A](#) [715780A](#) [NTNS3166NZT5G](#) [751625C](#) [873612G](#) [IRF7380TRHR](#)  
[IPS70R2K0CEAKMA1](#) [RJK60S3DPP-E0#T2](#) [RJK60S5DPK-M0#T0](#) [APT5010JVFR](#) [APT12031JFLL](#) [APT12040JVR](#) [DMN3404LQ-7](#)  
[NTE6400](#) [JANTX2N6796U](#) [JANTX2N6784U](#) [JANTXV2N5416U4](#) [SQM110N05-06L-GE3](#) [SIHF35N60E-GE3](#)