



风华高科

广东风华高新科技股份有限公司

FENGHUA

Fenghua Advanced Technology (Holding) CO., LTD

一、概述

电容器及介质种类：

高频类：此类介质材料的电容器为 类电容器，包括通用型高频 COG、COH 电容器和温度补偿型高频 HG、LG、PH、RH、SH、TH、UJ、SL 电容器。其中 COG、COH 电容器电性能最稳定，几乎不随温度、电压和时间的变化而变化，适用于低损耗，稳定性要求高的高频电路，HG、LG、PH、RH、SH、TH、UJ、SL 电容器容量随温度变化而相应变化，适用于低损耗、温度补偿型电路中。

X7R、X5R、X7S、X6S：此类介质材料的电容器为 类电容器，具有较高的介电常数，容量比 类电容器高，具有较稳定的温度特性，适用于容量范围广，稳定性要求不高的电路中，如隔直、耦合、旁路、鉴频等电路中。

Y5V：此类介质材料的电容器为 类电容器，是所有电容器中介电常数最大的电容器，但其容量稳定性较差，对温度、电压等条件较敏感，适用于要求大容量，温度变化不大的电路中。

Z5U：此类介质材料的电容器为 类电容器，其温度特性介于 X7R 和 Y5V 之间，容量稳定性较差，对温度、电压等条件较敏感，适用于要求大容量，使用温度范围接近于室温的旁路，耦合等，低直流偏压的电路中。

SUMMARY

Types of Dielectric Material and Capacitor

HIGH FREQUENCY TYPE: The capacitor of this kind dielectric material is considered as Class capacitor, including high frequency COG、COH capacitor and temperature compensating capacitor such as HG, LG, PH, RH,SH, TH, UJ, SL. The electrical properties of COG、COH capacitor are the most stable one and change invariably with temperature, voltage and time. They are suited for applications where low-losses and high-stability are required, HG ,LG ,PH ,RH ,SH ,TH ,UJ ,SL capacitor's capacitance changes with temperature.They are suited for applications where low-losses and temperature compensating circuits.

X7R、X5R、X7S、X6S :X7R、X5R、 X7S、X6S material is a kind of material has high dielectric constant. The capacitor made of this kind material is considered as Class capacitor whose capacitance is higher than that of class . These capacitors are classified as having a semi-stable temperature characteristic and used over a wide temperature range, such in these kinds of circuits, DC-blocking, decoupling, bypassing, frequency discriminating etc.

Y5V：The capacitor made of this kind of material is the highest dielectric constant of all ceramic capacitors. They are used over a moderate temperature range in application where high capacitance is required because of its unstable temperature coefficient, but where moderate losses and capacitance changes can be tolerated. Its capacitance and dissipation factors are sensible to measuring conditions, such as temperature and voltage, etc.

Z5U :The capacitor made of this kind of material is considered as Class capacitor, whose temperature characteristic is between that of X7R and Y5V. The capacitance of this kind of capacitor is unstable and sensible to temperature and voltage. Ideally suited for bypassing and decoupling application circuits operating with low DC bias in the environment approaches to room temperature.



二、尺寸及结构 DIMENSIONS AND STRUCTURE

尺寸 DIMENSIONS

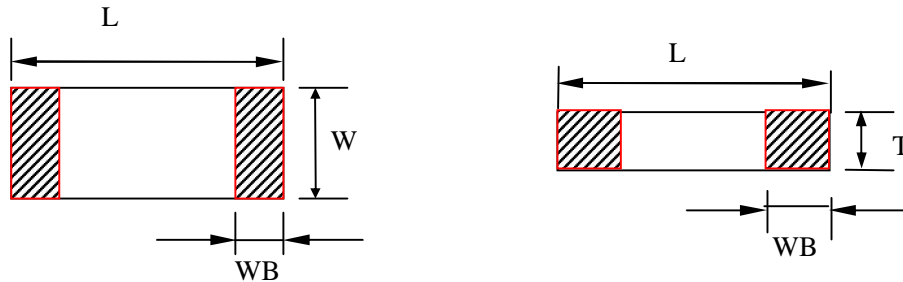

| 型号 Type | | 尺寸 Dimensions (mm) | | | |
|----------------------------|---------------------------|--------------------|-------------|-------------|-------------|
| 英制表示 British expression | 公制表示 Metric expression | L | W | T | WB |
| 0201 | 0603 | 0.6 ± 0.03 | 0.3 ± 0.03 | 0.3 ± 0.03 | 0.15 ± 0.10 |
| 0402 | 1005 | 1.00 ± 0.05 | 0.50 ± 0.05 | 0.50 ± 0.05 | 0.25 ± 0.10 |
| 0603 | 1608 | 1.60 ± 0.10 | 0.80 ± 0.10 | 0.80 ± 0.10 | 0.30 ± 0.10 |
| 0805 | 2012 | 2.00 ± 0.20 | 1.25 ± 0.20 | 0.55 | 0.50 ± 0.20 |
| | | | | 0.80 ± 0.20 | |
| | | | | 1.00 ± 0.20 | |
| | | | | 1.25 ± 0.20 | |
| 1206 | 3216 | 3.20 ± 0.30 | 1.60 ± 0.30 | 0.80 ± 0.20 | 0.60 ± 0.30 |
| | | | | 1.00 ± 0.20 | |
| | | | | 1.25 ± 0.20 | |
| | | | | 1.60 ± 0.30 | |
| 1210 | 3225 | 3.20 ± 0.30 | 2.50 ± 0.30 | 2.80 | 0.60 ± 0.30 |
| 1808 | 4520 | 4.50 ± 0.40 | 2.00 ± 0.20 | 2.20 | 0.60 ± 0.30 |
| 1812 | 4532 | 4.50 ± 0.40 | 3.20 ± 0.30 | 3.50 | 0.60 ± 0.30 |
| 2220 | 5750 | 5.70 ± 0.40 | 5.00 ± 0.40 | 3.50 | 0.60 ± 0.30 |
| 2225 | 5763 | 5.70 ± 0.50 | 6.30 ± 0.50 | 6.20 | 0.60 ± 0.30 |
| 3012 | 7632 | 7.60 ± 0.50 | 3.20 ± 0.30 | 8.10 | 0.60 ± 0.30 |
| 3035 | 7690 | 7.60 ± 0.50 | 9.00 ± 0.50 | 8.10 | 0.60 ± 0.30 |

备注：可根据客户的特殊要求设计符合客户需求的产品。

Note: We can design according to customer special requirements

结构 STRUCTURE

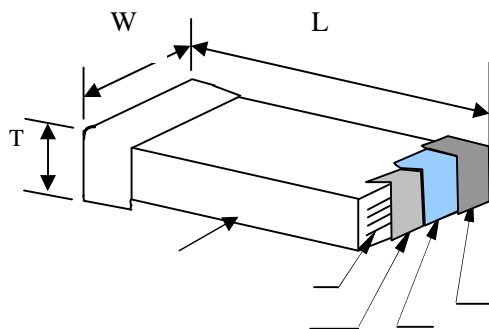

| 序号 NO | 名称 Name |
|----------|----------------------------|
| | 陶瓷介质 Ceramic dielectric |
| | 内电极 Inner electrode |
| | 外电极 Substrate electrode |
| | 镍层 Nickel Layer |
| | 锡层 Tin Layer |



三、型号规格表示方法 HOW TO ORDER

0805 CG 101 J 500 N T

说明 NOTES :

尺寸 DIMENSIONS

| | | | | | | | | | | | |
|----------------------|-----------|-----------|-----------|-----------|-----------|-----------|-----------|-----------|-----------|-----------|-----------|
| 尺寸规格 Size Code | 0201 | 0402 | 0603 | 0805 | 1206 | 1210 | 1808 | 1812 | 2220 | 2225 | 3035 |
| 长×宽 (L×W) inch | 002×001 | 004×002 | 006×003 | 008×005 | 012×006 | 012×010 | 018×008 | 018×012 | 022×020 | 022×025 | 030×035 |
| 长×宽 (L×W) mm | 0.60×0.30 | 1.00×0.50 | 1.60×0.80 | 2.00×1.25 | 3.20×1.60 | 3.20×2.50 | 4.50×2.00 | 4.50×3.20 | 5.70×5.00 | 5.70×6.30 | 7.60×9.00 |

介质种类 DIELECTRIC STYLE

| | | | | | | | | | | | | | | | | |
|---------------------------|---------|---------|----|----|----|----|----|----|----|----|---------|---------|---------|---------|---------|---------|
| 介质种类 (Dielectric Code) | CG | CH | HG | LG | PH | RH | SH | TH | UJ | SL | X | B | BS | DS | E | F |
| 介质材料 (Dielectric) | CO G | CO H | HG | LG | PH | RH | SH | TH | UJ | SL | X5 R | X7 R | X7 S | X6 S | Z5 U | Y5 V |

标称容量 NOMINAL CAPACITANCE

单位(unit) : pF

| 表示方式 (Express Method) | 实际值 (Actual Value) | 注：头两位数字为有效数字，第三位数字为0的个数；R为小数点。 Note: the first two digits are significant; third digit denotes number of zeros; R=decimal point. |
|--------------------------|-----------------------|---|
| 0R5 | 0.5 | |
| 1R0 | 1.0 | |
| 102 | 10 × 10 ² | |
| 224 | 22 × 10 ⁴ | |
| ... | ... | |

容量误差 CAPACITANCE TOLERANCE

| | | | | | | | | | | | |
|-------------------|-------------|-------------|-------------|------------|-----------|-----------|-----------|------|------|--------------|--------------|
| 代码 (Code) | A | B | C | D | F | G | J | K | M | S | Z |
| 误差 (Tolerance) | ± 0.05pF | ± 0.10pF | ± 0.25pF | ± 0.5pF | ± 1.0% | ± 2.0% | ± 5.0% | ±10% | ±20% | +50% -20% | +80% -20% |

备注：A、B、C、D级误差适用于容量 10pF 的产品。

Note :These capacitance tolerance A ,B, C, D are just applicable the capacitance that equals to or less than 10pF.



额定电压 RATED VOLTAGE

单位(unit) : V

| 表示方式 (Express Method) | 实际值 (Actual Value) | 注 :头两位数字为有效数字 ,第三位数字为 0 的个数 ; R 为小数点。 Note: the first two digits are significant; third digit denotes number of zeros; R=decimal point. |
|--------------------------|-----------------------|--|
| 6R3 | 6.3 | |
| 500 | 50×10^0 | |
| 201 | 20×10^1 | |
| 102 | 10×10^2 | |
| ... | ... | |

端头材料 TERMINAL MATERIAL STYLES

| 端头类别 (Termination Styles) | 表示方式 (Express Method) |
|--|-----------------------|
| 纯银端头 (Silver Solderable Termination) | S |
| 纯铜端头 (Copper Solderable Termination) | C |
| 三层电镀端头 (Nickel Barrier Termination) | N |

包装方式 PACKAGE STYLES

| B | T |
|------------------|-------------------------|
| 散包装 (Bulk Bag) | 编带包装 (Taping Package) |

四、温度系数/特性 Temperature Coefficient /Characteristics

| 介质种类 Dielectric | 参考温度点 Reference Temperature Point | 标称温度系数 Temperature Coefficient | 工作温度范围 Operation Temperature Range |
|--------------------|--------------------------------------|-----------------------------------|---------------------------------------|
| COG | 20°C | 0±30 ppm/ | -55 ~ 125 |
| COH | 20°C | 0±60 ppm/ | -55 ~ 125 |
| HG | 20°C | -33±30 ppm/ | -25 ~ 85 |
| LG | 20°C | -75±30 ppm/ | -25 ~ 85 |
| PH | 20°C | -150± 60 ppm/ | -25 ~ 85 |
| RH | 20°C | -220± 60 ppm/ | -25 ~ 85 |
| SH | 20°C | -330± 60 ppm/ | -25 ~ 85 |
| TH | 20°C | -470± 60 ppm/ | -25 ~ 85 |
| UJ | 20°C | -750± 120 ppm/ | -25 ~ 85 |
| SL | 20°C | -1000 ~ +140 ppm/ | -25 ~ 85 |
| X7R | 20°C | ±15% | -55 ~ 125 |
| X5R | 20°C | ±15% | -55 ~ 85 |
| X7S | 20°C | ±22% | -55 ~ 125 |
| X6S | 20°C | ±22% | -55 ~ 105 |
| Z5U | 20°C | -56% ~ +22% | 10 ~ 85 |
| Y5V | 20°C | -80% ~ +30% | -25 ~ 85 |

备注： 类电容器标称温度系数和允许偏差是采用温度在 20°C 和 85°C 之间的电容量变化来确定的，而 类电容器标称温度系数是按照工作范围之间的电容量相对 20°C 的电容量变化来确定的。

Note : Nominal temperature coefficient and allowed tolerance of class are decided by the changing of the capacitance between 20°C and 85°C. Nominal temperature coefficient of class are decided by the temperature of 20°C.



五、容量范围及其电压 Capacitance Range and Operating Voltage

| 尺寸规格 Size Code | 额定电压 Rated Voltage | 容量范围 Capacitance | |
|-------------------|-----------------------|------------------|--------------------|
| | | COG(NPO)(PF) | Y5V (Z5U)(PF) |
| 0201 | 4V | — | — |
| | 6.3V | — | 10,000 ~ 100,000 |
| | 10V | — | — |
| | 16V | — | 10,000 |
| | 25V | — | — |
| | 50V | 0.5 ~ 100 | — |
| 0402 | 4V | — | — |
| | 6.3V | — | 1,000 ~ 1,000,000 |
| | 10V | — | 1,000 ~ 1,000,000 |
| | 16V | — | 1,000 ~ 220,000 |
| | 25V | — | 1,000 ~ 220,000 |
| | 50V | 0.1 ~ 1,000 | 1,000 ~ 100,000 |
| 0603 | 4V | — | — |
| | 6.3V | — | 1,000 ~ 10,000,000 |
| | 10V | — | 1,000 ~ 10,000,000 |
| | 16V | — | 1,000 ~ 2,200,000 |
| | 25V | — | 1,000 ~ 2,200,000 |
| | 50V | 0.1 ~ 6,800 | 1,000 ~ 1,000,000 |
| 0805 | 4V | — | — |
| | 6.3V | — | 1,000 ~ 22,000,000 |
| | 10V | — | 1,000 ~ 22,000,000 |
| | 16V | — | 1,000 ~ 22,000,000 |
| | 25V | — | 1,000 ~ 10,000,000 |
| | 50V | 0.3 ~ 22,000 | 1,000 ~ 4,700,000 |



| 尺寸规格 Size Code | 额定电压 Rated Voltage | 容量范围 Capacitance | |
|-------------------|-----------------------|------------------|----------------------|
| | | COG(NPO)(PF) | Y5V (Z5U)(PF) |
| 1206 | 4V | — | — |
| | 6.3V | — | 1,000 ~ 47,000,000 |
| | 10V | — | 1,000 ~ 47,000,000 |
| | 16V | — | 1,000 ~ 47,000,000 |
| | 25V | — | 1,000 ~ 10,000,000 |
| | 50V | 0.3 ~ 100,000 | 1,000 ~ 10,000,000 |
| 1210 | 6.3V | — | 4,700 ~ 100,000,000 |
| | 10V | — | 4,700 ~ 47,000,000 |
| | 16V | — | 4,700 ~ 22,000,000 |
| | 25V | — | 4,700 ~ 10,000,000 |
| | 50V | 10 ~ 100,000 | 4,700 ~ 10,000,000 |
| 1808 | 6.3V | — | — |
| | 10V | — | — |
| | 16V | — | — |
| | 25V | — | — |
| | 50V | 10 ~ 100,000 | — |
| 1812 | 6.3V | — | 10,000 ~ 100,000,000 |
| | 10V | — | 10,000 ~ 100,000,000 |
| | 16V | — | 10,000 ~ 22,000,000 |
| | 25V | — | 10,000 ~ 10,000,000 |
| | 50V | 10 ~ 100,000 | 10,000 ~ 10,000,000 |



| 尺寸规格 Size Code | 额定电压 Rated Voltage | 容量范围 Capacitance | | | |
|-------------------|-----------------------|------------------|------------------------|-------------------|------------|
| | | X7R (PF) | X7S(PF) | X5R(uF) | X6S(uF) |
| 0201 | 4V | — | — | 0.015 uF ~ 1uF | — |
| | 6.3V | — | — | 0.015 uF ~ 1uF | — |
| | 10V | 100 ~ 10,000 | — | 0.015 uF ~ 0.1 uF | — |
| | 16V | 100 ~ 10,000 | — | — | — |
| | 25V | 100 ~ 10,000 | — | — | — |
| | 50V | — | — | — | — |
| 0402 | 4V | — | — | 0.1uF~10uF | 0.1~2.2 uF |
| | 6.3V | 100 ~ 470,000 | 100,000 ~ 470,000 | 0.1uF~4.7uF | 0.1~2.2 uF |
| | 10V | 100 ~ 470,000 | 100,000 ~ 470,000 | 0.1uF~4.7uF | 0.1~1 uF |
| | 16V | 100 ~ 220,000 | 47,000 ~ 220,000 | 0.1uF~2.2 uF | — |
| | 25V | 100 ~ 100,000 | 22,000 ~ 100,000 | 0.1uF~2.2 uF | — |
| | 50V | 100 ~ 100,000 | 4,700 ~ 100,000 | 0.047uF~0.1 uF | — |
| 0603 | 4V | — | — | 0.47uF ~ 22uF | 0.1~10 uF |
| | 6.3V | 150 ~ 2,200,000 | 470,000 ~ 2,200,000 | 0.47uF ~ 22uF | 0.1~10 uF |
| | 10V | 150 ~ 2,200,000 | 470,000 ~ 2,200,000 | 0.47uF ~ 10uF | 0.1~10 uF |
| | 16V | 150 ~ 1,000,000 | 470,000 ~ 1,000,000 | 0.47uF ~ 10uF | 0.1~4.7 uF |
| | 25V | 150 ~ 1,000,000 | 470,000 ~ 1,000,000 | 0.47uF ~ 10uF | 0.1~4.7 uF |
| | 50V | 150 ~ 470,000 | — | 0.47uF ~ 1uF | — |
| 0805 | 4V | — | — | 1uF ~ 47uF | 0.1~47 uF |
| | 6.3V | 150 ~ 10,000,000 | 1,000,000 ~ 10,000,000 | 1uF ~ 47uF | 0.1~22 uF |
| | 10V | 150 ~ 10,000,000 | 1,000,000 ~ 10,000,000 | 1uF ~ 22uF | 0.1~10 uF |
| | 16V | 150 ~ 4,700,000 | 1,000,000 ~ 4,700,000 | 1uF ~ 22uF | 0.1~10 uF |
| | 25V | 150 ~ 4,700,000 | 1,000,000 ~ 4,700,000 | 1uF ~ 10uF | 0.1~10 uF |
| | 50V | 150 ~ 1,000,000 | — | — | — |



| 尺寸规格 Size Code | 额定电压 Rated Voltage | 容量范围 Capacitance | | | |
|-------------------|-----------------------|------------------|------------------------|---------------|------------|
| | | X7R (PF) | X7S (PF) | X5R(uF) | X6S(uF) |
| 1206 | 4V | — | — | 2.2uF ~ 100uF | — |
| | 6.3V | 200 ~ 22,000,000 | 2,200,000 ~ 22,000,000 | 2.2uF ~ 100uF | 0.1~100 uF |
| | 10V | 200 ~ 22,000,000 | 2,200,000 ~ 22,000,000 | 2.2uF ~ 47uF | 0.1~22 uF |
| | 16V | 200 ~ 10,000,000 | 2,200,000 ~ 10,000,000 | 2.2uF ~ 22uF | 0.1~22 uF |
| | 25V | 200 ~ 10,000,000 | 1,500,000 ~ 10,000,000 | 2.2uF ~ 22uF | 0.1~10 uF |
| | 50V | 200 ~ 4,700,000 | 1,000,000 ~ 4,700,000 | 2.2uF ~ 10uF | — |
| 1210 | 6.3V | 220 ~ 47,000,000 | — | 47uF ~ 100uF | 0.1~100 uF |
| | 10V | 220 ~ 47,000,000 | — | 4.7uF ~ 100uF | 0.1~47 uF |
| | 16V | 220 ~ 22,000,000 | 3,300,000 ~ 22,000,000 | 4.7uF ~ 47uF | 0.1~22 uF |
| | 25V | 220 ~ 22,000,000 | 2,200,000 ~ 22,000,000 | 4.7uF ~ 22uF | 0.1~22 uF |
| | 50V | 220 ~ 10,000,000 | 1,000,000 ~ 10,000,000 | — | — |
| 1808 | 6.3V | 220 ~ 4,700,000 | — | 4.7uF ~ 100uF | — |
| | 10V | 220 ~ 4,700,000 | — | 4.7uF ~ 47uF | — |
| | 16V | 220 ~ 4,700,000 | — | 4.7uF ~ 22uF | — |
| | 25V | 220 ~ 4,700,000 | — | 4.7uF ~ 10uF | — |
| | 50V | 220 ~ 4,700,000 | — | — | — |
| 1812 | 6.3V | — | — | 10uF ~ 100uF | — |
| | 10V | — | — | 10uF ~ 47uF | — |
| | 16V | 470 ~ 6,800,000 | — | 4.7uF ~ 22uF | — |
| | 25V | 470 ~ 6,800,000 | — | 4.7uF ~ 10uF | — |
| | 50V | 470 ~ 4,700,000 | — | — | — |

备注：可根据客户的特殊要求设计符合客户需求的产品。

Note : We can design according to customer special requirements .



六、高 Q 值 COG 电容器 Hi-Q COG MLCC

应用:

适合于射频 RF 电路及要求 Hi-Q、低 ESR、高频率响应的微波电路中。

CQ、CG 电容器说明：

下述 Q 值标准是相对通用客户而制定的，对要求更高 Q 值产品的客户，可专门设计和生产。

使用频率在 1MHz~2.4GHz 之间，对要求更高频率产品的客户，可根据客户的要求另外专门设计。

CQ 比 CG 相对可应用频率略高,请客户按需选定。

Application:

Hi-Q COG capacitors are ideally suited for RF and microwave application requiring high Q, low ESR, and high resonant frequency.

Note for CQ and CG:

The following Q value is just confirmed by general customer. If there is a higher requirement for Q value requirements, we can design and produce according to the special requirements.

For the customer whose requirements for frequency is between 1MHz and 2.4GHz or higher frequency, we can design it according to their requirements.

The frequency of CQ is a little higher than that of CG. Please choose them according to your requirements.

CQ 电容器的容量值及其 Q 值 CQ Capacitance value and Q value

| 容量 Capacitance (pF) | 300MHz 时的Q 值 Q value at 300MHz | | 容量 Capacitance (pF) | 300MHz 时的Q 值 Q value at 300MHz | | 容量 Capacitance (pF) | 300MHz 时的Q 值 Q value at 300MHz | |
|---------------------------|-----------------------------------|------|---------------------------|-----------------------------------|------|---------------------------|-----------------------------------|------|
| | 0805 | 0603 | | 0805 | 0603 | | 0805 | 0603 |
| | 4.7 | 1000 | | 800 | 12 | | 400 | 320 |
| 5.2 | 900 | 720 | 13 | 375 | 300 | 33 | 140 | 112 |
| 5.6 | 850 | 680 | 14 | 350 | 280 | 36 | 130 | 104 |
| 6.2 | 800 | 640 | 15 | 325 | 260 | 39 | 120 | 96 |
| 6.8 | 700 | 560 | 16 | 300 | 240 | 43 | 110 | 88 |
| 7.5 | 650 | 520 | 18 | 250 | 200 | 47 | 100 | 80 |
| 8.2 | 575 | 460 | 20 | 225 | 180 | 56 | 80 | 80 |
| 9.1 | 525 | 420 | 22 | 215 | 172 | 62 | 80 | 80 |
| 10 | 500 | 400 | 24 | 200 | 160 | 68 | 80 | 80 |
| 11 | 450 | 360 | 27 | 175 | 140 | 82 | 80 | 80 |



七、中高压电容器 HIGH VOLTAGE MLCC

中高压多层片状陶瓷电容器是在多层片状陶瓷电容器的工艺技术、设备基础上，通过采用特殊工艺制作的一种具有良好高压可靠性的产品，该产品适合于表面贴装，适合于多种直流高压线路，可以有效的改善电子线路的性能。

应用范围

- 模拟或数字调制解调器。
- 局域网/广域网接口界面。
- 日光灯启动辉器照明电路。
- 倍压电器。
- 直流变速器。
- 背光源驱动电路。

Middle & high voltage MLCC is a kind of special design 、 special technology MLCC that bases on the technology of general MLCC. This kind of MLCC has stable high voltage reliability and suitable to SMT. Middle & high MLCC is widely applicable for many direct high voltage circuits in which it can improve the performance of the circuit.

APPLICATIONS

- Analog & Digital Modems
- LAN/WAN Interface
- Lighting Ballast Circuits
- Voltage Multipliers
- DC-DC Converters
- Back-lighting Inverters

容量范围及其电压

单位/unit: pF

| 尺寸规格 Size Code | 工作电压 Rated Voltage | 容量范围 Capacitance | | |
|-------------------|-----------------------|------------------|-----------------|------------------|
| | | NPO | X7R | Y5V |
| 0603 | 100V | 0.5 ~ 1,000 | 150 ~ 100,000 | 2,200 ~ 100,000 |
| | 200V | 0.5 ~ 470 | 150 ~ 10,000 | —— |
| | 250V | 0.5 ~ 470 | 150 ~ 10,000 | —— |
| 0805 | 100V | 0.5 ~ 3,300 | 150 ~ 100,000 | 10,000 ~ 100,000 |
| | 200V | 0.1 ~ 1,500 | 150 ~ 22,000 | 10,000 ~ 47,000 |
| | 250V | 0.1 ~ 1,500 | 150 ~ 22,000 | 10,000 ~ 47,000 |
| | 500V | 0.1 ~ 470 | 150 ~ 10,000 | —— |
| | 630V | 0.1 ~ 470 | 150 ~ 10,000 | —— |
| | 1000V | 0.1 ~ 100 | —— | —— |
| 1206 | 100V | 0.5 ~ 3,300 | 150 ~ 1,000,000 | 15,000 ~ 470,000 |
| | 200V | 0.1 ~ 2,700 | 150 ~ 220,000 | 10,000 ~ 220,000 |
| | 250V | 0.1 ~ 2,700 | 150 ~ 220,000 | 10,000 ~ 220,000 |
| | 500V | 0.1 ~ 1,500 | 150 ~ 33,000 | —— |
| | 630V | 0.1 ~ 1,500 | 150 ~ 33,000 | —— |
| | 1000V | 0.1 ~ 1,000 | 150 ~ 10,000 | —— |
| | 2000V | 0.1 ~ 270 | 150 ~ 2,700 | —— |



容量范围及其电压

单位/unit: pF

| 尺寸规格 Size Code | 工作电压 Rated Voltage | 容量范围 Capacitance | | |
|-------------------|-----------------------|------------------|--------------------|---------------------|
| | | NPO | X7R | Y5V |
| 1210 | 100V | 1.0 ~ 6,800 | 150 ~ 2,200,000 | 15,000 ~ 1,000,000 |
| | 200V | 1.0 ~ 3,300 | 150 ~ 220,000 | 15,000 ~ 470,000 |
| | 250V | 1.0 ~ 3,300 | 150 ~ 220,000 | 15,000 ~ 470,000 |
| | 500V | 1.0 ~ 2,200 | 150 ~ 68,000 | —— |
| | 630V | 1.0 ~ 2,200 | 150 ~ 68,000 | —— |
| | 1000V | 1.0 ~ 1,000 | 150 ~ 22,000 | —— |
| | 2000V | 1.0 ~ 470 | 150 ~ 10,000 | —— |
| | 3000V | —— | 150 ~ 680 | —— |
| | 4000V | —— | 150 ~ 680 | —— |
| 1808 | 100V | 2.0 ~ 4,700 | 220 ~ 2,200,000 | 150,000 ~ 1,000,000 |
| | 200V | 2.0 ~ 3,900 | 220 ~ 220,000 | 10,000 ~ 390,000 |
| | 250V | 2.0 ~ 3,900 | 220 ~ 220,000 | 10,000 ~ 390,000 |
| | 500V | 2.0 ~ 2,700 | 220 ~ 68,000 | —— |
| | 630V | 2.0 ~ 2,700 | 220 ~ 68,000 | —— |
| | 1000V | 2.0 ~ 1,000 | 150 ~ 22,000 | —— |
| | 2000V | 2.0 ~ 470 | 150 ~ 10,000 | —— |
| | 3000V | 2.0 ~ 330 | 150 ~ 4,700 | —— |
| | 4000V | 2.0 ~ 33 | 150 ~ 2,200 | —— |
| 1812 | 100V | 3.0 ~ 10,000 | 270 ~ 1,000,000 | 150,000 ~ 2,200,000 |
| | 200V | 3.0 ~ 6,800 | 270 ~ 560,000 | 100,000 ~ 470,000 |
| | 250V | 3.0 ~ 6,800 | 270 ~ 560,000 | 100,000 ~ 470,000 |
| | 500V | 3.0 ~ 4,700 | 270 ~ 150,000 | —— |
| | 630V | 3.0 ~ 4,700 | 270 ~ 150,000 | —— |
| | 1000V | 3.0 ~ 1,200 | 270 ~ 56,000 | —— |
| | 2000V | 3.0 ~ 1,000 | 270 ~ 12,000 | —— |
| | 3000V | 3.0 ~ 560 | 270 ~ 4,700 | —— |
| | 4000V | 3.0 ~ 220 | 270 ~ 3,300 | —— |
| 1825 | 100V | 3.0 ~ 22,000 | 12,000 ~ 1,200,000 | 150,000 ~ 2,200,000 |
| | 200V | 3.0 ~ 8,200 | 12,000 ~ 1,000,000 | 100,000 ~ 470,000 |
| | 250V | 3.0 ~ 8,200 | 12,000 ~ 1,000,000 | 100,000 ~ 470,000 |
| | 500V | 3.0 ~ 5,600 | 1,000 ~ 470,000 | —— |
| | 630V | 3.0 ~ 5,600 | 1,000 ~ 470,000 | —— |
| | 1000V | 3.0 ~ 1,800 | 1,000 ~ 100,000 | —— |
| | 2000V | 3.0 ~ 1,000 | 1,000 ~ 22,000 | —— |
| | 3000V | 3.0 ~ 680 | 1,000 ~ 10,000 | —— |
| | 4000V | 3.0 ~ 470 | 1,000 ~ 6,800 | —— |
| 5000V | 3.0 ~ 82 | —— | —— | |



| 尺寸规格 Size Code | 工作电压 Rated Voltage | 容量范围 Capacitance | | |
|-------------------|-----------------------|------------------|--------------------|---------------------|
| | | NPO | X7R | Y5V |
| 2220 | 100V | 5.0 ~ 27,000 | 22,000 ~ 1,200,000 | 150,000 ~ 1,500,000 |
| | 200V | 5.0 ~ 12,000 | 22,000 ~ 1,000,000 | 100,000 ~ 1,000,000 |
| | 250V | 5.0 ~ 12,000 | 22,000 ~ 1,000,000 | 100,000 ~ 1,000,000 |
| | 500V | 5.0 ~ 6,800 | 1,500 ~ 470,000 | —— |
| | 630V | 5.0 ~ 6,800 | 1,500 ~ 470,000 | —— |
| | 1000V | 5.0 ~ 3,900 | 1,500 ~ 100,000 | —— |
| | 2000V | 5.0 ~ 1,000 | 1,500 ~ 33,000 | —— |
| | 3000V | 5.0 ~ 680 | 1,500 ~ 10,000 | —— |
| | 4000V | 5.0 ~ 560 | 1,500 ~ 6,800 | —— |
| | 5000V | 5.0 ~ 120 | —— | —— |
| 2225 | 100V | 5.0 ~ 27,000 | 2,200 ~ 2,200,000 | 250,000 ~ 3,300,000 |
| | 200V | 5.0 ~ 12,000 | 2,200 ~ 2,200,000 | 220,000 ~ 2,200,000 |
| | 250V | 5.0 ~ 12,000 | 2,200 ~ 2,200,000 | 220,000 ~ 2,200,000 |
| | 500V | 5.0 ~ 6,800 | 2,200 ~ 470,000 | —— |
| | 630V | 5.0 ~ 6,800 | 2,200 ~ 470,000 | —— |
| | 1000V | 5.0 ~ 3,900 | 2,200 ~ 100,000 | —— |
| | 2000V | 5.0 ~ 1,000 | 2,200 ~ 47,000 | —— |
| | 3000V | 5.0 ~ 680 | 2,200 ~ 15,000 | —— |
| | 4000V | 5.0 ~ 560 | 2,200 ~ 6,800 | —— |
| | 5000V | 5.0 ~ 120 | —— | —— |
| 3012 | 100V | 5.0 ~ 27,000 | 150 ~ 3,300,000 | 15,000 ~ 1,500,000 |
| | 200V | 5.0 ~ 12,000 | 150 ~ 2,200,000 | 15,000 ~ 1,000,000 |
| | 250V | 5.0 ~ 12,000 | 150 ~ 1,200,000 | —— |
| | 500V | 5.0 ~ 6,800 | 150 ~ 220,000 | —— |
| | 630V | 5.0 ~ 6,800 | 150 ~ 150,000 | —— |
| | 1000V | 5.0 ~ 3,900 | 150 ~ 47,000 | —— |
| | 2000V | 5.0 ~ 1,000 | 150 ~ 33,000 | —— |
| | 3000V | 5.0 ~ 1,000 | 150~10,000 | —— |
| | 4000V | 5.0 ~ 1,000 | 150~8,200 | —— |
| | 5000V | 5.0 ~ 120 | —— | —— |
| 3035 | 100V | 5.0 ~ 27,000 | 47,000 ~ 4,700,000 | 10,000 ~ 2,200,000 |
| | 200V | 5.0 ~ 12,000 | 47,000 ~ 2,200,000 | 10,000 ~ 2,200,000 |
| | 250V | 5.0 ~ 12,000 | 47,000 ~ 2,200,000 | 10,000 ~ 2,200,000 |
| | 500V | 5.0 ~ 6,800 | 5,600 ~ 1,000,000 | —— |
| | 630V | 5.0 ~ 6,800 | 5,600 ~ 470,000 | —— |
| | 1000V | 5.0 ~ 3,900 | 5,600 ~ 56,000 | —— |
| | 2000V | 5.0 ~ 1,000 | 5,600 ~ 47,000 | —— |
| | 5000V | 5.0 ~ 120 | —— | —— |

备注：可根据客户的特殊要求设计符合客户需求的产品。

Note：We can design according to customer special requirements.



中高压电容器介质耐电强度的测试方法：

Measurement method of dielectric withstanding voltage for high voltage MLCC

| 额定电压范围 Rated voltage range | 耐电性能的测试方法 Measuring Method |
|-------------------------------|--|
| 100V Vr < 500V | 施加额定电压的 200%，5 秒，最大电流不超过 50mA Force 200% Rated voltage for 5 second. Max..current should not exceed 50 mA. |
| 500V Vr 1000V | 施加额定电压的 150%，5 秒，最大电流不超过 50mA Force 150% Rated voltage for 5 second. Max..current should not exceed 50 mA. |
| 1000V < Vr 2000V | 施加额定电压的 120%，5 秒，最大电流不超过 50mA Force 120% Rated voltage for 5 seconds. Max..current should not exceed 50 mA. |
| 2000V < Vr 5000V | 施加额定电压的 120%，5 秒，最大电流不超过 10mA Force 120% Rated voltage for 5 seconds. Max..current should not exceed 10 mA. |

八、可靠性测试 Reliability Test

| 项目 Item | 技术规格 Technical Specification | | 测试方法 Test Method and Remarks | | |
|---|---------------------------------|---|--|-----------------------------|---------------------------|
| 容量 Capacitance | 类 Class | 应符合指定的误差级别 Should be within the specified tolerance. | 标称容量 Capacitance | 测试频率 Measuring Frequency | 测试电压 Measuring Voltage |
| | 类 Class | 应符合指定的误差级别 Should be within the specified tolerance. | 1000pF > 1000 pF | 1MHZ ± 10% 1KHZ ± 10% | 1.0 ± 0.2Vrms |
| | | | 测试温度：25 ± 3 Test Temperature: 25 ± 3 C 10μF：测试频率：1KHZ ± 10% 测试电压：1.0 ± 0.2Vrms Test Frequency: 1KHZ ± 10% Test Voltage: 1.0 ± 0.2Vrms C > 10μF X7R、X5R、X7S、X6S、Y5V： 测试频率：120 ± 24 HZ 测试电压：0.5 ± 0.1Vrms Test Frequency: 120 ± 24 HZ Test Voltage: 0.5 ± 0.1Vrms Z5U：测试频率：1 ± 0.1KHZ 测试电压：0.5 ± 0.05Vrms Test Frequency: 1 ± 0.1KHZ Test Voltage: 0.5 ± 0.05Vrms | | |
| 损耗角正切 (DF, tan) Dissipation Factor | 类 Class | DF | 标称容量 Capacitance | 测试频率 Measuring Frequency | 测试电压 Measuring Voltage |
| | | 0.56% | Cr < 5 pF | 1MHZ ± 10% | 1.0 ± 0.2Vrms |
| | | $1.5[(150/Cr)+7] \times 10^{-4}$ | 5pF Cr < 50 pF | 1MHZ ± 10% | |
| | | 0.15% | 50pF Cr 1000 pF | 1MHZ ± 10% | |
| 0.15% | > 1000 pF | 1KHZ ± 10% | | | |



| 项目 Item | 技术规格 Technical Specification | | | | | | | 测试方法 Test Method and Remarks | | |
|--|--|--|---|---|---|---|---|--|--|--|
| 损耗角正切(DF, tan) Dissipation Factor | 类 Class | X7R/ X5R | 50V | 25V | 16V | 10V | 6.3V | C < 10μF 测试频率: 1KHZ ± 10% 测试电压: 1.0 ± 0.2Vrms Test Frequency: 1KHZ ± 10% Test Voltage: 1.0 ± 0.2Vrms C > 10μF X7R、X5R、X7S、X6S、Y5V 测试频率: 120 ± 24 HZ 测试电压: 0.5 ± 0.1Vrms Test Frequency: 120 ± 24HZ Test Voltage: 0.5 ± 0.1Vrms Z5U:测试频率: 1 ± 0.1KHZ 测试电压: 0.5 ± 0.05Vrms Test Frequency: 1 ± 0.1KHZ Test Voltage: 0.5 ± 0.05Vrms | | |
| | | X7S/ X6S (0402) | 2.5% | 3.5% (C < 0.47μF) 100% (C < 0.47μF) | 3.5% (C < 0.47μF) 100% (C < 0.47μF) | 5.0% (C < 0.15μF) 100% (C < 0.15μF) | 5.0% (C < 0.15μF) 100% (C < 0.15μF) | | | |
| | X7R/ X5R | 50V | 25V | 16V | 10V | 6.3V | | | | |
| | X7S/ X6S (< 0402) | 3.5% | 5.0% (C < 0.047μF) 10% (C > 0.047μF) | 5.0% (C < 0.047μF) 10% (C > 0.047μF) | 7.5% (C < 0.047μF) 10% (C > 0.047μF) | 7.5% (C < 0.047μF) 10% (C > 0.047μF) | 7.5% (C < 0.047μF) 10% (C > 0.047μF) | | | |
| | | Y5V Z5U | | 25V 7.0% (C < 1.0μF) 9.0% (C < 1.0μF) | 16V 15% | 10V 15% | 6.3V 15% | | | |
| 绝缘电阻 (IR) Insulation Resistance | 类 Class | C < 10 nF, Ri 50000M C > 10 nF, Ri C _R 500S | | | | | | | 测试电压: 额定电压 (最高 500V) 测试时间: 60 ± 5 秒 测试湿度: 75% 测试温度: 25 ± 3 测试充放电电流: 50mA Measuring Voltage: Rated Voltage (Max 500V) Duration: 60 ± 5s Test Humidity: 75% Test Temperature: 25 ± 5 Test Current: 50mA | |
| | 类 Class | X7R/ X5R/ X7S/ X6S | C < 25 nF, Ri 10000M C > 25 nF, Ri C _R > 100S | | | | | | | |
| | Y5V Z5U | C < 25 nF, Ri 4000M C > 25 nF, Ri C _R > 100S | | | | | | | | |
| 介质耐电强度(DWV) Dielectric Withstanding Voltage | 不应有介质被击穿或损伤 No breakdown or damage. | | | | | | | 测量电压: 类:300%额定电压 类:250%额定电压 时间: 1 ~ 5 秒 充/放电电流: 不应超过 50mA (这部分说明不包括中高压 MLCC) Measuring Voltage: Class :300% Rated voltage Class :250% Rated voltage Duration: 1 ~ 5s Charge/ Discharge Current: 50mA max. (This method excludes high-voltage MLCC) | | |



| 项目 Item | 技术规格 Technical Specification | | | | 测试方法 Test Method and Remarks |
|--|--|--|---|--------------|--|
| 可焊性 Solderability | 上锡率应大于 95% 外观：无可见损伤。 At least 95% of the terminal electrode is covered by new solder. Visual Appearance: No visible damage. | | | | 将电容在 80~120 的温度下预热 10~30 秒。 Preheating conditions: 80 to 120 ; 10~30s. |
| | 有铅焊料: (Sn/Pb : 63/37) 浸锡温度: 235 ± 5 浸锡时间: 2 ± 0.5s Solder Temperature: 235 ± 5 Duration: 2 ± 0.5s | | 无铅焊料: 浸锡温度: 245 ± 5 浸锡时间: 2 ± 0.5s Solder Temperature: 245 ± 5 Duration: 2 ± 0.5s | | |
| 耐焊热 Resistance to Soldering Heat | 项目 Item | NPO 至 SL NPO to SL | X7R/X5R/ X7S/X6S | Y5V、 Z5U | 将电容在 100~200 的温度下预热 10 ± 2 分钟。 浸锡温度: 265 ± 5 浸锡时间: 10 ± 1s 然后取出溶剂清洗干净，在 10 倍以上的显微镜底下观察。 放置时间：24 ± 2 小时 放置条件：室温 Preheating conditions: 100 to 200 ; 10 ± 2min. Solder Temperature: 265 ± 5 Duration: 10 ± 1s Clean the capacitor with solvent and examine it with a 10X(min.) microscope. Recovery Time: 24 ± 2h Recovery condition: Room temperature |
| | CC | ± 0.5% 或 ± 0.5PF, 取较大值 ± 0.5% or ± 0.5PF whichever is larger | -5~+10% | -10~+2 0% | |
| | DF | 同初始标准 Same to initial value. | | | |
| | IR | 同初始标准 Same to initial value. | | | |
| | 外观：无可见损伤 上锡率： 95% Appearance :No visible damage. At least 95% of the terminal electrode is covered by new solder. | | | | |
| 抗弯曲强度 Resistance to Flexure of Substrate (Bending Strength) | 外观：无可见损伤。 Appearance: No visible damage. | | | | 试验基板：Al ₂ O ₃ 或 PCB 弯曲深度：1mm 施压速度：0.5mm/sec. 单位：mm 应在弯曲状态下进行测量。  |
| | C/C | ± 10% | | | Test Board: Al ₂ O ₃ or PCB Warp: 1mm Speed: 0.5mm/sec. Unit: mm The measurement should be made with the board in the bending position. |



| 项目 Item | 技术规格 Technical Specification | 测试方法 Test Method and Remarks | | | | | | | | | | | | | | | | | | | | | | | | | | | | | | |
|--|---|--|---|--------|--------|-----|---|----|-----|----------|-------|-----|---|----|-----|----------|-------|------|-----------------|-------------|---|---|----|---|--------------------|-------|---|--|----|---|--------------------|-------|
| 端头结合强度 Termination Adhesion | 外观无可见损伤 No visible damage. | 施加的力：5N 时间：10 ± 1S Applied Force: 5N Duration: 10 ± 1S | | | | | | | | | | | | | | | | | | | | | | | | | | | | | | |
| 温度循环 Temperature Cycle | <p>C/C: 类： ± 1% 或 ± 1pF , 取两者中最大者 类： B,X,BS,DS: ± 10% E,F: ± 20%</p> <p>Class : ± 1% or ± 1pF, whichever is larger. Class : B,X,BS,DS: ± 10% E,F: ± 20%</p> | <p>预处理 (2类): 上限类别温度, 1小时 恢复：24 ± 1h 初始测量 循环次数：5次，一个循环分以下4步：</p> <table border="1"> <thead> <tr> <th>阶段</th> <th>温度 ()</th> <th>时间(分钟)</th> </tr> </thead> <tbody> <tr> <td>第1步</td> <td>下限温度^(NPO/X7R/X7S/X6S/X5R:-55 Y5V:-25 Z5U:+10)</td> <td>30</td> </tr> <tr> <td>第2步</td> <td>常温 (+20)</td> <td>2 ~ 3</td> </tr> <tr> <td>第3步</td> <td>上限温度^(NPO/X7R/X7S: Y5V/Z5U/X5R:+85 X6S:+105)</td> <td>30</td> </tr> <tr> <td>第4步</td> <td>常温 (+20)</td> <td>2 ~ 3</td> </tr> </tbody> </table> <p>试验后放置 (恢复) 时间：24 ± 2h Preheating conditions: up-category temperature, 1h Recovery time: 24 ± 1h Initial Measurement Cycling Times: 5 times, 1 cycle, 4 steps:</p> <table border="1"> <thead> <tr> <th>Step</th> <th>Temperature ()</th> <th>Time (min.)</th> </tr> </thead> <tbody> <tr> <td>1</td> <td>Low-category temp. ^(NPO/X7R/X7S/X6S/X5R:-55 Y5V:-25 Z5U:+10)</td> <td>30</td> </tr> <tr> <td>2</td> <td>Normal temp. (+20)</td> <td>2 ~ 3</td> </tr> <tr> <td>3</td> <td>Up-category temp. ^(NPO/X7R/X7S: Y5V/Z5U/X5R:+85 X6S:+105)</td> <td>30</td> </tr> <tr> <td>4</td> <td>Normal temp. (+20)</td> <td>2 ~ 3</td> </tr> </tbody> </table> <p>Recovery time after test: 24 ± 2h</p> | 阶段 | 温度 () | 时间(分钟) | 第1步 | 下限温度 ^(NPO/X7R/X7S/X6S/X5R:-55 Y5V:-25 Z5U:+10) | 30 | 第2步 | 常温 (+20) | 2 ~ 3 | 第3步 | 上限温度 ^(NPO/X7R/X7S: Y5V/Z5U/X5R:+85 X6S:+105) | 30 | 第4步 | 常温 (+20) | 2 ~ 3 | Step | Temperature () | Time (min.) | 1 | Low-category temp. ^(NPO/X7R/X7S/X6S/X5R:-55 Y5V:-25 Z5U:+10) | 30 | 2 | Normal temp. (+20) | 2 ~ 3 | 3 | Up-category temp. ^(NPO/X7R/X7S: Y5V/Z5U/X5R:+85 X6S:+105) | 30 | 4 | Normal temp. (+20) | 2 ~ 3 |
| 阶段 | 温度 () | 时间(分钟) | | | | | | | | | | | | | | | | | | | | | | | | | | | | | | |
| 第1步 | 下限温度 ^(NPO/X7R/X7S/X6S/X5R:-55 Y5V:-25 Z5U:+10) | 30 | | | | | | | | | | | | | | | | | | | | | | | | | | | | | | |
| 第2步 | 常温 (+20) | 2 ~ 3 | | | | | | | | | | | | | | | | | | | | | | | | | | | | | | |
| 第3步 | 上限温度 ^(NPO/X7R/X7S: Y5V/Z5U/X5R:+85 X6S:+105) | 30 | | | | | | | | | | | | | | | | | | | | | | | | | | | | | | |
| 第4步 | 常温 (+20) | 2 ~ 3 | | | | | | | | | | | | | | | | | | | | | | | | | | | | | | |
| Step | Temperature () | Time (min.) | | | | | | | | | | | | | | | | | | | | | | | | | | | | | | |
| 1 | Low-category temp. ^(NPO/X7R/X7S/X6S/X5R:-55 Y5V:-25 Z5U:+10) | 30 | | | | | | | | | | | | | | | | | | | | | | | | | | | | | | |
| 2 | Normal temp. (+20) | 2 ~ 3 | | | | | | | | | | | | | | | | | | | | | | | | | | | | | | |
| 3 | Up-category temp. ^(NPO/X7R/X7S: Y5V/Z5U/X5R:+85 X6S:+105) | 30 | | | | | | | | | | | | | | | | | | | | | | | | | | | | | | |
| 4 | Normal temp. (+20) | 2 ~ 3 | | | | | | | | | | | | | | | | | | | | | | | | | | | | | | |
| 潮湿试验 Moisture Resistance | C/C | <p>类： ± 2% 或 ± 1pF, 取两者之中较大者 类: B,X,BS,DS: ± 10% E,F: ± 30%</p> <p>Class : ± 2% or ± 1pF, whichever is larger. Class : B,X,BS,DS: ± 10% E,F: ± 30%</p> | <p>温度：40 ± 2 湿度：90~95%RH 时间：500小时 放置条件：室温 放置时间：24小时(类)；48小时(类) Temperature：40 ± 2 Humidity：90~95%RH Duration：500h Recovery conditions：Room temperature Recovery Time：24h (Class1) or 48h (Class2)</p> | | | | | | | | | | | | | | | | | | | | | | | | | | | | | |
| | DF | 2倍初始标准 Not more than twice of initial value. | | | | | | | | | | | | | | | | | | | | | | | | | | | | | | |
| | IR | 类：Ri 2500M 或 Ri C _R 25S 取两者之中较小者。 Class：Ri 2500M 或 Ri C _R 25S whichever is smaller. | | | | | | | | | | | | | | | | | | | | | | | | | | | | | | |
| | | 类：Ri 1000M 或 Ri C _R 25S 取两者之中较小者。 Class：Ri 1000M 或 Ri C _R 25S whichever is smaller. | | | | | | | | | | | | | | | | | | | | | | | | | | | | | | |
| 外观：无损伤 Appearance: No visible damage. | | | | | | | | | | | | | | | | | | | | | | | | | | | | | | | | |



| 项目 Item | 技术规格 Technical Specification | | 测试方法 Test Method and Remarks |
|--|---------------------------------|--|--|
| 寿命试验 Life Test | C/C | 类：±2%或±1pF 取两者之中较大者 类：B,X,BS,DS: ±20% E,F: ±30% Class : ±2% or ±1pF, whichever is larger. Class : B,X,BS,DS: ±20% E,F: ±30% | 低压产品 (100V) 电压：1.5 倍额定工作电压 时间：1000 小时 温度：125 (NPO、X7R、X7S) 85 (X5R、Y5V) 105 (X6S) 充电电流：不应超过 50mA 放置条件：室温 放置时间：24 小时 (类), 或 48 小时 (类), Low-Voltage (100V) Applied Voltage: 1.5 × Rated Voltage Duration: 1000h Temperature : 125 (NPO、X7R、X7S) 85 (X5R、Y5V) 105 (X6S) Charge/ Discharge Current: 50mA max. Recovery Conditions: Room Temperature Recovery Time: 24h (Class 1), or 48h (Class2) |
| | | DF | |
| | IR | 类：Ri 4000M 或 Ri C _R 40S 取两者之中较小者。 Class : Ri 4000M 或 Ri C _R 40S whichever is smaller. | |
| | | 类：Ri 2000M 或 Ri C _R 50S 取两者之中较小者。 Class : Ri 2000M 或 Ri C _R 50S whichever is smaller. | |
| 外观：无损伤 Visual Appearance: No visible damage. | | | |
| 中高压产品 寿命试验 Middle & high voltage Life Test | C/C | 类：±2%或±1pF 取两者之中较大者 类：B,X,BS,DS: ±20% E,F: ±30% Class : ±2% or ±1pF, whichever is larger. Class : B,X,BS,DS: ±20% E,F: ±30% | 中高压产品： 100V 额定电压 < 500V：2 倍工作电压 500V 额定电压 1000V：1.5 倍工作电压 额定电压 > 1000V：1.2 倍工作电压 时间：1000 小时 充电电流：不应超过 50mA 温度：125 (NPO X7R、X7S); 85 (X5R、Y5V) 105 (X6S) 放置条件：室温 放置时间：24 小时 (类), 或 48 小时 (类), Applied Voltage: 100V Rated Voltage < 500V：2 Multiple 500V Rated Voltage 1000V：1.5 Multiple > 1000V Rated Voltage：1.2 Multiple Duration: 1000h Charge/ Discharge Current: 50mA max. Temperature : 125 (NPO X7R、X7S); 85 (X5R、Y5V) 105 (X6S) Recovery Conditions: Room Temperature Recovery Time: 24h (Class 1), or 48h (Class2) |
| | | DF | |
| | IR | 类：Ri 4000M 或 Ri C _R 40S 取两者之中较小者。 Class : Ri 4000M 或 Ri C _R 40S whichever is smaller. | |
| | | 类：Ri 2000M 或 Ri C _R 50S 取两者之中较小者。 Class : Ri 2000M 或 Ri C _R 50S whichever is smaller. | |
| 外观：无损伤 Visual Appearance: No visible damage. | | | |

注解：

专门预处理（仅对 2 类电容器）：

将电容器放在上限类别温度或按详细规范中可能规定的更高温度下经 1h 后，接着在试验的标准大气条件下恢复 24 ± 1h。

Note : Pretreatment (only for class2 capacitor)

Pretreatment (only for class2 capacitor) is a method to treat the capacitor before measurement. First, place the capacitor in the up-category temperature or other specified higher temperature environment for 1hour. Then recovery the capacitor at standard pressure conditions for 24 ± 1hours.

九、包装 PACKAGE

纸带卷盘结构 PAPER TAPING

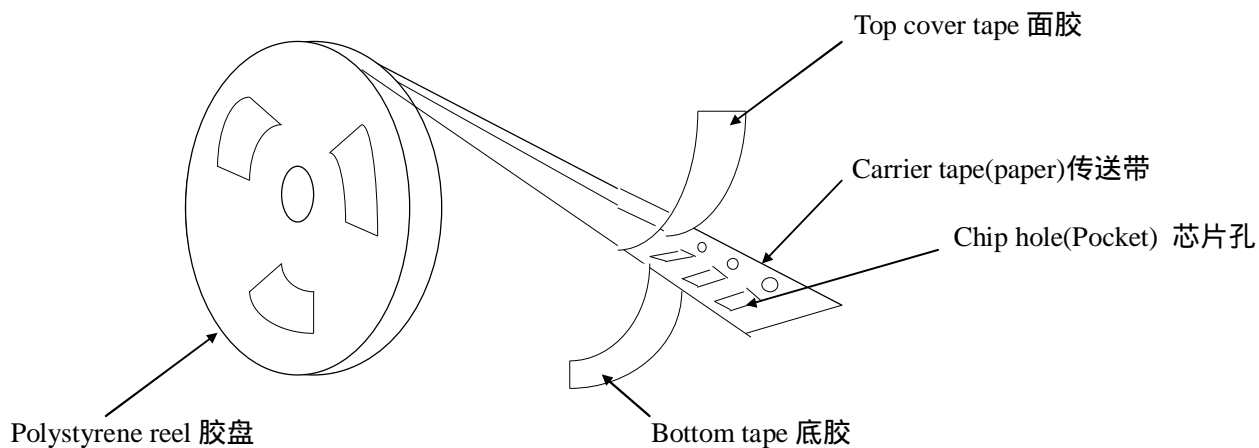

0201、0402 纸带编带尺寸大小

Dimensions of paper taping for 0402 type

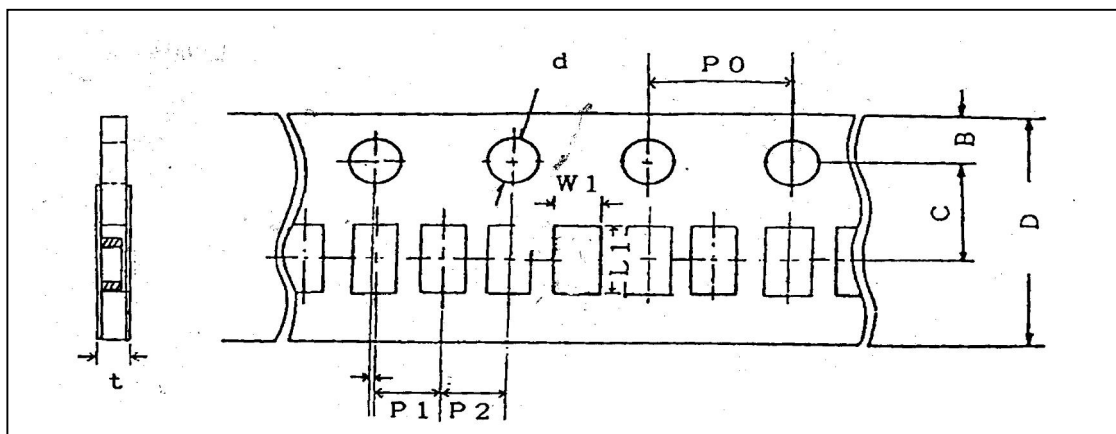

| 代号 Code | W1 | L1 | D | C | B | P1 | P2 | P0 | d | t |
|------------|---------------|---------------|---------------|---------------|---------------|---------------|---------------|---------------|------------------|---------------|
| 0201 | 0.37± 0.10 | 0.67± 0.10 | 8.00± 0.10 | 3.50± 0.05 | 1.75± 0.10 | 2.00± 0.05 | 2.00± 0.05 | 4.00± 0.10 | 1.50 -0/+0.10 | 0.80 Below |
| 0402 | 0.65± 0.10 | 1.15± 0.10 | 8.00± 0.10 | 3.50± 0.05 | 1.75± 0.10 | 2.00± 0.05 | 2.00± 0.05 | 4.00± 0.10 | 1.50 -0/+0.10 | 0.80 Below |

适合 '0603, 0805, 1206' 常规尺寸产品的纸带尺寸

Dimensions of paper taping for 0603, 0805, 1206 types.

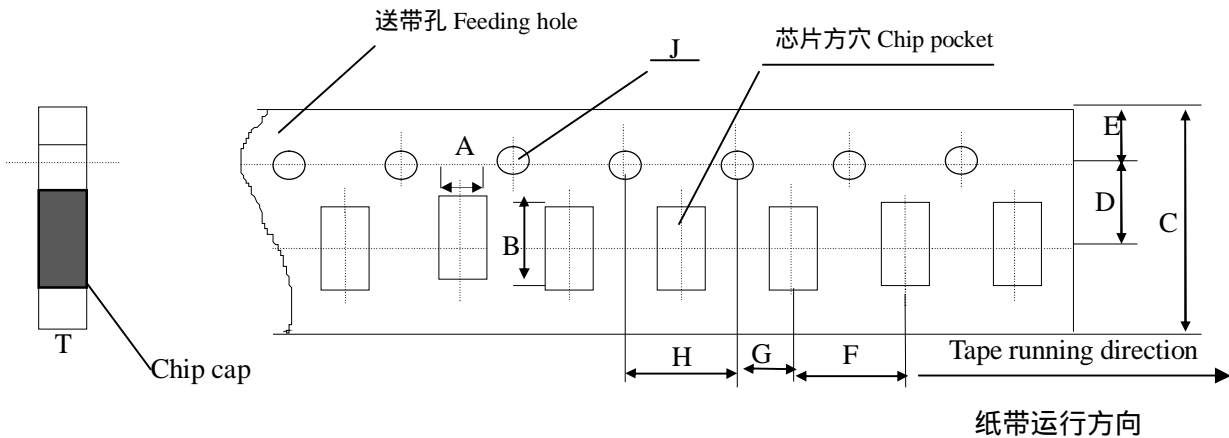

Unit : mm

| 代号 Code 纸带规格 paper size | A | B | C | D* | E | F | G* | H | J | T |
|-------------------------------|---------------|---------------|---------------|---------------|---------------|---------------|---------------|---------------|------------------|-------------|
| 0603 | 1.10 ±0.10 | 1.90 ±0.10 | 8.00 ±0.10 | 3.50 ±0.05 | 1.75 ±0.10 | 4.00 ±0.10 | 2.00 ±0.10 | 4.00 ±0.10 | 1.50 -0/+0.10 | 1.10 Max |
| 0805 | 1.45 ±0.15 | 2.30 ±0.15 | 8.00 ±0.15 | 3.50 ±0.05 | 1.75 ±0.10 | 4.00 ±0.10 | 2.00 ±0.10 | 4.00 ±0.10 | 1.50 -0/+0.10 | 1.10 Max |
| 1206 | 1.80 ±0.20 | 3.40 ±0.20 | 8.00 ±0.20 | 3.50 ±0.05 | 1.75 ±0.10 | 4.00 ±0.10 | 2.00 ±0.10 | 4.00 ±0.10 | 1.50 -0/+0.10 | 1.10 Max |

注意：*表示此处对尺寸的要求非常精确。

Note: The place with "*" means where needs exactly dimensions.

塑胶卷盘结构 EMBOSED TAPING



塑胶带尺寸结构(适合 ' 0805~1812 ' 型产品)

Dimensions of embossed taping for 0805~1812 type

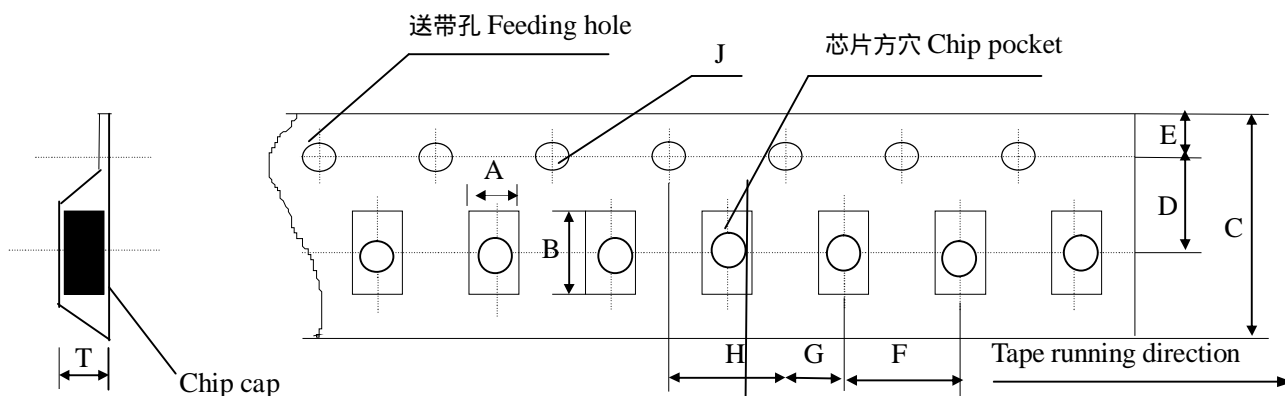

塑胶带传送方向

| 代号 Code | A | B | C | D* | E | F | G* | H | J | T |
|-----------------|---------------|---------------|----------------|---------------|---------------|---------------|---------------|---------------|------------------|-------------|
| 规格 Tape size | | | | | | | | | | |
| 0805 | 1.55 ±0.20 | 2.35 ±0.20 | 8.00 ±0.20 | 3.50 ±0.05 | 1.75 ±0.10 | 4.00 ±0.10 | 2.00 ±0.10 | 4.00 ±0.10 | 1.50 -0/+0.10 | 1.50 Max |
| 1206 | 1.95 ±0.20 | 3.60 ±0.20 | 8.00 ±0.20 | 3.50 ±0.05 | 1.75 ±0.10 | 4.00 ±0.10 | 2.00 ±0.10 | 4.00 ±0.1 | 1.50 -0/+0.10 | 1.85 Max |
| 1210 | 2.70 ±0.10 | 3.42 ±0.10 | 8.00 ±0.10 | 3.50 ±0.05 | 1.75 ±0.10 | 4.00 ±0.10 | 2.00 ±0.05 | 4.00 ±0.10 | 1.55 -0/+0.10 | 3.2 Max |
| 1808 | 2.20 ±0.10 | 4.95 ±0.10 | 12.00 ±0.10 | 5.50 ±0.05 | 1.75 ±0.10 | 4.00 ±0.10 | 2.00 ±0.05 | 4.00 ±0.10 | 1.50 -0/+0.10 | 3.0 Max |
| 1812 | 3.66 ±0.10 | 4.95 ±0.10 | 12.00 ±0.10 | 5.50 ±0.05 | 1.75 ±0.10 | 8.00 ±0.10 | 2.00 ±0.05 | 4.00 ±0.10 | 1.55 -0/+0.10 | 4.0 Max |

备注：*表示此处对尺寸的要求非常精确。

Note: The place with "*" means where needs exactly dimensions.

传送带的前后结构 Structure of leader part and end part of the carrier paper



卷盘尺寸 Reel Dimensions (unit: mm)



尺寸代码 (CODE)

| 卷盘型号 | A | B | C | D | E | F | G |
|---------|--------|-----|--------|--------|----------------------|---------|-------|
| 7 REEL | 178±20 | 3.0 | 13±0.5 | 21±0.8 | 50 或更大 50 or more | 100±1.5 | 12max |
| 13 REEL | 330±20 | 3.0 | 13±0.5 | 21±0.8 | 50 或更大 50 or more | 100±1.5 | 12max |

关于卷带的说明 Taping specification

面胶剥离强度 Top tape peeling strength

(a) 纸带 Paper Taping

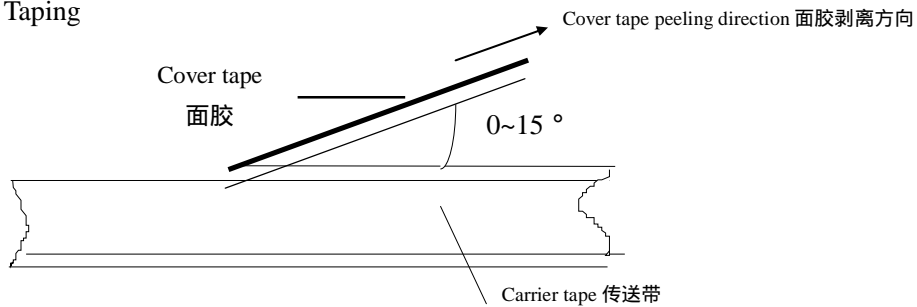

(b) 塑料胶盘 Embossed Taping



标准：0.1N<剥离强度<0.7N

Standard: 0.1N < peeling strength < 0.7N

在剥离时，纸带不能有纸碎，也不能粘在底、面胶上。

No paper dirty remains on the scotch when peeling, and sticks to top and bottom tape.



塑料盒散包装 Bulk Case Package

单位 (unit) :mm

| | | | | | | |
|-----------|---------------|---------------|--------------|---------------|---------------|-------------|
| Symbol | A | B | T | C | D | E |
| Dimension | 6.80 ± 0.10 | 8.80 ± 1.00 | 12.00 ± 0.10 | 15.00+0.10/-0 | 2.00+0/-0.10 | 4.70 ± 0.10 |
| Symbol | F | W | G | H | L | I |
| Dimension | 31.50+0.20/-0 | 36.00+0/-0.20 | 19.00 ± 0.35 | 7.00 ± 0.35 | 110.00 ± 0.70 | 5.00 ± 0.35 |

包装数量 Packing Quantity

| 尺寸 (SIZE) | 包装形式和数量 (PACKAGE STYLE & QUANTITY) unit: pcs | | | |
|----------------------------------|---|----------------------------------|--------------|-------------|
| | 纸带卷盘 (PT) | 胶带卷盘 (ET) | 塑料盒散装 (BC) | 一般散装 (BP) |
| 0201 | 15000 | ----- | 20000 | 5000 |
| 0402 | 10000 | ----- | 20000 | 5000 |
| 0603 | 4000 | ----- | 15000 | 5000 |
| 0805 | 4000 | 3000 | 10000 | 5000 |
| 1206 | 4000 | T 1.35mm 3000 T > 1.35mm 2000 | 5000 | 5000 |
| 1210 | ----- | T 1.80mm 2000 T > 1.80mm 1000 | ----- | 2000 |
| 1410 | ----- | 2000 | ----- | ----- |
| 1808 | ----- | 2000 | ----- | 2000 |
| 1812 | ----- | T 1.85mm 1000 T > 1.85mm 500 | ----- | 2000 |
| 1825、2220、 2025、2225、 3035 | ----- | 500 | ----- | 500 |

注意：包装的形式和数量可根据客户的要求来定。

Note : We can choose packing style and quantity can be according to the customer's requirement.



外包装 Outer packing

小包装 The first package

Quantity: 10 reels

数量：10卷

大包装 The second package

Quantity: 6 cases

数量：6盒



十、储存方法 Storage Methods

确保芯片可焊性良好的贮存期限为 6 个月(在包装好已交付的情况下)。

The guaranteed period for solderability is 6 months (Under deliver package condition).

储存条件/Storage conditions :

储存温度/Temperature 5~40

储存相对湿度/Relative Humidity 20~70%

十一、使用前的注意事项 Precautions For Use

多层片式瓷介电容器(MLCC)在短路或开路的电路中都有可能失效,在超出本承认书或相关说明书中所述使用频率的恶劣工作环境,或外界机械力超压作用下,电容芯片都有可能着火、燃烧甚至爆炸,所以在使用的時候,首先应考虑按本承认书的有关说明来进行,如有不明之处,请联系我们技术部、品管部或生产部。

The Multi-layer Ceramic Capacitors (MLCC) may fail in a short circuit modern in an open circuit mode when subjected to severe conditions of electrical environment and / or mechanical stress beyond the specified “rating” and specified “conditions” in the specification, which will result in burn out, flaming or glowing in the worst case. Following “precautions for “safety” and Application Notes shall be taken in your major consideration. If you have a question about the precautions for handling, please contact our engineering section or factory.

1. 焊接的条件与相关图表 Soldering Profile

为避免因温度的突然变化而引起的芯片开裂或局部爆炸的现象发生,请按有关温度曲线图表来进行。(请参考附页中的图表)

To avoid the crack problem by sudden temperature change, follow the temperature profile in the adjacent graph (refer to the graph in the enclosure page).



2. 手工焊接 Manual Soldering

手工焊接很容易因为芯片局部受热不均而引起瓷体微裂或局部爆炸的现象,在焊接时,如果操作者不小心,会使烙铁头直接同电容芯片的瓷体部分接触,这样很容易使电容芯片因热冲击而受损或出现其他意外.因此,使用电烙铁手工焊接时应仔细操作,并对电烙铁的尖端的选择和尖端温度控制应多加小心.

Manual soldering can pose a great risk of creating thermal cracks in capacitors. The hot soldering iron tip comes into direct contact with the end terminations, and operator's careless may cause the tip of the soldering iron to come into direct contact with the ceramic body of the capacitor. Therefore the soldering iron must be handled carefully, and pay much attention to the selection of the soldering iron tip and temperature contact of the tip.

3. 适量的焊料 Optimum Solder Amount for Reflow Soldering

焊料过多
Too much solder



这样会因端头压力过大而可能引起芯片受损
Cracks tend to occur due to large stress.

焊料太少
Not enough solder



固定力量不足,可能会引起电容芯片与线路接触不良
Weak holding force may cause bad connection between the capacitor and PCB.

4. 推荐焊料用量 Recommended Soldering amounts

4.1 回流焊接的最佳焊料用量

The optimal solder fillet amounts for re-flow soldering



4.2 波峰焊接的最佳焊料用量

The optimal solder fillet amounts for wave soldering



4.3 使用烙铁返修时的最佳焊料量

The optimal solder fillet amounts for reworking by using soldering iron

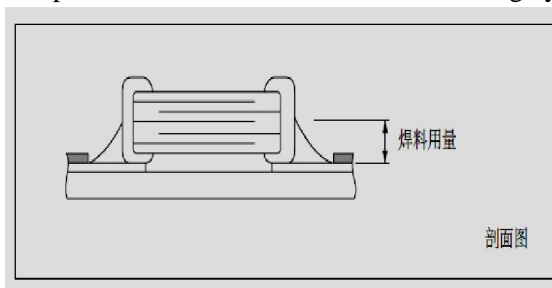



十二、推荐焊接方式 Recommended Soldering Method

| 规格尺寸 Size | 温度特性 Temperature Characteristics | 额定电压 Rated Voltage | 容量范围 Capacitance | 焊接方式 Soldering Method |
|--------------|-------------------------------------|-----------------------|---------------------|--------------------------|
| 0201 | NPO | / | | R |
| | X7R/X5R/X7S/X6S | / | | R |
| | Y5V | / | | R |
| 0402 | NPO | / | | R |
| | X7R/X5R/X7S/X6S | / | | R |
| | Y5V | / | | R |
| 0603 | NPO | / | | R/W |
| | X7R/X5R/X7S/X6S | / | C 1uf | R |
| | | | C < 1uf | R/W |
| | Y5V | / | C 1uf | R |
| | | | C < 1uf | R/W |
| 0805 | NPO | / | / | R/W |
| | X7R/X5R/X7S/X6S | / | C 4.7uf | R |
| | | | C < 4.7uf | R/W |
| | Y5V | / | C 1uf | R |
| | | | C < 1uf | R/W |
| 1206 | NPO | / | / | R/W |
| | X7R/X5R/X7S/X6S | / | C 10uf | R |
| | | | C < 10uf | R/W |
| | Y5V | / | C 10uf | R |
| | | | C < 10uf | R/W |
| 1210 | NPO | / | / | R |
| | X7R/X5R/X7S/X6S | / | / | R |
| | Y5V | / | / | R |

焊接方式 Soldering method : R—回流焊 Reflow Solering

W—波峰焊 Wave Soldering



十三、推荐焊接温度曲线图 The temperature profile for soldering

回流焊接 (Re-flow soldering)

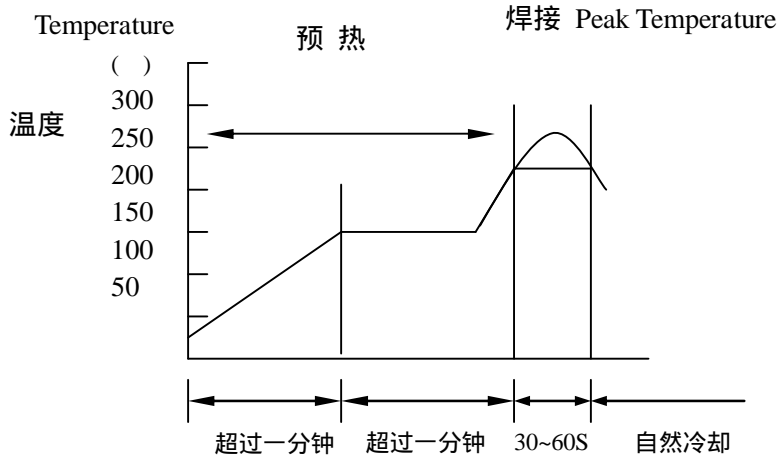

| | Pb-Sn 焊接 Pb-Sn soldering | 无铅焊接 Lead-free soldering |
|--------------------------|-----------------------------|-----------------------------|
| 尖峰温度 Peak temperature | 230 ~ 250 | 240 ~ 260 |

在预热时，请将焊接温度与芯片表面温度之间的温差维持在 T 150 。

While in preheating, please keep the temperature difference between soldering temperature and surface temperature of chips as: T 150 .

波峰焊接 (Wave soldering)



| | Pb-Sn 焊接 Pb-Sn soldering | 无铅焊接 Lead-free soldering |
|--------------------------|-----------------------------|-----------------------------|
| 尖峰温度 Peak temperature | 230 ~ 260 | 240 ~ 270 |

在预热时，请将焊接温度与芯片表面温度之间的温差维持在 T 150 。

While in preheating, please keep the temperature difference between soldering temperature and surface temperature of chips as: T 150 .



手工焊接 (Hand soldering)

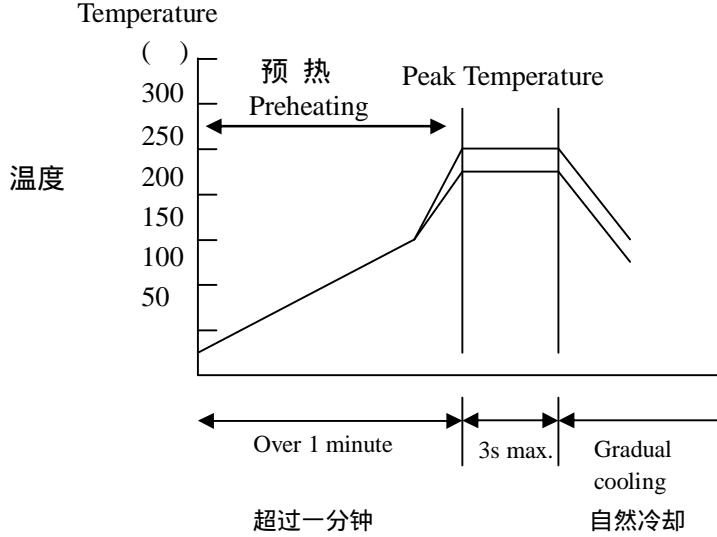

条件 Conditions :

| 预热 Preheating | 烙铁头温度 Temperature of soldering iron head | 烙铁功率 Power of soldering iron | 烙铁头直径 Diameter of soldering iron head | 焊接时间 Soldering time | 锡膏量 Solder paste amount | 限制条件 Restricted conditions |
|------------------|--|------------------------------------|--|------------------------------|-----------------------------------|---|
| 130 | 最高300 Highest temperature:300 | 最大20W 20W at the highest | 建议1mm 1mm recommended | 最长3s 3s at the longest | 1/2 芯片厚度 1/2 chip thickness | 请勿使用烙铁头直接接触陶瓷元件 Please avoid the direct contact between soldering iron head and ceramic components |

以最新版本的内容为准

X-ON Electronics

Largest Supplier of Electrical and Electronic Components

Click to view similar products for [Multilayer Ceramic Capacitors MLCC - SMD/SMT](#) category:

Click to view products by [Fenghua Advanced](#) manufacturer:

Other Similar products are found below :

[M39014/01-1467](#) [M39014/02-1218V](#) [M39014/02-1225V](#) [M39014/02-1262V](#) [M39014/02-1301](#) [M39014/22-0631](#) [1210J5000102JCT](#)
[1210J2K00102KXT](#) [1210J5000103KXT](#) [1210J5000223KXT](#) [D55342E07B379BR-TR](#) [D55342E07B523DR-T/R](#) [1812J1K00103KXT](#)
[1812J1K00473KXT](#) [1812J2K00680JCT](#) [1812J4K00102MXT](#) [1812J5000102JCT](#) [1812J5000103JCT](#) [1812J5000682JCT](#) [NIN-FB391JTRF](#)
[NIN-FC2R7JTRF](#) [NPIS27H102MTRF](#) [C1206C101J1GAC](#) [C1608C0G1E472JT000N](#) [C2012C0G2A472J](#) [2220J2K00101JCT](#)
[KHC201E225M76N0T00](#) [LRC-LRF1206LF-01R025FTR1K](#) [1812J1K00222JCT](#) [1812J2K00102KXT](#) [1812J2K00222KXT](#)
[1812J2K00472KXT](#) [2-1622820-7-CUT-TAPE](#) [2220J3K00102KXT](#) [2225J2500824KXT](#) [CCR07CG103KM](#) [CGA2B2C0G1H010C](#)
[CGA2B2C0G1H040C](#) [CGA2B2C0G1H050C](#) [CGA2B2C0G1H060D](#) [CGA2B2C0G1H070D](#) [CGA2B2C0G1H151J](#) [CGA2B2C0G1H1R5C](#)
[CGA2B2C0G1H2R2C](#) [CGA2B2C0G1H3R3C](#) [CGA2B2C0G1H680J](#) [CGA2B2C0G1H6R8D](#) [CGA2B2X8R1H221K](#) [CGA2B2X8R1H472K](#)
[CGA3E1X7R1C474K](#)