







## 多層片式陶瓷電容器

## MULTILAYER CHIP CERAMIC CAPACITOR

### ■ 片式陶瓷電容器及相關產品





產品	產品分類	實物圖形	型號規格	電容量範圍	特性介紹	頁碼
TCC系列片容	通用型 COG片容		0402CG	0.1PF~1000PF	在-55℃~125℃工作溫度範圍內,溫度特性為: 0±30ppm/℃(COG)、 0±60ppm/℃(COH)。 應用于各種高頻電路,如:振蕩、計時電路等。	15~18
			0603CG	0.1PF~3,300PF		
			0805CG	0.3PF~22,000PF		
			1206CG	0.3PF~100,000PF		
	通用型 X7R片容		0402B	100PF~0.1μF	在-55℃~125℃工作溫度範圍內,溫度特性為±15%。 應用于隔直、耦合、旁路、鑒頻等電路中。	19~24
			0603B	150PF~0.47μF		
			0805B	150PF~1μF		
			1206B	200PF~2.2μF		
			1210B	220PF~4.7μF		
			1808B	220PF~4.7μF		
			1812B	470PF~4.7μF		
	通用型 X5R片容		0402X	0.1μF~4.7μF	在-55℃~85℃工作溫度範圍內,溫度特性為±15%。 應用于隔直、耦合、旁路、鑒頻等電路中。	25~28
			0603X	0.47μF~10μF		
			0805X	1μF~22μF		
			1206X	2.2μF~100μF		
	通用型 Y5V片容		0402F	1nF~1μF	在-25℃~85℃工作溫度範圍內,溫度特性為+30%, -80%。 應用于隔直、旁路等電路中。	29~32
			0603F	1nF~10μF		
			0805F	1nF~22μF		
			1206F	1nF~47μF		
	通用型 Z5U片容		0402E	1nF~1μF	在10℃~85℃工作溫度範圍內,溫度特性為+22%, -56%。 應用于隔直、旁路等電路中。	33~36
			0603E	1nF~10μF		
			0805E	1nF~22μF		
	通用型 PH片容		0402PH	0.5PF~47PF	在-25℃~85℃工作溫度範圍內,溫度特性為 -150±60PPM/℃。 應用于溫度補償電路中。	37~44
			0603PH	0.5PF~82PF		
			0805PH	0.5PF~120PF		
	通用型 RH片容		0402RH	0.5PF~47PF	在-25℃~85℃工作溫度範圍內,溫度特性為-220±60PPM/℃。 應用于溫度補償電路中。	37~44
			0603RH	0.5PF~82PF		
			0805RH	0.5PF~120PF		







**■ Multilayer Chip Ceramic Capacitor and Correlational Products**

Product	Product Classify	Product Picture	Part Number	Capacitance	Character	Page
TC series MLCC	COG MLCC for generaluse		0402CG	0.1PF ~ 1000PF	Operating temperature range is $-55^{\circ}\text{C} \sim 125^{\circ}\text{C}$ , temperature characteristics is $0 \pm 30\text{PPM}/^{\circ}\text{C}$ (COG), $0 \pm 60\text{PPM}/^{\circ}\text{C}$ (COH). Can be applied to all kinds of high frequency circuits such as oscillator and timing circuits, etc.	15 ~ 18
			0603CG	0.1PF ~ 3,300PF		
			0805CG	0.3PF ~ 22,000PF		
			1206CG	0.3PF ~ 100,000PF		
	X7R MLCC for generaluse		0402B	100PF ~ 0.1 $\mu\text{F}$	Operating temperature range is $-55^{\circ}\text{C} \sim 125^{\circ}\text{C}$ , temperature characteristics is $\pm 15\%$ . Can be applied to DC-blocking, coupling, bypassing frequency discriminating circuits, etc.	19 ~ 24
			0603B	150PF ~ 0.47 $\mu\text{F}$		
			0805B	150PF ~ 1 $\mu\text{F}$		
			1206B	200PF ~ 2.2 $\mu\text{F}$		
			1210B	220PF ~ 4.7 $\mu\text{F}$		
			1808B	220PF ~ 4.7 $\mu\text{F}$		
	X5R MLCC for generaluse		0402X	0.1 $\mu\text{F}$ ~ 4.7 $\mu\text{F}$	Operating temperature range is $-55^{\circ}\text{C} \sim 85^{\circ}\text{C}$ , temperature characteristics is $\pm 15\%$ . Can be applied to DC-blocking, coupling, bypassing frequency discriminating circuits, etc.	25 ~ 28
			0603X	0.47 $\mu\text{F}$ ~ 10 $\mu\text{F}$		
			0805X	1 $\mu\text{F}$ ~ 22 $\mu\text{F}$		
			1206X	2.2 $\mu\text{F}$ ~ 100 $\mu\text{F}$		
	Y5V MLCC for generaluse		0402F	1nF ~ 1 $\mu\text{F}$	Operating temperature range is $-25^{\circ}\text{C} \sim 85^{\circ}\text{C}$ , temperature characteristics is $+30\%$ , $-80\%$ . Can be applied to DC-blocking, bypassing circuits, etc.	29 ~ 32
			0603F	1nF ~ 10 $\mu\text{F}$		
			0805F	1nF ~ 22 $\mu\text{F}$		
			1206F	1nF ~ 47 $\mu\text{F}$		
	Z5U MLCC for generaluse		0402E	1nF ~ 1 $\mu\text{F}$	Operating temperature range is $10^{\circ}\text{C} \sim 85^{\circ}\text{C}$ , temperature characteristics is $+22\%$ , $-56\%$ . Can be applied to DC-blocking, bypassing circuits, etc.	23 ~ 36
			0603E	1nF ~ 10 $\mu\text{F}$		
			0805E	1nF ~ 22 $\mu\text{F}$		
	PH MLCC for generaluse		0402PH	0.5PF ~ 47PF	Operating temperature range is $-25^{\circ}\text{C} \sim 85^{\circ}\text{C}$ , temperature characteristics is $-150 \pm 60\text{PPM}/^{\circ}\text{C}$ . Can be applied to temperature compensating circuits.	37 ~ 44
			0603PH	0.5PF ~ 82PF		
			0805PH	0.5PF ~ 120PF		
	RH MLCC for generaluse		0402RH	0.5PF ~ 47PF	Operating temperature range is $25^{\circ}\text{C} \sim 85^{\circ}\text{C}$ , temperature characteristics is $-220 \pm 60\text{PPM}/^{\circ}\text{C}$ . Can be applied to temperature compensating circuits.	37 ~ 44
			0603RH	0.5PF ~ 82PF		
			0805RH	0.5PF ~ 120PF		

## 多層片式陶瓷電容器

## MULTILAYER CHIP CERAMIC CAPACITOR







產品	產品分類	實物圖形	型號規格	電容量範圍	特性介紹	頁碼
TCC系列片容	通用型 SH片容		0402SH	0.5PF ~ 47PF	在-25℃ ~ 85℃工作溫度範圍 內,溫度特性為: -330 ± 60PPM/℃。 應用于溫度補償電路中。	37~44
			0603SH	0.5PF ~ 82PF		
			0805SH	0.5PF ~ 120PF		
	通用型 TH片容		0402TH	0.5PF ~ 68PF	在-25℃ ~ 85℃工作溫度範圍 內,溫度特性為: -470 ± 60PPM/℃。 應用于溫度補償電路中。	37~44
			0603TH	0.5PF ~ 100PF		
			0805TH	0.5PF ~ 150PF		
	通用型 UJ片容		0402UJ	0.5PF ~ 82PF	在-25℃ ~ 85℃工作溫度範圍 內,溫度特性為: -750 ± 120PPM/℃。 應用于溫度補償電路中。	37~44
			0603UJ	0.5PF ~ 100PF		
			0805UJ	0.5PF ~ 180PF		
	通用型 SL片容		0402SL	0.5PF ~ 470PF	在-25℃ ~ 85℃工作溫度範圍 內,溫度特性為: -1000 ~ 140PPM/℃。 應用于溫度補償電路中。	37~44
			0603SL	0.5PF ~ 1000PF		
			0805SL	0.5PF ~ 2200PF		
高Q型片容	高Q型片容		0402CQ	0.5PF ~ 180PF	自諧振頻率高。 應用于各種高頻電路。	59~62
			0603CQ	0.5PF ~ 680PF		
			0805CQ	0.5PF ~ 1500PF		
	微波片容		0402RF	0.1PF ~ 22PF	自諧振頻率高, 功率大。 應用于無線通訊站, 無線發 射臺電子線路等。	63~66
			0603RF	0.3PF ~ 47PF		
			0805RF	0.3PF ~ 100PF		
			0505RF	0.5PF ~ 100PF		
			1111RF	0.5PF ~ 1000PF		

Product	Product Classify	Product Picture	Part Number	Capacitance	Character	Page
TC series MLCC	SH MLCC for General- use		0402SH	0.5PF~47PF	Operating temperature range is -25°C~85°C, temperature characteristics is -330±60 PPM/°C. Can be applied to temperature compensating circuits.	37~44
			0603SH	0.5PF~82PF		
			0805SH	0.5PF~120PF		
	TH MLCC for General- use		0402TH	0.5PF~68PF	Operating temperature range is -25°C~85°C, temperature characteristics is -470±60PPM/°C. Can be applied to temperature compensating circuits.	37~44
			0603TH	0.5PF~100PF		
			0805TH	0.5PF~150PF		
	UJ MLCC for General- use		0402UJ	0.5PF~82PF	Operating temperature range is -25°C~85°C, temperature characteristics is -750±120 PPM/°C. Can be applied to temperature compensating circuits.	37~44
			0603UJ	0.5PF~100PF		
			0805UJ	0.5PF~180PF		
	SL MLCC for General- use		0402SL	0.5PF~470PF	Operating temperature range is -25°C~85°C, temperature characteristics is -1000±140 PPM/°C. Can be applied to temperature compensating circuits.	37~44
			0603SL	0.5PF~1000PF		
			0805SL	0.5PF~2200PF		
High Q MLCC	High-Q MLCC		0402CQ	0.5PF~180PF	Self-resonance frequency is high. Can be applied to all kinds of high frequency circuits.	59~62
			0603CQ	0.5PF~680PF		
			0805CQ	0.5PF~1500PF		
	Microwave Caps		0402RF	0.1PF~22PF	Self-resonance frequency is high. Can be applied to all kinds of high frequency circuits, power is big. Can be applied to wireless, communication base, wireless launch pad circuits, etc.	63~66
			0603RF	0.3PF~47PF		
			0805RF	0.3PF~100PF		
			0505RF	0.5PF~100PF		
			1111RF	0.5PF~100PF		



## 多層片式陶瓷電容器













## MULTILAYER CHIP CERAMIC CAPACITOR

產品	產品分類	實物圖形	型號規格	電容量範圍	特性介紹	頁碼	
直流中高壓片容	低損耗中高壓片容 (COG類)		100V	0.5PF ~ 27nF	工作電壓高，損耗低。 應用于各種高壓電子 線路。	67~98	
			200V	0.5PF ~ 22nF			
			250V	0.5PF ~ 22nF			
			500V	0.5PF ~ 22nF			
			1000V	0.5PF ~ 4.7nF			
			2000V	0.5PF ~ 1nF			
			3000V	0.5PF ~ 1nF			
			4000V	0.5PF ~ 1nF			
	大容量中高壓片容 (X7R類)		100V	150PF ~ 3.3 μ F	工作電壓高，較引線 圓片高壓電容，生產 的容值範圍寬。 可用于各種高壓電子 線路。		
			200V	150PF ~ 2.2 μ F			
			250V	150PF ~ 2.2 μ F			
			500V	150PF ~ 1 μ F			
			1000V	150PF ~ 56nF			
			2000V	150PF ~ 47nF			
			3000V	150PF ~ 10nF			
			4000V	150PF ~ 8.2nF			
	大容量中高壓片容 (Y5V類)		100V	1nF ~ 2.2 μ F			
			200V	10nF ~ 2.2 μ F			
			250V	10nF ~ 2.2 μ F			
	封裝型中高壓片容(N,B)		4000V	0.5PF ~ 1000PF	采用了封裝形式,工作 電壓得到提高。		99~100
			5000V	0.5PF ~ 1000PF			
大容量片容	大容量X5R片容		0402X	0.1 μ F ~ 10 μ F	電容量較大。 應用于濾波、旁路電 路。	101~104	
			0603X	0.47 μ F ~ 10 μ F			
			0805X	1 μ F ~ 22 μ F			
			1206X	1 μ F ~ 100 μ F			
			1210X	1 μ F ~ 100 μ F			
			1812X	1 μ F ~ 100 μ F			
			大容量Y5V片容				0402F
	0603F	1 μ F ~ 10 μ F					
	0805F	1 μ F ~ 22 μ F					
	1206F	1 μ F ~ 47 μ F					
	1210F	1 μ F ~ 100 μ F					
	1812F	2.2 μ F ~ 100 μ F					

Product	Product Classify	Product Picture	Part Number	Capacitance	Character	Page		
DC Medium-voltage MLCC	Low Dissipation Factor Medium-voltage MLCC (COG)		100V	0.5PF ~ 27nF	Operating voltage is high, dissipation factor is low. Can be applied to all kinds of high-voltage circuits.	67~98		
			200V	0.5PF ~ 22nF				
			250V	0.5PF ~ 22nF				
			500V	0.5PF ~ 22nF				
			1000V	0.5PF ~ 4.7nF				
			2000V	0.5PF ~ 1nF				
			3000V	0.5PF ~ 1nF				
			4000V	0.5PF ~ 1nF				
	High-capacitance Medium-voltage MLCC(X7R)		100V	1nF ~ 3.3 μ F	Operating voltage is high, the capacitance of it is high than that of lead high-voltage disc capacitor. Can be applied to all kinds of high-voltage circuits.			
			200V	1nF ~ 2.2 μ F				
			250V	1nF ~ 2.2 μ F				
			500V	1nF ~ 1 μ F				
			1000V	1nF ~ 56nF				
			2000V	1nF ~ 47nF				
			3000V	680PF ~ 10nF				
			4000V	680PF ~ 8.2nF				
	High-capacitance Medium-voltage MLCC(Y5V)		100V	1nF ~ 2.2 μ F				
			200V	10nF ~ 2.2nF				
			250V	10nF ~ 2.2nF				
	High voltage MLCC(N,B)		4000V	0.5PF ~ 1000PF	Has more than high work voltage.		99~100	
			5000V	0.5PF ~ 1000PF				
	High-capacitance MLCC	X5R High-cap. MLCC		0402X	0.1 μ F ~ 10 μ F		The capacitance is a little bit high. Can be applied to filter, bypassing circuits, etc.	101~104
				0603X	0.47 μ F ~ 10 μ F			
				0805X	1 μ F ~ 22 μ F			
1206X				1 μ F ~ 100 μ F				
1210X				1 μ F ~ 100 μ F				
1812X				1 μ F ~ 100 μ F				
Y5V High-cap. MLCC					0402F	1 μ F		
		0603F	1 μ F ~ 10 μ F					
		0805F	1 μ F ~ 22 μ F					
		1206F	1 μ F ~ 47 μ F					
		1210F	1 μ F ~ 100 μ F					
		1812F	2.2 μ F ~ 100 μ F					









## 多層片式陶瓷電容器

### MULTILAYER CHIP CERAMIC CAPACITOR

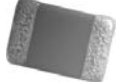







產品	產品分類	實物圖形	型號規格	電容量範圍	特性介紹	頁碼
超小尺寸片容	0201超小容量片容		0201CG	0.5PF ~ 100PF	尺寸小，應用于助聽器，以及IC和LTCC電路等。	105~112
			0201B	100PF ~ 10nF		
			0201F	10nF ~ 100nF		
	超薄尺寸片容		0805CG	0.5PF ~ 330PF	厚度超薄。 主要用于IC底片或IC卡電路。	113~116
			0805B	100PF ~ 22nF		
			1206CG	0.5PF ~ 470PF		
			1206B	100PF ~ 47nF		
排容	0612型四聯體排容		6124N	0.5PF ~ 1000PF	4(或2)只電容片容集于一體。 用于更高密度的表面安裝。用于手機主板，筆記本電腦電路等。	117~122
			6124B	100PF ~ 100nF		
			6124F	470PF ~ 100nF		
	0508型四聯體排容		5084N	0.5PF ~ 100PF		
			5084B	100PF ~ 4.7nF		
			5084F	1nF ~ 22nF		
	0508型二聯體排容		5082N	0.5PF ~ 220PF		
			5082B	100PF ~ 22nF		
			5082F	1nF ~ 47nF		
低ESL片容	0508型低ESL片容		0508N	0.5PF ~ 3300PF	具有低等效串聯電感特性，寄生電感量小。主要用于高頻電路。	123~126
			0508B	100PF ~ 100nF		
			0508F	1nF ~ 470nF		
	0612型低ESL片容		0612N	0.5PF ~ 3300PF		
			0612B	1nF ~ 220nF		
			0612F	10nF ~ 2.2 μ F		
三端EML濾波器	0805型三端濾波器		5081N	10PF ~ 1200PF	具有優良的通流特性，適合表面安裝。具有良好的濾波特性，良好的吸收噪音，抑制浪涌脈衝的作用。 主要應用于移動電路及基站通訊設備等。	127~132
			5081B	1000PF ~ 330nF		
	1205型三端濾波器		5121N	10PF ~ 1500PF		
			5121B	1000PF ~ 330nF		
	1806型三端濾波器		6181N	10PF ~ 1500PF		
			6181B	1000PF ~ 330nF		
安規片容	COG安規片容		1808CG	2PF ~ 100PF	符合安規認證。	133~136
			1812CG	2PF ~ 150PF		
	X7R安規片容		2220CG	2PF ~ 330PF	主要用于信息設備的濾波器。	
			2225CG	2PF ~ 330PF		
			1808B	100PF ~ 3.3nF		
			1812B	100PF ~ 4.7nF		
			2220B	100PF ~ 4.7nF		
			2225B	100PF ~ 4.7nF		

Product	Product Classify	Product Picture	Part Number	Capacitance	Character	Page
Ultra-small MLCC	0201 MLCC		0201CG	0.5PF ~ 100PF	The size is small. Can be applied to heating aids, IC and LTCC circuits.	105~112
			0201B	100PF ~ 10nF		
			0201F	10nF ~ 100nF		
	Ultra-thin MLCC		0805CG	0.5PF ~ 330PF	Ultra-thin. Mainly be applied to iC base or IC card circuits.	113~116
			0805B	100PF ~ 22nF		
			1206CG	0.5PF ~ 470PF		
			1206B	100PF ~ 47nF		
	C-Array	0612 four-elements C-Arrays		6124N	0.5PF ~ 1000PF	Four(or two)pieces MLCC fixed together. Can be applied to higher density surface ammounting such as the mainbord of the mobile phone, notebook computer circuits, etc.
6124B				100PF ~ 100nF		
6124F				470PF ~ 100nF		
0508 four-elements C-Arrays			5084N	0.5PF ~ 100PF		
			5084B	100PF ~ 4.7nF		
			5084F	1nF ~ 22nF		
0508 two-elements C-Arrays			5082N	0.5PF ~ 220PF		
			5082B	100PF ~ 22nF		
			5082F	1nF ~ 47nF		
Low ESL MLCC	0508 type low Esl MLCC		0508N	0.5PF ~ 3300PF	Have the properties of low ESL, autoecious inductance is small. Mainly be applied to high frequency circuits.	123~126
			0508B	100PF ~ 100nF		
			0508F	1nF ~ 470nF		
	0612 type low Esl MLCC		0612N	0.5PF ~ 3300PF		
			0612B	1nF ~ 220nF		
			0612F	10nF ~ 2.2 μ F		
Three Terminal EMI filter	0805 type		5081N	10PF ~ 1200PF	Has beautiful current circulating character, good filtering character and impulse restraining, mainly be use to base communication equipment.	127~132
			5081B	1000PF ~ 330nF		
	1205 type		5121N	10PF ~ 1500PF		
			5121B	1000PF ~ 330nF		
	1806 type		6181N	10PF ~ 1500PF		
			6181B	1000PF ~ 330nF		
Type MLCC	COG type MLCC		1808CG	2PF ~ 100PF	Conform to safety certificate	133~136
			1812CG	2PF ~ 150PF		
			2220CG	2PF ~ 330PF		
			2225CG	2PF ~ 330PF		
	X7R type MLCC		1808B	100PF ~ 3.3nF	Mainly be use to filters for information equipment.	
			1812B	100PF ~ 4.7nF		
			2220B	100PF ~ 4.7nF		
			2225B	100pF ~ 4.7nF		

■ 片式陶瓷電容器及相關產品







產品	產品分類	實物圖形	型號規格	可靠性	包裝
LCO系列片容	通用型COG片容		0402CG	第45~50頁	第139~161頁
			0603CG		
			0805CG		
			1206CG		
	通用型X7R片容		0402B	第51~58頁	
			0603B		
			0805B		
			1206B		
	通用型Y5V片容		0402F	第51~58頁	
			0603F		
			0805F		
			1206F		
	通用型Z5U片容		0402E	第51~58頁	
			0603E		
			0805E		
	通用型PH片容		0402PH	第45~50頁	
			0603PH		
			0805PH		
	通用型RH片容		0402RH	第45~50頁	
			0603RH		
			0805RH		
	通用型SH片容		0402SH	第45~50頁	
			0603SH		
			0805SH		
	通用型TH片容		0402TH	第45~50頁	
			0603TH		
			0805TH		







■ Multilayer Chip Ceramic Capacitor and Correlational Products

Product	Product Classifv	Product Picture	Part Number	Reliability	Packaging
TC series MLCC	COG MLCC for general -use		0402CG	Page 45~50	Page 139~161
			0603CG		
			0805CG		
			1206CG		
	X7R MLCC for general -use		0402B	Page 51~58	
			0603B		
			0805B		
			1206B		
	Y5V MLCC for general -use		0402F	Page 51~58	
			0603F		
			0805F		
			1206F		
	Z5U MLCC for general -use		0402E	Page 51~58	
			0603E		
			0805E		
	PH MLCC for general -use		0402PH	Page 45~50	
			0603PH		
			0805PH		
	RH MLCC for general -use		0402RH	Page 45~50	
			0603RH		
			0805RH		
	SH MLCC for general -use		0402SH	Page 45~50	
			0603SH		
			0805SH		
TH MLCC for general -use		0402TH	Page 45~50		
		0603TH			
		0805TH			

# 多層片式陶瓷電容器

## MULTILAYER CHIP CERAMIC CAPACITOR

產品	產品分類	實物圖形	型號規格	可靠性	包裝
1C系列片容	通用型UJ片容		0402UJ	第45~50頁	第139~161頁
			0603UJ		
			0805UJ		
	通用型SL片容		0402SL	第45~50頁	
			0603SL		
			0805SL		
直流中高壓片容	低損耗中高壓片容 (COG類)		100V	第81~86頁	
			200V		
			250V		
			500V		
			1000V		
			2000V		
			3000V		
			4000V		
	大容量中高壓片容 (X7R類)		100V	第87~92頁	
			200V		
			250V		
			500V		
			1000V		
			2000V		
			3000V		
			4000V		
	大容量中高壓片容 (Y5V類)		100V	第93~98頁	
			200V		
			250V		
	封裝型中高壓片容 (N,B)		4000V	第99~100頁	
			5000V		

Product	Product Classify	Product Picture	Part Number	Reliability	Packaging
TC series MLCC	UJ MLCC for general -use		0402UJ	Pages 45~50	
			0603UJ		
			0805UJ		
	SL MLCC for general -use		0402SL	Pages 45~50	
			0603SL		
			0805SL		
DC Medium-voltage MLCC	Low Dissipation Factor Medium-voltage MLCC(COG)		100V	Pages 81~86	
			200V		
			250V		
			500V		
			1000V		
			2000V		
			3000V		
			4000V		
	High-capacitance Medium-voltage MLCC(X7R)		100V	Pages 87~92	
			200V		
			250V		
			500V		
			1000V		
			2000V		
			3000V		
			4000V		
	High-capacitance Medium-voltage MLCC(Y5V)		100V	Pages 93~98	
			200V		
			250V		
	High voltage(N,B)		4000V	Pages 99~100	
			5000V		



### ■ 片式電容器結構圖

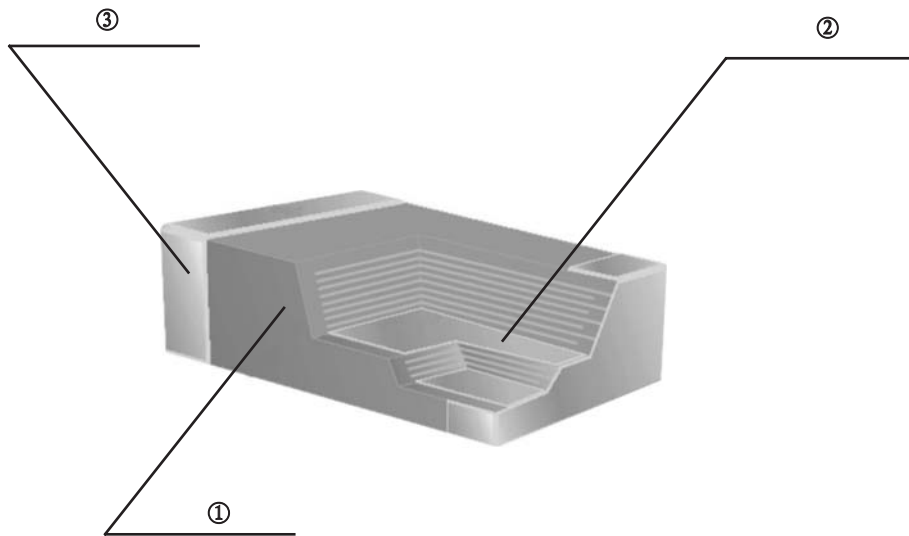

序號	①	②	③	用途
名稱	陶瓷體	內電極	外電極	
成份	匹配貴金屬共燒 的陶瓷介質	銀鈮合金	銀-鎳-錫	表面貼裝
		銀鈮合金	銀	加工引綫
	匹配賤金屬共燒 的陶瓷介質	鎳	銅-鎳-錫	表面貼裝
		鎳	銅	加工引綫

■ MLCC Structure

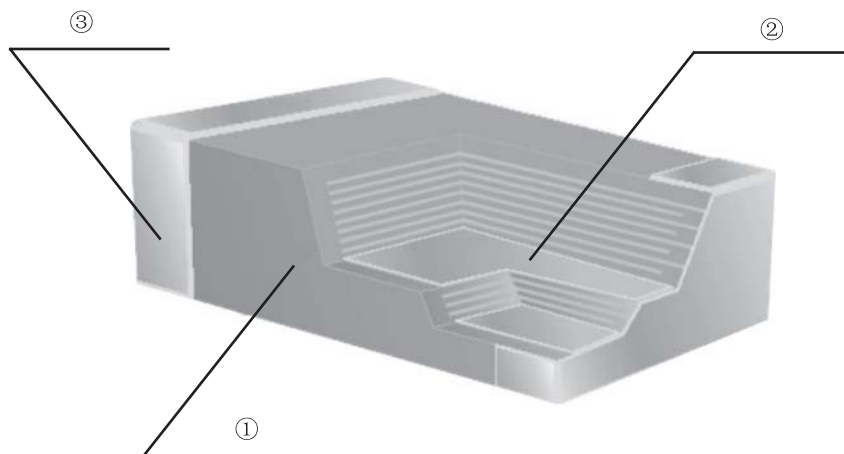

NO.	①	②	③	Use
Name	Ceramic body	Inner electrode	Outer electrode	
Content	ceramic dielectric based on expensive metal	Pd/Ag	Ag-Ni-Sn	SMD
		Pd/Ag	Ag	Used for Leads MLCC
	ceramic dielectric based on cheap metal	Ni	Cu-Ni-Sn	SMD
		Ni	Cu	Used for Leads MLCC

# 多層片式陶瓷電容器

## MULTILAYER CHIP CERAMIC CAPACITOR

### ■ 通用型COG/COH片容

通用型COG片容屬於 I 類高頻電容器，其電容量非常穩定，幾乎不隨溫度、電壓和時間的變化而變化。尤其適用於高頻電子線路。

#### ● 特性

- \* 具有高的電容量穩定性,在-55℃ ~ 125℃ 工作範圍內,其溫度系數為 $0 \pm 30\text{ppm}/^\circ\text{C}$ 、 $0 \pm 60\text{ppm}/^\circ\text{C}$ 。
- \* 疊層獨石結構,具有高可靠性。
- \* 優良的焊接性和耐焊性,適用於回流焊和波峰焊。

#### ● 應用

- \* 適用於各種高頻電子線路。

#### ● 產品規格型號表示方法

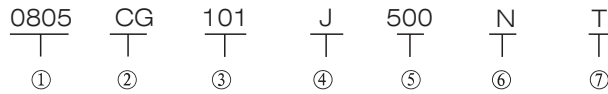

① 尺寸		
型號	英制(英寸)	公制(毫米)
0402	0.04 × 0.02	1.00 × 0.50
0603	0.06 × 0.03	1.60 × 0.80
0805	0.08 × 0.05	2.00 × 1.25
1206	0.12 × 0.06	3.20 × 1.60

② 介質種類	
代碼	介質材料
CG	COG或NPO
CH	COH

③ 標稱電容量(PF)	
表示方式	實際值
100	$10 \times 10^0$
101	$10 \times 10^1$
102	$10 \times 10^2$

④ 誤差級別	
代碼	誤差
J	± 5.00%
G	± 2.00%
C	± 0.25PF
B	± 0.10PF
D	± 0.50PF

⑤ 工作電壓	
表示方法	實際電壓
6R3	6.3V
100	10V
250	25V
500	50V

⑥ 端頭類別	
表示方法	端頭材料
S	純銀端頭
C	純銅端頭
N	三層電鍍端頭 (銀或銅層/鎳層/錫層)

⑦ 包裝方式	
表示方法	包裝
無標記	袋裝散包裝
T	編帶包裝
B	塑料盒散包裝

#### ● 外形尺寸

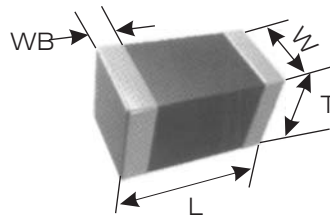

規格型號		尺寸( mm)			
英制表示	公制表示	L	W	T	WB
0402	1005	$1.00 \pm 0.05$	$0.50 \pm 0.05$	$0.50 \pm 0.05$	$0.25 \pm 0.10$
0603	1608	$1.60 \pm 0.10$	$0.80 \pm 0.10$	$0.80 \pm 0.10$	$0.30 \pm 0.10$
0805	2012	$2.00 \pm 0.20$	$1.25 \pm 0.20$	$0.80 \pm 0.20$ $1.00 \pm 0.20$ $1.25 \pm 0.20$	$0.50 \pm 0.20$
1206	3216	$3.20 \pm 0.30$	$1.60 \pm 0.30$	$0.80 \pm 0.20$ $1.00 \pm 0.20$ $1.25 \pm 0.20$ $1.60 \pm 0.20$	$0.60 \pm 0.30$

## COG/COH MLCC for general-use

COG MLCC for General-use is class I high frequency capacitor, its capacitance is very stable, almost will not change along with the temperature, voltage and time. Specially be suitable for high frequency circuits.

### Features

- \* The capacitance is very stable, its operating temperature is  $-55^{\circ}\text{C}\sim 125^{\circ}\text{C}$ , within the range, the temperature coefficient is  $0\pm 30\text{ppm}/^{\circ}\text{C}$ ,  $0\pm 60\text{ppm}/^{\circ}\text{C}$ .
- \* It has multi-layer monolithic structure, has high reliability.
- \* It has good solderability and soldering resistance, suitable for flow/reflow soldering.

### Application

- \* It is suitable for all kinds of high frequency circuits.

### Product Part Number Expression

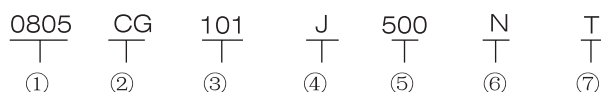

①Dimensions		
Type	British (Inch)	Metric (mm)
0402	$0.04\times 0.02$	$1.00\times 0.50$
0603	$0.06\times 0.03$	$1.60\times 0.80$
0805	$0.08\times 0.05$	$2.00\times 1.25$
1206	$0.12\times 0.06$	$3.20\times 1.60$

②Dielectric Type	
Code	Dielectric
CG	COG or NPO
CH	COH

③Normal Capacitance(PF)	
Expression Method	Actual Value
100	$10\times 10^0$
101	$10\times 10^1$
102	$10\times 10^2$

④Capacitance Tolerance	
Code	Tolerance
J	$\pm 5.00\%$
G	$\pm 2.00\%$
C	$\pm 0.25\text{PF}$
B	$\pm 0.10\text{PF}$
D	$\pm 0.50\text{PF}$

⑤Rated Voltage	
Expression Method	Actual Value
500	50V
250	25V
101	100V
201	200V

⑥Termination Type	
Expression Method	Termination Material
S	Pure Silver
C	Pure Copper
N	Three Layers Plating Terminal (Silver or Copper layer/ Nickel layer /Tin layer)

⑦Package Method	
Expression Method	Packaging
No Mark	Bulk Packaging in a Bag
T	Taping Packaging
B	Bulk Plastic Box Packaging

### Outside Dimension

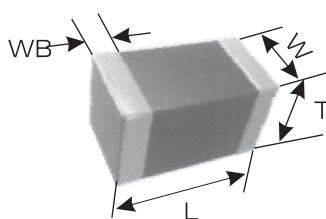

Type		Dimension (mm)			
British Expression	Metric Expression	L	W	T	WB
0402	1005	$1.00\pm 0.05$	$0.50\pm 0.05$	$0.50\pm 0.05$	$0.25\pm 0.10$
0603	1608	$1.60\pm 0.10$	$0.80\pm 0.10$	$0.80\pm 0.10$	$0.30\pm 0.10$
0805	2012	$2.00\pm 0.20$	$1.25\pm 0.20$	$0.80\pm 0.20$ $1.00\pm 0.20$ $1.25\pm 0.20$	$0.50\pm 0.20$
1206	3216	$3.20\pm 0.30$	$1.60\pm 0.30$	$0.80\pm 0.20$ $1.00\pm 0.20$ $1.25\pm 0.20$ $1.60\pm 0.20$	$0.60\pm 0.30$

# 多層片式陶瓷電容器

## MULTILAYER CHIP CERAMIC CAPACITOR

- 電容量範圍

項目	通用型COG/COH片容																			
尺寸	0402					0603					0805					1206				
工作電壓	6.3V	10V	16V	25V	50V	6.3V	10V	16V	25V	50V	6.3V	10V	16V	25V	50V	6.3V	10V	16V	25V	50V
電容量																				
0.1PF																				
0.3PF																				
0.5PF																				
1PF																				
2PF																				
5PF																				
6PF																				
7PF																				
10PF																				
22PF																				
33PF																				
47PF																				
68PF																				
100PF																				
120PF																				
150PF																				
180PF																				
220PF																				
330PF																				
470PF																				
560PF																				
680PF																				
1000PF																				
2200PF																				
2700PF																				
3300PF																				
4700PF																				
5600PF																				
6800PF																				
10nF																				
12nF																				
15nF																				
22nF																				
47nF																				
68nF																				
100nF																				

**Capacitance Range**

Item	COG/COH MLCC for general-use																			
	0402					0603					0805					1206				
Rated Voltage	6.3V	10V	16V	25V	50V	6.3V	10V	16V	25V	50V	6.3V	10V	16V	25V	50V	6.3V	10V	16V	25V	50V
Capacitance																				
0.5PF																				
1PF																				
2PF																				
3PF																				
4PF																				
5PF																				
6PF																				
7PF																				
10PF																				
22PF																				
33PF																				
47PF																				
68PF																				
100PF																				
120PF																				
150PF																				
180PF																				
220PF																				
330PF																				
470PF																				
560PF																				
680PF																				
1000PF																				
2200PF																				
2700PF																				
3300PF																				
4700PF																				
5600PF																				
6800PF																				
10nF																				
12nF																				
15nF																				
22nF																				
47nF																				
68nF																				
100nF																				

# 多層片式陶瓷電容器

## MULTILAYER CHIP CERAMIC CAPACITOR

### ■ 通用型X7R片容

通用型X7R片容屬於Ⅱ類低頻電容器，其電容量相對穩定。

#### ● 特性

- \* 具有較高的電容量且較穩定，在-55℃ ~ 125℃工作範圍內，其溫度特性為±15%。
- \* 疊層獨石結構，具有高可靠性。
- \* 優良的焊接性和耐焊性，適用於回流焊和波峰焊。

#### ● 應用

- \* 適用於各種濾波，耦合電路。

#### ● 產品規格型號表示方法

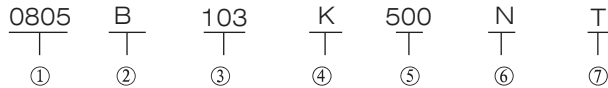

① 尺寸		
型號	英制(英寸)	公制(毫米)
0402	0.04 × 0.02	1.00 × 0.50
0603	0.06 × 0.03	1.60 × 0.80
0805	0.08 × 0.05	2.00 × 1.25
1206	0.12 × 0.06	3.20 × 1.60
1210	0.12 × 0.10	3.20 × 2.50
1812	0.18 × 0.12	4.50 × 3.20
2220	0.22 × 0.20	5.70 × 5.00

② 介質種類	
代碼	介質材料
B	X7R

③ 標稱電容量(PF)	
表示方式	實際值
101	10 × 10 <sup>1</sup>
102	10 × 10 <sup>2</sup>
103	10 × 10 <sup>3</sup>

④ 誤差級別	
代碼	誤差
J	±5%
K	±10%
M	±20%

⑦ 包裝方式	
表示方法	包裝
無標記	袋裝散包裝
T	編帶包裝
B	塑料盒散包裝

⑤ 工作電壓	
表示方法	實際電壓
6R3	6.3V
100	10V
250	25V
500	50V

⑥ 端頭類別	
表示方法	端頭材料
S	純銀端頭
C	純銅端頭
N	三層電鍍端頭 (銀或銅層/鎳層/錫層)

#### ● 外形尺寸

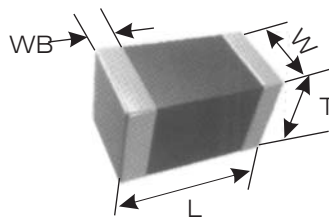

規格型號		尺寸( mm)			
英制表示	公制表示	L	W	T	WB
0402	1005	1.00 ± 0.05	0.50 ± 0.05	0.50 ± 0.05	0.25 ± 0.10
0603	1608	1.60 ± 0.10	0.80 ± 0.10	0.80 ± 0.10	0.30 ± 0.10
0805	2012	2.00 ± 0.20	1.25 ± 0.20	0.80 ± 0.20 1.00 ± 0.20 1.25 ± 0.20	0.50 ± 0.20
1206	3216	3.20 ± 0.30	1.60 ± 0.20	0.80 ± 0.20 1.00 ± 0.20 1.25 ± 0.20	0.60 ± 0.30
1210	3225	3.20 ± 0.30	2.50 ± 0.30	≤ 2.80	0.60 ± 0.30
1812	4532	4.50 ± 0.40	3.20 ± 0.30	≤ 3.50	0.60 ± 0.30
2220	5750	5.70 ± 0.40	5.00 ± 0.40	≤ 3.50	0.60 ± 0.30

## ■ X7R MLCC for General-use

X7R MLCC for General-use is class II low frequency capacitor, its capacitance is stable.

### • Properties

- \* The capacitance is stable, its operating temperature is  $-55^{\circ}\text{C} \sim 125^{\circ}\text{C}$ , within the range, the temperature coefficient is  $\pm 15\%$ .
- \* It has multi-layer monolithic structure, has high reliability.
- \* It has good solderability and soldering resistance, suitable for flow soldering/reflow soldering.

### • Applications

It is suitable for all kinds of filter and coupling circuits.

### • Product part number expression method

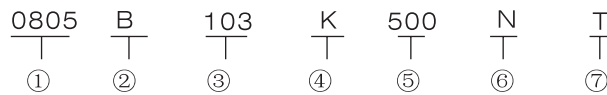

①Dimensions		
Type	British (Inch)	Metric (mm)
0402	0.04 × 0.02	1.00 × 0.50
0603	0.06 × 0.03	1.60 × 0.80
0805	0.08 × 0.05	2.00 × 1.25
1206	0.12 × 0.06	3.20 × 1.60
1210	0.12 × 0.10	3.20 × 2.50
1812	0.18 × 0.12	4.50 × 3.20
2220	0.22 × 0.20	5.70 × 5.00

③Normal Capacitance (PF)	
Expression Method	Actual Value
101	$10 \times 10^1$
102	$10 \times 10^2$
103	$10 \times 10^3$

⑥Termination Type	
Expression Method	Termination Material
S	Pure Silver
C	Pure Copper
N	Three Layers Plating Terminal (Silver or Copper layer/ Nickel layer/ Tin layer)

④Capacitance Tolerance	
Code	Tolerance
J	$\pm 5\%$
K	$\pm 10\%$
M	$\pm 20\%$

②Dielectric Type	
Code	Dielectric Material
B	X7R

⑤Rated Voltage	
Expression Method	Actual Value
6R3	6.3V
100	10V
250	25V
500	50V

⑦Package Method	
Expression Method	Packaging
No Mark	Bulk Packaging in a Bag
T	Taping Packaging
B	Bulk Plastic Box Packaging

### • Outside Dimension

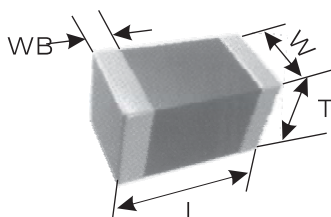

Type		Dimension (mm)			
British expression	Metric expression	L	W	T	WB
0402	1005	$1.00 \pm 0.05$	$0.50 \pm 0.05$	$0.50 \pm 0.05$	$0.25 \pm 0.10$
0603	1608	$1.60 \pm 0.10$	$0.80 \pm 0.10$	$0.80 \pm 0.10$	$0.30 \pm 0.10$
0805	2012	$2.00 \pm 0.20$	$1.25 \pm 0.20$	$0.80 \pm 0.20$ $1.00 \pm 0.20$ $1.25 \pm 0.20$	$0.50 \pm 0.20$
1206	3216	$3.20 \pm 0.30$	$1.60 \pm 0.20$	$0.80 \pm 0.20$ $1.00 \pm 0.20$ $1.25 \pm 0.20$	$0.60 \pm 0.30$
1210	3225	$3.20 \pm 0.30$	$2.50 \pm 0.30$	$\leq 2.80$	$0.60 \pm 0.30$
1812	4532	$4.50 \pm 0.40$	$3.20 \pm 0.30$	$\leq 3.50$	$0.60 \pm 0.30$
2220	5750	$5.70 \pm 0.40$	$5.00 \pm 0.40$	$\leq 3.50$	$0.60 \pm 0.30$



# 多層片式陶瓷電容器

## MULTILAYER CHIP CERAMIC CAPACITOR

- 電容量範圍

項目	通用型X7R片容																		
	0402					0603					0805					1206			
尺寸																			
工作電壓	6.3V	10V	16V	25V	50V	6.3V	10V	16V	25V	50V	6.3V	10V	16V	25V	50V	4V	16V	25V	50V
電容量																			
100PF																			
150PF																			
200PF																			
470PF																			
1000PF																			
1.5nF																			
2.2nF																			
3.3nF																			
4.7nF																			
6.8nF																			
10nF																			
12nF																			
15nF																			
22nF																			
27nF																			
33nF																			
39nF																			
47nF																			
56nF																			
68nF																			
100nF																			
150nF																			
220nF																			
270nF																			
330nF																			
470nF																			
820nF																			
1 μF																			
2.2 μF																			
4.7 μF																			
10 μF																			
22 μF																			
27 μF																			
33 μF																			
47 μF																			



# 多層片式陶瓷電容器

## MULTILAYER CHIP CERAMIC CAPACITOR

- 電容量範圍

項目	通用型X7R片容														
	1210					1808					1812				
尺寸															
工作電壓	6.3V	10V	16V	25V	50V	6.3V	10V	16V	25V	50V	6.3V	10V	16V	25V	50V
電容量															
220PF															
330PF															
470PF															
680PF															
1000PF															
1.5nF															
2.2nF															
3.3nF															
4.7nF															
6.8nF															
10nF															
12nF															
15nF															
22nF															
27nF															
33nF															
39nF															
47nF															
56nF															
68nF															
100nF															
150nF															
220nF															
270nF															
330nF															
470nF															
820nF															
1 μ F															
2.2 μ F															
4.7 μ F															
6.8 μ F															
10 μ F															
22 μ F															
33 μ F															
47 μ F															

- Capacitance Range

Item	X7R MLCC for general-use														
Dimension	1210					1808					1812				
Rated Voltage	6.3V	10V	16V	25V	50V	6.3V	10V	16V	25V	50V	6.3V	10V	16V	25V	50V
Capacitance															
220PF															
330PF															
470PF															
680PF															
1000PF															
1.5nF															
2.2nF															
3.3nF															
4.7nF															
6.8nF															
10nF															
12nF															
15nF															
22nF															
27nF															
33nF															
39nF															
47nF															
56nF															
68nF															
100nF															
150nF															
220nF															
270nF															
330nF															
470nF															
820nF															
1 μ F															
2.2 μ F															
4.7 μ F															
6.8 μ F															
10 μ F															
22 μ F															
33 μ F															
47 μ F															

# 多層片式陶瓷電容器

## MULTILAYER CHIP CERAMIC CAPACITOR

### ■ 通用型X5R片容

通用型X5R片容屬於Ⅱ類低頻電容器，其電容量相對穩定。

#### ● 特性

- \* 電容量較大，比容大。
- \* 具有較高的電容量且較穩定，在-55℃ ~ +85℃工作範圍內，其溫度特性為 $\leq \pm 15\%$ 。
- \* 疊層獨石結構，具有高可靠性。
- \* 優良的焊接性和耐焊性，適用於回流焊和波峰焊。

#### ● 應用

- \* 適用於各種濾波，耦合電路。

#### ● 產品規格型號表示方法

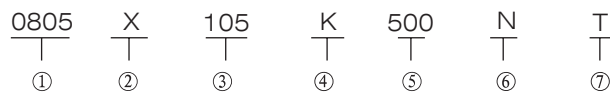

① 尺寸		
型號	英制(英寸)	公制(毫米)
0402	0.04 × 0.02	1.00 × 0.50
0603	0.06 × 0.03	1.60 × 0.80
0805	0.08 × 0.05	2.00 × 1.25
1206	0.12 × 0.06	3.20 × 1.60

② 介質種類	
代碼	介質材料
X	X5R

③ 標稱電容量(PF)	
表示方式	實際值
104	$10 \times 10^4$
105	$10 \times 10^5$
106	$10 \times 10^6$

④ 誤差級別	
代碼	誤差
J	$\pm 5\%$
K	$\pm 10\%$

⑤ 工作電壓	
表示方法	實際電壓
6R3	6.3V
100	10V
250	25V

⑥ 端頭類別	
表示方法	端頭材料
S	純銀端頭
C	純銅端頭
N	三層電鍍端頭 (銀或銅層/鎳層/錫層)

⑦ 包裝方式	
表示方法	包裝
無標記	袋裝散包裝
T	編帶包裝
B	塑料盒散包裝

#### ● 外形尺寸

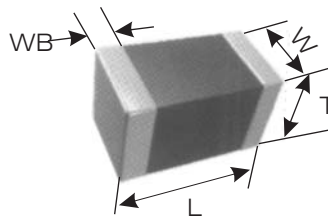

規格型號		尺寸( mm)			
英制表示	公制表示	L	W	T	WB
0402	1005	$1.00 \pm 0.05$	$0.50 \pm 0.05$	$0.50 \pm 0.05$	$0.25 \pm 0.10$
0603	1608	$1.60 \pm 0.10$	$0.80 \pm 0.10$	$0.80 \pm 0.10$	$0.30 \pm 0.10$
0805	2012	$2.00 \pm 0.20$	$1.25 \pm 0.20$	$0.80 \pm 0.20$ $1.00 \pm 0.20$ $1.25 \pm 0.20$	$0.50 \pm 0.20$
1206	3216	$3.20 \pm 0.30$	$1.60 \pm 0.30$	$0.80 \pm 0.20$ $1.00 \pm 0.20$ $1.25 \pm 0.20$	$0.60 \pm 0.30$

## ■ X5R Multilayer Chip Ceramic Capacitor

X5R MLCC for General-use is class II low frequency capacitor, its capacitance is stable.

### • Features

- \* Capacitance is big, unit capacitance is big.
- \* The Capacitance is stable, its operating temperature is  $-55^{\circ}\text{C}$  and  $+85^{\circ}\text{C}$ , within the range, the temperature coefficient is  $\pm 15\%$ .
- \* It has multi-layer monolithic structure, has high reliability.
- \* It has good solderability and soldering resistance, suitable for flow soldering/reflow soldering.

### • Application

- \* It is suitable for all kinds of filter and coupling circuits.

### • Product Part Number Expression

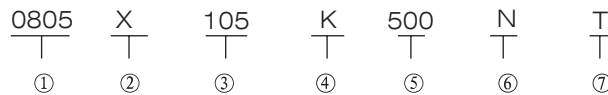

①Dimensions		
Type	British (Inch)	Metric (mm)
0402	0.04 × 0.02	1.00 × 0.50
0603	0.06 × 0.03	1.60 × 0.80
0805	0.08 × 0.05	2.00 × 1.25
1206	0.12 × 0.06	3.20 × 1.60

②Dielectric Type	
Code	Dielectric Material
X	X5R

③Normal Capacitance(PF)	
Expression Method	Actual Value
104	$10 \times 10^4$
105	$10 \times 10^5$
106	$10 \times 10^6$

④Capacitance Tolerance	
Code	Tolerance
J	$\pm 5\%$
K	$\pm 10\%$

⑤Rated Voltage	
Expression Method	Actual Value
6R3	6.3V
100	10V
250	25V

⑥Termination Type	
Expression Method	Termination Material
S	Pure Silver
C	Pure Copper
N	Three Layers Plating Terminal (Silver or Copper layer/Nickel layer /Tin layer)

⑦Package Method	
Expression Method	Packaging
No Mark	Bulk Packaging in a Bag
T	Taping Packaging
B	Bulk Plastic Box Packaging

### • Outside Dimension

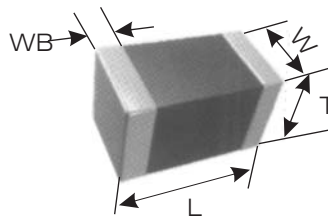

Type		Dimension (mm)			
British expression	Metric expression	L	W	T	WB
0402	1005	$1.00 \pm 0.05$	$0.50 \pm 0.05$	$0.50 \pm 0.05$	$0.25 \pm 0.10$
0603	1608	$1.60 \pm 0.10$	$0.80 \pm 0.10$	$0.80 \pm 0.10$	$0.30 \pm 0.10$
0805	2012	$2.00 \pm 0.20$	$1.25 \pm 0.20$	$0.80 \pm 0.20$ $1.00 \pm 0.20$ $1.25 \pm 0.20$	$0.50 \pm 0.20$
1206	3216	$3.20 \pm 0.30$	$1.60 \pm 0.30$	$0.80 \pm 0.20$ $1.00 \pm 0.20$ $1.25 \pm 0.20$	$0.60 \pm 0.30$

# 多層片式陶瓷電容器

## MULTILAYER CHIP CERAMIC CAPACITOR

- 電容量範圍

項目	通用型X5R片容															
	0402				0603				0805				1206			
尺寸																
工作電壓	6.3V	10V	16V	25V	6.3V	10V	16V	25V	6.3V	10V	16V	25V	6.3V	10V	16V	25V
電容量																
100nF	■	■	■	■												
220nF																
330nF																
470nF					■	■	■	■								
680nF					■	■	■	■								
1 μF	■	■	■	■					■	■	■	■				
2.2 μF		■	■	■						■	■	■	■	■	■	■
3.3 μF													■	■	■	■
4.7 μF	■												■	■	■	■
6.8 μF																
10 μF					■	■	■	■								
22 μF									■	■	■	■				
33 μF																
47 μF																
100uF													■	■	■	■

- Capacitance Range

Item	X5R MLCC for general-use															
Dimension	0402				0603				0805				1206			
Rated Voltage	6.3V	10V	16V	25V	6.3V	10V	16V	25V	6.3V	10V	16V	25V	6.3V	10V	16V	25V
Capacitance																
100nF	■	■	■	■												
220nF																
330nF																
470nF					■	■	■	■								
680nF																
1 μF			■						■	■	■	■				
2.2 μF		■								■	■	■	■	■	■	■
3.3 μF																
4.7 μF	■															
6.8 μF					■	■										
10 μF					■	■			■	■	■	■				
22 μF									■	■						
33 μF																
47 μF																
100uF													■			



### ■ 通用型Y5V片容

通用型Y5V片容屬於Ⅱ類低頻電容器，其電容量受溫度、電壓、時間變化大。

#### ● 特性

- \* 在-25℃ ~ 85℃工作範圍內，其溫度特性為+30%，-80%。
- \* 疊層獨石結構，具有高可靠性。
- \* 優良的可焊性和耐焊性，適用於回流焊和波峰焊。

#### ● 應用

適用於各種濾波線路。

#### ● 產品規格型號表示方法



① 尺寸		
型號	英制(英寸)	公制(毫米)
0402	0.04 × 0.02	1.00 × 0.50
0603	0.06 × 0.03	1.60 × 0.80
0805	0.08 × 0.05	2.00 × 1.25
1206	0.12 × 0.06	3.20 × 1.60

② 介質種類	
代碼	介質材料
F	Y5V

③ 標稱電容量(PF)	
表示方式	實際值
102	10 × 10 <sup>2</sup>
103	10 × 10 <sup>3</sup>
104	10 × 10 <sup>4</sup>

④ 誤差級別	
代碼	誤差
M	± 20%
Z	+80% -20%

⑤ 工作電壓	
表示方法	實際電壓
6R3	6.3V
100	10V
250	25V
500	50V

⑥ 端頭類別	
表示方法	端頭材料
S	純銀端頭
C	純銅端頭
N	三層電鍍端頭 (銀或銅層/鎳層/錫層)

⑦ 包裝方式	
表示方法	包裝
無標記	袋裝散包裝
T	編帶包裝
B	塑料盒散包裝

#### ● 外形尺寸

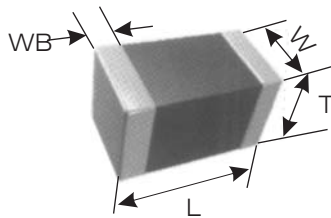

規格型號		尺寸( mm)			
英制表示	公制表示	L	W	T	WB
0402	1005	1.00 ± 0.05	0.50 ± 0.05	0.50 ± 0.05	0.25 ± 0.10
0603	1608	1.60 ± 0.10	0.80 ± 0.10	0.80 ± 0.10	0.30 ± 0.10
0805	2012	2.00 ± 0.20	1.25 ± 0.20	0.80 ± 0.20 1.00 ± 0.20 1.25 ± 0.20	0.50 ± 0.20
1206	3216	3.20 ± 0.30	1.60 ± 0.30	0.80 ± 0.20 1.00 ± 0.20 1.25 ± 0.20	0.60 ± 0.30

## ■ Y5V MLCC for General-use

Y5V MLCC for General-use is class II low frequency capacitor, its capacitance will change a lot along with the temperature, voltage, time.

### • Features

- \* Its operating temperature is  $-25^{\circ}\text{C} \sim 85^{\circ}\text{C}$ , within the range, the temperature coefficient is  $+30\%$ ,  $-80\%$ .
- \* It has multi-layer monolithic structure, has high reliability.
- \* It has good solderability and soldering resistance, suitable for flow soldering/reflow soldering.

### • Applications

It is suitable for all kinds of filter circuits.

### • Product Part Number Expression

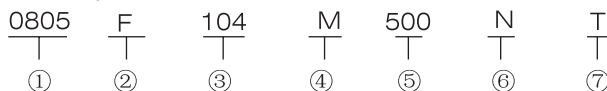

①Dimensions		
Type	British (Inch)	Metric (mm)
0402	$0.04 \times 0.02$	$1.00 \times 0.50$
0603	$0.06 \times 0.03$	$1.60 \times 0.80$
0805	$0.08 \times 0.05$	$2.00 \times 1.25$
1206	$0.12 \times 0.06$	$3.20 \times 1.60$

②Dielectric Type	
Code	Dielectric
F	Y5V

③Normal Capacitance(PF)	
Expression Method	Actual Value
102	$10 \times 10^2$
103	$10 \times 10^3$
104	$10 \times 10^4$

④Capacitance Tolerance	
Code	Tolerance
M	$\pm 20\%$
Z	$+80\%$ $-20\%$

⑤Rated Voltage	
Expression Method	Actual Value
250	25V
500	50V
101	100V
201	200V

⑥Termination Type	
Expression Method	Termination Material
S	Pure Silver
C	Pure Copper
N	Three Layers Plating Terminal (Silver or Copper layer/ Nickel layer /Tin layer)

⑦Package Method	
Expression Method	Packaging
No Mark	Bulk Packaging in a Bag
T	Taping Packaging
B	Bulk Plastic Box Packaging

### • Outside Dimension

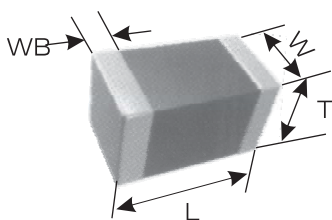

Type		Dimension (mm)			
British expression	Metric expression	L	W	T	WB
0402	1005	$1.00 \pm 0.05$	$0.50 \pm 0.05$	$0.50 \pm 0.05$	$0.25 \pm 0.10$
0603	1608	$1.60 \pm 0.10$	$0.80 \pm 0.10$	$0.80 \pm 0.10$	$0.30 \pm 0.10$
0805	2012	$2.00 \pm 0.20$	$1.25 \pm 0.20$	$0.80 \pm 0.20$ $1.00 \pm 0.20$ $1.25 \pm 0.20$	$0.50 \pm 0.20$
1206	3216	$3.20 \pm 0.30$	$1.60 \pm 0.30$	$0.80 \pm 0.20$ $1.00 \pm 0.20$ $1.25 \pm 0.20$	$0.60 \pm 0.30$

# 多層片式陶瓷電容器

## MULTILAYER CHIP CERAMIC CAPACITOR

- 電容量範圍

項目	通用型Y5V片容																			
尺寸	0402					0603					0805					1206				
工作電壓	6.3V	10V	16V	25V	50V	6.3V	10V	16V	25V	50V	6.3V	10V	16V	25V	50V	6.3V	10V	16V	25V	50V
電容量																				
1000PF																				
1.5nF																				
2.2nF																				
3.3nF																				
4.7nF																				
6.8nF																				
10nF																				
12nF																				
15nF																				
22nF																				
27nF																				
33nF																				
39nF																				
47nF																				
56nF																				
68nF																				
100nF																				
150nF																				
220nF																				
270nF																				
330nF																				
470nF																				
680nF																				
1 μF																				
2.2 μF																				
4.7 μF																				
10 μF																				
22 μF																				
33 μF																				
47 μF																				
100 μF																				

• Capacitance Range

Item	Y5V MLCC for General-use																			
Dimension	0402					0603					0805					1206				
Rated Volatage	6.3V	10V	16V	25V	50V	6.3V	10V	16V	25V	50V	6.3V	10V	16V	25V	50V	6.3V	10V	16V	25V	50V
Capacitance																				
1000PF																				
1.5nF																				
2.2nF																				
3.3nF																				
4.7nF																				
6.8nF																				
10nF																				
12nF																				
15nF																				
22nF																				
27nF																				
33nF																				
39nF																				
47nF																				
56nF																				
68nF																				
100nF																				
150nF																				
220nF																				
270nF																				
330nF																				
470nF																				
680nF																				
1 μ F																				
2.2 μ F																				
4.7 μ F																				
10 μ F																				
22 μ F																				
33 μ F																				
47 μ F																				
100 μ F																				

### ■ 通用型Z5U片容

通用型Z5U片容屬於Ⅱ類低頻電容器，其電容量的穩定性介於X7R和Y5V之間。

#### ● 特性

- \* 在10℃ ~ 85℃工作範圍內，其溫度特性為+22%，-56%。
- \* 疊層獨石結構，具有高可靠性。
- \* 優良的可焊性和耐焊性，適用於回流焊和波峰焊。

#### ● 應用

- \* 適用於各種濾波，耦合線路。
- 產品規格型號表示方法

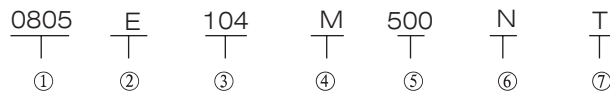

① 尺寸		
型號	英制(英寸)	公制(毫米)
0402	0.04 × 0.02	1.00 × 0.50
0603	0.06 × 0.03	1.60 × 0.80
0805	0.08 × 0.05	2.00 × 1.25

② 介質種類	
代碼	介質材料
E	Z5U

③ 標稱電容量(PF)	
表示方式	實際值
102	10 × 10 <sup>2</sup>
103	10 × 10 <sup>3</sup>
104	10 × 10 <sup>4</sup>

④ 誤差級別	
代碼	誤差
M	± 20%
Z	+80% -20%

⑤ 工作電壓	
表示方法	實際電壓
6R3	6.3V
100	10V
250	25V
500	50V

⑥ 端頭類別	
表示方法	端頭材料
S	純銀端頭
C	純銅端頭
N	三層電鍍端頭 (銀或銅層/鎳層/錫層)

⑦ 包裝方式	
表示方法	包裝
無標記	袋裝散包裝
T	編帶包裝
B	塑料盒散包裝

#### ● 外形尺寸

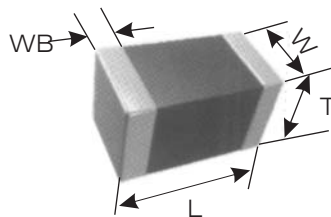

規格型號		尺寸 (mm)			
英制表示	公制表示	L	W	T	WB
0402	1005	1.00 ± 0.05	0.50 ± 0.05	0.50 ± 0.05	0.25 ± 0.10
0603	1608	1.60 ± 0.10	0.80 ± 0.10	0.80 ± 0.10	0.30 ± 0.10
0805	2012	2.00 ± 0.20	1.25 ± 0.20	0.80 ± 0.20 1.00 ± 0.20 1.25 ± 0.20	0.50 ± 0.20

## ■ Z5U MLCC for General-use

Z5U MLCC for General-use is class II low frequency capacitor, its capacitance stability is between that of X7R and Y5V.

### • Features

- \* Its operating temperature is 10°C~85°C, within the range, the temperature coefficient is +22%, -56%.
- \* It has multi-layer monolithic structure, has high reliability.
- \* It has good solderability and soldering resistance, suitable for flow soldering/reflow soldering.

### • Applications

It is suitable for all kinds of filter and coupling circuits.

### • Product Part Number Expression

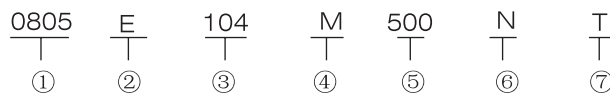

①Dimensions		
Type	British (Inch)	Metric (mm)
0402	0.04×0.02	1.0×0.5
0603	0.06×0.03	1.6×0.8
0805	0.08×0.05	2.0×1.25

②Dielectric Type	
Code	Dielectric
E	Z5U

③Normal Capacitance(PF)	
Expression Method	Actual Value
102	10×10 <sup>2</sup>
103	10×10 <sup>3</sup>
104	10×10 <sup>4</sup>

④Capacitance Tolerance	
Code	Tolerance
M	±20%
Z	+80% -20%

⑤Rated Voltage	
Expression Method	Actual Value
250	25V
500	50V
101	100V
201	200V

⑥Termination Type	
Expression Method	Termination Material
S	Pure Silver
C	Pure Copper
N	Three Layers Plating Terminal (Silver or Copper layer/ Nickel layer /Tin layer)

⑦Package Method	
Expression Method	Packaging
No Mark	Bulk Packaging in a Bag
T	Taping Packaging
B	Bulk Plastic Box Packaging

### • Outside Dimension

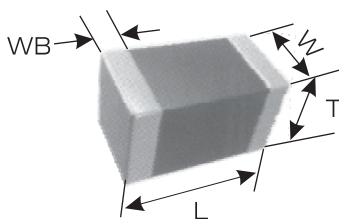

Type		Dimension (mm)			
British expression	Metric expression	L	W	T	WB
0402	1005	1.00±0.05	0.50±0.05	0.50±0.05	0.25±0.10
0603	1608	1.60±0.10	0.80±0.10	0.80±0.10	0.30±0.10
0805	2012	2.00±0.20	1.25±0.20	0.80±0.20 1.00±0.20 1.25±0.20	0.50±0.20

# 多層片式陶瓷電容器

## MULTILAYER CHIP CERAMIC CAPACITOR

- 電容量範圍

項目	通用型Z5U片容														
尺寸	0402					0603					0805				
工作電壓	6.3V	10V	16V	25V	50V	6.3V	10V	16V	25V	50V	6.3V	10V	16V	25V	50V
電容量															
1000PF															
1.5nF															
2.2nF															
3.3nF															
4.7nF															
6.8nF															
10nF															
12nF															
15nF															
22nF															
27nF															
33nF															
39nF															
47nF															
56nF															
68nF															
100nF															
150nF															
220nF															
270nF															
330nF															
470nF															
680nF															
1 μF															
2.2 μF															
4.7 μF															
10 μF															
22 μF															
33 μF															
47 μF															
100 μF															

• Capacitance Range

Item	Z5U MLCC for General-use														
Dimension	0402					0603					0805				
Rated Volatage	6.3V	10V	16V	25V	50V	6.3V	10V	16V	25V	50V	6.3V	10V	16V	25V	50V
Capacitance															
1000PF															
1.5nF															
2.2nF															
3.3nF															
4.7nF															
6.8nF															
10nF															
12nF															
15nF															
22nF															
27nF															
33nF															
39nF															
47nF															
56nF															
68nF															
100nF															
150nF															
220nF															
270nF															
330nF															
470nF															
680nF															
1 μ F															
2.2 μ F															
4.7 μ F															
10 μ F															
22 μ F															
33 μ F															
47 μ F															
100 μ F															



# 多層片式陶瓷電容器

## MULTILAYER CHIP CERAMIC CAPACITOR

### ■ 通用型PH、RH、SH、TH、UJ、SL片容

通用型PH、RH、SH、TH、UJ、SL片容屬於I類電容器。

#### ● 特性

- \* 在-55℃ ~ 85℃工作範圍內,其溫度系數為負值。
- \* 疊層獨石結構,具有高可靠性。
- \* 優良的焊接性和耐焊性,適用於回流焊和波峰焊。

#### ● 應用

- \* 適用於溫度補償型電路。

#### ● 產品規格型號表示方法

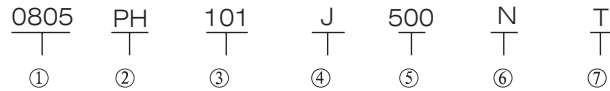

① 尺寸		
型號	英制(英寸)	公制(毫米)
0402	0.04 × 0.02	1.00 × 0.50
0603	0.06 × 0.03	1.60 × 0.80
0805	0.08 × 0.05	2.00 × 1.25

② 介質種類	
代碼	介質材料
PH	PH
RH	RH
SH	SH
TH	TH
UJ	UJ
SL	SL

③ 標稱電容量(PF)	
表示方式	實際值
100	$10 \times 10^0$
101	$10 \times 10^1$
102	$10 \times 10^2$

④ 誤差級別	
代碼	誤差
J	± 5.00%
G	± 2.00%
C	± 0.25PF
B	± 0.10PF
D	± 0.50PF

⑤ 工作電壓	
表示方法	實際電壓
6R3	6.3V
100	10V
250	25V
500	50V

⑥ 端頭類別	
表示方法	端頭材料
S	純銀端頭
C	純銅端頭
N	三層電鍍端頭 (銀或銅層/鎳層/錫層)

⑦ 包裝方式	
表示方法	包裝
無標記	袋裝散包裝
T	編帶包裝
B	塑料盒散包裝

#### ● 外形尺寸

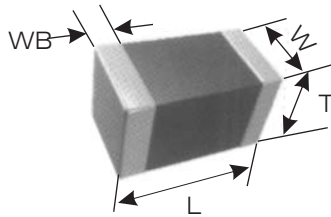

規格型號		尺寸( mm )			
英制表示	公制表示	L	W	T	WB
0402	1005	1.00 ± 0.05	0.50 ± 0.05	0.50 ± 0.05	0.25 ± 0.10
0603	1608	1.60 ± 0.10	0.80 ± 0.10	0.80 ± 0.10	0.30 ± 0.10
0805	2012	2.00 ± 0.20	1.25 ± 0.20	0.80 ± 0.20 1.00 ± 0.20 1.25 ± 0.20	0.50 ± 0.20

## ■ PH、RH、SH、TH、UJ、SL MLCC for General-use

PH、RH、SH、TH、UJ、SL MLCC for General-use is class I capacitor.

### • Features

- \* Its operating temperature is  $-55^{\circ}\text{C}\sim 85^{\circ}\text{C}$ , within the range, the temperature coefficient is  $-150\pm 60\text{PPM}/^{\circ}\text{C}\sim 1400\text{PPM}/^{\circ}\text{C}$ .
- \* It has multi-layer monolithic structure, has high reliability.
- \* It has good solderability and soldering resistance, suitable for flow soldering/reflow soldering.

### • Applications

It is suitable for temperature compensating circuits.

### • Product Part Number Expression

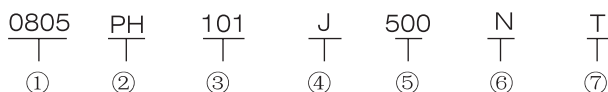

①Dimensions		
Type	British (Inch)	Metric (mm)
0402	0.04×0.02	1.0×0.5
0603	0.06×0.03	1.6×0.8
0805	0.08×0.05	2.0×1.25

②Dielectric Type	
Code	Dielectric
PH	PH
RH	RH
SH	SH
TH	TH
UJ	UJ
SL	SL

③Normal Capacitance(PF)	
Expression Method	Actual Value
100	$10\times 10^0$
101	$10\times 10^1$
102	$10\times 10^2$

④Capacitance Tolerance	
Code	Tolerance
J	±5.00%
G	±2.00%
C	±0.25PF
B	±0.10PF
D	±0.50PF

⑤Rated Voltage	
Expression Method	Actual Value
6R3	6.3V
100	10V
250	25V
500	50V

⑥Termination Type	
Expression Method	Termination Material
S	Pure Silver
C	Pure Copper
N	Three Layers Plating Terminal (Silver or Copper layer/ Nickel layer /Tin layer)

⑦Package Method	
Expression Method	Packaging
No Mark	Bulk Packaging in a Bag
T	Taping Packaging
B	Bulk Plastic Box Packaging

### • Outside Dimension

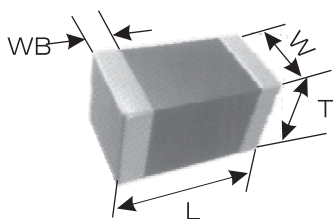

Type		Dimension (mm)			
British expression	Metric expression	L	W	T	WB
0402	1005	$1.00\pm 0.05$	$0.50\pm 0.05$	$0.50\pm 0.05$	$0.25\pm 0.10$
0603	1608	$1.60\pm 0.10$	$0.80\pm 0.10$	$0.80\pm 0.10$	$0.30\pm 0.10$
0805	2012	$2.00\pm 0.20$	$1.25\pm 0.20$	$0.80\pm 0.20$ $1.00\pm 0.20$ $1.25\pm 0.20$	$0.50\pm 0.20$

## 多層片式陶瓷電容器

### MULTILAYER CHIP CERAMIC CAPACITOR

- 電容量範圍

項目	通用型PH片容														
尺寸	0402					0603					0805				
工作電壓	6.3V	10V	16V	25V	50V	6.3V	10V	16V	25V	50V	6.3V	10V	16V	25V	50V
電容量															
0.5PF															
1PF															
2PF															
3PF															
4PF															
5PF															
6PF															
7PF															
8PF															
10PF															
15PF															
18PF															
22PF															
33PF															
47PF															
68PF															
82PF															
100PF															
120PF															
150PF															
180PF															

項目	通用型RH片容														
尺寸	0402					0603					0805				
工作電壓	6.3V	10V	16V	25V	50V	6.3V	10V	16V	25V	50V	6.3V	10V	16V	25V	50V
電容量															
0.5PF															
1PF															
2PF															
3PF															
4PF															
5PF															
6PF															
7PF															
8PF															
10PF															
15PF															
18PF															
22PF															
33PF															
47PF															
68PF															
82PF															
100PF															
120PF															
150PF															
180PF															

• Capacitance Range

Item	PH MLCC for General-use														
Dimension	0402					0603					0805				
Rated Volatage	6.3V	10V	16V	25V	50V	6.3V	10V	16V	25V	50V	6.3V	10V	16V	25V	50V
Capacitance															
0.5PF															
1PF															
2PF															
3PF															
4PF															
5PF															
6PF															
7PF															
8PF															
10PF															
15PF															
18PF															
22PF															
33PF															
47PF															
68PF															
82PF															
100PF															
120PF															
150PF															
180PF															

Item	RH MLCC for General-use														
Dimension	0402					0603					0805				
Rated Volatage	6.3V	10V	16V	25V	50V	6.3V	10V	16V	25V	50V	6.3V	10V	16V	25V	50V
Capacitance															
0.5PF															
1PF															
2PF															
3PF															
4PF															
5PF															
6PF															
7PF															
8PF															
10PF															
15PF															
18PF															
22PF															
33PF															
47PF															
68PF															
82PF															
100PF															
120PF															
150PF															
180PF															

## 多層片式陶瓷電容器

### MULTILAYER CHIP CERAMIC CAPACITOR

項目	通用型SH片容														
	0402					0603					0805				
尺寸															
工作電壓	6.3V	10V	16V	25V	50V	6.3V	10V	16V	25V	50V	6.3V	10V	16V	25V	50V
電容量															
0.5PF															
1PF															
2PF															
3PF															
4PF															
5PF															
6PF															
7PF															
8PF															
10PF															
15PF															
18PF															
22PF															
33PF															
47PF															
68PF															
82PF															
100PF															
120PF															
150PF															
180PF															

項目	通用型TH片容														
	0402					0603					0805				
尺寸															
工作電壓	6.3V	10V	16V	25V	50V	6.3V	10V	16V	25V	50V	6.3V	10V	16V	25V	50V
電容量															
0.5PF															
1PF															
2PF															
3PF															
4PF															
5PF															
6PF															
7PF															
8PF															
10PF															
15PF															
18PF															
22PF															
33PF															
47PF															
68PF															
82PF															
100PF															
120PF															
150PF															
180PF															
220PF															

Item	SH MLCC for General-use														
Dimension	0402					0603					0805				
Rated Volatage	6.3V	10V	16V	25V	50V	6.3V	10V	16V	25V	50V	6.3V	10V	16V	25V	50V
Capacitance															
0.5PF															
1PF															
2PF															
3PF															
4PF															
5PF															
6PF															
7PF															
8PF															
10PF															
15PF															
18PF															
22PF															
33PF															
47PF															
68PF															
82PF															
100PF															
120PF															
150PF															
180PF															

Item	TH MLCC for General-use														
Dimension	0402					0603					0805				
Rated Volatage	6.3V	10V	16V	25V	50V	6.3V	10V	16V	25V	50V	6.3V	10V	16V	25V	50V
Capacitance															
0.5PF															
1PF															
2PF															
3PF															
4PF															
5PF															
6PF															
7PF															
8PF															
10PF															
15PF															
18PF															
22PF															
33PF															
47PF															
68PF															
82PF															
100PF															
120PF															
150PF															
180PF															
220PF															

## 多層片式陶瓷電容器

### MULTILAYER CHIP CERAMIC CAPACITOR

項目	通用型UJ片容														
尺寸	0402					0603					0805				
工作電壓	6.3V	10V	16V	25V	50V	6.3V	10V	16V	25V	50V	6.3V	10V	16V	25V	50V
電容量															
0.5PF															
1PF															
2PF															
3PF															
4PF															
5PF															
6PF															
7PF															
8PF															
10PF															
15PF															
18PF															
22PF															
33PF															
47PF															
68PF															
82PF															
100PF															
120PF															
150PF															
180PF															

項目	通用型SL片容														
尺寸	0402					0603					0805				
工作電壓	6.3V	10V	16V	25V	50V	6.3V	10V	16V	25V	50V	6.3V	10V	16V	25V	50V
電容量															
0.5PF															
1PF															
2PF															
3PF															
4PF															
5PF															
6PF															
7PF															
8PF															
10PF															
15PF															
18PF															
22PF															
33PF															
47PF															
68PF															
82PF															
100PF															
120PF															
150PF															
180PF															
220PF															
330PF															
470PF															
560PF															
680PF															
1000PF															
1500PF															
2200PF															
3300PF															

Item	UJ MLCC for General-use														
Dimension	0402					0603					0805				
Rated Volatage	6.3V	10V	16V	25V	50V	6.3V	10V	16V	25V	50V	6.3V	10V	16V	25V	50V
Capacitance															
0.5PF															
1PF															
2PF															
3PF															
4PF															
5PF															
6PF															
7PF															
8PF															
10PF															
15PF															
18PF															
22PF															
33PF															
47PF															
68PF															
82PF															
100PF															
120PF															
150PF															
180PF															

Item	SL MLCC for General-use														
Dimension	0402					0603					0805				
Rated Volatage	6.3V	10V	16V	25V	50V	6.3V	10V	16V	25V	50V	6.3V	10V	16V	25V	50V
Capacitance															
0.5PF															
1PF															
2PF															
3PF															
4PF															
5PF															
6PF															
7PF															
8PF															
10PF															
15PF															
18PF															
22PF															
33PF															
47PF															
68PF															
82PF															
100PF															
120PF															
150PF															
180PF															
220PF															
330PF															
470PF															
560PF															
680PF															
1000PF															
1500PF															
2200PF															
3300PF															



# 多層片式陶瓷電容器

## MULTILAYER CHIP CERAMIC CAPACITOR

### ■ 通用型COG、COH、PH~SL可靠性測試方法

編號	項目	標準		測試方法									
		通用型COG、COH片容	通用型PH、RH、SH、TH、UJ、SL片容										
1	工作溫度範圍	-55℃ ~ 125℃	-55℃ ~ 85℃										
2	外觀	1. 瓷體顏色一致性好。 2. 芯片無可見損傷,光滑平整。 3. 瓷體無外露電極,裂痕,孔洞。 4. 端電極無裂痕,孔洞,磨損及表面氧化等。 5. 端電極應無延伸現象或延伸部分不超過端頭寬度的一半。		※在 $\geq 10\times$ 倍以上的顯微鏡下觀察。									
3	尺寸	在規定尺寸範圍內		※使用千分尺或游標卡尺。									
4	電容量	在規定偏差範圍內		※測試儀器:HP4278A電橋、HP4284電橋。									
5	損耗因數(D.F.)	$Cr < 5PF \quad < 0.56\%$ $5PF \leq Cr < 50PF \quad 1.5 [(150/Cr)+7] \times 10^{-4}$ $Cr \geq 50PF \quad < 0.15\%$		※測試條件: 1. 測試溫度: $25^\circ C \pm 5^\circ C$ , 濕度: 30% ~ 75%。 2. 測試電壓: $1.0 \pm 0.2V$ 。 3. 測試頻率: $C < 1000PF, 1.0 \pm 0.1MHz$ ; $C \geq 1000PF, 1.0 \pm 0.1KHz$									
6	絕緣電阻 (I.R.)	$C \leq 10nF \quad Ri \geq 5 \times 10^{10} \Omega$ $C > 10nF \quad Ri \cdot Cr \geq 500s$		※測試儀器:絕緣電阻測試儀(如:SF2511絕緣測試機)。 ※測試方法:施加額定工作電壓,在 $60 \pm 5$ 秒內測量絕緣電阻。									
7	耐電壓強度	$> 3 \times$ 額定工作電壓		※施加3倍額定工作電壓,持續1~5秒,未出現擊穿現象并且充電/放電電流低於50mA。									
8	電容量溫度特性	在工作溫度範圍內符合電容器特性溫度系數要求		※首先進行預處理:進行 $150+0/-10^\circ C$ 熱處理 $60 \pm 5$ 分鐘,然后在室溫條件下放置 $24 \pm 2$ 小時。 ※在 $-55 \sim 125^\circ C$ 或者 $-55 \sim 85^\circ C$ 範圍內測試電容量,其電容值相對於 $20^\circ C$ 時數值的變化率應在規定範圍內。									
9	可焊性	75% 端電極覆蓋錫		※將電容器浸在乙醇和松香溶液中。然後浸入有鉛 $235 \pm 5^\circ C$ (無鉛 $245 \pm 5^\circ C$ ) 的混合焊錫溶液 $2 \pm 0.5$ 秒。浸入速度: $25 \pm 2.5mm/秒$ 。									
10	耐焊接熱	外觀 電容量變化率 D.F. I.R.	無明顯缺陷 $\leq \pm 5\%$ 或 $\pm 0.5PF$ 取兩者中最大的 同初始標準 同初始標準	※首先進行預處理:進行 $150+0/-10^\circ C$ 熱處理 $60 \pm 5$ 分鐘,然后在室溫條件下放置 $24 \pm 2$ 小時。 ※然後按下表預熱電容器。將電容器浸入 $265 \pm 5^\circ C$ 的混合焊錫溶液 $10 \pm 1$ 秒。再在室溫條件下放置 $24 \pm 2$ 小時,然後進行測量。 浸入速度: $25 \pm 2.5mm/秒$ 。 ※預熱條件如下: <table border="1" style="margin-left: 20px;"> <thead> <tr> <th>階段</th> <th>溫度</th> <th>時間</th> </tr> </thead> <tbody> <tr> <td>1</td> <td><math>100^\circ C - 120^\circ C</math></td> <td>1分鐘</td> </tr> <tr> <td>2</td> <td><math>170^\circ C - 200^\circ C</math></td> <td>1分鐘</td> </tr> </tbody> </table>	階段	溫度	時間	1	$100^\circ C - 120^\circ C$	1分鐘	2	$170^\circ C - 200^\circ C$	1分鐘
階段	溫度	時間											
1	$100^\circ C - 120^\circ C$	1分鐘											
2	$170^\circ C - 200^\circ C$	1分鐘											

• General COG、COH、PH~SL MLCC reliability test method

Number	Item	Standard		Test Method
		COG、COH MLCC for General-use	PH, RH, SH, TH, UJ, SL MLCC for General-use	
1	Operating Temperature Range	-55℃~125℃	-55℃~85℃	
2	Appearance	1.Good ceramic body color continuity. 2.The chips have no visual damages and must be very smooth. 3.No exposed inner- electrode, no cracks or holes. 4.The outer electrode should have no cracks, holes, damages or surface oxidation. 5.Outer electrode no prolongation or the prolongation is less than half of that of the termination width.		※Check by using microscope $\geq 10\times$ .
3	Dimensions	Within the specified dimensions		※Using micrometer or vernier calipers
4	Capacitance	Within the specified tolerance		※Measuring Equipments:HP4278 capacitance meter,HP4284 capacitance,
5	Dissipation Factor (DF)	$Cr < 5PF \leq 0.56\%$ $5PF < Cr < 50PF \ 1.5 [(150/Cr)+7] \times 10^{-4}$ $Cr \geq 50PF \leq 0.15\%$		※Measuring Conditions: 1.Measuring Temperature:25℃ ± 5℃.Humidity: 30% ~ 75%. 2.Measuring Voltage:1.0 ± 0.2V. 3.Measuring Frequency:C<1000PF, 1.0 ± 0.1MHz C ≥ 1000PF, 1.0 ± 0.1KHz
6	Insulation Resistance	$C \leq 10nF \ Ri \geq 5 \times 10^{10} \ \Omega$ $C > 10nF \ Ri \cdot Cr \geq 500s$		※Measuring Equipment:Insulation resistance meter (such as Sf2511 insulation resistance). ※Measuring Method:Must measure at rated voltage, and measure the IR within 60±5 seconds.
7	Withstanding Voltage	>3x rated continuous working voltage		※Must measure at 3 times rated voltage, dwell time: 1~5 seconds, no short and the changing/discharging current less than 50mA.
8	Capacitance Temperature Characteristic	Must meet the capacitor character temperature coefficient requirements within the operating temperature range.		※First, pre-heat: heat treat 60±5 minutes at 150+0/-10℃, then set it for 24±2 hours at room temperature. ※Measure the capacitance at -55~125℃ or -55~85℃, the capacitance change ratio comparing to that of 25℃ must be within the specified range.
9	Solderability	Tin coverage should be 75% of the outer electrode		※Dip the capacitor into ethanol or colophony solution, and then dip it into 235±5℃ ( or 245±5℃ leadless eutectic solder solution ) eutectic solder solution having lead for 2±0.5 seconds. Dipping speed: 25±2.5mm/second.
10	Resistance to Soldering	Appearance	No defects visible	※First pre-heat: heat treat for 60±5 minutes at 150+0/-10℃, then set it for 24±2 hours at room temperature. ※Then pre-heat the capacitance according to the following chart. Dip the capacitor into 265±5℃ eutectic solder solution for 10±1 seconds. Then set it for 24±2 hours at room temperature, then measure. Dipping speed: 25±2.5mm/second. ※Preheat conditions:
		Cap. Change ratio	$\leq \pm 5\%$ or $\pm 0.5PF$ (whichever is larger)	
		DF	Same as original spec	
		IR	Same as original spec	

Stage	Temperature	Time
1	100℃—120℃	1 minute
2	170℃—200℃	1 minute

# 多層片式陶瓷電容器

## MULTILAYER CHIP CERAMIC CAPACITOR

編號	項目	標準		測試方法																						
11	端電極結合強度	不應出現端頭脫落或其它缺陷。		<p>※使用混合焊錫將電容器焊接在圖 1 中所示的測試夾具(玻璃環氧樹脂板)上。然後沿箭頭方向施加 10N 的力。焊接應利用烙鐵或使用回流焊方法進行,而且應謹慎作業,以使焊接均勻且不會出現熱衝擊等不良現象。</p>  <p>圖 1</p>																						
12	耐振動性	外觀	無明顯缺陷	<p>※將電容器焊接在測試夾具(玻璃環氧樹脂板)上。電容器應進行簡諧運動,其總幅值為 1.5mm,頻率在近似 10—55Hz 之間均勻變化。頻率範圍(從 10 至 55Hz 再返回 10Hz)應在約 1 分鐘內完成。振動應在三個相互垂直方向各進行 2 小時(總計 6 小時)。</p>  <p>圖 2</p>																						
		電容量	在規定偏差範圍內																							
		D.F.	同初始標準																							
13	抗彎曲性	不應出現裂縫或其他缺陷。		<p>※使用混合焊錫將電容器焊接在圖 3 中所示的測試夾具(玻璃環氧樹脂板)上,然後在圖 4 所示的方向加力。焊接應利用烙鐵或使用回流焊方法進行,而且應謹慎作業,以使焊接均勻且不會出現熱衝擊等不良現象。</p>  <p>圖 3</p>  <p>圖 4</p> <table border="1" data-bbox="901 1556 1252 1713"> <thead> <tr> <th rowspan="2">L×W (mm)</th> <th colspan="4">尺寸 (mm)</th> </tr> <tr> <th>a</th> <th>b</th> <th>c</th> <th>d</th> </tr> </thead> <tbody> <tr> <td>4.5×2.0</td> <td>3.5</td> <td>7.0</td> <td>2.4</td> <td rowspan="3">1.0</td> </tr> <tr> <td>4.5×3.2</td> <td>3.5</td> <td>7.0</td> <td>3.7</td> </tr> <tr> <td>5.7×6.3</td> <td>4.5</td> <td>8.0</td> <td>5.6</td> </tr> </tbody> </table>	L×W (mm)	尺寸 (mm)				a	b	c	d	4.5×2.0	3.5	7.0	2.4	1.0	4.5×3.2	3.5	7.0	3.7	5.7×6.3	4.5	8.0	5.6
L×W (mm)	尺寸 (mm)																									
	a	b	c	d																						
4.5×2.0	3.5	7.0	2.4	1.0																						
4.5×3.2	3.5	7.0	3.7																							
5.7×6.3	4.5	8.0	5.6																							
14	溫度循環	外觀	無缺陷或異常	<p>※首先進行預處理: 進行 150+0/-10℃ 熱處理 60 ± 5 分鐘,然後在室溫條件下放置 24 ± 2 小時。</p> <p>※按照下表中列出的四種熱處理方法執行五次循環。</p> <p>在室溫條件下放置 24 ± 2 小時,然後進行測量。</p>																						

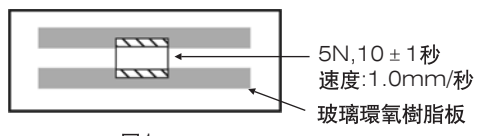
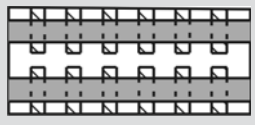
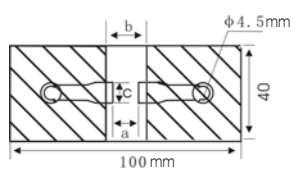
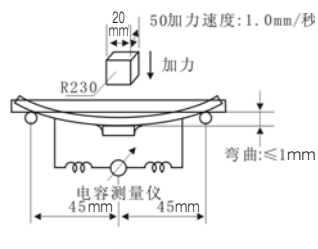
Number	Items	Standard		Test Method																						
11	Adhesive Strength of Termination	No removal of the terminations or other defect shall occur		<p>※Solder the capacitor to the test jig (glass epoxy resin board) shown in Fig.1 using a eutectic solder. Then apply a 10N force in the direction shown as the arrowhead. The soldering shall be done either with an iron or using the reflow method and shall be conducted with care so that the soldering is uniform and free of defects such as heat shock, etc.</p> <p>5N, 10 ± 1s Speed: 1.0mm/s Glass epoxy resinboard</p> <p>Fig.1</p>																						
12	Vibration Resistance	Appearance	No defects or abnormalities	<p>※Solder the capacitor to the test jig (glass epoxy resin board). The capacitor should be subjected to a simple harmonic motion having a total amplitude of 1.5mm, the frequency being varied uniformly between the approximate limits of 10 and 55Hz, shall be traversed (from 10 Hz to 55 Hz then 10 Hz again) in approximately 1 minute. This motion shall be applied for a period of 2 hours in each 3 mutually perpendicular directions (total is 6 hours).</p> <p>Fig.2</p>																						
		Capacitance	Within the specified tolerance range																							
		DF	Same as original spec																							
13	Bending Resistance	No cracks or other defects shall occur		<p>※Solder the capacitor to the test jig (glass epoxy resin board) shown in Fig.3 using a eutectic solder. Then apply a 10N force in the direction shown as Fig.4. The soldering shall be done either with an iron or using the reflow method and shall be conducted with care so that the soldering is uniform and free of defects such as heat shock, etc.</p> <p>Fig.3</p> <p>Fig.4</p> <table border="1"> <thead> <tr> <th rowspan="2">L×W (mm)</th> <th colspan="4">Dimension</th> </tr> <tr> <th>a</th> <th>b</th> <th>c</th> <th>d</th> </tr> </thead> <tbody> <tr> <td>4.5×2.0</td> <td>3.5</td> <td>7.0</td> <td>2.4</td> <td rowspan="3">1.0</td> </tr> <tr> <td>4.5×3.2</td> <td>3.5</td> <td>7.0</td> <td>3.7</td> </tr> <tr> <td>5.7×6.3</td> <td>4.5</td> <td>8.0</td> <td>5.6</td> </tr> </tbody> </table>	L×W (mm)	Dimension				a	b	c	d	4.5×2.0	3.5	7.0	2.4	1.0	4.5×3.2	3.5	7.0	3.7	5.7×6.3	4.5	8.0	5.6
L×W (mm)	Dimension																									
	a	b	c	d																						
4.5×2.0	3.5	7.0	2.4	1.0																						
4.5×3.2	3.5	7.0	3.7																							
5.7×6.3	4.5	8.0	5.6																							
14	Temperature Cycle	Appearance	No defects or abnormalities	<p>※Pre-treatment: Heat-treat the capacitor for 60 ± 5 minutes at 150+0/-10°C, then set it for 24 ± 2 hours at room temperature.</p> <p>※Perform five cycles according to the four heat treatments listed in the following table. Set it for 24 ± 2 hours at room temperature, then measure.</p>																						

## 多層片式陶瓷電容器

## MULTILAYER CHIP CERAMIC CAPACITOR

編號	項目	標準		測試方法															
14	溫度循環	$\Delta C/C \leq \pm 1\%$ 或 $1PF$ , 取兩者中最大值		熱處理方法如下表: <table border="1"> <thead> <tr> <th>階段</th> <th>溫度(°C)</th> <th>時間(分鐘)</th> </tr> </thead> <tbody> <tr> <td>1</td> <td>最低工作溫度 <math>\pm 3</math></td> <td><math>30 \pm 3</math></td> </tr> <tr> <td>2</td> <td>常溫</td> <td>2—3</td> </tr> <tr> <td>3</td> <td>最高工作溫度 <math>\pm 2</math></td> <td><math>30 \pm 3</math></td> </tr> <tr> <td>4</td> <td>常溫</td> <td>2—3</td> </tr> </tbody> </table>	階段	溫度(°C)	時間(分鐘)	1	最低工作溫度 $\pm 3$	$30 \pm 3$	2	常溫	2—3	3	最高工作溫度 $\pm 2$	$30 \pm 3$	4	常溫	2—3
階段	溫度(°C)	時間(分鐘)																	
1	最低工作溫度 $\pm 3$	$30 \pm 3$																	
2	常溫	2—3																	
3	最高工作溫度 $\pm 2$	$30 \pm 3$																	
4	常溫	2—3																	
15	濕度(穩態)	外觀	無缺陷或異常	※在 $40 \pm 2^\circ C$ 和 90—95% 相對濕度條件下放置 $500 \pm 24/-0$ 小時。 然後將其移動到室溫條件下恢復放置 $24 \pm 2$ 小時，進行測量。															
		電容量	$\leq \pm 2\%$ 或 $\pm 1PF$ , 取兩者中最大的。																
		D.F.	$\leq 2$ 倍初始標準																
		I.R.	大於 $2500M\Omega$																
16	濕度負荷	外觀	無缺陷或異常	※在 $40 \pm 2^\circ C$ 和 90—95% 相對濕度條件下施加額定電壓 $500 \pm 24/-0$ 小時。然後將其移動到室溫條件下放置 $24 \pm 2$ 小時， 進行測量。															
		電容量	$\leq \pm 2\%$ 或 $\pm 1PF$ , 取兩者中最大的。																
		D.F.	$\leq 2$ 倍初始標準																
		I.R.	大於 $2500M\Omega$																
17	壽命	外觀	無缺陷或異常	※在上限溫度下施加 1.5 倍的額定工作電壓 $1000 \pm 12$ 小時，充放電電 流不超過 50mA。將其移動到室溫條件下恢復放置 $24 \pm 2$ 小時， 進行測量。															
		電容量	$\leq \pm 2\%$ 或 $\pm 1PF$ , 取兩者中最大的。																
		D.F.	$\leq 2$ 倍初始標準																
		I.R.	大於 $4000M\Omega$ 或 $R_i \cdot CR \geq 40S$																

Number	Item	Standard		Test Method											
14	Temperature Cycle	Cap. Change ratio	$\leq \pm 2\%$ or $\pm 1$ PF (whichever is larger)	※Heat-treatment:											
				<table border="1"> <thead> <tr> <th>stage</th> <th>temperature (°C)</th> <th>time (min.)</th> </tr> </thead> <tbody> <tr> <td>1</td> <td>lowest operating temperature <math>\pm 3</math></td> <td><math>30 \pm 3</math></td> </tr> <tr> <td>2</td> <td>normal temperature</td> <td>2—3</td> </tr> <tr> <td>3</td> <td>high operating temperature <math>\pm 2</math></td> <td><math>30 \pm 3</math></td> </tr> <tr> <td>4</td> <td>normal temperature</td> <td>2—3</td> </tr> </tbody> </table>	stage	temperature (°C)	time (min.)	1	lowest operating temperature $\pm 3$	$30 \pm 3$	2	normal temperature	2—3	3	high operating temperature $\pm 2$
stage	temperature (°C)	time (min.)													
1	lowest operating temperature $\pm 3$	$30 \pm 3$													
2	normal temperature	2—3													
3	high operating temperature $\pm 2$	$30 \pm 3$													
4	normal temperature	2—3													
15	Humidity Steady State	Appearance	No defects or abnormalities	※Set the capacitor for $500+24/-0$ hours at the condition of $40 \pm 2^\circ\text{C}$ and 90-95% humidity. Then remove and set it for $24 \pm 2$ hours at room temperature, then measure.											
		Cap. Change ratio	$\leq \pm 2\%$ or $\pm 1$ PF (whichever is larger)												
		D.F.	Not more than twice of initial value												
		I.R.	More than $2500\text{M}\Omega$												
16	Humidity Load	Appearance	No defects or abnormalities	※Apply rated voltage to the capacitor for $500+24/-0$ hours at the condition of $40 \pm 2^\circ\text{C}$ and 90-95% humidity. Remove and set it for $24 \pm 2$ hours at room temperature, then measure.											
		Cap. Change ratio	$\leq \pm 2\%$ or $\pm 1$ PF (whichever is larger)												
		D.F.	Not more than twice of initial value												
		I.R.	More than $2500\text{M}\Omega$												
17	Life Test	Appearance	No defects or abnormalities	※Apply 1.5 times rated voltage to the capacitor for $1000 \pm 12$ hours at the upper temperature limits, the charging current should be less than 50mA. Remove and set it for $24 \pm 2$ hours at room temperature, then measure.											
		Cap. Change ratio	$\leq \pm 2\%$ or $\pm 1$ PF (whichever is larger)												
		D.F.	Not more than twice of initial value												
		I.R.	More than $4000\text{M}\Omega$ or $R_i \cdot CR \geq 40S$												

## 多層片式陶瓷電容器

### MULTILAYER CHIP CERAMIC CAPACITOR

#### ■ 通用型X7R、X5R、Z5U、Y5V可靠性測試方法

編號	項目	標準		測試方法
1	工作溫度範圍	X5R: -55°C ~ 85°C X7R: -55°C ~ 125°C	Z5U: 10°C ~ 85°C Y5V: -25°C ~ 85°C	
2	外觀	1. 瓷體顏色一致性好。 2. 芯片無可見損傷,光滑平整。 3. 瓷體無外露電極,裂痕,孔洞。 4. 端電極無裂痕,孔洞,磨損及表面氧化等。 5. 端電極應無延伸現象或延伸部分不超過端頭寬度的一半。		※在 $\geq 10$ 倍以上的顯微鏡下觀察。
3	尺寸	在規定尺寸範圍內		※使用千分尺或游標卡尺。
4	電容量	在規定偏差範圍內		※測試儀器: HP4278A電橋、HP4284電橋。
5	損耗因數(D.F.)	X5R,X7R	Z5U,Y5V	※測試條件: 1. 測試溫度: $25^{\circ}\text{C} \pm 5^{\circ}\text{C}$ , 濕度: 30% ~ 75%。 2. 測試電壓: $1.0 \pm 0.2\text{V}$ , (Y5V) $0.5 \pm 0.2\text{V}$ (Z5U)。 3. 測試頻率: $1.0 \pm 0.1\text{KHz}$ 。
		$U_r \geq 50\text{V}$ , $D_f \leq 250 \times 10^{-4}$ $U_r = 25\text{V}, 16\text{V}, 10\text{V}$ : $C < 0.47\mu\text{F}$ , $DF \leq 350 \times 10^{-4}$ $C \geq 0.47\mu\text{F}$ , $DF \leq 1000 \times 10^{-4}$ $U_r = 6.3\text{V}$ : $C < 0.15\mu\text{F}$ , $D_f \leq 500 \times 10^{-4}$ $C \geq 0.15\mu\text{F}$ , $DF \leq 1000 \times 10^{-4}$	$U_r \geq 25\text{V}$ : $C < 1.0 \mu\text{F}$ , $DF \leq 700 \times 10^{-4}$ $C \geq 1.0 \mu\text{F}$ , $DF \leq 900 \times 10^{-4}$ $U_r = 16\text{V}, 10\text{V}, 6.3\text{V}$ : $DF \leq 1500 \times 10^{-4}$	
6	絕緣電阻 (I.R.)	$C \leq 25\text{nF}$ , $IR \geq 10000\text{M}\Omega$ $C > 25\text{nF}$ , $R \times C \geq 100\text{S}$	$C \leq 25\text{nF}$ , $IR \geq 4000\text{M}\Omega$ $C > 25\text{nF}$ , $R \times C \geq 100\text{S}$	※測試儀器: 絕緣電阻測試儀(如: SF2511絕緣測試機)。 ※測試方法: 施加額定工作電壓, 在 $60 \pm 5$ 秒內測量絕緣電阻。
7	耐電壓強度	$> 2.5 \times$ 額定工作電壓		※施加 2.5 倍額定工作電壓, 持續 1~5 秒, 未出現擊穿現象並且充電 / 放電電流低於 50mA。
8	電容量溫度特性	在工作溫度範圍內符合電容器特性溫度系數要求		※首先進行預處理: 進行 $150 \pm 0/-10^{\circ}\text{C}$ 熱處理 $60 \pm 5$ 分鐘, 然后在室溫條件下放置 $24 \pm 2$ 小時。 ※在 $-55 \sim 125^{\circ}\text{C}$ 或者 $-55 \sim 85^{\circ}\text{C}$ (X7R, X5R); $-25^{\circ}\text{C} \sim 85^{\circ}\text{C} + 10^{\circ}\text{C} \sim 85^{\circ}\text{C}$ (Y5V ~ Z5U) 範圍內測試電容量, 其電容值相對於 $20^{\circ}\text{C}$ 時數值的變化率應在規定範圍內。
9	可焊性	75% 端電極覆蓋錫		※將電容器浸在乙醇和松香溶液中。 然後浸入有鉛 $235 \pm 5^{\circ}\text{C}$ (無鉛 $245 \pm 5^{\circ}\text{C}$ ) 的混合焊錫溶液 $2 \pm 0.5$ 秒。 浸入速度: $25 \pm 2.5\text{mm/秒}$ 。

● X7R, X5R, Z5U, Y5V MLCC for general use reliability test method

Number	Item	Standard		Test Method
1	Operating Temperature Range	X5R: -55°C ~ 85°C X7R: -55°C ~ 125°C	Z5U: 10°C ~ 85°C Y5V: -25°C ~ 85°C	
2	Appearance	1. Good ceramic body color continuity. 2. The chips have no visual damages and must be very smooth. 3. No exposed inner- electrode, no cracks or holes. 4. The outer electrode should have no cracks, holes, damages or surface oxidation. 5. Outer electrode no prolongation or the prolongation is less than half of that of the termination width.		※Check by using microscope $\geq 10 \times$ .
3	Dimensions	Within the specified dimensions		※Using micrometer or vernier calipers
4	Capacitance)	Within the specified tolerance		※ Measuring Equipments: HP4278 capacitance meter, HP4284 capacitance, ※ Measuring Conditions: 1. Measuring Temperature: $25^{\circ}\text{C} \pm 5^{\circ}\text{C}$ . Humidity: 30% ~ 75%. 2. Measuring Voltage: $1.0 \pm 0.2\text{V}$ . 3. Measuring Frequency: $1.0 \pm 0.1\text{MHz}$
5	Dissipation Factor (DF)	X5R, X7R	Z5U, Y5V	
		$U_r \geq 50\text{V}$ , $D_f \leq 250 \times 10^{-4}$ $U_r = 25\text{V}, 16\text{V}, 10\text{V}$ : $C < 0.47\mu\text{F}$ , $DF \leq 350 \times 10^{-4}$ $C \geq 0.47\mu\text{F}$ , $DF \leq 1000 \times 10^{-4}$ $U_r = 6.3\text{V}$ : $C < 0.15\mu\text{F}$ , $D_f \leq 500 \times 10^{-4}$ $C \geq 0.15\mu\text{F}$ , $DF \leq 1000 \times 10^{-4}$	$U_r \geq 25\text{V}$ : $C < 1.0 \mu\text{F}$ , $DF \leq 700 \times 10^{-4}$ $C \geq 1.0 \mu\text{F}$ , $DF \leq 900 \times 10^{-4}$ $U_r = 16\text{V}, 10\text{V}, 6.3\text{V}$ : $D_f \leq 1500 \times 10^{-4}$	
6	Insulation Resistance	$C \leq 25\text{nF}$ , $IR \geq 10000\text{M}\Omega$ $C > 25\text{nF}$ , $R \times C \geq 100\text{S}$	$C \leq 25\text{nF}$ , $IR \geq 40000\text{M}\Omega$ $1C > 25\text{nF}$ , $R \times C \geq 100\text{S}$	※ Measuring Equipment: Insulation resistance meter (such as Sf2511 insulation resistance). ※ Measuring Method: Must measure at rated voltage, and measure the IR within $60 \pm 5$ seconds.
7	Withstanding Voltage	$> 2.5U_r$		※ Must measure at 2.5 times rated voltage, dwell time: 1~5 seconds, no short and the changing/discharging current less than 50mA.
8	Capacitance Temperature Characteristic	Must meet the capacitor character temperature coefficient requirements within the operating temperature range.		※ First, pre-heat: heat treat $60 \pm 5$ minutes at $150 \pm 0 / -10^{\circ}\text{C}$ , then set it for $24 \pm 2$ hours at room temperature. ※ Measure the capacitance at $-55 \sim 125^{\circ}\text{C}$ or $-55 \sim 85^{\circ}\text{C}$ , the capacitance change ratio comparing to that of $20^{\circ}\text{C}$ must be within the specified range.
9	Solderability	Tin coverage should be 75% of the outer electrode		※ Dip the capacitor into ethanol or colophony solution, and then dip it into $245 \pm 5^{\circ}\text{C}$ eutectic solder solution for $2 \pm 0.5$ seconds. Dipping speed: $25 \pm 2.5\text{mm/second}$ .



# 多層片式陶瓷電容器

## MULTILAYER CHIP CERAMIC CAPACITOR

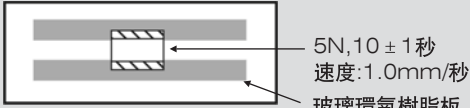
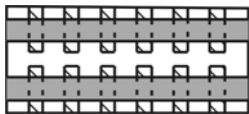
編號	項目	標準		測試方法
10	耐焊接熱	外觀	無明顯缺陷	※首先進行預處理：進行 $150 \pm 0 / -10^{\circ}\text{C}$ 熱處理 $60 \pm 5$ 分鐘，然后在室溫條件下放置 $24 \pm 2$ 小時。 ※然後按下表預熱電容器。將電容器浸入 $265 \pm 5^{\circ}\text{C}$ 的混合焊錫溶液 $10 \pm 1$ 秒。再在室溫條件下放置 $24 \pm 2$ 小時，然後進行測量。 浸入速度： $25 \pm 2.5\text{mm/秒}$ 。 ※預熱條件如下：
		電容量變化率	X7R, X5R: $-5 \sim +10\%$ Z5U, Y5V: $-10 \sim +20\%$	
		D.F.	同初始標準	
		I.R.	同初始標準	
11	端電極結合強度	不應出現端電極脫落或其它缺陷。		※使用混合焊錫將電容器焊接在圖 1 中所示的測試夾具（玻璃環氧樹脂板）上。然後沿箭頭方向施加 $10\text{N}$ 的力。焊接應利用烙鐵或使用回流焊方法進行，而且應謹慎作業，以使焊接均勻且不會出現熱衝擊等不良現象。
		 <p>5N, <math>10 \pm 1</math> 秒 速度: <math>1.0\text{mm/秒}</math> 玻璃環氧樹脂板</p>		圖1
12	耐振動性	外觀	無缺陷或異常	※將電容器焊接在測試夾具（玻璃環氧樹脂板）上。電容器應進行簡諧運動，其總幅值為 $1.5\text{mm}$ ，頻率在近似 $10 \sim 55\text{Hz}$ 之間均勻變化。頻率範圍（從 $10$ 至 $55\text{Hz}$ 再返回 $10\text{Hz}$ ）應在約 1 分鐘內完成。振動應在三個相互垂直方向各進行 2 小時（總計 6 小時）。
		電容量	在規定偏差範圍內	
		D.F.	同初始標準	
13	抗彎曲性能	不應出現裂痕或其他缺陷		※使用混合焊錫將電容器焊接在圖 3 中所示的測試夾具（玻璃環氧樹脂板）上，然後在圖 4 所示的方向加力。焊接應利用烙鐵或使用回流焊方法進行，而且應謹慎作業，以使焊接均勻且不會出現熱衝擊等不良現象。
				圖2

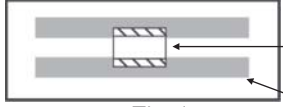
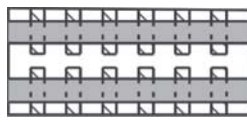
Number	Item	Standard		Test Method									
10	Resistance to Soldering	Appearance	No defects visible	※First pre-heat: heat treat for $60 \pm 5$ minutes at $150 \pm 0/-10^\circ\text{C}$ , then set it for $24 \pm 2$ hours at room temperature. ※Then pre-heat the capacitance according to the following chart. Dip the capacitor into $265 \pm 5^\circ\text{C}$ eutectic solder solution for $10 \pm 1\text{s}$ . Then set it for $24 \pm 2$ hours at room temperature, then measure. Dipping speed: $25 \pm 2.5\text{mm/second}$ . ※Preheat conditions: <table border="1" style="margin-left: 20px;"> <thead> <tr> <th>Stage</th> <th>Temperature</th> <th>Time</th> </tr> </thead> <tbody> <tr> <td>1</td> <td><math>100^\circ\text{C} - 120^\circ\text{C}</math></td> <td>1 minute</td> </tr> <tr> <td>2</td> <td><math>170^\circ\text{C} - 200^\circ\text{C}</math></td> <td>1 minute</td> </tr> </tbody> </table>	Stage	Temperature	Time	1	$100^\circ\text{C} - 120^\circ\text{C}$	1 minute	2	$170^\circ\text{C} - 200^\circ\text{C}$	1 minute
		Stage	Temperature		Time								
		1	$100^\circ\text{C} - 120^\circ\text{C}$		1 minute								
		2	$170^\circ\text{C} - 200^\circ\text{C}$		1 minute								
Cap. Change ratio	X7R, X5R: within $-5 \sim +10\%$ Z5U, Y5V: within $-10 \sim +20\%$												
DF	Same as original spec.												
		IR	Same as original spec.										
11	Adhesive Strength of Termination	No removal of the terminations or other defect shall occur		※Solder the capacitor to the test jig (glass epoxy resin board) shown in Fig.1 using a eutectic solder. Then apply a 10N force in the direction shown as the arrowhead. The soldering shall be done either with an iron or using the reflow method and shall be conducted with care so that the soldering is uniform and free of defects such as heat shock, etc. <div style="text-align: center;">  <p>5N, <math>10 \pm 1\text{s}</math> Speed: <math>1.0\text{mm/s}</math> Glass epoxy resinboard</p> </div> <p>Fig.1</p>									
12	Resistance to Vibration	Appearance	No defects or abnormalities	※Solder the capacitor to the test jig (glass epoxy resin board). The capacitor should be subjected to a simple harmonic motion having a total amplitude of 1.5mm, the frequency being varied uniformly between the approximate limits of 10 and 55Hz, shall be traversed (from 10 Hz to 55 Hz then 10 Hz again) in approximately 1 minute. This motion shall be applied for a period of 2 hours in each 3 mutually perpendicular directions (total is 6 hours). <div style="text-align: center;">  </div> <p>Fig.2</p>									
		Capacitance	Within the specified tolerance range										
		D.F.	Same as original spec.										
13	Bending Resistance	No cracks or other defects shall occur		※Solder the capacitor to the test jig (glass epoxy resin board) shown in Fig.3 using a eutectic solder. Then apply a 10N force in the direction shown as Fig.4. The soldering shall be done either with an iron or using the reflow method and shall be conducted with care so that the soldering is uniform and free of defects such as heat shock, etc.									

# 多層片式陶瓷電容器

## MULTILAYER CHIP CERAMIC CAPACITOR

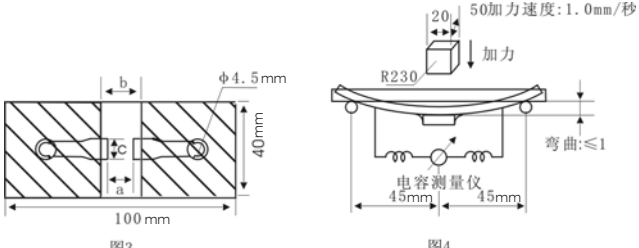
編號	項目	標準	測試方法																							
13	抗彎曲性能	電容量變化率: 在 ± 10% 範圍內	 <p>圖3</p> <p>圖4</p> <table border="1" data-bbox="906 660 1252 801"> <thead> <tr> <th rowspan="2">L×W (mm)</th> <th colspan="4">尺寸 (mm)</th> </tr> <tr> <th>a</th> <th>b</th> <th>c</th> <th>d</th> </tr> </thead> <tbody> <tr> <td>4.5×2.0</td> <td>3.5</td> <td>7.0</td> <td>2.4</td> <td rowspan="3">1.0</td> </tr> <tr> <td>4.5×3.2</td> <td>3.5</td> <td>7.0</td> <td>3.7</td> </tr> <tr> <td>5.7×6.3</td> <td>4.5</td> <td>8.0</td> <td>5.6</td> </tr> </tbody> </table>	L×W (mm)	尺寸 (mm)				a	b	c	d	4.5×2.0	3.5	7.0	2.4	1.0	4.5×3.2	3.5	7.0	3.7	5.7×6.3	4.5	8.0	5.6	
L×W (mm)	尺寸 (mm)																									
	a	b	c	d																						
4.5×2.0	3.5	7.0	2.4	1.0																						
4.5×3.2	3.5	7.0	3.7																							
5.7×6.3	4.5	8.0	5.6																							
14	溫度循環	<table border="1"> <tr> <td>外觀</td> <td>無缺陷或異常</td> </tr> <tr> <td>電容量變化率</td> <td>X7R, X5R: 在 ± 10% 範圍內 Z5U, Y5V: 在 ± 20% 範圍內</td> </tr> <tr> <td>D.F.</td> <td>同初始標準</td> </tr> <tr> <td>I.R.</td> <td>同初始標準</td> </tr> </table>	外觀	無缺陷或異常	電容量變化率	X7R, X5R: 在 ± 10% 範圍內 Z5U, Y5V: 在 ± 20% 範圍內	D.F.	同初始標準	I.R.	同初始標準	<table border="1"> <thead> <tr> <th>階段</th> <th>溫度 ( °C )</th> <th>時間 ( 分鐘 )</th> </tr> </thead> <tbody> <tr> <td>1</td> <td>最低工作溫度 ± 3</td> <td>30 ± 3</td> </tr> <tr> <td>2</td> <td>常溫</td> <td>2—3</td> </tr> <tr> <td>3</td> <td>最高工作溫度 ± 2</td> <td>30 ± 3</td> </tr> <tr> <td>4</td> <td>常溫</td> <td>2—3</td> </tr> </tbody> </table>	階段	溫度 ( °C )	時間 ( 分鐘 )	1	最低工作溫度 ± 3	30 ± 3	2	常溫	2—3	3	最高工作溫度 ± 2	30 ± 3	4	常溫	2—3
外觀	無缺陷或異常																									
電容量變化率	X7R, X5R: 在 ± 10% 範圍內 Z5U, Y5V: 在 ± 20% 範圍內																									
D.F.	同初始標準																									
I.R.	同初始標準																									
階段	溫度 ( °C )	時間 ( 分鐘 )																								
1	最低工作溫度 ± 3	30 ± 3																								
2	常溫	2—3																								
3	最高工作溫度 ± 2	30 ± 3																								
4	常溫	2—3																								
15	濕度(穩態)	<table border="1"> <tr> <td>外觀</td> <td>無缺陷或異常</td> </tr> <tr> <td>電容量變化率</td> <td>X7R, X5R: 在 ± 10% 範圍內 Z5U, Y5V: 在 ± 30% 範圍內</td> </tr> <tr> <td>D.F.</td> <td>≤ 2倍初始標準</td> </tr> <tr> <td>I.R.</td> <td>Ri ≥ 1000MΩ 或 Ri * Cr ≥ 25S</td> </tr> </table>	外觀	無缺陷或異常	電容量變化率	X7R, X5R: 在 ± 10% 範圍內 Z5U, Y5V: 在 ± 30% 範圍內	D.F.	≤ 2倍初始標準	I.R.	Ri ≥ 1000MΩ 或 Ri * Cr ≥ 25S	<p>※在 40 ± 2°C 和 90—95% 相對濕度條件下放置 500+24/-0 小時。然後將其移動到室溫條件下恢復放置 48 ± 2 小時，進行測量。</p>															
外觀	無缺陷或異常																									
電容量變化率	X7R, X5R: 在 ± 10% 範圍內 Z5U, Y5V: 在 ± 30% 範圍內																									
D.F.	≤ 2倍初始標準																									
I.R.	Ri ≥ 1000MΩ 或 Ri * Cr ≥ 25S																									
16	濕度負荷	<table border="1"> <tr> <td>外觀</td> <td>無缺陷或異常</td> </tr> <tr> <td>電容量變化率</td> <td>X7R, X5R: 在 ± 10% 範圍內 Z5U, Y5V: 在 ± 30% 範圍內</td> </tr> <tr> <td>D.F.</td> <td>≤ 2倍初始標準</td> </tr> <tr> <td>I.R.</td> <td>Ri ≥ 2500MΩ 或 Ri * Cr ≥ 25S</td> </tr> </table>	外觀	無缺陷或異常	電容量變化率	X7R, X5R: 在 ± 10% 範圍內 Z5U, Y5V: 在 ± 30% 範圍內	D.F.	≤ 2倍初始標準	I.R.	Ri ≥ 2500MΩ 或 Ri * Cr ≥ 25S	<p>※在 40 ± 2°C 和 90—95% 相對濕度條件下施加額定電壓 500+24/-0 小時。然後將其移動到室溫條件下放置 48 ± 2 小時，進行測量。</p>															
外觀	無缺陷或異常																									
電容量變化率	X7R, X5R: 在 ± 10% 範圍內 Z5U, Y5V: 在 ± 30% 範圍內																									
D.F.	≤ 2倍初始標準																									
I.R.	Ri ≥ 2500MΩ 或 Ri * Cr ≥ 25S																									
17	壽命	<table border="1"> <tr> <td>外觀</td> <td>無缺陷或異常</td> </tr> <tr> <td>電容量變化率</td> <td>X7R, X5R: 在 ± 20% 範圍內 Z5U, Y5V: 在 ± 30% 範圍內</td> </tr> <tr> <td>D.F.</td> <td>≤ 2倍初始標準</td> </tr> <tr> <td>I.R.</td> <td>Ri ≥ 4000MΩ 或 Ri * Cr ≥ 40S</td> </tr> </table>	外觀	無缺陷或異常	電容量變化率	X7R, X5R: 在 ± 20% 範圍內 Z5U, Y5V: 在 ± 30% 範圍內	D.F.	≤ 2倍初始標準	I.R.	Ri ≥ 4000MΩ 或 Ri * Cr ≥ 40S	<p>※在上限溫度下施加 1.5 倍的額定工作電壓 1000 ± 12 小時，充放電電流不超過 50mA。將其移動到室溫條件下恢復放置 48 ± 2 小時，進行測量。</p>															
外觀	無缺陷或異常																									
電容量變化率	X7R, X5R: 在 ± 20% 範圍內 Z5U, Y5V: 在 ± 30% 範圍內																									
D.F.	≤ 2倍初始標準																									
I.R.	Ri ≥ 4000MΩ 或 Ri * Cr ≥ 40S																									

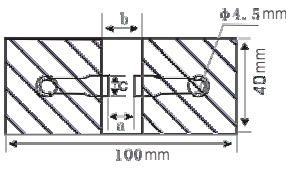
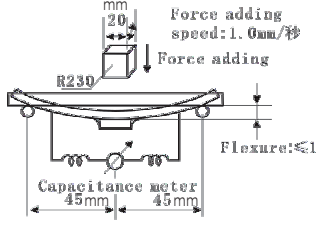
Number	Item	Standard		Test Method																								
13	Bending Resistance	Cap. Change ratio :  within $\pm 10\%$		  <table border="1"> <thead> <tr> <th rowspan="2">L×W (mm)</th> <th colspan="4">Dimension</th> </tr> <tr> <th>a</th> <th>b</th> <th>c</th> <th>d</th> </tr> </thead> <tbody> <tr> <td>4.5×2.0</td> <td>3.5</td> <td>7.0</td> <td>2.4</td> <td></td> </tr> <tr> <td>4.5×3.2</td> <td>3.5</td> <td>7.0</td> <td>3.7</td> <td>1.0</td> </tr> <tr> <td>5.7×6.3</td> <td>4.5</td> <td>8.0</td> <td>5.6</td> <td></td> </tr> </tbody> </table>	L×W (mm)	Dimension				a	b	c	d	4.5×2.0	3.5	7.0	2.4		4.5×3.2	3.5	7.0	3.7	1.0	5.7×6.3	4.5	8.0	5.6	
L×W (mm)	Dimension																											
	a	b	c	d																								
4.5×2.0	3.5	7.0	2.4																									
4.5×3.2	3.5	7.0	3.7	1.0																								
5.7×6.3	4.5	8.0	5.6																									
14	Temperature Cycle	Appearance	No defects	<table border="1"> <thead> <tr> <th>Stage</th> <th>Temperature (°C)</th> <th>Time (min.)</th> </tr> </thead> <tbody> <tr> <td>1</td> <td>Min. Operating Temperature <math>\pm 3</math></td> <td>30 <math>\pm</math> 3</td> </tr> <tr> <td>2</td> <td>Room Temperature</td> <td>2—3</td> </tr> <tr> <td>3</td> <td>Max. Operating Temperature 2</td> <td>30 <math>\pm</math> 3</td> </tr> <tr> <td>4</td> <td>Room Temperature</td> <td>2—3</td> </tr> </tbody> </table>	Stage	Temperature (°C)	Time (min.)	1	Min. Operating Temperature $\pm 3$	30 $\pm$ 3	2	Room Temperature	2—3	3	Max. Operating Temperature 2	30 $\pm$ 3	4	Room Temperature	2—3									
Stage	Temperature (°C)	Time (min.)																										
1	Min. Operating Temperature $\pm 3$	30 $\pm$ 3																										
2	Room Temperature	2—3																										
3	Max. Operating Temperature 2	30 $\pm$ 3																										
4	Room Temperature	2—3																										
	Cap. Change ratio	X7R, X5R: within $\pm 10\%$ Z5U, Y5V: within $\pm 20\%$																										
	D.F.	Same as original standard																										
	I.R.	same as original standard																										
15	Humidity Steady State	Appearance	No defects	※Set the capacitor for 500+24/-0 hours at the condition of $40 \pm 2^\circ\text{C}$ and 90-95% humidity. Then remove and set it for $48 \pm 2$ hours at room temperature, then measure.																								
	Cap. Change ratio	X7R, X5R: within $\pm 10\%$ Z5U, Y5V: within $\pm 30\%$																										
	D.F.	Not more than twice of initial value																										
	I.R.	$R_i \geq 1000M \Omega$ or $R_i \cdot C_R \geq 25S$																										
16	Humidity Load	Appearance	No defects	※Apply rated voltage to the capacitor for 500+24/-0 hours at the condition of $40 \pm 2^\circ\text{C}$ and 90-95% humidity. Remove and set it for $48 \pm 2$ hours at room temperature, then measure.																								
	Cap. Change ratio	X7R, X5R: within $\pm 10\%$ Z5U, Y5V: within $\pm 30\%$																										
	D.F.	Not more than twice of initial value																										
	I.R.	$R_i \geq 2500M \Omega$ or $R_i \cdot C_R \geq 25S$																										
17	Life Test	Appearance	No defects	※Apply 1.5 times rated voltage to the capacitor for $1000 \pm 12$ hours at the upper temperature limits, the charging current should be less than 50mA. Remove and set it for 24 2 hours at room temperature, then measure.																								
	Cap. Change ratio	X7R, X5R: within $\pm 20\%$ Z5U, Y5V: within $\pm 30\%$																										
	D.F.	Not more than twice of initial value																										
	I.R.	$R_i \geq 4000M \Omega$ or $R_i \cdot C_R \geq 40S$																										

■ 通用型片容特性曲綫

- COG和PH、RH、SH、TH、UH系列

溫度係數圖

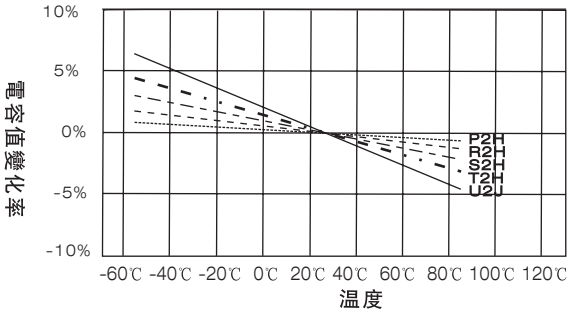

X7R溫度特性

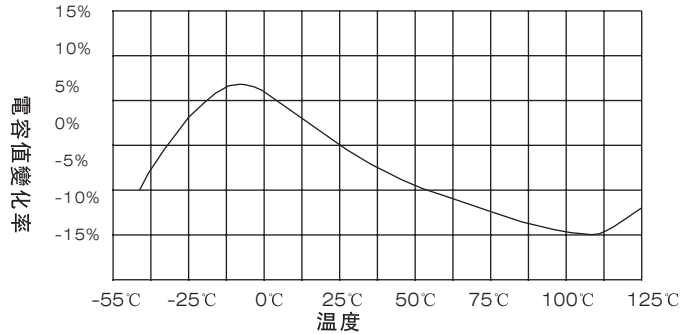

Z5U溫度特性

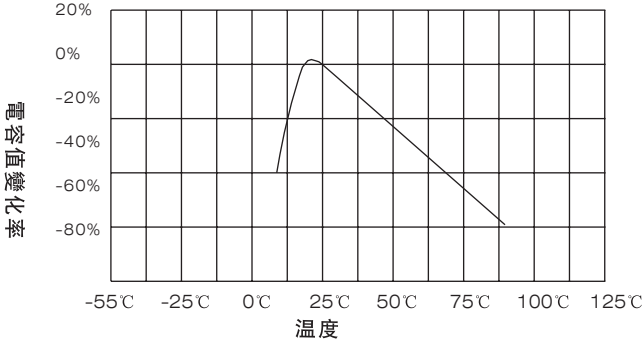

Y5V溫度特性

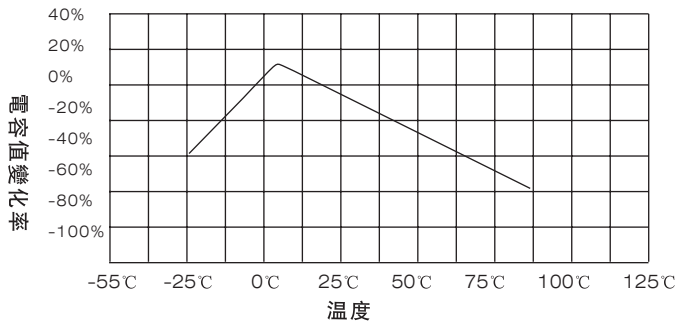

- 電容器偏壓特性圖

測量條件: COG :1MHZ  
X7R,Z5U,Y5V:1KHZ

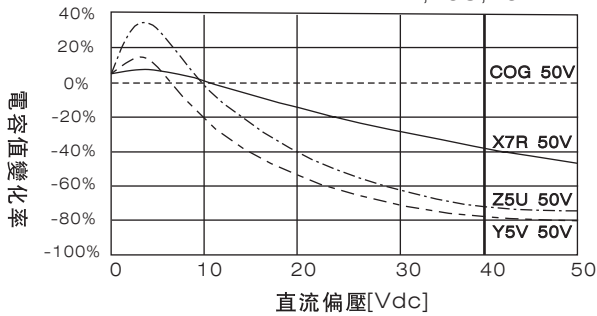

- 電容器交流電壓特性圖

測量條件: COG :1MHZ  
X7R,Z5U,Y5V:1KHZ

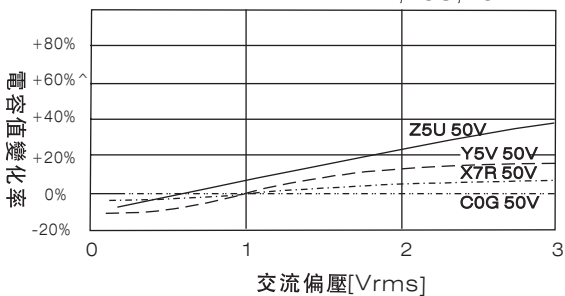

- 電容器老化特性圖

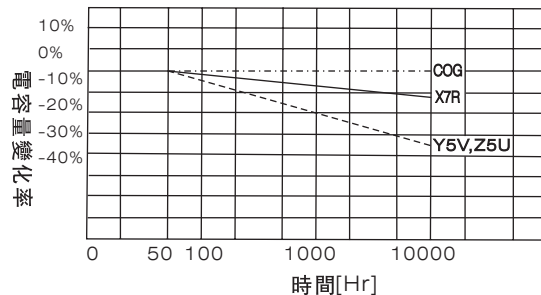

## ■ GENEREL-USE MLCC CHARCCTER PROFILES

- COG and PH、RH、SH、TH、UH saries temperature coefficient

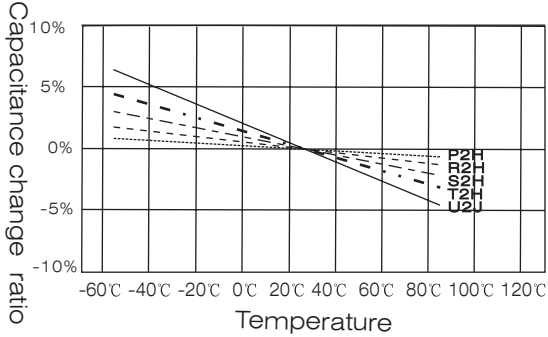

X7R temprture characteristics

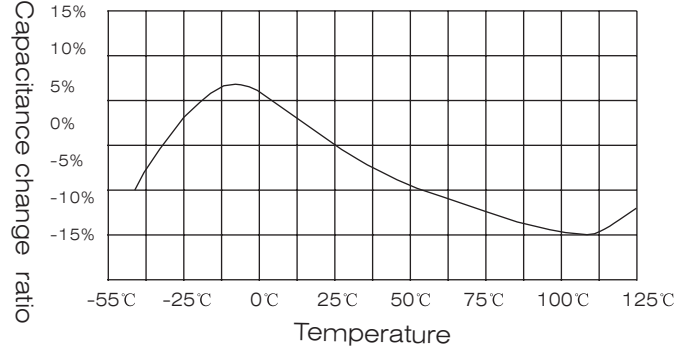

Z5U temperature character

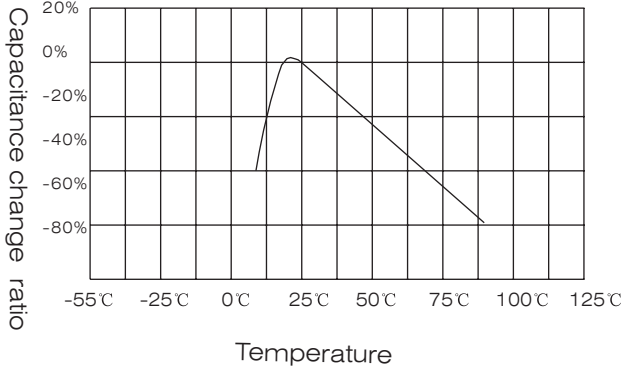

Y5V temperature characteristics

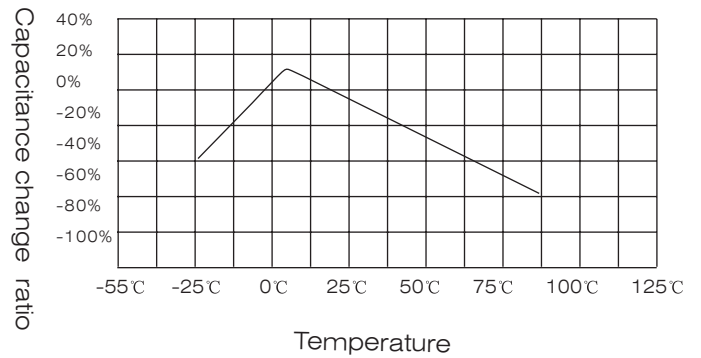

- DC Voltage Characteristics

Measuring condition COG :1MHz  
X7R、Z5U、Y5V:1KHz

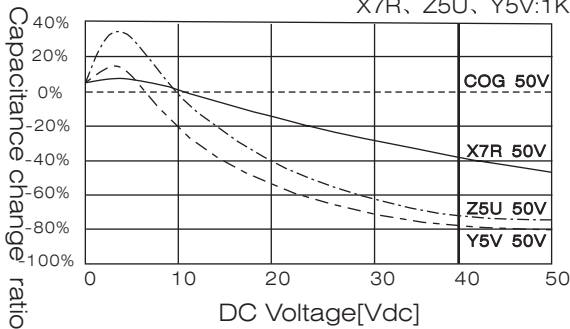

- Capacitance-AC Voltage

Characterics Measuring condition: COG :1MHz  
X7R,Z5U,Y5V:1KHz

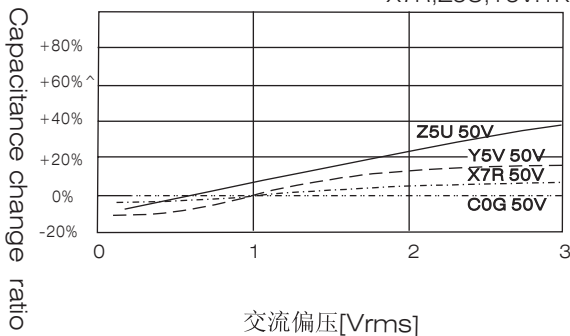

- Capacitance change\_aging

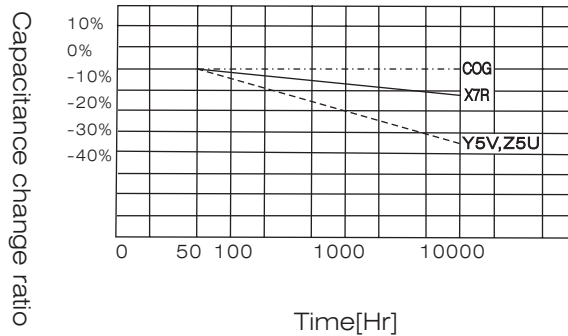

### ■ 通用高Q型片容

通用高Q型片容屬於 I 類高頻電容器。

#### ● 特性

- \* 高頻率，高Q值，使用頻率在1MHZ ~ 3GHZ之間。
- \* 疊層獨石結構，具有高可靠性。
- \* 優良的焊接性和耐焊性，適用於回流焊和波峰焊。

#### ● 應用

- \* 適用於射頻RF電路及要求Hi-Q，低ESR，高頻率響應的微波電路中。

#### ● 產品規格型號表示方法

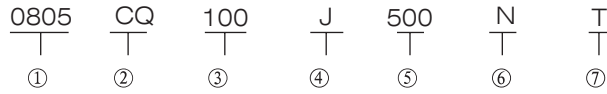

① 尺寸		
型號	英制(英寸)	公制(毫米)
0402	0.04 × 0.02	1.00 × 0.50
0603	0.06 × 0.03	1.60 × 0.80
0805	0.08 × 0.05	2.00 × 1.25

② 介質種類
代碼
CQ

③ 標稱電容量(PF)	
表示方式	實際值
100	10 × 10 <sup>0</sup>
101	10 × 10 <sup>1</sup>
102	10 × 10 <sup>2</sup>

④ 誤差級別	
代碼	誤差
J	± 5.00%
G	± 2.00%
C	± 0.25PF
B	± 0.10PF
D	± 0.50PF

⑤ 工作電壓	
表示方法	額定電壓
250	25V
500	50V
101	100V
201	200V

⑥ 端頭類別	
表示方法	端頭材料
S	純銀端頭
C	純銅端頭
N	三層電鍍端頭 (銀或銅層/鎳層/錫層)

⑦ 包裝方式	
表示方法	包裝
無標記	袋裝散包裝
T	編帶包裝
B	塑料盒散包裝

#### ● 外形尺寸

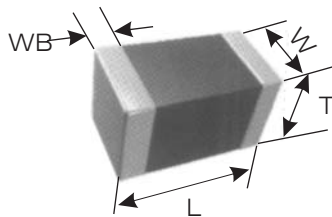

規格型號		尺寸( mm )			
英制表示	公制表示	L	W	T	WB
0402	1005	1.00 ± 0.05	0.50 ± 0.05	0.50 ± 0.05	0.25 ± 0.10
0603	1608	1.60 ± 0.10	0.80 ± 0.10	0.80 ± 0.10	0.30 ± 0.10
0805	2012	2.00 ± 0.20	1.25 ± 0.20	0.80 ± 0.20 1.00 ± 0.20 1.25 ± 0.20	0.50 ± 0.20

## High-Q MLCC for General-use

High-Q MLCC for General-use is class I high frequency capacitor.

### Features:

- \* It has High frequency and high Q value, its using frequency is 1MHz~3GHz.
- \* It has multi-layer monolithic structure, has high reliability.
- \* It has good solderability and soldering resistance, suitable for flow soldering/reflow soldering.

### Applications:

- \* It is suitable for ultra-high frequency RF circuits and Hi-Q, low ESR, high frequency response microwave circuits.

### Product Part Number Expression:

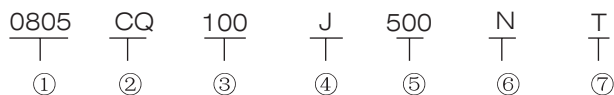

①Dimensions		
Type	British (Inch)	Metric (mm)
0402	0.04×0.02	1.00×0.50
0603	0.06×0.03	1.60×0.80
0805	0.08×0.05	2.00×1.25

②Dielectric Type
Code
CQ

③Normal Capacitance(PF)	
Expression Method	Actual Value
100	$10 \times 10^0$
101	$10 \times 10^1$
102	$10 \times 10^2$

④Capacitance Tolerance	
Code	Tolerance
J	± 5.00%
G	± 2.00%
C	± 0.25PF
B	± 0.10PF
D	± 0.50PF

⑤Rated Voltage	
Expression Method	Actual Value
250	25V
500	50V
101	100V
201	200V

⑥Termination Type	
Expression Method	Termination Material
S	Pure Silver
C	Pure Copper
N	Three Layers Plating Terminal (Silver or Copper layer/ Nickel layer /Tin layer)

⑦Package Method	
Expression Method	Packaging
No Mark	Bulk Packaging in a Bag
T	Taping Packaging
B	Bulk Plastic Box Packaging

### Outside Dimension

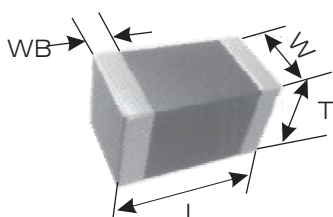

Type		Dimension (mm)			
British expression	Metric expression	L	W	T	WB
0402	1005	$1.00 \pm 0.05$	$0.50 \pm 0.05$	$0.50 \pm 0.05$	$0.25 \pm 0.10$
0603	1608	$1.60 \pm 0.10$	$0.80 \pm 0.10$	$0.80 \pm 0.10$	$0.30 \pm 0.10$
0805	2012	$2.00 \pm 0.20$	$1.25 \pm 0.20$	$0.80 \pm 0.20$ $1.00 \pm 0.20$ $1.25 \pm 0.20$	$0.50 \pm 0.20$



# 多層片式陶瓷電容器

## MULTILAYER CHIP CERAMIC CAPACITOR

- 電容量範圍

項目	通用高Q型片容									
介質種類	CQ									
尺寸	0402		0603				0805			
工作電壓	25V	50V	25V	50V	100V	200V 250V	25V	50V	100V	200V 250V
電容量										
0.5PF										
1PF										
2PF										
3PF										
4PF										
50PF										
6PF										
7PF										
8PF										
10PF										
15PF										
18PF										
22PF										
33PF										
39PF										
47PF										
56PF										
68PF										
82PF										
100PF										
120PF										
150PF										
180PF										
220PF										
330PF										
390PF										
470PF										
560PF										
680PF										
820PF										
1000PF										
1200PF										
1500PF										

• Capacitance Range

Item	High-Q MLCC for General-use									
Dielectric Type	CQ									
Dimension	0402		0603				0805			
Rated Volatage	25V	50V	25V	50V	100V	200V 250V	25V	50V	100V	200V 250V
Capacitance										
0.5PF										
1PF										
2PF										
3PF										
4PF										
50PF										
6PF										
7PF										
8PF										
10PF										
15PF										
18PF										
22PF										
33PF										
39PF										
47PF										
56PF										
68PF										
82PF										
100PF										
120PF										
150PF										
180PF										
220PF										
330PF										
390PF										
470PF										
560PF										
680PF										
820PF										
1000PF										
1200PF										
1500PF										

# 多層片式陶瓷電容器

## MULTILAYER CHIP CERAMIC CAPACITOR

### 微波片容

#### ● 特點:

高Q值、低等效串聯電阻、高自諧振頻率

#### ● 應用:

- \* 移動通信基站
- \* 無線通信產品
- \* 射頻功率放大器
- \* 產品規格型號表示方法

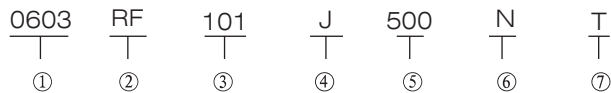

① 尺寸		
型號	英制(英寸)	公制(毫米)
0402	0.04 × 0.02	1.00 × 0.50
0603	0.06 × 0.03	1.60 × 0.80
0805	0.08 × 0.05	2.00 × 1.25

② 介質種類	
代碼	
RF	

③ 標稱電容量(PF)	
表示方式	實際值
100	10 × 10 <sup>0</sup>
101	10 × 10 <sup>1</sup>
102	10 × 10 <sup>2</sup>

④ 誤差級別	
代碼	誤差
J	± 5%
K	± 10%

⑤ 工作電壓	
表示方法	額定電壓
6R3	6.3V
500	50V
101	100V

⑥ 端頭類別	
表示方法	端頭材料
S	純銀端頭
C	純銅端頭
N	三層電鍍端頭 (銀或銅層/鎳層/錫層)

⑦ 包裝方式	
表示方法	包裝
無標記	袋裝散包裝
T	編帶包裝
B	塑料盒散包裝

#### ● 外形尺寸

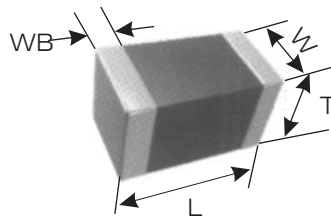

規格型號		尺寸 (mm)			
英制表示	公制表示	L	W	T	WB
0402	1005	1.00 ± 0.05	0.50 ± 0.05	0.50 ± 0.05	0.25 ± 0.10
0603	1608	1.60 ± 0.10	0.80 ± 0.10	0.80 ± 0.10	0.30 ± 0.10
0805	2012	2.00 ± 0.20	1.25 ± 0.20	0.80 ± 0.20 1.00 ± 0.20 1.25 ± 0.20	0.50 ± 0.20
0505	1414	1.40 ± 0.38	1.40 ± 0.38	≤ 1.45	0.30 ± 0.10
1111	2828	2.79 ± 0.50	2.79 ± 0.50	≤ 2.59	0.80 ± 0.30

## ■ Microwave Caps (RF SERIES)

### ● Features

- \*High Q
- \*Low equivalent series resistance
- \*High self-resonance

### ● Applications

- \*Cellular base station
- \*Wireless communication devices
- \*RF power amplifier

### ● HOW TO ORDER

0603
RF
101
J
500
N
T  
①
②
③
④
⑤
⑥
⑦

①Dimensions		
Type	British (Inch)	Metric (mm)
0402	0.04×0.02	1.00×0.50
0603	0.06×0.03	1.60×0.80
0805	0.08×0.05	2.00×1.25

②Dielectric Type
Code
RF

③Normal Capacitance(PF)	
Expression Method	Actual Value
100	$10 \times 10^0$
101	$10 \times 10^1$
102	$10 \times 10^2$

④Capacitance Tolerance	
Code	Tolerance
J	±5%
K	±10%

⑤Rated Voltage	
Expression Method	Actual Value
6R3	6.3V
500	50V
101	100V

⑥Termination Type	
Expression Method	Termination Material
S	Pure Silver
C	Pure Copper
N	Three Layers Plating Terminal (Silver or Copper layer/ Nickel layer /Tin layer)

⑦Package Method	
Expression Method	Packaging
No Mark	Bulk Packaging in a Bag
T	Taping Packaging
B	Bulk Plastic Box Packaging

### • Outside Dimension

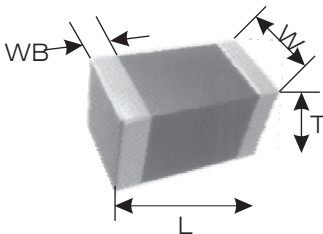

Type		Dimension (mm)			
British expression	Metric expression	L	W	T	WB
0402	1005	$1.00 \pm 0.05$	$0.50 \pm 0.05$	$0.50 \pm 0.05$	$0.25 \pm 0.10$
0603	1608	$1.60 \pm 0.10$	$0.80 \pm 0.10$	$0.80 \pm 0.10$	$0.30 \pm 0.10$
0805	2012	$2.00 \pm 0.20$	$1.25 \pm 0.20$	$0.80 \pm 0.20$ $1.00 \pm 0.20$ $1.25 \pm 0.20$	$0.50 \pm 0.20$
0505	1414	$1.40 \pm 0.38$	$1.40 \pm 0.38$	$\leq 1.45$	$0.30 \pm 0.10$
1111	2828	$2.79 \pm 0.50$	$2.79 \pm 0.50$	$\leq 2.59$	$0.80 \pm 0.30$

# 多層片式陶瓷電容器

## MULTILAYER CHIP CERAMIC CAPACITOR

- 電容量範圍

項目	微波片容															
介質種類	RF															
尺寸	0402			0603			0805			0505			1111			
工作電壓	25V	50V	100V	25V 50V	100V	200V 250V	25V 50V	100V	200V 250V	25V 50V	100V	200V 250V	25V 50V	100V	200V 250V	500V
電容量																
0.1PF																
0.3PF																
0.5PF																
1PF																
3PF																
5PF																
6PF																
7PF																
8PF																
10PF																
15PF																
18PF																
22PF																
33PF																
39PF																
47PF																
56PF																
68PF																
82PF																
100PF																
120PF																
150PF																
180PF																
220PF																
330PF																
390PF																
470PF																
560PF																
680PF																
820PF																
1000PF																
1200PF																
1500PF																

• Capacitance Range

Item	Microwave Caps															
Dielectric Type	RF															
Dimension	0402			0603			0805			0505			1111			
Rated Volatage	25V	50V	100V	25V 50V	100V	200V 250V	25V 50V	100V	200V 250V	25V 50V	100V	200V 250V	25V 50V	100V	200V 250V	500V
Capacitance																
0.1PF																
0.3PF																
0.5PF																
1PF																
3PF																
5PF																
6PF																
7PF																
8PF																
10PF																
15PF																
18PF																
22PF																
33PF																
39PF																
47PF																
56PF																
68PF																
82PF																
100PF																
120PF																
150PF																
180PF																
220PF																
330PF																
390PF																
470PF																
560PF																
680PF																
820PF																
1000PF																
1200PF																
1500PF																

## 多層片式陶瓷電容器

## MULTILAYER CHIP CERAMIC CAPACITOR

### ■ 直流中高壓片容

中高壓多層片狀陶瓷電容器是在多層片狀陶瓷電容器的工藝技術、設備基礎上，通過採用特殊設計制作出來的一種具有良好耐壓，高可靠性的產品。該產品適合于表面貼裝，適合于多種直流高壓綫路，可以有效地改善電子綫路的性能。

#### ● 特性

- \* 疊層獨石結構。
- \* 體積小，電容量高，能在高電壓下工作。
- \* 具有良好的可焊性和耐焊性。
- \* 技術指標(下表):

額定電壓	測試電壓	最大充電電流	測試時間
≤ 1000V	1.5倍額定電壓	50mA	5S
1000V ~ 2000V	1.2倍額定電壓	50mA	5S
≥ 2000V	1.2倍額定電壓	10mA	5S

#### ● 應用

- \* 用作DC-DC轉換器的熱-冷耦合。
- \* 用于電話、傳真機及制解調器的綫路濾波器及振鈴檢測器。
- \* 用于切換式電源的二極管緩衝電路上。

#### ● 產品規格型號表示方法

1206	CG	100	J	202	N	T
①	②	③	④	⑤	⑥	⑦

① 尺寸		
型號	英制(英寸)	公制(毫米)
0603	0.60 × 0.30	1.60 × 0.80
0805	0.08 × 0.05	2.00 × 1.25
1206	0.12 × 0.06	3.20 × 1.60
1210	0.12 × 0.10	3.20 × 2.50
1808	0.18 × 0.08	4.50 × 2.00
1812	0.18 × 0.12	4.50 × 3.20
2225	0.22 × 0.25	5.70 × 6.30

② 介質種類	
代碼	介質材料
CG	COG或NPO
B	X7R
F	Y5V

③ 標稱電容量(PF)	
表示方式	實際值
100	10 × 10 <sup>0</sup>
101	10 × 10 <sup>1</sup>
102	10 × 10 <sup>2</sup>

④ 誤差級別	
代碼	誤差
J	± 5%
K	± 10%

⑤ 工作電壓	
表示方法	額定電壓
6R3	6.3V
500	50V
101	100V

⑥ 端頭類別	
表示方法	端頭材料
S	純銀端頭
C	純銅端頭
N	三層電鍍端頭 (銀或銅層/鎳層/錫層)

⑦ 包裝方式	
表示方法	包裝
無標記	袋裝散包裝
T	編帶包裝
B	塑料盒散包裝

## ■ DC Medium-voltage MLCC

DC medium-voltage MLCC has good high-voltage reliability, it is made in special design that based on the MLCC technology and equipments. It is suitable for surface-mounting , can improve the properties of circuits.

### ● Features

- \* New monolithic structure
- \* The size of the capacitor is small, yet has high electrostatic capacitance, can operate at high-voltage levels.
- \* Has good solderability.
- \* Technology Parameter (refer to the picture below):

Rated Voltage	Measuring Condition	Max. charging current	Measuring Time
≤1000V	1. 5×Ur.	50mA	5S
1000V~2000V	1. 2×Ur.	50mA	5S
≥2000V	1. 2×Ur.	10mA	5S

### ● Applications:

- \* DC-DC converter.
- \* The circuit filter and vibration bell of telephone, electrograph and modem.
- \* Snubber circuit for switching power supply.

### ● Product Part Number Expression:

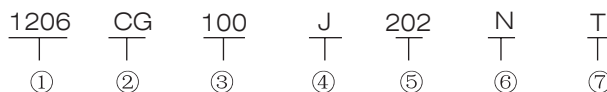

①Dimensions		
Type	British (Inch)	Metric (mm)
0603	0.60×0.30	1.6×0.8
0805	0.08×0.05	2.0×1.25
1206	0.12×0.06	3.2×1.6
1210	0.12×0.10	3.2×2.5
1808	0.18×0.08	4.5×2.0
1812	0.18×0.12	4.5×3.2
2225	0.22×0.25	5.7×6.3

②Dielectric Type	
Code	Dielectric Material
CG	COG or NPO
B	X7R
F	Y5V

③Normal Capacitance(PF)	
Expression Method	Actual Value
100	$10 \times 10^0$
101	$10 \times 10^1$
102	$10 \times 10^2$

④Capacitance Tolerance	
Code	Tolerance
J	± 5%
K	± 10%

⑤Rated Voltage	
Expression Method	Actual Value
6R3	6.3V
500	50V
101	100V

⑥Termination Type	
Expression Method	Termination Material
S	Pure Silver
C	Pure Copper
N	Three Layers Plating Terminal (Silver or Copper layer/ Nickel layer /Tin layer)

⑦Package Method	
Expression Method	Packaging
NOMARKS	Bulk Packaging in a Bag
T	Taping Packaging
B	Bulk Plastic Box Packaging



## 多層片式陶瓷電容器

## MULTILAYER CHIP CERAMIC CAPACITOR

### • 外形尺寸

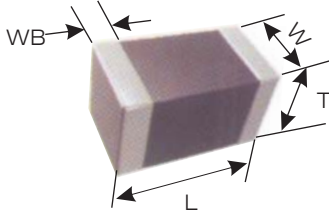

規格型號		尺寸( mm)			
英制表示	公制表示	L	W	T	WB
0603	1608	1.60 ± 0.10	0.80 ± 0.10	0.80 ± 0.10	0.30 ± 0.10
0805	2012	2.00 ± 0.20	1.25 ± 0.20	0.80 ± 0.20 1.00 ± 0.20 1.25 ± 0.20	0.50 ± 0.20
1206	3216	3.20 ± 0.30	1.60 ± 0.30	0.80 ± 0.20 1.00 ± 0.20 1.25 ± 0.20	0.60 ± 0.30
1210	3225	3.20 ± 0.30	2.50 ± 0.30	≤ 2.8	0.60 ± 0.30
1808	4520	4.50 ± 0.40	2.00 ± 0.20	≤ 2.2	0.60 ± 0.30
1812	4532	4.50 ± 0.40	3.20 ± 0.30	≤ 3.5	0.60 ± 0.30
2225	5763	5.70 ± 0.50	6.30 ± 0.50	≤ 6.2	0.60 ± 0.30

### • 電容量範圍

尺寸規格	工作電壓(V)	電容量範圍(PF)			尺寸規格	工作電壓(V)	電容量範圍(PF)		
		NPO	X7R	Y5V			NPO	X7R	Y5V
0603	100	0.5 ~ 1000	150 ~ 100,000	2,200 ~ 100,000	1808	2000	10 ~ 470	150 ~ 10,000	-----
	200	0.5 ~ 1000	150 ~ 10,000	-----		3000	10 ~ 330	150 ~ 4,700	-----
0805	100	0.5 ~ 4,700	150 ~ 100,000	10,000 ~ 100,000	1812	4000	10 ~ 33	150 ~ 2,200	-----
	200	0.5 ~ 4,700	150 ~ 22,000	10,000 ~ 47,000		5000	10 ~ 33		
	250	0.5 ~ 1,500	150 ~ 22,000	10,000 ~ 47,000		100	10 ~ 10,000	150 ~ 1,000,000	150,000 ~ 2,200,000
1206	500	0.5 ~ 560	150 ~ 10,000	-----	200	10 ~ 6,800	150 ~ 560,000	100,000 ~ 470,000	
	100	0.5 ~ 3,300	150 ~ 470,000	10,000 ~ 470,000	250	10 ~ 6,800	150 ~ 560,000	100,000 ~ 470,000	
	200	0.5 ~ 2,700	150 ~ 220,000	10,000 ~ 220,000	500	10 ~ 4,700	150 ~ 150,000	-----	
	250	0.5 ~ 2,700	150 ~ 220,000	10,000 ~ 220,000	1000	10 ~ 1,200	150 ~ 56,000	-----	
	500	0.5 ~ 1,500	150 ~ 33,000	-----	2000	10 ~ 1,000	150 ~ 12,000	-----	
	1000	0.5 ~ 1,000	150 ~ 10,000	-----	3000	10 ~ 560	150 ~ 4,700	-----	
1210	2000	0.5 ~ 270	150 ~ 2,700	-----	4000	10 ~ 220	150 ~ 3,300	-----	
	100	10 ~ 6,800	150 ~ 1,000,000	15,000 ~ 1,000,000	5000	10 ~ 68			
	200	10 ~ 3,300	150 ~ 220,000	15,000 ~ 470,000	2225	100	10 ~ 27,000	150 ~ 2,200,000	250,000 ~ 3,300,000
	250	10 ~ 3,300	150 ~ 220,000	15,000 ~ 470,000		200	10 ~ 12,000	150 ~ 1,200,000	220,000 ~ 2,200,000
	500	10 ~ 2,200	150 ~ 68,000	-----		250	10 ~ 12,000	150 ~ 1,200,000	220,000 ~ 2,200,000
	1000	10 ~ 1,000	150 ~ 22,000	-----		500	10 ~ 6,800	150 ~ 470,000	-----
2000	10 ~ 470	150 ~ 10,000	-----	1000		10 ~ 3,900	150 ~ 100,000	-----	
1808	100	10 ~ 4,700	150 ~ 2,200,000	150,000 ~ 1,000,000	2000	10 ~ 1,000	150 ~ 47,000	-----	
	200	10 ~ 3,900	150 ~ 220,000	10,000 ~ 390,000	3000	10 ~ 680	150 ~ 15,000	-----	
	250	10 ~ 3,900	150 ~ 220,000	10,000 ~ 390,000	4000	10 ~ 560	150 ~ 6,800	-----	
	500	10 ~ 2,700	150 ~ 68,000	-----	5000	10 ~ 120	150 ~ 3,300	-----	
	1000	10 ~ 1,000	150 ~ 22,000	-----					

• Outside Dimension

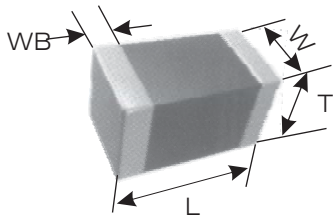

Type		Dimension (mm)			
British expression	Metric expression	L	W	T	WB
0603	1608	1.60±0.10	0.80±0.10	0.80±0.10	0.30±0.10
0805	2012	2.00±0.20	1.25±0.20	0.80±0.20 1.00±0.20 1.25±0.20	0.50±0.20
1206	3216	3.20±0.30	1.60±0.30	0.80±0.20 1.00±0.20 1.25±0.20	0.60±0.30
1210	3225	3.20±0.30	2.50±0.30	≤2.8	0.60±0.30
1808	4520	4.50±0.40	2.00±0.20	≤2.2	0.60±0.30
1812	4532	4.50±0.40	3.20±0.30	≤3.5	0.60±0.30
2225	5763	5.70±0.50	6.30±0.50	≤6.2	0.60±0.30

• Capacitance Range

Size	Rated Voltage	Capacitance Range(pf)			Size	Rated Voltage	Capacitance Range(pf)		
		NPO	X7R	Y5V			NPO	X7R	Y5V
0603	100	0.5 ~ 1000	150 ~ 100,000	2, 200 ~ 100,000	1808	2000	10 ~ 470	150 ~ 10,000	-----
	200	0.5 ~ 1000	150 ~ 10,000	-----		3000	10 ~ 330	150 ~ 4,700	-----
0805	100	0.5 ~ 4,700	150 ~ 100,000	10,000 ~ 100,000		4000	10 ~ 33	150 ~ 2,200	-----
	200	0.5 ~ 4,700	150 ~ 22,000	10,000 ~ 47,000	5000	10 ~ 33			
	250	0.5 ~ 1,500	150 ~ 22,000	10,000 ~ 47,000	1812	100	10 ~ 10,000	150 ~ 1,000,000	150,000 ~ 2,200,000
	500	0.5 ~ 560	150 ~ 10,000	-----		200	10 ~ 6,800	150 ~ 560,000	100,000 ~ 470,000
1206	100	0.5 ~ 3,300	150 ~ 470,000	10,000 ~ 470,000		250	10 ~ 6,800	150 ~ 560,000	100,000 ~ 470,000
	200	0.5 ~ 2,700	150 ~ 220,000	10, 000 ~ 220,000		500	10 ~ 4,700	150 ~ 150,000	-----
	250	0.5 ~ 2,700	150 ~ 220,000	10, 000 ~ 220,000		1000	10 ~ 1,200	150 ~ 56,000	-----
	500	0.5 ~ 1,500	150 ~ 33, 000	-----		2000	10 ~ 1,000	150 ~ 12,000	-----
	1000	0.5 ~ 1,000	150 ~ 10,000	-----		3000	10 ~ 560	150 ~ 4,700	-----
	2000	0.5 ~ 270	150 ~ 2,700	-----		4000	10 ~ 220	150 ~ 3,300	-----
1210	100	10 ~ 6,800	150 ~ 1,000,000	15,000 ~ 1,000,000		5000	10 ~ 68		
	200	10 ~ 3,300	150 ~ 220,000	15,000 ~ 470,000		2225	100	10 ~ 27,000	150 ~ 2,200,000
	250	10 ~ 3,300	150 ~ 220,000	15,000 ~ 470,000	200		10 ~ 12,000	150 ~ 1,200,000	220,000 ~ 2,200,000
	500	10 ~ 2,200	150 ~ 68,000	-----	250		10 ~ 12,000	150 ~ 1,200,000	220,000 ~ 2,200,000
	1000	10 ~ 1,000	150 ~ 22,000	-----	500		10 ~ 6,800	150 ~ 470,000	-----
	2000	10 ~ 470	150 ~ 10,000	-----	1000		10 ~ 3,900	150 ~ 100,000	-----
1808	100	10 ~ 4,700	150 ~ 2,200,000	150,000 ~ 1,000,000	2000		10 ~ 1,000	150 ~ 47,000	-----
	200	10 ~ 3,900	150 ~ 220,000	10,000 ~ 390,000	3000		10 ~ 680	150 ~ 15,000	-----
	250	10 ~ 3,900	150 ~ 220,000	10,000 ~ 390,000	4000		10 ~ 560	150 ~ 6,800	-----
	500	10 ~ 2,700	150 ~ 68,000	-----	5000		10 ~ 120	150 ~ 3,300	-----
	1000	10 ~ 1,000	150 ~ 22,000	-----					

# 多層片式陶瓷電容器

## MULTILAYER CHIP CERAMIC CAPACITOR

項目	COG中高壓片容																	
尺寸	0603		0805				1206						1210					
工作電壓(V)	100	200	100	200	250	500	100	200	250	500	1000	2000	100	200	250	500	1000	2000
電容量																		
0.5PF																		
1PF																		
4PF																		
5PF																		
8PF																		
10PF																		
15PF																		
18PF																		
22PF																		
33PF																		
47PF																		
68PF																		
100PF																		
120PF																		
150PF																		
180PF																		
220PF																		
270PF																		
330PF																		
470PF																		
560PF																		
680PF																		
820PF																		
1000PF																		
1500PF																		
1800pf																		
2200PF																		
2700PF																		
3300PF																		
4700PF																		
5600PF																		
6800PF																		

Item	COG Medium-voltage MLCC																		
	0603		0805				1206						1210						
Rated Volatage(V)	100	200	100	200	250	500	100	200	250	500	1000	2000	100	200	250	500	1000	2000	
Capacitance																			
0.5PF																			
1PF																			
4PF																			
5PF																			
8PF																			
10PF																			
15PF																			
18PF																			
22PF																			
33PF																			
47PF																			
68PF																			
100PF																			
120PF																			
150PF																			
180PF																			
220PF																			
270PF																			
330PF																			
470PF																			
560PF																			
680PF																			
820PF																			
1000PF																			
1500PF																			
1800pf																			
2200PF																			
2700PF																			
3300PF																			
4700PF																			
5600PF																			
6800PF																			

# 多層片式陶瓷電容器

## MULTILAYER CHIP CERAMIC CAPACITOR

項目	COG中高壓片容																									
尺寸	1808								1812								2225									
工作電壓 (V)	100	200/250	500	1000	2000	3000	4000	5000	100	200/250	500	1000	2000	3000	4000	5000	100	200/250	500	1000	2000	3000	4000	5000		
電容量																										
0.5PF																										
1PF																										
4PF																										
5PF																										
8PF																										
10PF																										
15PF																										
18PF																										
22PF																										
33PF																										
47PF																										
68PF																										
100PF																										
120PF																										
150PF																										
180PF																										
220PF																										
270PF																										
330PF																										
470PF																										
560PF																										
680PF																										
820PF																										
1000PF																										
1200PF																										
1800pf																										
2000PF																										
2700PF																										
3300PF																										
3900PF																										
4700PF																										
6800PF																										
8200PF																										
10nF																										
27nF																										

Item	COG Medium-voltage MLCC																									
	1808								1812								2225									
Dimension																										
Rated Volatage(V)	100	200/250	500	1000	2000	3000	4000	5000	100	200/250	500	1000	2000	3000	4000	5000	100	200/250	500	1000	2000	3000	4000	5000		
Capacitance																										
0.5PF																										
1PF																										
4PF																										
5PF																										
8PF																										
10PF																										
15PF																										
18PF																										
22PF																										
33PF																										
47PF																										
68PF																										
100PF																										
120PF																										
150PF																										
180PF																										
220PF																										
270PF																										
330PF																										
470PF																										
560PF																										
680PF																										
820PF																										
1000PF																										
1200PF																										
1800pf																										
2000PF																										
2700PF																										
3300PF																										
3900PF																										
4700PF																										
6800PF																										
8200PF																										
10nF																										
27nF																										

# 多層片式陶瓷電容器

## MULTILAYER CHIP CERAMIC CAPACITOR

項目	X7R中高壓片容																		
	0603		0805				1206						1210						
工作電壓 (V)	100	200	100	200	250	500	100	200	250	500	1000	2000	100	200	250	500	1000	2000	
電容量																			
100PF																			
150PF																			
330PF																			
470PF																			
680PF																			
1000PF																			
1.5nF																			
2.2nF																			
3.3nF																			
4.7nF																			
6.8nF																			
10nF																			
12nF																			
15nF																			
22nF																			
27nF																			
33nF																			
39nF																			
47nF																			
56nF																			
68nF																			
100nF																			
120nF																			
150nF																			
220nF																			
270nF																			
330nF																			
470nF																			
680nF																			
1 μF																			
2.2 μF																			
4.7 μF																			
10 μF																			
22 μF																			

Item	X7R Medium-voltage MLCC																	
	0603		0805				1206						1210					
Rated Volatage(V)	100	200	100	200	250	500	100	200	250	500	1000	2000	100	200	250	500	1000	2000
Capacitance																		
100PF																		
150PF	■	■	■	■	■	■	■	■	■	■	■	■	■	■	■	■	■	■
330PF	■	■	■	■	■	■	■	■	■	■	■	■	■	■	■	■	■	■
470PF	■	■	■	■	■	■	■	■	■	■	■	■	■	■	■	■	■	■
680PF	■	■	■	■	■	■	■	■	■	■	■	■	■	■	■	■	■	■
1000PF	■	■	■	■	■	■	■	■	■	■	■	■	■	■	■	■	■	■
1.5nF	■	■	■	■	■	■	■	■	■	■	■	■	■	■	■	■	■	■
2.2nF	■	■	■	■	■	■	■	■	■	■	■	■	■	■	■	■	■	■
3.3nF	■	■	■	■	■	■	■	■	■	■	■	■	■	■	■	■	■	■
4.7nF	■	■	■	■	■	■	■	■	■	■	■	■	■	■	■	■	■	■
6.8nF	■	■	■	■	■	■	■	■	■	■	■	■	■	■	■	■	■	■
10nF	■	■	■	■	■	■	■	■	■	■	■	■	■	■	■	■	■	■
12nF	■	■	■	■	■	■	■	■	■	■	■	■	■	■	■	■	■	■
15nF	■	■	■	■	■	■	■	■	■	■	■	■	■	■	■	■	■	■
22nF	■	■	■	■	■	■	■	■	■	■	■	■	■	■	■	■	■	■
27nF	■	■	■	■	■	■	■	■	■	■	■	■	■	■	■	■	■	■
33nF	■	■	■	■	■	■	■	■	■	■	■	■	■	■	■	■	■	■
39nF	■	■	■	■	■	■	■	■	■	■	■	■	■	■	■	■	■	■
47nF	■	■	■	■	■	■	■	■	■	■	■	■	■	■	■	■	■	■
56nF	■	■	■	■	■	■	■	■	■	■	■	■	■	■	■	■	■	■
68nF	■	■	■	■	■	■	■	■	■	■	■	■	■	■	■	■	■	■
100nF	■	■	■	■	■	■	■	■	■	■	■	■	■	■	■	■	■	■
120nF	■	■	■	■	■	■	■	■	■	■	■	■	■	■	■	■	■	■
150nF	■	■	■	■	■	■	■	■	■	■	■	■	■	■	■	■	■	■
220nF	■	■	■	■	■	■	■	■	■	■	■	■	■	■	■	■	■	■
270nF	■	■	■	■	■	■	■	■	■	■	■	■	■	■	■	■	■	■
330nF	■	■	■	■	■	■	■	■	■	■	■	■	■	■	■	■	■	■
470nF	■	■	■	■	■	■	■	■	■	■	■	■	■	■	■	■	■	■
680nF	■	■	■	■	■	■	■	■	■	■	■	■	■	■	■	■	■	■
1 μF	■	■	■	■	■	■	■	■	■	■	■	■	■	■	■	■	■	■
2.2 μF	■	■	■	■	■	■	■	■	■	■	■	■	■	■	■	■	■	■
4.7 μF	■	■	■	■	■	■	■	■	■	■	■	■	■	■	■	■	■	■
10 μF	■	■	■	■	■	■	■	■	■	■	■	■	■	■	■	■	■	■
22 μF	■	■	■	■	■	■	■	■	■	■	■	■	■	■	■	■	■	■



# 多層片式陶瓷電容器

## MULTILAYER CHIP CERAMIC CAPACITOR

項目	X7R中高壓片容																					
尺寸	1808						1812						2225									
工作電壓 (V)	100	200 /250	500	1000	2000	3000	4000	100	200 /250	500	1000	2000	3000	4000	100	200 /250	500	1000	2000	3000	4000	5000
電容量																						
100PF																						
150PF																						
330PF																						
470PF																						
680PF																						
1000PF																						
1nF																						
2.2nF																						
3.3nF																						
4.7nF																						
6.8nF																						
10nF																						
12nF																						
15nF																						
22nF																						
27nF																						
33nF																						
39nF																						
47nF																						
56nF																						
68nF																						
100nF																						
120nF																						
150nF																						
220nF																						
270nF																						
330nF																						
470nF																						
680nF																						
1 μF																						
2.2 μF																						
3.3 μF																						
10 μF																						
22 μF																						

Item	X7R Medium-voltage MLCC																					
Dimension	1808							1812							2225							
Rated Volatage(V)	100	200/250	500	1000	2000	3000	4000	100	200/250	500	1000	2000	3000	4000	100	200/250	500	1000	2000	3000	4000	5000
Capacitance																						
100PF																						
150PF																						
330PF																						
470PF																						
680PF																						
1000PF																						
1nF																						
2.2nF																						
3.3nF																						
4.7nF																						
6.8nF																						
10nF																						
12nF																						
15nF																						
22nF																						
27nF																						
33nF																						
39nF																						
47nF																						
56nF																						
68nF																						
100nF																						
120nF																						
150nF																						
220nF																						
270nF																						
330nF																						
470nF																						
680nF																						
1 μ F																						
2.2 μ F																						
3.3 μ F																						
10 μ F																						
22 μ F																						

# 多層片式陶瓷電容器

## MULTILAYER CHIP CERAMIC CAPACITOR

項目	Y5V中高壓片容																	
尺寸	0603			0805			1206			1210			1812			2225		
工作電壓 (V)	100	100	200	250	100	200	250	100	200	250	100	200	250	100	200	250		
電容量																		
1000PF																		
1.5nF																		
2.2nF	■																	
3.3nF																		
4.7nF																		
6.8nF																		
10nF	■	■	■	■	■	■	■											
12nF																		
15nF								■	■	■								
22nF																		
27nF																		
33nF																		
39nF																		
47nF			■	■														
56nF																		
68nF																		
100nF	■	■																
150nF																		
220nF							■	■	■									
270nF																		
330nF																		
390nF																		
470nF							■	■	■									
680nF																		
820nF																		
1 μF								■										
2.2 μF																		
3.3 μF																		
10 μF																		

Item	Y5V Medium-voltage MLCC																	
Dimension	0603			0805			1206			1210			1812			2225		
Rated Volatage(V)	100	100	200	250	100	200	250	100	200	250	100	200	250	100	200	250		
Capacitance																		
1000PF																		
1.5nF																		
2.2nF	■																	
3.3nF																		
4.7nF																		
6.8nF																		
10nF	■	■	■	■	■	■	■											
12nF																		
15nF								■	■	■								
22nF																		
27nF																		
33nF																		
39nF																		
47nF			■	■														
56nF																		
68nF																		
100nF	■	■																
150nF																		
220nF							■	■										
270nF																		
330nF																		
390nF																		
470nF						■												
680nF																		
820nF																		
1 μF									■									
2.2 μF																		
3.3 μF																		
10 μF																		

■ 直流中高壓COG片容可靠性測試方法

編號	項目	標準	測試方法										
1	工作溫度範圍	-55℃ ~ 125℃											
2	外觀	1. 瓷體顏色一致性好。 2. 芯片無可見損傷,光滑平整。 3. 瓷體無外露電極,裂痕,孔洞。 4. 端電極無裂痕,孔洞,磨損及表面氧化等。 5. 端電極應無延伸現象或延伸部分不超過端頭寬度的一半。	※在 ≥ 10 × 倍以上的顯微鏡下觀察。										
3	尺寸	在規定尺寸範圍內	※使用千分尺或游標卡尺。										
4	電容量	在規定偏差範圍內	※測試儀器:HP4278A電橋、HP4284電橋。 ※測試條件: 1.測試溫度: 25℃ ± 5℃, 濕度:30% ~ 75%。 2.測試電壓: 1.0 ± 0.2V。 3.測試頻率: C < 1000PF, 1.0 ± 0.1MHz; C ≥ 1000PF, 1.0 ± 0.1KHZ										
5	損耗因數(D.F.)	Cr < 5PF < 0.56% 5PF < Cr < 50PF 1.5[(150/Cr)+7] × 10 <sup>-4</sup> Cr > 50PF < 0.15%											
6	絕緣電阻 (I.R.)	C < 10nF, IR ≥ 5 × 10 <sup>10</sup> Ω C > 10nF, IR × CR ≥ 500S	※測試儀器:絕緣電阻測試儀(如:SF2511絕緣測試機)。 ※測試方法:施加額定工作電壓,若額定工作電壓 > 500V,按500V測試,在60 ± 5 秒內測量絕緣電阻。										
7	耐電壓強度	要求	額定電壓	最大充電電流	測試時間								
		耐電壓值 > 2倍額定電壓	100V ≤ Ur < 500V	50mA	5S								
		耐電壓值 > 1.5倍額定電壓	500V ≤ Ur ≤ 1000V	50mA	5S								
		耐電壓值 > 1.2倍額定電壓	1000V < Ur ≤ 2000V	50mA	5S								
耐電壓值 > 1.2倍額定電壓	> 2000V	10mA	5S										
8	電容量溫度特性	在工作溫度範圍內符合電容器特性溫度系數要求	※首先進行預處理:進行 150+0/-10℃熱處理 60 ± 5 分鐘,然后在室溫條件下放置 24 ± 2 小時。 ※在 -55 ~ 125℃範圍內測試電容量,其電容值相對於20℃時數值的變化率應在規定範圍內。										
9	可焊性	75% 端電極覆蓋錫	※將電容器浸在乙醇和松香溶液中。然後浸入有鉛235 ± 5℃ (無鉛245 ± 5℃) 的混合焊錫溶液 2 ± 0.5 秒。浸入速度: 25 ± 2.5mm/秒。										
10	耐焊接熱	外觀	無明顯缺陷	※首先進行預處理:進行 150+0/-10℃熱處理 60 ± 5 分鐘,然后在室溫條件下放置 24 ± 2 小時。 ※然後按下表預熱電容器。將電容器浸入 265 ± 5℃ 的混合焊錫溶液10 ± 1 秒。再在室溫條件下放置24 ± 2 小時,然後進行測量。 浸入速度: 25 ± 2.5mm/秒。 ※預熱條件如下:									
		電容量變化率	≤ ± 5%或 ± 0.5PF,取兩者中最大的。										
		D.F.	同初始標準										
		I.R.	同初始標準										
		<table border="1"> <thead> <tr> <th>階段</th> <th>溫度</th> <th>時間</th> </tr> </thead> <tbody> <tr> <td>1</td> <td>100℃—120℃</td> <td>1分鐘</td> </tr> <tr> <td>2</td> <td>170℃—200℃</td> <td>1分鐘</td> </tr> </tbody> </table>			階段	溫度	時間	1	100℃—120℃	1分鐘	2	170℃—200℃	1分鐘
階段	溫度	時間											
1	100℃—120℃	1分鐘											
2	170℃—200℃	1分鐘											

## ■ Middle and high Voltage COG MLCC reliability test method

Number	Item	Standard	Test Method										
1	Operating Temperature Range	-55°C~125°C											
2	Appearance	1. Good ceramic body color continuity. 2. The chips have no visual damages and must be very smooth. 3. No exposed inner-electrode, no cracks or holes. 4. The outer electrode should have no cracks, holes, damages or surface oxidation. 5. Outer electrode no prolongation or the prolongation is less than half of that of the termination width.	※Check by using microscope $\geq 10\times$ .										
3	Dimensions	Within the specified dimensions	※Using micrometer or vernier calipers										
4	Capacitance	Within the specified tolerance	※Measuring Equipment: HP4278 capacitance meter, HP4284 capacitance,										
5	Dissipation Factor (DF)	Cr < 5PF $\leq 0.56\%$ 5PF $\leq$ Cr < 50PF $1.5[(150/Cr)+7] \times 10^{-4}$ Cr $\geq$ 50PF $\leq 0.15\%$	※Measuring Conditions: 1. Measuring Temperature: 25°C $\pm$ 5°C. Humidity: 30%~75%. 2. Measuring Voltage: 1.0 $\pm$ 0.2V. 3. Measuring Frequency: C < 1000PF, 1.0 $\pm$ 0.1MHz C $\geq$ 1000PF, 1.0 $\pm$ 0.1KHz										
6	Insulation Resistance	C < 10nF, IR $\geq 5 \times 10^{10}\Omega$ C > 10nF, IR $\times$ CR $\geq 500S$	※Measuring Equipment: Insulation resistance meter (such as Sf2511 insulation resistance). ※Measuring Method: Must measure at rated voltage, and if Ur > 500V, then just use 500V, measure the IR within 60 $\pm$ 1 seconds.										
7	Withstanding Voltage	Requirement	Ur	Max. Current	Measuring Time								
		> 2Ur	100V $\leq$ Ur < 500V	50mA	5S								
		> 1.5Ur	500V $\leq$ Ur $\leq$ 1000V	50mA	5S								
		> 1.2Ur	1000V < Ur $\leq$ 2000V	50mA	5S								
	> 1.2Ur	> 2000V	10mA	5S									
8	Capacitance Temperature Characteristics	Must meet the capacitor temperature coefficient requirements within the operating temperature range.	※First, pre-heat: heat treat 60 $\pm$ 5 minutes at 150+0/-10°C, then set it for 24 $\pm$ 2 hours at room temperature. ※Measure the capacitance at 55~125°C or 55~85°C, the capacitance change ratio comparing to that of 20°C must be within the specified range.										
9	Solderability	Tin coverage 75% should be of the outer electrode covered by Tin	※Dip the capacitor into ethanol or colophony solution, and then dip it into 235 $\pm$ 5°C eutectic solder solution for 2 $\pm$ 0.5 seconds. Dipping speed: 25 $\pm$ 2.5mm/second.										
10	Resistance to Soldering	Appearance	No defects visible	※First pre-heat: heat treat for 60 $\pm$ 5 minutes at 150+0/-10°C, then set it for 24 $\pm$ 2 hours at room temperature. ※Then pre-heat the capacitance according to the following chart. Dip the capacitor into 265 $\pm$ 5°C eutectic solder solution for 10 $\pm$ 1 seconds. Then set it for 24 $\pm$ 2 hours at room temperature, then measure. Dipping speed: 25 $\pm$ 2.5mm/second. ※Preheat conditions:									
		Cap. Change ratio	$\leq \pm 5\%$ or $\pm 0.5PF$ whichever is bigger										
		DF	Same as original standard										
		IR	Same as original standard										
				<table border="1"> <thead> <tr> <th>Stage</th> <th>Temperature</th> <th>Time</th> </tr> </thead> <tbody> <tr> <td>1</td> <td>100°C—120°C</td> <td>1minutes</td> </tr> <tr> <td>2</td> <td>170°C—200°C</td> <td>1minutes</td> </tr> </tbody> </table>	Stage	Temperature	Time	1	100°C—120°C	1minutes	2	170°C—200°C	1minutes
Stage	Temperature	Time											
1	100°C—120°C	1minutes											
2	170°C—200°C	1minutes											

# 多層片式陶瓷電容器

## MULTILAYER CHIP CERAMIC CAPACITOR

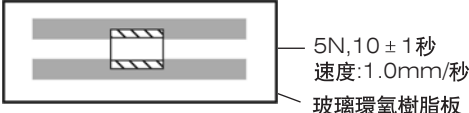
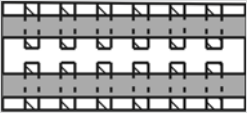
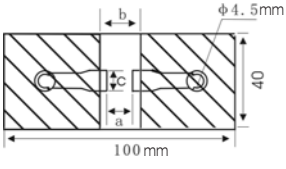
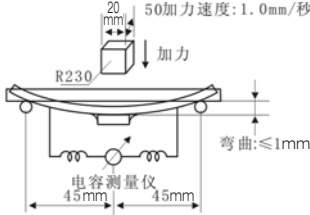
編號	項目	標準		測試方法																								
11	端電極結合強度	不應出現端頭脫落或其它缺陷。		<p>※使用混合焊錫將電容器焊接在圖 1 中所示的測試夾具（玻璃環氧樹脂板）上。然後沿箭頭方向施加 10N 的力。焊接應利用烙鐵或使用回流焊方法進行，而且應謹慎作業，以使焊接均勻且不會出現熱衝擊等不良現象。</p>  <p>圖1</p>																								
12	耐震動性	外觀	無明顯缺陷	<p>※將電容器焊接在測試夾具（玻璃環氧樹脂板）上。電容器應進行簡諧運動，其總幅值為 1.5mm，頻率在近似 10—55Hz 之間均勻變化。頻率範圍（從 10 至 55Hz 再返回 10Hz）應在約 1 分鐘內完成。振動應在三個相互垂直方向各進行 2 小時（總計 6 小時）。</p>  <p>圖2</p>																								
		電容量	在規定偏差範圍內																									
		D.F.	同初始標準																									
3	抗彎曲性能	不應出現裂縫或其他缺陷。	電容量變化率： 在 ±10% 範圍內	<p>※使用混合焊錫將電容器焊接在圖 3 中所示的測試夾具（玻璃環氧樹脂板）上，然後在圖 4 所示的方向加力。焊接應利用烙鐵或使用回流焊方法進行，而且應謹慎作業，以使焊接均勻且不會出現熱衝擊等不良現象。</p>  <p>圖3</p>  <p>圖4</p> <table border="1" data-bbox="869 1612 1220 1758"> <thead> <tr> <th rowspan="2">L×W (mm)</th> <th colspan="4">尺寸 (mm)</th> </tr> <tr> <th>a</th> <th>b</th> <th>c</th> <th>d</th> </tr> </thead> <tbody> <tr> <td>4.5×2.0</td> <td>3.5</td> <td>7.0</td> <td>2.4</td> <td></td> </tr> <tr> <td>4.5×3.2</td> <td>3.5</td> <td>7.0</td> <td>3.7</td> <td>1.0</td> </tr> <tr> <td>5.7×6.3</td> <td>4.5</td> <td>8.0</td> <td>5.6</td> <td></td> </tr> </tbody> </table>	L×W (mm)	尺寸 (mm)				a	b	c	d	4.5×2.0	3.5	7.0	2.4		4.5×3.2	3.5	7.0	3.7	1.0	5.7×6.3	4.5	8.0	5.6	
L×W (mm)	尺寸 (mm)																											
	a	b	c	d																								
4.5×2.0	3.5	7.0	2.4																									
4.5×3.2	3.5	7.0	3.7	1.0																								
5.7×6.3	4.5	8.0	5.6																									
14	溫度循環	外觀	無缺陷或異常	<p>※首先進行預處理：進行 150+0/-10℃ 熱處理 60 ± 5 分鐘，然後在室溫條件下放置 24 ± 2 小時。</p> <p>※按照下表中列出的四種熱處理方法執行五次循環。</p> <p>在室溫條件下放置 24 ± 2 小時，然後進行測量。</p>																								

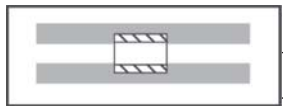
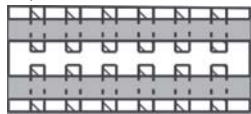
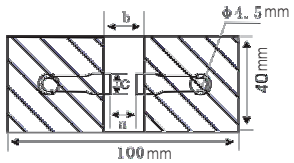
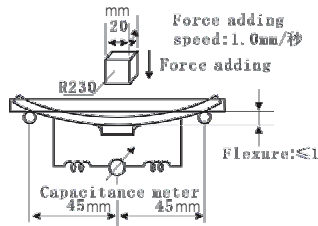
Number	Item	Standard		Test Method																						
11	Adhesive Strength of Termination	No removal of the termination or other defect shall occur		<p>※Solder the capacitor to the test jig (glass epoxy resin board) shown in Fig.1 using a eutectic solder. Then apply a 10N force in the direction shown as the arrowhead. The soldering shall be done either with an iron or using the reflow method and shall be conducted with care so that the soldering is uniform and free of defects such as heat shock, etc.</p>  <p>5N, 10±1s Speed: 1.0mm/s Glass epoxy resin board</p> <p>Fig. 1</p>																						
12	Vibration Resistance	Appearance	No defects or abnormalities	<p>※Solder the capacitor to the test jig (glass epoxy resin board). The capacitor should be subjected to a simple harmonic motion having a total amplitude of 1.5mm, the frequency being varied uniformly between the approximate limits of 10 and 55Hz, shall be traversed (from 10 Hz to 55 Hz then 10 Hz again) in approximately 1 minute. This motion shall be applied for a period of 2 hours in each 3 mutually perpendicular directions (total is 6 hours).</p>  <p>Fig. 2</p>																						
		Capacitance	Within the specified tolerance range																							
		DF	Same as original standard																							
13	Bending Resistance	No cracks or other defects shall occur		<p>※Solder the capacitor to the test jig (glass epoxy resin board) shown in Fig.3 using a eutectic solder. Then apply a force in the direction shown in Fig.4. The soldering shall be done either with an iron or using the reflow method and shall be conducted with care so that the soldering is uniform and free of defects such as heat shock, etc.</p>  <p>Fig. 3</p>  <p>Fig. 4</p>																						
		Cap. Change ratio : within ±10%																								
				<table border="1"> <thead> <tr> <th rowspan="2">L×W (mm)</th> <th colspan="4">Dimension</th> </tr> <tr> <th>a</th> <th>b</th> <th>c</th> <th>d</th> </tr> </thead> <tbody> <tr> <td>4.5×2.0</td> <td>3.5</td> <td>7.0</td> <td>2.4</td> <td rowspan="3">1.0</td> </tr> <tr> <td>4.5×3.2</td> <td>3.5</td> <td>7.0</td> <td>3.7</td> </tr> <tr> <td>5.7×6.3</td> <td>4.5</td> <td>8.0</td> <td>5.6</td> </tr> </tbody> </table>	L×W (mm)	Dimension				a	b	c	d	4.5×2.0	3.5	7.0	2.4	1.0	4.5×3.2	3.5	7.0	3.7	5.7×6.3	4.5	8.0	5.6
L×W (mm)	Dimension																									
	a	b	c	d																						
4.5×2.0	3.5	7.0	2.4	1.0																						
4.5×3.2	3.5	7.0	3.7																							
5.7×6.3	4.5	8.0	5.6																							
14	Temperature Cycle	Appearance	No defects or abnormalities	<p>※Pre-treatment: Heat-treat the capacitor for 60±5 minutes at 150+0/-10℃, then set it for 24±2 hours at room temperature.</p> <p>※Perform five cycles according to the four heat treatments listed in the following table. Set it for 24±2 hours at room temperature, the measure.</p>																						



## 多層片式陶瓷電容器

## MULTILAYER CHIP CERAMIC CAPACITOR

編號	項目	標準		測試方法															
14	溫度循環	電容量	$\leq \pm 1\%$ 或 $\pm 1\text{PF}$ , 取兩者中最大的。	熱處理方法如下表: <table border="1" style="margin-left: 20px;"> <thead> <tr> <th>階段</th> <th>溫度(℃)</th> <th>時間( min.)</th> </tr> </thead> <tbody> <tr> <td>1</td> <td>最低工作溫度 <math>\pm 3</math></td> <td><math>30 \pm 3</math></td> </tr> <tr> <td>2</td> <td>常溫</td> <td>2—3</td> </tr> <tr> <td>3</td> <td>最高工作溫度 <math>\pm 2</math></td> <td><math>30 \pm 3</math></td> </tr> <tr> <td>4</td> <td>常溫</td> <td>2—3</td> </tr> </tbody> </table>	階段	溫度(℃)	時間( min.)	1	最低工作溫度 $\pm 3$	$30 \pm 3$	2	常溫	2—3	3	最高工作溫度 $\pm 2$	$30 \pm 3$	4	常溫	2—3
		階段	溫度(℃)		時間( min.)														
		1	最低工作溫度 $\pm 3$		$30 \pm 3$														
2	常溫	2—3																	
3	最高工作溫度 $\pm 2$	$30 \pm 3$																	
4	常溫	2—3																	
D.F.	同初始標準																		
I.R.	大於10000MΩ																		
15	濕度(穩態)	外觀	無缺陷或異常	※在 $40 \pm 2^\circ\text{C}$ 和 90—95% 相對濕度條件下放置 $500 \pm 24/-0$ 小時。然後將其移動到室溫條件下恢復放置 $24 \pm 2$ 小時，進行測量。															
		電容量	$\leq \pm 2\%$ 或 $\pm 1\text{PF}$ , 取兩者中最大的。																
		D.F.	$\leq 2$ 倍初始標準																
		I.R.	$R_i \geq 2500\text{M}\Omega$ 或 $R_i * C_r \geq 25\text{S}$																
16	壽命	外觀	無缺陷或異常	※在上限溫度下施加1.5倍的額定工作電壓 $1000 \pm 12$ 小時，充放電電流不超過50mA。將其移動到室溫條件下恢復放置 $24 \pm 2$ 小時，進行測量。(若額定工作電壓 $> 2000\text{V}$ ，就施加1.2倍的額定工作電壓試驗。)															
		電容量	$\leq \pm 2\%$ 或 $\pm 1\text{PF}$ , 取兩者中最大的。																
		D.F.	$\leq 2$ 倍初始標準																
		I.R.	$R_i \geq 4000\text{M}\Omega$ 或 $R_i * C_r \geq 40\text{S}$																

Number	Items	Standard		Test Method															
14	Temperature Cycle	Cap. Change ratio	$\leq \pm 2\%$ or $\pm 1\text{PF}$ whichever is larger	※Heat-treatment: <table border="1"> <thead> <tr> <th>Stage</th> <th>Temperature (°C)</th> <th>Time (min.)</th> </tr> </thead> <tbody> <tr> <td>1</td> <td>lowest operating temperature <math>\pm 3</math></td> <td><math>30 \pm 3</math></td> </tr> <tr> <td>2</td> <td>Room Temperature</td> <td>2—3</td> </tr> <tr> <td>3</td> <td>Highes operating temperature <math>\pm 2</math></td> <td><math>30 \pm 3</math></td> </tr> <tr> <td>4</td> <td>Room Temperature</td> <td>2—3</td> </tr> </tbody> </table>	Stage	Temperature (°C)	Time (min.)	1	lowest operating temperature $\pm 3$	$30 \pm 3$	2	Room Temperature	2—3	3	Highes operating temperature $\pm 2$	$30 \pm 3$	4	Room Temperature	2—3
		Stage	Temperature (°C)		Time (min.)														
		1	lowest operating temperature $\pm 3$		$30 \pm 3$														
		2	Room Temperature		2—3														
3	Highes operating temperature $\pm 2$	$30 \pm 3$																	
4	Room Temperature	2—3																	
D.F.	Not more than twice of initial value																		
I.R.	More than $10000\text{M}\Omega$																		
15	Humidity Steady State	Appearance	No defects or abnormities	※Set the capacitor for $500+24/-0$ hours at the condition of $40 \pm 2^\circ\text{C}$ and 90-95% humidity. Then remove and set it for $24 \pm 2$ hours at room temperature, then measure.															
		Cap. Change ratio	$\leq \pm 2\%$ or $\pm 1\text{PF}$ whichever is larger																
		D.F.	Not more than twice of initial value																
		I.R.	$R_i \geq 2500\text{M}\Omega$ or $R_i \cdot C_R \geq 25\text{S}$																
16	Life Test	Appearance	No defects or abnormities	※Apply 1.5 times rated voltage to the capacitor for $1000 \pm 12$ hours at the upper temperature limits, the charging current should be less than 50mA. Remove and set it for $24 \pm 2$ hours at room temperature, then measure.(If $U_r > 2000\text{V}$ , apply 1.2times $U_r$ to test)															
		Cap. Change ratio	$\leq \pm 2\%$ or $\pm 1\text{PF}$ (whichever is larger)																
		D.F.	Not more than twice of initial value																
		I.R.	$R_i \geq 4000\text{M}\Omega$ or $R_i \cdot C_R \geq 40\text{S}$																

■ 直流中高壓X7R片容可靠性測試方法

編號	項目	標準	測試方法		
1	工作溫度範圍	-55℃ ~ 125℃			
2	外觀	1. 瓷體顏色一致性好。 2. 芯片無可見損傷,光滑平整。 3. 瓷體無外露電極,裂痕,孔洞。 4. 端電極無裂痕,孔洞,磨損及表面氧化等。 5. 端電極應無延伸現象或延伸部分不超過端頭寬度的一半。	※在 $\geq \times 10$ 倍以上的顯微鏡下觀察。		
3	尺寸	在規定尺寸範圍內	※使用千分尺或游標卡尺。		
4	電容量	在規定偏差範圍內	※測試儀器: HP4278A電橋、HP4284電橋。		
5	損耗因數(D.F.)	$\leq 250 \times 10^{-4}$	※測試條件: 1. 測試溫度: $25^\circ\text{C} \pm 5^\circ\text{C}$ , 濕度: 30% ~ 75%。 2. 測試電壓: $1.0 \pm 0.2\text{V}$ 。 3. 測試頻率: $1.0 \pm 0.1\text{KHz}$ 。		
6	絕緣電阻( I.R.)	$C < 25\text{nF}, I.R. \geq 10000\text{M}\Omega$ $C > 25\text{nF}, R \times C \geq 100\text{S}$	※測試儀器: 絕緣電阻測試儀(如: SF2511絕緣測試)。 ※測試方法: 施加額定工作電壓, 若額定工作電壓 $> 500\text{V}$ , 按 $500\text{V}$ 測試, 在 $60 \pm 5$ 秒內測量絕緣電阻。		
7	耐電壓強度	要求	額定電壓	最大充電電流	測試時間
		耐電壓值 $> 2$ 倍額定電壓	$100\text{V} \leq U_r < 500\text{V}$	50mA	5S
		耐電壓值 $> 1.5$ 倍額定電壓	$500\text{V} \leq U_r < 1000\text{V}$	50mA	5S
		耐電壓值 $> 1.2$ 倍額定電壓	$1000\text{V} < U_r \leq 2000\text{V}$	50mA	5S
耐電壓值 $> 1.2$ 倍額定電壓	$> 2000\text{V}$	10mA	5S		
8	電容量溫度特性	在工作溫度範圍內符合電容器特性溫度系數要求	※首先進行預處理: 進行 $150 \pm 0/-10^\circ\text{C}$ 熱處理 $60 \pm 5$ 分鐘, 然后在室溫條件下放置 $24 \pm 2$ 小時。 ※在 $-55 \sim 125^\circ\text{C}$ 範圍內測試電容量, 其電容值相對於 $20^\circ\text{C}$ 時數值的變化率應在規定範圍內。		
9	可焊性	75% 端電極覆蓋錫	※將電容器浸在乙醇和松香溶液中。然後浸入 有鉛 $235 \pm 5^\circ\text{C}$ (無鉛 $245 \pm 5^\circ\text{C}$ ) 的混合焊錫溶液 $2 \pm 0.5$ 秒。 浸入速度: $25 \pm 2.5\text{mm/秒}$ 。		

## General X7R MLCC reliability test method

Number	Item	Standard	Test Method		
1	Operating Temperature Range	-55°C~125°C			
2	Appearance	1. Good ceramic body color continuity. 2. The chips have no visual damages and must be very smooth. 3. No exposed inner- electrode, no cracks or holes. 4. The outer electrode should have no cracks, holes, damages or surface oxidation. 5. Outer electrode no prolongation or the prolongation is less than half of the termination width.	※Check by using microscope $\geq \times 10$ .		
3	Dimensions	Within the specified dimensions	※Using micrometer or vernier calipers		
4	Capacitance	Within the specified tolerance	※Measuring Equipments: HP4278 capacitance meter, HP4284 capacitance, ※Measuring Conditions: 1. Measuring Temperature: $25^{\circ}\text{C} \pm 5^{\circ}\text{C}$ . Humidity: 30%~75%. 2. Measuring Voltage: $1.0 \pm 0.2\text{V}$ . 3. Measuring Frequency: $1.0 \pm 0.1\text{KHz}$		
5	Dissipation Factor (DF)	$250 \times 10^{-4}$			
6	Insulation Resistance	$C \leq 25\text{nF}, IR \geq 10000\text{M}\Omega$ $C > 25\text{nF}, R \times C \geq 100\text{S}$	※Measuring Equipment: Insulation resistance meter (such as Sf2511 insulation resistance). ※Measuring Method: Must measure at rated voltage, and measure the IR within $60 \pm 1$ seconds.		
7	Withstanding Voltage	Requirement	Ur	Max. Current	Measuring Time
		$> 2U_r$	$100 \leq U_r < 5000\text{V}$	50mA	5S
		$> 1.5U_r$	$500\text{V} \leq U_r \leq 1000\text{V}$	50mA	5S
		$> 1.2U_r$	$1000\text{V} < U_r \leq 2000\text{V}$	50mA	5S
		$> 1.2U_r$	$> 2000\text{V}$	10mA	5S
8	Capacitance Temperature Characteristics	Must meet the capacitor character temperature coefficient requirements within the operating temperature range.	※First, pre-heat: heat treat $60 \pm 5$ minutes at $150 + 0 / - 10^{\circ}\text{C}$ , then set it for $24 \pm 2$ hours at room temperature. ※Measure the capacitance at $-55 \sim 125^{\circ}\text{C}$ , the capacitance change ratio comparing to that of $20^{\circ}\text{C}$ must be within the specified range.		
9	Solderability	75% of the outer electrode should be covered by Tin	※Dip the capacitor into ethanol or colophony solution, and then dip it into $245 \pm 5^{\circ}\text{C}$ eutectic solder solution for $2 \pm 0.5$ seconds. Dipping speed: $25 \pm 2.5\text{mm/second}$ .		

# 多層片式陶瓷電容器

## MULTILAYER CHIP CERAMIC CAPACITOR

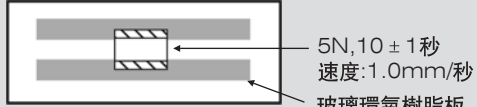
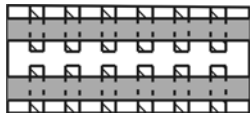
編號	項目	標準		測試方法
10	耐焊接熱	外觀	無明顯缺陷	※首先進行預處理：進行 $150 \pm 0 / -10^{\circ}\text{C}$ 熱處理 $60 \pm 5$ 分鐘，然后在室溫條件下放置 $24 \pm 2$ 小時。 ※然後按下表預熱電容器。將電容器浸入 $265 \pm 5^{\circ}\text{C}$ 的混合焊錫溶液 $10 \pm 1$ 秒。再在室溫條件下放置 $24 \pm 2$ 小時，然後進行測量。 浸入速度： $25 \pm 2.5\text{mm/秒}$ 。 ※預熱條件如下：
		電容量變化率	在 $\pm 10\%$ 範圍內	
		D.F.	同初始標準	
		I.R.	同初始標準	
11	端電極結合強度	不應出現端電極脫落或其它缺陷。		※使用混合焊錫將電容器焊接在圖 1 中所所示的測試夾具（玻璃環氧樹脂板）上。然後沿箭頭方向施加 $10\text{N}$ 的力。焊接應利用烙鐵或使用回流焊方法進行，而且應謹慎作業，以使焊接均勻且不會出現熱衝擊等不良現象。
				圖 1
12	耐振動性	外觀	無缺陷或異常	※將電容器焊接在測試夾具（玻璃環氧樹脂板）上。電容器應進行簡諧運動，其總幅值為 $1.5\text{mm}$ ，頻率在近似 $10\text{—}55\text{Hz}$ 之間均勻變化。頻率範圍（從 $10$ 至 $55\text{Hz}$ 再返回 $10\text{Hz}$ ）應在約 1 分鐘內完成。振動應在三個相互垂直方向各進行 2 小時（總計 6 小時）。
		電容量	在規定偏差範圍內	
		D.F.	同初始標準	
13	抗彎曲性能	不應出現裂痕或其他缺陷		※使用混合焊錫將電容器焊接在圖 3 中所所示的測試夾具（玻璃環氧樹脂板）上，然後在圖 4 所示的方向加力。焊接應利用烙鐵或使用回流焊方法進行，而且應謹慎作業，以使焊接均勻且不會出現熱衝擊等不良現象。
				圖 2

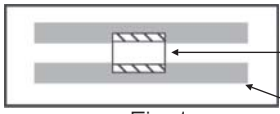
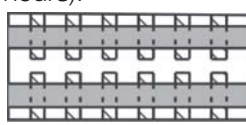
Number	Item	Standard		Test Method									
10	Resistance to Soldering	Appearance	No defects visible	※First pre-heat: heat treat for $60 \pm 5$ minutes at $150 + 0 / - 10^\circ\text{C}$ , then set it for $24 \pm 2$ hours at room temperature. ※Then pre-heat the capacitance according to the following chart. Dip the capacitor into $265 \pm 5^\circ\text{C}$ eutectic solder solution for $10 \pm 1\text{s}$ . Then set it for $24 \pm 2$ hours at room temperature, then measure. Dipping speed: $25 \pm 2.5\text{mm/second}$ . ※Preheat conditions: <table border="1" style="margin-left: 20px;"> <thead> <tr> <th>Stage</th> <th>Temperature</th> <th>Time</th> </tr> </thead> <tbody> <tr> <td>1</td> <td><math>100^\circ\text{C} - 120^\circ\text{C}</math></td> <td>1minute</td> </tr> <tr> <td>2</td> <td><math>170^\circ\text{C} - 200^\circ\text{C}</math></td> <td>1minute</td> </tr> </tbody> </table>	Stage	Temperature	Time	1	$100^\circ\text{C} - 120^\circ\text{C}$	1minute	2	$170^\circ\text{C} - 200^\circ\text{C}$	1minute
		Stage	Temperature		Time								
		1	$100^\circ\text{C} - 120^\circ\text{C}$		1minute								
		2	$170^\circ\text{C} - 200^\circ\text{C}$		1minute								
Cap. Change ratio	Within $\pm 10\%$												
DF	Same as original spec.												
	IR	Same as original spec.											
11	Adhesive Strength of Termination	No removal of the terminations or other defect shall occur		※Solder the capacitor to the test jig (glass epoxy resin board) shown in Fig.1 using a eutectic solder. Then apply a 10N force in the direction shown as the arrowhead. The soldering shall be done either with an iron or using the reflow method and shall be conducted with care so that the soldering is uniform and free of defects such as heat shock, etc. <div style="text-align: center;">  <p>Fig.1</p> </div>									
12	Resistance to Soldering	Appearance	No defects visible or abnormalities	※Solder the capacitor to the test jig (glass epoxy resin board). The capacitor should be subjected to a simple harmonic motion having a total amplitude of 1.5mm, the frequency being varied uniformly between the approximate limits of 10 and 55Hz, shall be traversed (from 10 Hz to 55 Hz then 10 Hz again) in approximately 1 minute. This motion shall be applied for a period of 2 hours in each 3 mutually perpendicular directions (total is 6 hours). <div style="text-align: center;">  <p>Fig.2</p> </div>									
		Capacitance	Within the specified tolerance range										
		D.F.	Same as original spec.										
13	Bending Resistance	No cracks or other defects shall occur		※Solder the capacitor to the test jig (glass epoxy resin board) shown in Fig.3 using a eutectic solder. Then apply a force in the direction shown as Fig.4. The soldering shall be done either with an iron or using the reflow method and shall be conducted with care so that the soldering is uniform and free of defects such as heat shock, etc.									

# 多層片式陶瓷電容器

## MULTILAYER CHIP CERAMIC CAPACITOR

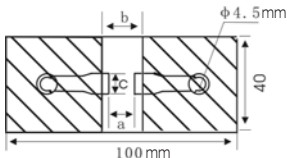
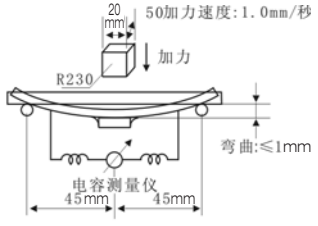
編號	項目	標準	測試方法																							
13	抗彎曲性能	電容量變化率: 在 ± 10% 範圍內	  <p>图3</p> <p>图4</p> <table border="1"> <thead> <tr> <th rowspan="2">L×W (mm)</th> <th colspan="4">尺寸 (mm)</th> </tr> <tr> <th>a</th> <th>b</th> <th>c</th> <th>d</th> </tr> </thead> <tbody> <tr> <td>4.5×2.0</td> <td>3.5</td> <td>7.0</td> <td>2.4</td> <td rowspan="3">1.0</td> </tr> <tr> <td>4.5×3.2</td> <td>3.5</td> <td>7.0</td> <td>3.7</td> </tr> <tr> <td>5.7×6.3</td> <td>4.5</td> <td>8.0</td> <td>5.6</td> </tr> </tbody> </table>	L×W (mm)	尺寸 (mm)				a	b	c	d	4.5×2.0	3.5	7.0	2.4	1.0	4.5×3.2	3.5	7.0	3.7	5.7×6.3	4.5	8.0	5.6	
L×W (mm)	尺寸 (mm)																									
	a	b	c	d																						
4.5×2.0	3.5	7.0	2.4	1.0																						
4.5×3.2	3.5	7.0	3.7																							
5.7×6.3	4.5	8.0	5.6																							
14	溫度循環	<table border="1"> <tr> <td>外觀</td> <td>無缺陷或異常</td> </tr> <tr> <td>電容量變化率</td> <td>在 ± 10% 範圍內</td> </tr> <tr> <td>D.F.</td> <td>同初始標準</td> </tr> <tr> <td>I.R.</td> <td>同初始標準</td> </tr> </table>	外觀	無缺陷或異常	電容量變化率	在 ± 10% 範圍內	D.F.	同初始標準	I.R.	同初始標準	<table border="1"> <thead> <tr> <th>階段</th> <th>溫度 ( °C )</th> <th>時間 ( min. )</th> </tr> </thead> <tbody> <tr> <td>1</td> <td>最低工作溫度 ± 3</td> <td>30 ± 3</td> </tr> <tr> <td>2</td> <td>常溫</td> <td>2—3</td> </tr> <tr> <td>3</td> <td>最高工作溫度 ± 2</td> <td>30 ± 3</td> </tr> <tr> <td>4</td> <td>常溫</td> <td>2—3</td> </tr> </tbody> </table>	階段	溫度 ( °C )	時間 ( min. )	1	最低工作溫度 ± 3	30 ± 3	2	常溫	2—3	3	最高工作溫度 ± 2	30 ± 3	4	常溫	2—3
外觀	無缺陷或異常																									
電容量變化率	在 ± 10% 範圍內																									
D.F.	同初始標準																									
I.R.	同初始標準																									
階段	溫度 ( °C )	時間 ( min. )																								
1	最低工作溫度 ± 3	30 ± 3																								
2	常溫	2—3																								
3	最高工作溫度 ± 2	30 ± 3																								
4	常溫	2—3																								
15	濕度(穩態)	<table border="1"> <tr> <td>外觀</td> <td>無缺陷或異常</td> </tr> <tr> <td>電容量變化率</td> <td>在 ± 10% 範圍內</td> </tr> <tr> <td>D.F.</td> <td>≤ 2倍初始標準</td> </tr> <tr> <td>I.R.</td> <td>Ri ≥ 1000MΩ 或 Ri * Cr ≥ 25S</td> </tr> </table>	外觀	無缺陷或異常	電容量變化率	在 ± 10% 範圍內	D.F.	≤ 2倍初始標準	I.R.	Ri ≥ 1000MΩ 或 Ri * Cr ≥ 25S	<p>※在 40 ± 2°C 和 90—95% 相對濕度條件下放置 500 ± 24/-0 小時。然後將其移動到室溫條件下恢復放置 48 ± 2 小時，進行測量。</p>															
外觀	無缺陷或異常																									
電容量變化率	在 ± 10% 範圍內																									
D.F.	≤ 2倍初始標準																									
I.R.	Ri ≥ 1000MΩ 或 Ri * Cr ≥ 25S																									
16	壽命	<table border="1"> <tr> <td>外觀</td> <td>無缺陷或異常</td> </tr> <tr> <td>電容量變化率</td> <td>在 ± 20% 範圍內</td> </tr> <tr> <td>D.F.</td> <td>≤ 2倍初始標準</td> </tr> <tr> <td>I.R.</td> <td>Ri ≥ 2000MΩ 或 Ri * Cr ≥ 50S</td> </tr> </table>	外觀	無缺陷或異常	電容量變化率	在 ± 20% 範圍內	D.F.	≤ 2倍初始標準	I.R.	Ri ≥ 2000MΩ 或 Ri * Cr ≥ 50S	<p>※在上限溫度下施加 1.5 倍的額定工作電壓 1000 ± 12 小時，充放電電流不超過 50mA。將其移動到室溫條件下恢復放置 24 ± 2 小時，進行測量。(若額定工作電壓 &gt; 2000V，就施加 1.2 倍的額定工作電壓試驗。)</p>															
外觀	無缺陷或異常																									
電容量變化率	在 ± 20% 範圍內																									
D.F.	≤ 2倍初始標準																									
I.R.	Ri ≥ 2000MΩ 或 Ri * Cr ≥ 50S																									

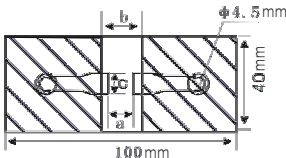
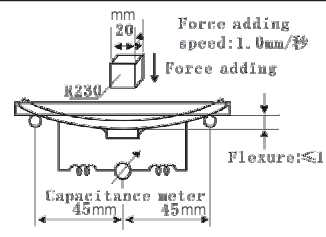
Number	Item	Standard		Test Method																						
13	Bending Resistance	Cap. Change ratio : within $\pm 10\%$		  <table border="1" data-bbox="861 604 1204 750"> <thead> <tr> <th rowspan="2">L×W (mm)</th> <th colspan="4">Dimension</th> </tr> <tr> <th>a</th> <th>b</th> <th>c</th> <th>d</th> </tr> </thead> <tbody> <tr> <td>4.5×2.0</td> <td>3.5</td> <td>7.0</td> <td>2.4</td> <td rowspan="3">1.0</td> </tr> <tr> <td>4.5×3.2</td> <td>3.5</td> <td>7.0</td> <td>3.7</td> </tr> <tr> <td>5.7×6.3</td> <td>4.5</td> <td>8.0</td> <td>5.6</td> </tr> </tbody> </table>	L×W (mm)	Dimension				a	b	c	d	4.5×2.0	3.5	7.0	2.4	1.0	4.5×3.2	3.5	7.0	3.7	5.7×6.3	4.5	8.0	5.6
L×W (mm)	Dimension																									
	a	b	c	d																						
4.5×2.0	3.5	7.0	2.4	1.0																						
4.5×3.2	3.5	7.0	3.7																							
5.7×6.3	4.5	8.0	5.6																							
14	Temperature Cycle	Appearance	No defects or abnormalities	<table border="1" data-bbox="774 772 1428 929"> <thead> <tr> <th>Stage</th> <th>Temperature (°C)</th> <th>Time (min.)</th> </tr> </thead> <tbody> <tr> <td>1</td> <td>Min. Operating Temperature <math>\pm 3</math></td> <td>30 <math>\pm</math> 3</td> </tr> <tr> <td>2</td> <td>Room Temperature</td> <td>2—3</td> </tr> <tr> <td>3</td> <td>Max. Operating Temperature 2</td> <td>30 <math>\pm</math> 3</td> </tr> <tr> <td>4</td> <td>Room Temperature</td> <td>2—3</td> </tr> </tbody> </table>	Stage	Temperature (°C)	Time (min.)	1	Min. Operating Temperature $\pm 3$	30 $\pm$ 3	2	Room Temperature	2—3	3	Max. Operating Temperature 2	30 $\pm$ 3	4	Room Temperature	2—3							
Stage	Temperature (°C)	Time (min.)																								
1	Min. Operating Temperature $\pm 3$	30 $\pm$ 3																								
2	Room Temperature	2—3																								
3	Max. Operating Temperature 2	30 $\pm$ 3																								
4	Room Temperature	2—3																								
	Cap. Change ratio	Within $\pm 10\%$																								
	D.F.	Same as original Specification																								
	I.R.	Same as original Specification																								
15	Humidity Steady State	Appearance	No defects or abnormalities	※Set the capacitor for 500 $\pm$ 24/-0 hours at the condition of 40 $\pm$ 2°C and 90-95% humidity. Then remove and set it for 48 $\pm$ 2 hours at room temperature, then measure.																						
	Cap. Change ratio	within $\pm 10\%$																								
	D.F.	Not more than twice of initial value																								
	I.R.	$R_i \geq 1000M \Omega$ or $R_i \cdot C_R \geq 25S$																								
16	Life Test	Appearance	No defects or abnormalities	※Apply 1.5 times rated voltage to the capacitor for 1000 $\pm$ 12 hours at the upper temperature limits, the charging current should be less than 50mA. Remove and set it for 24 $\pm$ 2 hours at room temperature, then measure.(If $U_r > 2000V$ , apply 1.2 $U_r$ to test.)																						
	Cap. Change ratio	within $\pm 20\%$																								
	D.F.	Not more than twice of initial value																								
	I.R.	$R_i \geq 2000M \Omega$ or $R_i \cdot C_R \geq 50S$																								



■ 直流中高壓Y5V片容可靠性測試方法

編號	項目	標準	測試方法		
1	工作溫度範圍	-25℃~85℃			
2	外觀	1.瓷體顏色一致性好。 2.芯片無可見損傷,光滑平整。 3.瓷體無外露電極,裂痕,孔洞。 4.端電極無裂痕,孔洞,磨損及表面氧化等。 5.端電極應無延伸現象或延伸部分不超過端頭寬度的一半。	※在 $\geq \times 10$ 倍以上的顯微鏡下觀察。		
3	尺寸	在規定尺寸範圍內	※使用千分尺或游標卡尺。		
4	電容量	在規定偏差範圍內	※測試儀器: HP4278A電橋、HP4284電橋。		
5	損耗因數(D.F.)	$\leq 700 \times 10^{-4}$ ( $C < 1.0 \mu F$ ) $\leq 900 \times 10^{-4}$ ( $C > 1.0 \mu F$ )	※測試條件: 1.測試溫度: $25^\circ C \pm 5^\circ C$ , 濕度:30%~75%。 2.測試電壓: $1.0 \pm 0.2V$ 。 3.測試頻率: $1.0 \pm 0.1kHz$ 。		
6	絕緣電阻(I.R.)	$C \leq 25nF, IR \geq 4000M\Omega$ $C > 25nF, R \times C \geq 100S$	※測試儀器: 絕緣電阻測試儀(如: SF2511絕緣測試)。 ※測試方法: 施加額定工作電壓,在 $60 \pm 5$ 秒內測量絕緣電阻。		
7	耐電壓強度	要求	額定電壓	最大充電電流	測試時間
		耐電壓值 $> 2$ 倍額定電壓	$100V \leq U_r < 500V$	50mA	5S
		耐電壓值 $> 1.5$ 倍額定電壓	$500V \leq U_r \leq 1000V$	50mA	5S
		耐電壓值 $> 1.2$ 倍額定電壓	$1000V < U_r \leq 2000V$	50mA	5S
耐電壓值 $> 1.2$ 倍額定電壓	$> 2000V$	10mA	5S		
8	電容量溫度特性	在工作溫度範圍內符合電容器特性溫度系數要求	※首先進行預處理: 進行 $150 \pm 0/-10^\circ C$ 熱處理 $60 \pm 5$ 分鐘, 然后在室溫條件下放置 $24 \pm 2$ 小時。 ※在 $-25 \sim 85^\circ C$ 範圍內測試電容量, 其電容值相對於 $20^\circ C$ 時數值的變化率應在規定範圍內。		
9	可焊性	75% 端電極覆蓋錫	※將電容器浸在乙醇和松香溶液中。 然後浸入有鉛 $235 \pm 5^\circ C$ (無鉛 $245 \pm 5^\circ C$ )的混合焊錫溶液 $2 \pm 0.5$ 秒。浸入速度: $25 \pm 2.5mm/秒$ 。		



■ General Y5V MLCC reliability test method

Number	Item	Standard	Test Method		
1	Operating Temperature Range	-25°C~85°C			
2	Appearance	1.Good ceramic body color continuity. 2.The chips have no visual damages and must be very smooth. 3.No exposed inner- electrode, no cracks or holes. 4.The outer electrode should have no cracks, holes, damages or surface oxidation. 5.Outer electrode no prolongation or the prolongation is less than half of that of the termination width.	※Check by using microscope $\geq \times 10$ .		
3	Dimensions	Within the specified dimensions	※Using micrometer or vernier calipers		
4	Capacitance)	Within the specified tolerance	※Measuring Equipments: HP4278 capacitance meter, HP4284 capacitance, ※Measuring Conditions: 1.Measuring Temperature: 25°C $\pm$ 5°C. Humidity: 30%~75%. 2.Measuring Voltage: 1.0 $\pm$ 0.2V. 3.Measuring Frequency: 1.0 $\pm$ 0.1KHz		
5	Dissipation Factor (DF)	$\leq 700 \times 10^{-4}$ (C<1.0 $\mu$ F) $\leq 900 \times 10^{-4}$ (C>1.0 $\mu$ F)			
6	Insulation Resistance	C $\leq$ 25nF,IR $\geq$ 4000M $\Omega$ C>25nF,R $\times$ C $\geq$ 100S	※Measuring Equipment: Insulation resistance meter (such as Sf2511 insulation resistance). ※Measuring Method: Must measure at rated voltage, and measure the IR within 60 $\pm$ 5seconds.		
7	Withstanding Voltage	Requirement	Ur	Max. Current	Measuring Time
		>2Ur	100V $\leq$ Ur<500V	50mA	5S
		>1.5Ur	500V $\leq$ Ur $\leq$ 1000V	50mA	5S
		>1.2Ur	1000V<Ur $\leq$ 2000V	50mA	5S
>1.2Ur	>2000V	10mA	5S		
8	Capacitance Temperature Characteristics	Must meet the capacitor temperature coefficient requirements within the operating temperature range.	※First, pre-heat: heat treat 60 $\pm$ 5 minutes at 150+0/-10°C, then set it for 24 $\pm$ 2 hours at room temperature. ※Measure the capacitance at 55~125°C or 55~85°C,the capacitance change ratio comparing to that of 20°C must be within the specified range.		
9	Solderability	75% of the outer electrode should be covered by Tin	※Dip the capacitor into ethanol or colophony solution,and then dip it into 235 $\pm$ 5°C(or 245 $\pm$ 5°C leadless eutectic solder solution) eutectic solder solution hanging lead for 2 $\pm$ 0.5seconds. Dipping speed: 25 $\pm$ 2.5mm/second.		

# 多層片式陶瓷電容器

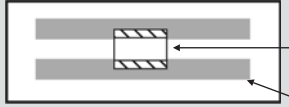
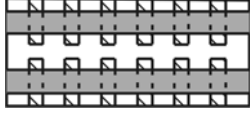
## MULTILAYER CHIP CERAMIC CAPACITOR

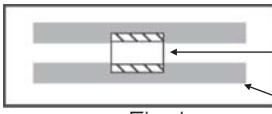
編號	項目	標準		測試方法									
10	耐焊接熱	外觀	無明顯缺陷	※首先進行預處理：進行 $150 \pm 0 / -10^{\circ}\text{C}$ 熱處理 $60 \pm 5$ 分鐘，然后在室溫條件下放置 $24 \pm 2$ 小時。 ※然後按下表預熱電容器。將電容器浸入 $265 \pm 5^{\circ}\text{C}$ 的混合焊錫溶液 $10 \pm 1$ 秒。再在室溫條件下放置 $24 \pm 2$ 小時，然後進行測量。 浸入速度： $25 \pm 2.5\text{mm/秒}$ 。 ※預熱條件如下：									
		電容量變化率	在 $-10\% \sim +20\%$ 範圍內										
		D.F.	同初始標準										
		I.R.	同初始標準										
				<table border="1"> <thead> <tr> <th>階段</th> <th>溫度</th> <th>時間</th> </tr> </thead> <tbody> <tr> <td>1</td> <td><math>100^{\circ}\text{C} \sim 120^{\circ}\text{C}</math></td> <td>1分鐘</td> </tr> <tr> <td>2</td> <td><math>170^{\circ}\text{C} \sim 200^{\circ}\text{C}</math></td> <td>1分鐘</td> </tr> </tbody> </table>	階段	溫度	時間	1	$100^{\circ}\text{C} \sim 120^{\circ}\text{C}$	1分鐘	2	$170^{\circ}\text{C} \sim 200^{\circ}\text{C}$	1分鐘
階段	溫度	時間											
1	$100^{\circ}\text{C} \sim 120^{\circ}\text{C}$	1分鐘											
2	$170^{\circ}\text{C} \sim 200^{\circ}\text{C}$	1分鐘											
11	端電極結合強度	不應出現端電極脫落或其它缺陷。		※使用混合焊錫將電容器焊接在圖 1 中所示的測試夾具（玻璃環氧樹脂板）上。然後沿箭頭方向施加 10N 的力。焊接應利用烙鐵或使用回流焊方法進行，而且應謹慎作業，以使焊接均勻且不會出現熱衝擊等不良現象。									
				 <p>圖 1</p>									
12	耐振動性	外觀	無缺陷或異常	※將電容器焊接在測試夾具（玻璃環氧樹脂板）上。電容器應進行簡諧運動，其總幅值為 1.5mm，頻率在近似 $10 \sim 55\text{Hz}$ 之間均勻變化。頻率範圍（從 10 至 55Hz 再返回 10Hz）應在約 1 分鐘內完成。振動應在三個相互垂直方向各進行 2 小時（總計 6 小時）。									
		電容量	在規定偏差範圍內										
		D.F.	同初始標準										
				 <p>圖 2</p>									
13	抗彎曲性能	不應出現裂痕或其他缺陷		※使用混合焊錫將電容器焊接在圖 3 中所示的測試夾具（玻璃環氧樹脂板）上，然後在圖 4 所示的方向加力。焊接應利用烙鐵或使用回流焊方法進行，而且應謹慎作業，以使焊接均勻且不會出現熱衝擊等不良現象。									

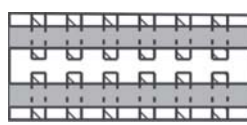
Number	Item	Standard		Test Method									
10	Resistance to Soldering	Appearance	No defects visible	※First pre-heat: heat treat for $60 \pm 5$ minutes at $150 + 0 / - 10^\circ\text{C}$ , then set it for $24 \pm 2$ hours at room temperature. ※Then pre-heat the capacitance according to the following chart. Dip the capacitor into $265 \pm 5^\circ\text{C}$ eutectic solder solution for $10 \pm 1$ s. Then set it for $24 \pm 2$ hours at room temperature, then measure. Dipping speed: $25 \pm 2.5$ mm/second. ※Preheat conditions: <table border="1" style="margin-left: 20px;"> <thead> <tr> <th>Stage</th> <th>Temperature</th> <th>Time</th> </tr> </thead> <tbody> <tr> <td>1</td> <td><math>100^\circ\text{C} - 120^\circ\text{C}</math></td> <td>1 minute</td> </tr> <tr> <td>2</td> <td><math>170^\circ\text{C} - 200^\circ\text{C}</math></td> <td>1 minute</td> </tr> </tbody> </table>	Stage	Temperature	Time	1	$100^\circ\text{C} - 120^\circ\text{C}$	1 minute	2	$170^\circ\text{C} - 200^\circ\text{C}$	1 minute
		Stage	Temperature		Time								
		1	$100^\circ\text{C} - 120^\circ\text{C}$		1 minute								
		2	$170^\circ\text{C} - 200^\circ\text{C}$		1 minute								
Cap. Change ratio	Z5U, Y5V: within $-10\% \sim +20\%$												
DF	Same as original spec.												
	IR	Same as original spec.											
11	Adhesive Strength of Termination	No removal of the terminations or other defects shall occur		※Solder the capacitor to the test jig (glass epoxy resin board) shown in Fig.1 using a eutectic solder. Then apply a 10N force in the direction shown as the arrowhead. The soldering shall be done either with an iron or using the reflow method and shall be conducted with care so that the soldering is uniform and free of defects such as heat shock, etc. <div style="text-align: right; margin-top: 10px;">  <p>5N, <math>10 \pm 1</math> s Speed: 1.0mm/s Glass epoxy resinboard</p> </div>									
													
12	Resistance to Soldering	Appearance	No defects visible or abnormalities	※Solder the capacitor to the test jig (glass epoxy resin board). The capacitor should be subjected to a simple harmonic motion having a total amplitude of 1.5mm, the frequency being varied uniformly between the approximate limits of 10 and 55Hz, shall be traversed (from 10 Hz to 55 Hz then 10 Hz again) in approximately 1 minute. This motion shall be applied for a period of 2 hours in each 3 mutually perpendicular directions (total is 6 hours). <div style="text-align: center; margin-top: 10px;">  </div>									
		Capacitance	Within the specified tolerance range										
		D.F.	Same as original spec.										
13	Bending Resistance	No cracks or other defects shall occur		※Solder the capacitor to the test jig (glass epoxy resin board) shown in Fig.3 using a eutectic solder. Then apply a force in the direction shown as Fig.4. The soldering shall be done either with an iron or using the reflow method and shall be conducted with care so that the soldering is uniform and free of defects such as heat shock, etc.									

# 多層片式陶瓷電容器

## MULTILAYER CHIP CERAMIC CAPACITOR

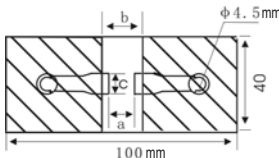
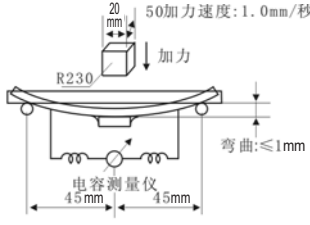
編號	項目	標準	測試方法																							
13	抗彎曲性能	電容量變化率: 在 ± 10% 範圍內	  <p>图3</p> <p>图4</p> <table border="1" data-bbox="885 638 1236 784"> <thead> <tr> <th rowspan="2">L×W (mm)</th> <th colspan="4">尺寸 (mm)</th> </tr> <tr> <th>a</th> <th>b</th> <th>c</th> <th>d</th> </tr> </thead> <tbody> <tr> <td>4.5×2.0</td> <td>3.5</td> <td>7.0</td> <td>2.4</td> <td rowspan="3">1.0</td> </tr> <tr> <td>4.5×3.2</td> <td>3.5</td> <td>7.0</td> <td>3.7</td> </tr> <tr> <td>5.7×6.3</td> <td>4.5</td> <td>8.0</td> <td>5.6</td> </tr> </tbody> </table>	L×W (mm)	尺寸 (mm)				a	b	c	d	4.5×2.0	3.5	7.0	2.4	1.0	4.5×3.2	3.5	7.0	3.7	5.7×6.3	4.5	8.0	5.6	
L×W (mm)	尺寸 (mm)																									
	a	b	c	d																						
4.5×2.0	3.5	7.0	2.4	1.0																						
4.5×3.2	3.5	7.0	3.7																							
5.7×6.3	4.5	8.0	5.6																							
14	溫度循環	<table border="1"> <tr> <td>外觀</td> <td>無缺陷或異常</td> </tr> <tr> <td>電容量變化率</td> <td>在 ± 20% 範圍內</td> </tr> <tr> <td>D.F.</td> <td>同初始標準</td> </tr> <tr> <td>I.R.</td> <td>同初始標準</td> </tr> </table>	外觀	無缺陷或異常	電容量變化率	在 ± 20% 範圍內	D.F.	同初始標準	I.R.	同初始標準	<table border="1"> <thead> <tr> <th>階段</th> <th>溫度 ( °C )</th> <th>時間 ( min. )</th> </tr> </thead> <tbody> <tr> <td>1</td> <td>最低工作溫度 ± 3</td> <td>30 ± 3</td> </tr> <tr> <td>2</td> <td>常溫</td> <td>2—3</td> </tr> <tr> <td>3</td> <td>最高工作溫度 ± 2</td> <td>30 ± 3</td> </tr> <tr> <td>4</td> <td>常溫</td> <td>2—3</td> </tr> </tbody> </table>	階段	溫度 ( °C )	時間 ( min. )	1	最低工作溫度 ± 3	30 ± 3	2	常溫	2—3	3	最高工作溫度 ± 2	30 ± 3	4	常溫	2—3
外觀	無缺陷或異常																									
電容量變化率	在 ± 20% 範圍內																									
D.F.	同初始標準																									
I.R.	同初始標準																									
階段	溫度 ( °C )	時間 ( min. )																								
1	最低工作溫度 ± 3	30 ± 3																								
2	常溫	2—3																								
3	最高工作溫度 ± 2	30 ± 3																								
4	常溫	2—3																								
15	濕度(穩態)	<table border="1"> <tr> <td>外觀</td> <td>無缺陷或異常</td> </tr> <tr> <td>電容量變化率</td> <td>在 ± 30% 範圍內</td> </tr> <tr> <td>D.F.</td> <td>≤ 2倍初始標準</td> </tr> <tr> <td>I.R.</td> <td>Ri ≥ 1000MΩ 或 Ri * C<sub>r</sub> ≥ 25S</td> </tr> </table>	外觀	無缺陷或異常	電容量變化率	在 ± 30% 範圍內	D.F.	≤ 2倍初始標準	I.R.	Ri ≥ 1000MΩ 或 Ri * C <sub>r</sub> ≥ 25S	<p>※在 40 ± 2°C 和 90—95% 相對濕度條件下放置 500+24/-0 小時。然後將其移動到室溫條件下恢復放置 48 ± 2 小時，進行測量。</p>															
外觀	無缺陷或異常																									
電容量變化率	在 ± 30% 範圍內																									
D.F.	≤ 2倍初始標準																									
I.R.	Ri ≥ 1000MΩ 或 Ri * C <sub>r</sub> ≥ 25S																									
16	壽命	<table border="1"> <tr> <td>外觀</td> <td>無缺陷或異常</td> </tr> <tr> <td>電容量變化率</td> <td>在 ± 30% 範圍內</td> </tr> <tr> <td>D.F.</td> <td>≤ 2倍初始標準</td> </tr> <tr> <td>I.R.</td> <td>Ri ≥ 2000MΩ 或 Ri * C<sub>r</sub> ≥ 50S</td> </tr> </table>	外觀	無缺陷或異常	電容量變化率	在 ± 30% 範圍內	D.F.	≤ 2倍初始標準	I.R.	Ri ≥ 2000MΩ 或 Ri * C <sub>r</sub> ≥ 50S	<p>※在上限溫度下施加 1.5 倍的額定工作電壓 1000 ± 12 小時，充放電電流不超過 50mA。將其移動到室溫條件下恢復放置 48 ± 2 小時，進行測量。</p>															
外觀	無缺陷或異常																									
電容量變化率	在 ± 30% 範圍內																									
D.F.	≤ 2倍初始標準																									
I.R.	Ri ≥ 2000MΩ 或 Ri * C <sub>r</sub> ≥ 50S																									

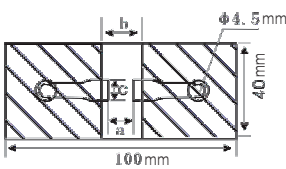
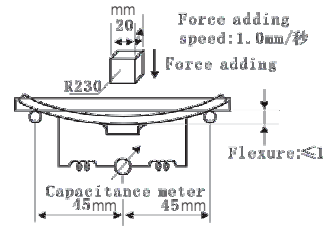
Number	Item	Standard		Test Method																						
13	Bending Resistance	Cap. Change ratio : within $\pm 10\%$		  <table border="1" data-bbox="853 627 1204 772"> <thead> <tr> <th rowspan="2">L×W (mm)</th> <th colspan="4">Dimension</th> </tr> <tr> <th>a</th> <th>b</th> <th>c</th> <th>d</th> </tr> </thead> <tbody> <tr> <td>4.5×2.0</td> <td>3.5</td> <td>7.0</td> <td>2.4</td> <td rowspan="3">1.0</td> </tr> <tr> <td>4.5×3.2</td> <td>3.5</td> <td>7.0</td> <td>3.7</td> </tr> <tr> <td>5.7×6.3</td> <td>4.5</td> <td>8.0</td> <td>5.6</td> </tr> </tbody> </table>	L×W (mm)	Dimension				a	b	c	d	4.5×2.0	3.5	7.0	2.4	1.0	4.5×3.2	3.5	7.0	3.7	5.7×6.3	4.5	8.0	5.6
L×W (mm)	Dimension																									
	a	b	c	d																						
4.5×2.0	3.5	7.0	2.4	1.0																						
4.5×3.2	3.5	7.0	3.7																							
5.7×6.3	4.5	8.0	5.6																							
14	Temperature Cycle	Appearance	No defects or abnormalities	<table border="1" data-bbox="790 840 1428 1008"> <thead> <tr> <th>Stage</th> <th>Temperature (°C)</th> <th>Time (min.)</th> </tr> </thead> <tbody> <tr> <td>1</td> <td>Min. Operating Temperature <math>\pm 3</math></td> <td>30 <math>\pm</math> 3</td> </tr> <tr> <td>2</td> <td>Room Temperature</td> <td>2—3</td> </tr> <tr> <td>3</td> <td>Max. Operating Temperature 2</td> <td>30 <math>\pm</math> 3</td> </tr> <tr> <td>4</td> <td>Room Temperature</td> <td>2—3</td> </tr> </tbody> </table>	Stage	Temperature (°C)	Time (min.)	1	Min. Operating Temperature $\pm 3$	30 $\pm$ 3	2	Room Temperature	2—3	3	Max. Operating Temperature 2	30 $\pm$ 3	4	Room Temperature	2—3							
Stage	Temperature (°C)	Time (min.)																								
1	Min. Operating Temperature $\pm 3$	30 $\pm$ 3																								
2	Room Temperature	2—3																								
3	Max. Operating Temperature 2	30 $\pm$ 3																								
4	Room Temperature	2—3																								
	Cap. Change ratio	Within $\pm 20\%$																								
	D.F.	Same as original spec.																								
	I.R.	Same as original spec.																								
15	Humidity Steady State	Appearance	No defects or abnormalities	<p>※Set the capacitor for 500+24/-0 hours at the condition of 40 <math>\pm</math> 2°C and 90-95% humidity. Then remove and set it for 24 <math>\pm</math> 2 hours at room temperature, then measure.</p>																						
	Cap. Change ratio	within $\pm 30\%$																								
	D.F.	Not more than twice of initial value																								
	I.R.	$R_i \geq 1000M \Omega$ or $R_i \cdot C_R \geq 25S$																								
16	Life Test	Appearance	No defects or abnormalities	<p>※Apply 1.5 times rated voltage to the capacitor for 1000 <math>\pm</math> 12 hours at the upper temperature limits, the charging current should be less than 50mA. Remove and set it for 24 <math>\pm</math> 2 hours at room temperature, then measure.</p>																						
	Cap. Change ratio	within $\pm 30\%$																								
	D.F.	Not more than twice of initial value																								
	I.R.	$R_i \geq 2000M \Omega$ or $R_i \cdot C_R \geq 50S$																								

### ■ 封裝型中高壓片容

封裝型中高壓片容是在常規中高壓片容的基礎,封裝樹脂型包封層。該包封層有效地避免了高壓表面飛弧的產生,防潮性好。

#### ● 特性

- \* 具有高的工作電壓。
- \* 優良的焊接性和耐焊性,適用於回流焊。

#### ● 應用

- \* 應用於環境較苛刻,工作電壓高的電子線路。

#### ● 產品規格型號表示方法

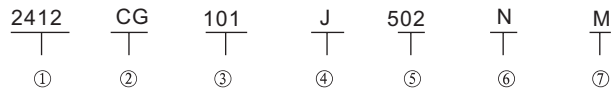

① 尺寸		
型號	英制	公制
2412	0.24 × 0.12	6.00 × 3.20

② 介質種類	
代碼	介質材料
CG	COG或NPO
B	X7R

③ 標稱電容量(PF)	
表示方式	實際值
100	$10 \times 10^0$
101	$10 \times 10^1$

④ 誤差級別	
代碼	誤差
J	± 5%
K	± 10%

⑤ 工作電壓	
表示方法	額定電壓
402	4000V
502	5000V

⑥ 端頭類別	
表示方法	端頭材料
S	純銀端頭
C	純銅端頭
N	三層電鍍端頭 (銀或銅層/鎳層/錫層)

⑦ 包裝方式	
表示方法	包裝
M	樹脂包封/ 可焊貼裝

#### ● 外形尺寸

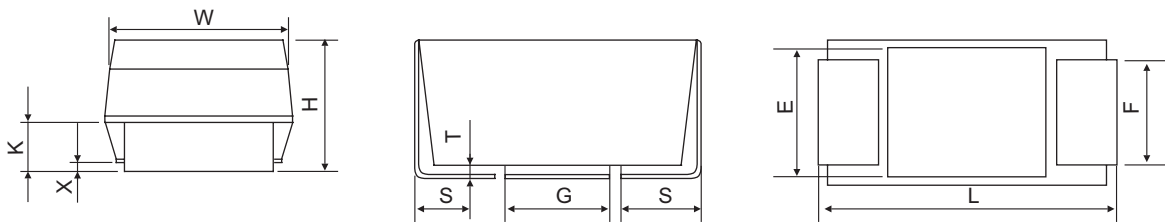

單位: mm

L	W	H	K	F	S	X	T	G	E
6.0 ± 0.2	3.2 ± 0.2	2.5 ± 0.2	1.4	2.2	1.3	0.10 ± 0.10	0.13	3.0	3.0

#### ● 容量範圍

額定工作電壓	電容量範圍(PF)	
	NPO	X7R
4000V	0.5 ~ 470	150 ~ 1000
5000V	0.5 ~ 330	150 ~ 1000

## ■ Envelopment type middle/high voltage MLCC

Envelopment tupe middle/high voltage MLCC is made by enveloping a resin envelopment based on normal middle/high boltage MLCC.The envelopment layer can prevent the high voltage flash over problems and have good moistureproof property.

### • Features

- \* High operating voltage.
- \* Good solder ability and soldering resistance properties,suitable for re-flow soldering.

### \* Application

Suitable for the circuits where have rigorous working environment and high operating voltage.

### \* Part number expressions

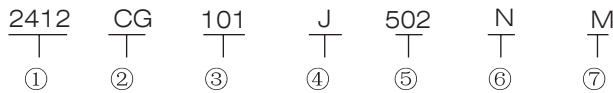

①Dimensions		
Type	british (Inch)	metric (mm)
2412	0.24×0.12	6.00×3.20

②Dielectric Type	
Code	Dielectric Material
CG	COG or NPO
B	X7R

③Normal Capacitance	
Expression Method	Actual Value
100	$10 \times 10^0$
101	$10 \times 10^1$

④Capacitance Tolerance	
Code	Tolerance
J	±5%
K	±10%

⑤Rated Voltage	
Expression Method	Actual Value
402	4000V
502	5000V

⑥Termination Type	
Expression Method	Termination
S	Pure Silver
C	Pure Copper
N	Three Layers Plating Terminal (Silver or Copper layer/ Nickel layer /Tin layer)

⑦Package Method	
Expression Method	Packaging
M	Bulk Plastic Box Packaging

### \* Outside dimensions

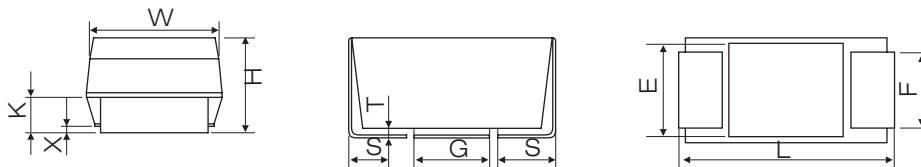

Unit:mm

L	W	H	K	F	S	X	T	G	E
6.0±0.2	3.2±0.2	2.5±0.2	1.4	2.2	1.3	0.10±0.10	0.13	3.0	3.0

### \* capacitance range

Work Voltage dielectric	Capacitor range(PF)	
	NPO	X7R
4000V	0.5~470	150~1000
5000V	0.5~330	150~1000



# 多層片式陶瓷電容器

## MULTILAYER CHIP CERAMIC CAPACITOR

### ■ 大容量片容

大容量片容分為X5R和Y5V片容。

#### ● 特性

- \* 電容量較大,比容大。
- \* 疊層獨石結構,具有高可靠性。
- \* 優良的焊接性和耐焊性,適用於回流焊。

#### ● 應用

- \* 應用於濾波、旁路電路。

#### ● 產品規格型號表示方法

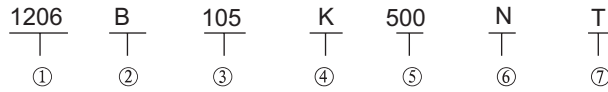

① 尺寸		
型號	英制(英寸)	公制(毫米)
0402	0.04 × 0.02	1.00 × 0.50
0603	0.06 × 0.03	1.60 × 0.80
0805	0.08 × 0.05	2.00 × 1.25
1206	0.12 × 0.06	3.20 × 1.60
1210	0.12 × 0.10	3.20 × 2.50
1812	0.18 × 0.12	4.50 × 3.20

② 介質種類	
代碼	介質材料
X	X5R
F	Y5V

③ 標稱電容量(PF)	
表示方式	實際值
100	$10 \times 10^0$
101	$10 \times 10^1$
102	$10 \times 10^2$

④ 誤差級別	
代碼	誤差
J	± 5%
K	± 10%

⑤ 工作電壓	
表示方法	額定電壓
6R3	6.3V
500	50V
101	100V

⑥ 端頭類別	
表示方法	端頭材料
S	純銀端頭
C	純銅端頭
N	三層電鍍端頭 (銀或銅層/鎳層/錫層)

⑦ 包裝方式	
表示方法	包裝
無標記	袋裝散包裝
T	編帶包裝
B	塑料盒散包裝

#### ● 外形尺寸

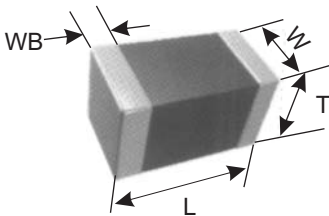

規格型號		尺寸 (mm)			
英制表示	公制表示	L	W	T	WB
0402	1005	1.00 ± 0.05	0.50 ± 0.50	0.50 ± 0.50	0.25 ± 0.10
0603	1608	1.60 ± 0.10	0.80 ± 0.10	0.80 ± 0.10	0.30 ± 0.10
0805	2012	2.00 ± 0.20	1.25 ± 0.20	0.80 ± 0.20 1.00 ± 0.20 1.25 ± 0.20	0.50 ± 0.20
1206	3216	3.20 ± 0.30	1.60 ± 0.20	0.80 ± 0.20 1.00 ± 0.20 1.25 ± 0.20	0.60 ± 0.30
1210	3225	3.20 ± 0.30	2.50 ± 0.20	≤ 2.00	0.50 ± 0.25
1812	4532	4.50 ± 0.40	3.20 ± 0.30	≤ 2.50	0.50 ± 0.25

## High layer MLCC

Big Capacitance MLCC including X7R and Y5V MLCC.

### Features

- \* Capacitance is big, unit capacitance is big.
- \* It has multi-layer monolithic structure, has high reliability.
- \* Good solderability and solder resistance, suitable for reflow soldering.

### Application

It is suitable for filter and bypassing circuits.

### Product Part Number Expression

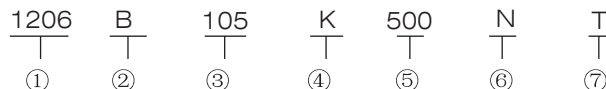

①Dimensions		
Type	British (inch)	Metric (mm)
0402	0.04 × 0.02	1.00 × 0.50
0603	0.06 × 0.03	1.60 × 0.80
0805	0.08 × 0.05	2.00 × 1.25
1206	0.12 × 0.06	3.20 × 1.60
1210	0.12 × 0.10	3.20 × 2.50
1812	0.18 × 0.12	4.50 × 3.20

②Dielectric Type	
Code	Dielectric Material
X	X7R
F	Y5V

③Normal Capacitance(PF)	
Expression Method	Actual Value
100	10 × 10 <sup>0</sup>
101	10 × 10 <sup>1</sup>
102	10 × 10 <sup>2</sup>

④Capacitance Tolerance	
Code	Tolerance
J	±5%
K	±10%

⑤Rated Voltage	
Expression Method	Actual Value
6R3	6.3V
500	50V
101	100V

⑥Termination Type	
Expression Method	Termination
S	Pure Silver
C	Pure Copper
N	Three Layers Plating Terminal (Silver or Copper layer/ Nickel layer /Tin layer)

⑦Package Method	
Expression Method	Packaging
No Mark	Bulk Packaging in a Bag
T	Taping Packaging
B	Bulk Plastic Box Packaging

### Outside Dimension

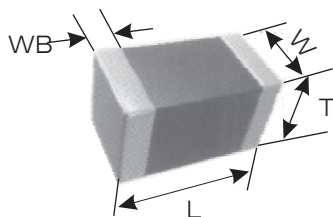

Type		Dimension (mm)			
British expression	Metric expression	L	W	T	WB
0402	1005	1.00 ± 0.05	0.50 ± 0.50	0.50 ± 0.50	0.25 ± 0.10
0603	1608	1.60 ± 0.10	0.80 ± 0.10	0.80 ± 0.10	0.30 ± 0.10
0805	2012	2.00 ± 0.20	1.25 ± 0.20	0.80 ± 0.20 1.00 ± 0.20 1.25 ± 0.20	0.50 ± 0.20
1206	3216	3.20 ± 0.30	1.60 ± 0.20	0.80 ± 0.20 1.00 ± 0.20 1.25 ± 0.20	0.60 ± 0.30
1210	3225	3.20 ± 0.30	2.50 ± 0.20	≤ 2.00	0.50 ± 0.25
1812	4532	4.50 ± 0.40	3.20 ± 0.30	≤ 2.50	0.50 ± 0.25

# 多層片式陶瓷電容器

## MULTILAYER CHIP CERAMIC CAPACITOR

- 電容量範圍

項目	大容量X5R片容																			
	0603				0805				1206				1210				1812			
尺寸																				
工作電壓	6.3V	10V	16V	25V	6.3V	10V	16V	25V	6.3V	10V	16V	25V	6.3V	10V	16V	25V	6.3V	10V	16V	25V
電容量																				
100nF																				
220nF																				
330nF																				
470nF	■	■	■	■																
560nF	■	■	■	■																
680nF																				
1 μF					■	■	■	■												
2.2 μF				■	■	■	■	■	■	■	■	■								
3.3 μF																				
4.7 μF			■	■									■	■	■	■				
10 μF	■	■			■	■	■	■	■	■	■	■					■	■	■	■
22 μF																	■	■	■	■
33 μF																				
47 μF													■	■	■	■				
100 μF																				

項目	大容量Y5V片容																			
	0603				0805				1206				1210				1812			
尺寸																				
工作電壓	6.3V	10V	16V	25V	6.3V	10V	16V	25V	6.3V	10V	16V	25V	6.3V	10V	16V	25V	6.3V	10V	16V	25V
電容量																				
1 μF	■	■	■	■																
2.2 μF			■	■																
3.3 μF																				
4.7 μF																				
10 μF	■	■																		
22 μF																				
33 μF																				
47 μF																				
56 μF																				
68 μF																				
82 μF																				
100 μF																				

• Capacitance Range

Item	X5R Big Capacitance MLCC																			
Dimension	0603				0805				1206				1210				1812			
Rated Volatage	6.3V	10V	16V	25V	6.3V	10V	16V	25V	6.3V	10V	16V	25V	6.3V	10V	16V	25V	6.3V	10V	16V	25V
Capacitance																				
100nF																				
220nF																				
330nF																				
470nF	■	■	■	■																
560nF	■	■	■	■																
680nF																				
1 μF	■	■	■	■	■	■	■	■	■	■	■	■								
2.2 μF	■	■	■	■	■	■	■	■	■	■	■	■	■	■	■	■				
3.3 μF																				
4.7 μF																				
10 μF	■	■	■	■	■	■	■	■	■	■	■	■	■	■	■	■	■	■	■	■
22 μF																				
33 μF																				
47 μF																				
100 μF																				

Item	Y5V Big Capacitance MLCC																			
Size	0603				0805				1206				1210				1812			
Rated Volatage	6.3V	10V	16V	25V	6.3V	10V	16V	25V	6.3V	10V	16V	25V	6.3V	10V	16V	25V	6.3V	10V	16V	25V
Capacitance																				
1 μF	■	■	■	■	■	■	■	■	■	■	■	■	■	■	■	■				
2.2 μF	■	■	■	■	■	■	■	■	■	■	■	■	■	■	■	■	■	■	■	■
3.3 μF																				
4.7 μF	■	■	■	■	■	■	■	■	■	■	■	■	■	■	■	■	■	■	■	■
10 μF	■	■	■	■	■	■	■	■	■	■	■	■	■	■	■	■	■	■	■	■
22 μF																				
33 μF																				
47 μF																				
56 μF																				
68 μF																				
82 μF																				
100 μF																				

## 多層片式陶瓷電容器

### MULTILAYER CHIP CERAMIC CAPACITOR

#### ■ 0201片容

##### ● 特性

- \* 小型芯片尺寸(長×寬×厚: 0.6×0.3×0.3mm) ;
- \* 電容寄生電感小;
- \* 適合回流焊接;
- \* 適合微型微波組件、便攜式機器及高頻電路。

##### ● 應用

- \* 微型微波組件用;
- \* 便攜式機器用;
- \* 高頻電路用。

##### ● 產品規格型號表示方法

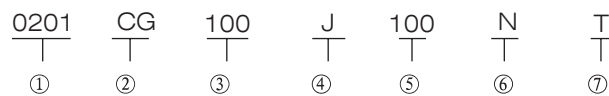

① 尺寸		
型號	英制(英寸)	公制(毫米)
0201	0.02 × 0.01	0.50 × 0.25

② 介質種類	
代碼	介質材料
CG	COG或NPO
B	X7R
F	Y5V

③ 標稱電容量(PF)	
表示方式	實際值
100	$10 \times 10^0$
101	$10 \times 10^1$
102	$10 \times 10^2$

④ 誤差級別	
代碼	誤差
J	±5%
K	±10%
M	±20%

⑤ 工作電壓	
表示方法	實際電壓
6R3	6.3V
100	10V
250	25V

⑥ 端頭類別	
表示方法	端頭材料
S	純銀端頭
C	純銅端頭
N	三層電鍍端頭 (銀或銅層/鎳層/錫層)

⑦ 包裝方式	
表示方法	包裝
無標記	袋裝散包裝
T	編帶包裝
B	塑料盒散包裝

##### ● 外形尺寸

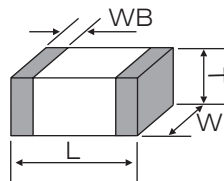

規格型號		尺寸( mm )			
英制表示	公制表示	L	W	T	WB
0201	0603	$0.60 \pm 0.03$	$0.30 \pm 0.03$	$0.30 \pm 0.03$	$\geq 0.10, \leq 0.20$

## 0201 MLCC

### • Features

- \* Small chip size .
- \* Terminations are made of metal highly resistant to migration.
- \* This type is suited to only reflow soldering.
- \* Suited to miniature micro wave module, portable equipment and high-frequency circuits.

### • Applications

- \* Miniature micro wave module.
- \* Portable equipment;
- \* High-frequency circuits.

### • Product Part Number Expression

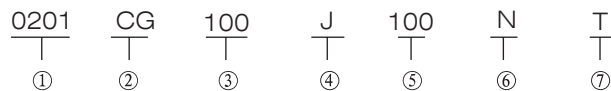

①Dimensions		
Type	British (Inch)	Metric (mm)
0201	0.02 × 0.01	0.5 × 0.25

②Dielectric Type	
Code	Dielectric
CG	COG or NPO
B	X7R
F	Y5V

③Normal Capacitance	
Expression Method	Actual Value
100	10

④Capacitance Tolerance	
Code	Tolerance
J	± 5%
K	± 10%
M	± 20%

⑤Rated Voltage	
Expression Method	Actual Value
6R3	6.3
100	10V
250	25V

⑥Termination Type	
Expression Method	Termination
S	Pure Silver
C	Pure Copper
N	Three Layers Plating Terminal (Silver or Copper layer/ Nickel layer /Tin layer)

⑦Package Method	
Expression Method	Packaging
No Mark	Bulk Packaging in a Bag
T	Taping Packaging
B	Bulk Plastic Box Packaging

### • Outside Dimension

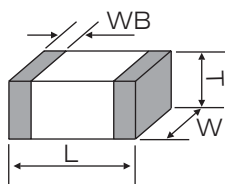

Type		Dimension( mm)			
British expression	Metric expression	L	W	T	WB
0201	0603	0.60 ± 0.03	0.30 ± 0.03	0.3 ± 0.03	0.1 ~ 0.2

# 多層片式陶瓷電容器

## MULTILAYER CHIP CERAMIC CAPACITOR

- 電容量範圍

項目	0201電容					
尺寸	COG	X7R	X5R		Y5V	
工作電壓	50V	10V/16V/25V	6.3V	10V	6.3V/10V	
電容量						電容量
0.5PF						0.5PF
1PF						1PF
2PF						2PF
4PF						4PF
5PF						5PF
10PF						10PF
20PF						20PF
33PF						33PF
47PF						47PF
100PF						100PF
220PF						220PF
330PF						330PF
470PF						470PF
680PF						680PF
1000PF						1000PF
1.5nF						1.5nF
2.2nF						2.2nF
3.3nF						3.3nF
4.7nF						4.7nF
6.8nF						6.8nF
10nF						10nF
15nF						15nF
33nF						33nF
47nF						47nF
100nF						100nF
470nF						470nF
1000nF						1000nF

• Capacitance Range

Item	0201 MLCC					Capacitance
	Dielectric Type	COG	X7R	X5R		
Rated Volatage	50V	6.3V10V/16V	6.3V	10V	10V	
Capacitance						Capacitance
0.5PF						0.5PF
1PF						1PF
2PF						2PF
4PF						4PF
5PF						5PF
10PF						10PF
20PF						20PF
33PF						33PF
47PF						47PF
100PF						100PF
220PF						220PF
330PF						330PF
470PF						470PF
680PF						680PF
1000PF						1000PF
1.5nF						1.5nF
2.2nF						2.2nF
3.3nF						3.3nF
4.7nF						4.7nF
6.8nF						6.8nF
10nF						10nF
15nF						15nF
33nF						33nF
47nF						47nF
100nF						100nF
470nF						470nF
1000nF						1000nF



## 多層片式陶瓷電容器

### MULTILAYER CHIP CERAMIC CAPACITOR

#### ■ 超小型片容

##### ● 特性

- \* 電容寄生電感小;
- \* 適合回流焊接;
- \* 小型化(尺寸 $0.4 \times 0.2 \times 0.2\text{mm}$ )
- \* 適合微型微波組件、便携式機器及高頻電路。

##### ● 應用

- \* 功率放大器 (PA) ;
- \* 壓控振盪器 (VCO) ;
- \* 高頻模塊。

##### ● 產品規格型號表示方法

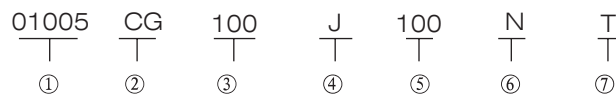

① 尺寸		
型號	英制(英寸)	公制(毫米)
01005	$0.01 \times 0.005$	$0.40 \times 0.20$

② 介質種類	
代碼	介質材料
CG	COG或NPO
B	X7R

③ 標稱電容量(PF)	
表示方式	實際值
100	$10 \times 10^0$
103	$10 \times 10^3$

④ 誤差級別	
代碼	誤差
J	$\pm 5\%$
K	$\pm 10\%$

⑤ 工作電壓	
表示方法	實際電壓
6R3	6.3V
100	10V
160	16V

⑥ 端頭類別	
表示方法	端頭材料
S	純銀端頭
C	純銅端頭
N	三層電鍍端頭 (銀或銅層/鎳層/錫層)

⑦ 包裝方式	
表示方法	包裝
無標記	袋裝散包裝
T	編帶包裝
B	塑料盒散包裝

##### ● 外形尺寸

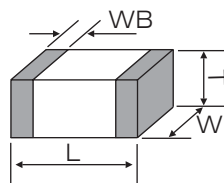

規格型號		尺寸( mm )			
英制表示	公制表示	L	W	T	WB
01005	0402	$0.40 \pm 0.02$	$0.20 \pm 0.02$	$0.20 \pm 0.02$	0.07~0.14

## ■ Ultra-small size, the word's smallest

### • Features

- \* Terminations are made of metal highly resistant to migration;
- \* Suited to only reflow soldering;
- \* For equipment miniaturization (dimension  $0.4 \times 0.2 \times 0.2\text{mm}$ );
- \* Suited to miniature micro wave module, portable equipment and high-frequency circuits.

### • Application

- \* For PAs, VCOs and high frequency modules.

### • Product Part Number Expression

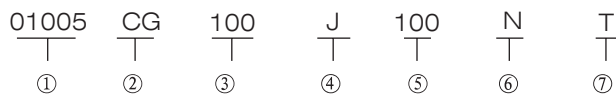

① Dimensions		
Type	British (Inch)	Metric (mm)
01005	$0.01 \times 0.005$	$0.40 \times 0.20$

② Dielectric Type	
Code	Dielectric
CG	COG or NPO
B	X7R

③ Normal Capacitance	
Expression Method	Actual Value
100	$10 \times 10^0$
103	$10 \times 10^3$

④ Capacitance Tolerance	
Code	Tolerance
J	$\pm 5\%$
K	$\pm 10\%$

⑤ Rated Voltage	
Expression Method	Actual Value
6R3	6.3
100	10V
160	16V

⑥ Termination Type	
Expression Method	Termination
S	Pure Silver
C	Pure Copper
N	Three Layers Plating Terminal (Silver or Copper layer/ Nickel layer /Tin layer)

⑦ Package Method	
Expression Method	Packaging
No Mark	Bulk Packaging in a Bag
T	Taping Packaging
B	Bulk Plastic Box Packaging

### • Outside Dimension

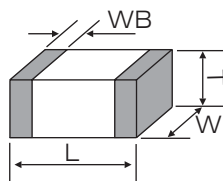

Type		Dimension (mm)			
British expression	Metric expression	L	W	T	WB
01005	0402	$0.40 \pm 0.02$	$0.20 \pm 0.02$	$0.20 \pm 0.02$	$0.07 \sim 0.14$

# 多層片式陶瓷電容器

## MULTILAYER CHIP CERAMIC CAPACITOR

項目	超小尺寸多層片式陶瓷電容器										
尺寸	01005		0201								
介質種類	COG	X7R	COG	X7R				Y5V			
工作電壓	10V	16V	25V	6.3V	10V	16V	25V	6.3V	16V		
電容量											電容量
0.5PF											0.5PF
10PF											10PF
20PF											20PF
47PF											47PF
100PF											100PF
1nF											1nF
1.5nF											1.5nF
2.2nF											2.2nF
3.3nF											3.3nF
4.7nF											4.7nF
6.8nF											6.8nF
10nF											10nF
15nF											15nF
22nF											22nF
33nF											33nF
47nF											47nF
68nF											68nF
100nF											100nF

Item	Ultra-small size Multilayer Chip Ceramic Capacitor										
Dimension	01005		0201								
Dielectric Type	COG	X7R	COG	X7R				Y5V			
Rated Volatage	10V	16V	25V	6.3V	10V	16V	25V	6.3V	16V		
Capacitance										Capacitance	
0.5PF											0.5PF
10PF											10PF
20PF											20PF
47PF											47PF
100PF											100PF
1nF											1nF
1.5nF											1.5nF
2.2nF											2.2nF
3.3nF											3.3nF
4.7nF											4.7nF
6.8nF											6.8nF
10nF											10nF
15nF											15nF
22nF											22nF
33nF											33nF
47nF											47nF
68nF											68nF
100nF											100nF

# 多層片式陶瓷電容器

## MULTILAYER CHIP CERAMIC CAPACITOR

### ■ 薄型電容器

#### ● 特征

- \* 超薄尺寸,厚度為0.3mm,0.4mm,0.5mm;
- \* 適合波峰焊及回流焊接;
- \* 非常適合小型電子產品生產及安裝在IC下。

#### ● 應用

- \* IC卡或IC底座。

#### \* 產品規格型號表示方法

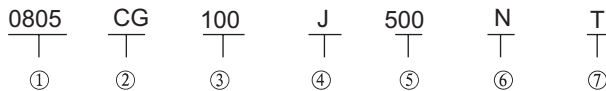

① 尺寸		
型號	英制(英寸)	公制(毫米)
0805	0.08 × 0.05	2.00 × 1.25
1206	0.12 × 0.06	3.20 × 1.60

② 介質種類	
代碼	介質材料
CG	COG或NPO
B	X7R

③ 標稱電容量(PF)	
表示方式	實際值
100	$10 \times 10^0$
101	$10 \times 10^1$
102	$10 \times 10^2$

④ 誤差級別	
代碼	誤差
J	± 5%
K	± 10%

⑤ 工作電壓	
表示方法	實際電壓
6R3	6.3V
100	10V
250	25V
500	50V

⑥ 端頭類別	
表示方法	端頭材料
S	純銀端頭
C	純銅端頭
N	三層電鍍端頭 (銀或銅層/鎳層/錫層)

⑦ 包裝方式	
表示方法	包裝
無標記	袋裝散包裝
T	編帶包裝

#### ● 外形尺寸

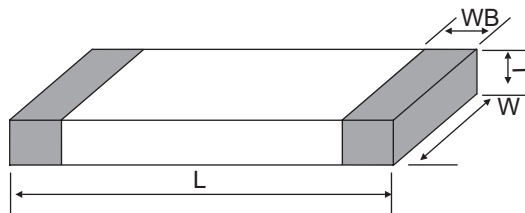

規格型號		尺寸 (mm)			
英制表示	公制表示	L	W	T	WB
0805	2012	$2.00 \pm 0.20$	$1.25 \pm 0.20$	$0.30 \pm 0.10$	$0.50 \pm 0.25$
				$0.40 \pm 0.10$	
				$0.50 \pm 0.10$	
1206	3216	$3.20 \pm 0.30$	$1.60 \pm 0.20$	$0.30 \pm 0.10$	$0.50 \pm 0.25$
				$0.40 \pm 0.10$	
				$0.50 \pm 0.10$	

## Thin Type MLCC

- Features:

- \* Ultra-thin size, thickness is 0.3mm, 0.4mm, 0.5mm.
- \* This type is suited to flow and reflow soldering.
- \* Its thin package makes this series ideally suited for the production of small electronic products and for mounting underneath ICs.

- Applications:

- \* IC cards or IC base

- Product Part Number Expression

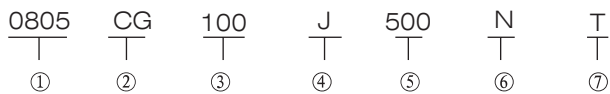

①Dimensions		
Type	British (Inch)	Metric (mm)
0805	0.08 × 0.05	2.0 × 1.25
1206	0.12 × 0.06	3.2 × 1.60

②Dielectric Type	
Code	Dielectric
CG	COG or NPO
B	X7R

③Normal Capacitance(PF)	
Expression Method	Actual Value
100	10 × 10 <sup>0</sup>
101	10 × 10 <sup>1</sup>
102	10 × 10 <sup>2</sup>

④Capacitance Tolerance	
Code	Tolerance
J	± 5%
K	± 10%

⑤Rated Voltage	
Expression Method	Actual Value
6R3	6.3V
100	10V
250	25V
500	50V

⑥Termination Type	
Expression Method	Termination
S	Pure Silver
C	Pure Copper
N	Three Layers Plating Terminal (Silver or Copper layer/ Nickel layer /Tin layer)

⑦Package Method	
Expression Method	Packaging
T	Taping Packaging

- Outside Dimension

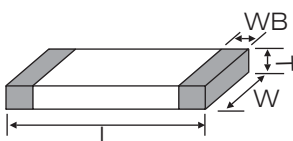

Type		Dimension(mm)			
British expression	Metric expression	L	W	T	WB
0805	2012	2.00 ± 0.20	1.25 ± 0.20	0.30 ± 0.10 0.40 ± 0.10 0.50 ± 0.10	0.50 ± 0.25
1206	3216	3.20 ± 0.30	1.60 ± 0.20	0.30 ± 0.10 0.40 ± 0.10 0.50 ± 0.10	0.50 ± 0.25

# 多層片式陶瓷電容器

## MULTILAYER CHIP CERAMIC CAPACITOR

### ■ 電容量範圍

項目	0805型薄形電容器						1206型薄形電容器				
介質種類	COG			X7R			COG		X7R		
厚度	0.3mm	0.4mm	0.5mm	0.3mm	0.4mm	0.5mm	0.4mm	0.5mm	0.4mm	0.5mm	
電容量											電容量
0.5PF											0.5PF
1PF											1PF
5PF											5PF
10PF											10PF
15PF											15PF
22PF											22PF
33PF											33PF
47PF											47PF
68PF											68PF
100PF											100PF
150PF											150PF
220PF											220PF
330PF											330PF
470PF											470PF
1000PF											1000PF
2.2nF											2.2nF
3.3nF											3.3nF
4.7nF											4.7nF
6.8nF											6.8nF
10nF											10nF
22nF											22nF
33nF											33nF
47nF											47nF
100nF											100nF

• Capacitance Range

Item	0805 Thin MLCC						1206 Thin MLCC				
Dielectric Type	COG			X7R			COG		X7R		
Thickness	0.3mm	0.4mm	0.5mm	0.3mm	0.4mm	0.5mm	0.4mm	0.5mm	0.4mm	0.5mm	
Capacitance											Capacitance
0.5PF											0.5PF
1PF											1PF
5PF											5PF
10PF											10PF
15PF											15PF
22PF											22PF
33PF											33PF
47PF											47PF
68PF											68PF
100PF											100PF
150PF											150PF
220PF											220PF
330PF											330PF
470PF											470PF
1000PF											1000PF
2.2nF											2.2nF
3.3nF											3.3nF
4.7nF											4.7nF
6.8nF											6.8nF
10nF											10nF
22nF											22nF
33nF											33nF
47nF											47nF
100nF											100nF



### ■ 片式排容

片式排容是由若干個電容并排列而成的電容陣列，應用于對元器件空間要求嚴格的PCB，如手提電腦、PDA、手提電話等，特別適用于輸入、輸出接口電路。

#### ● 特性

- \* 高密度安裝，節省安裝空間。
- \* 節省安裝成本。
- \* 適合回流焊接。

#### ● 應用

- \* 適用于對元器件空間要求嚴格的PCB，如手提電腦、PDA、無繩電話。
- \* 特別適用于輸入、輸出接口電路。

#### ● 產品規格型號表示方法

$\frac{612}{\text{①}}$      $\frac{4}{\text{②}}$      $\frac{B}{\text{③}}$      $\frac{102}{\text{④}}$      $\frac{K}{\text{⑤}}$      $\frac{500}{\text{⑥}}$      $\frac{N}{\text{⑦}}$      $\frac{T}{\text{⑧}}$

① 尺寸規格	
612	0612
508	0508
504	0504

② 內置單元數目	
4	4個內置單元
2	2個內置單元

③ 介質種類	
代碼	介質材料
CG	NPO/COG
B	X7R
F	Y5V

④ 標稱電容量(PF)	
表示方式	實際值
100	$10 \times 10^0$
101	$10 \times 10^1$
102	$10 \times 10^2$

⑤ 誤差級別	
代碼	誤差
C	$\pm 0.25\text{PF}$
D	$\pm 0.50\text{PF}$
G	$\pm 2\%$
J	$\pm 5\%$
K	$\pm 10\%$
M	$\pm 20\%$

⑦ 端頭類別	
表示方法	端頭材料
S	純銀端頭
C	純銅端頭
N	三層電鍍端頭 (銀或銅層/鎳層/錫層)

⑥ 工作電壓	
表示方法	實際電壓
6R3	6.3V
500	50V
101	100V

⑧ 包裝方式	
表示方法	包裝
無標記	袋裝散包裝
T	編帶包裝
B	塑料盒散包裝

## Capacitor Arrays

Capacitor Arrays is formed with several chips paratactic inside, applied to the PCB that has strict space requirement about the parts, such as portable computer, PDA, portable telephone, etc., Special suitable for input/output circuits.

### • Features

- \* Has high density mounting so that save the mounting space
- \* Can save mounting cost .
- \* Suitable for reflow soldering.

### • Applications

- \* Suitable for the PCB that has strict parts space requirement such as portable computer, PDA and wireless telephone.
- \* Special suitable for input/output circuits.

### • Product Part Number Expression:

$\frac{612}{\textcircled{1}}$      $\frac{4}{\textcircled{2}}$      $\frac{B}{\textcircled{3}}$      $\frac{102}{\textcircled{4}}$      $\frac{K}{\textcircled{5}}$      $\frac{500}{\textcircled{6}}$      $\frac{N}{\textcircled{7}}$      $\frac{T}{\textcircled{8}}$

①Dimensions	
612	0612
508	0508
504	0504

②Elements Inside	
4	Four elements inside
2	Two elements inside

③Dielectric Type	
Code	Dielectric Material
CG	COG or NPO
B	X7R
F	Y5V

④Normal Capacitance(PF)	
Expression Method	Actual Value
100	$10 \times 10^0$
101	$10 \times 10^1$
102	$10 \times 10^2$

⑤Capacitance Tolerance	
CODE	TOLERANCE
J	± 5%
G	± 2%
C	± 0.25PF
K	± 10%
D	± 0.50PF
M	± 20%

⑥Rated Voltage	
Expression Method	Actual Value
6R3	6.3V
500	50V
101	100V

⑦Termination Type	
Expression Method	Termination Material
S	Pure Silver
C	Pure Copper
N	Three Layers Plating Terminal (Silver or Copper layer/ Nickel layer /Tin layer)

⑧Package Method	
Expression Method	Packaging
T	Taping Packaging
B	Bulk Plastic Box Packaging

# 多層片式陶瓷電容器

## MULTILAYER CHIP CERAMIC CAPACITOR

### • 外形尺寸

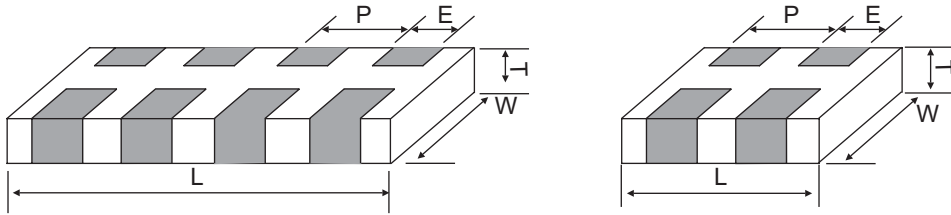

規格型號	尺寸 (mm)				
	L	W	T	P	E
0805二聯體	2.00 ± 0.20	1.25 ± 0.20 1.00 ± 0.10	0.80 ± 0.10	1.00 ± 0.10	0.50 ± 0.05
0805四聯體	2.00 ± 0.20	1.25 ± 0.20 1.00 ± 0.10	0.80 ± 0.10	0.50 ± 0.05	0.25 ± 0.05
1206四聯體	3.20 ± 0.30	1.60 ± 0.20 1.00 ± 0.10	0.80 ± 0.10	0.80 ± 0.10	0.40 ± 0.10

### • 電容量範圍

項目	0603 × 4									電容量
	COG			X7R			Y5V			
尺寸										
工作電壓	16V	25V	50V	16V	25V	50V	16V	25V	50V	
電容量										電容量
0.5PF										0.5PF
5PF										5PF
10PF										10PF
15PF										15PF
20PF										20PF
22PF										22PF
33PF										33PF
47PF										47PF
100PF										100PF
150PF										150PF
220PF										220PF
330PF										330PF
470PF										470PF
1000PF										1000PF
2.2nF										2.2nF
3.3nF										3.3nF
4.7nF										4.7nF
6.8nF										6.8nF
10nF										10nF
22nF										22nF
33nF										33nF
47nF										47nF
68nF										68nF
100nF										100nF
220nF										220nF

• Outside Dimension

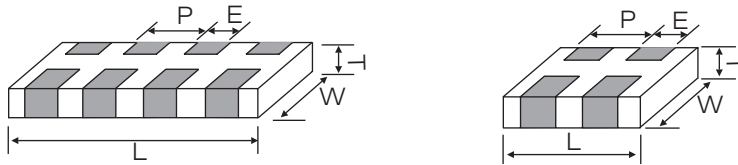

Type		Dimension( mm)			
British expression	Metric expression	L	W	T	WB
0805 two elements	2.00 ± 0.20	1.25 ± 0.20	0.80 ± 0.10 1.00 ± 0.10	1.00 ± 0.10	0.5
0805 two elements	2.00 ± 0.20	1.25 ± 0.20	0.80 ± 0.10 1.00 ± 0.10	0.50 ± 0.05	0.25 ± 0.05
1206 four elements	3.20 ± 0.30	1.60 ± 0.20	0.80 ± 0.10 1.00 ± 0.10	0.80 ± 0.10	0.40 ± 0.10

• Capacitance Range

Item	0603 × 4									Capacitance
	COG			X7R			Y5V			
	16V	25V	50V	16V	25V	50V	16V	25V	50V	
0.5PF										0.5PF
5PF										5PF
10PF										10PF
15PF										15PF
20PF										20PF
22PF										22PF
33PF										33PF
47PF										47PF
100PF										100PF
150PF										150PF
220PF										220PF
330PF										330PF
470PF										470PF
1000PF										1000PF
2.2nF										2.2nF
3.3nF										3.3nF
4.7nF										4.7nF
6.8nF										6.8nF
10nF										10nF
22nF										22nF
33nF										33nF
47nF										47nF
68nF										68nF
100nF										100nF
220nF										220nF

# 多層片式陶瓷電容器

## MULTILAYER CHIP CERAMIC CAPACITOR

項目	0502 × 4									0504 × 2								
	COG			X7R			Y5V			COG			X7R			Y5V		
	16V	25V	50V	16V	25V	50V	16V	25V	50V	16V	25V	50V	16V	25V	50V	16V	25V	50V
電容量																		
0.5PF	■	■	■							■	■	■						
5PF																		
10PF																		
15PF																		
20PF																		
22PF																		
33PF																		
47PF																		
100PF				■	■	■				■	■	■						
150PF	■	■	■															
220PF																		
330PF										■	■	■						
470PF																		
1000PF							■	■	■							■	■	■
2.2nF																		
3.3nF																		
4.7nF																		
6.8nF				■	■	■												
10nF																		
22nF							■	■	■				■	■	■			
33nF																		
47nF																		
68nF																■	■	■
100nF																		
220nF																		

Item	0502 × 4									0504 × 2								
	COG			X7R			Y5V			COG			X7R			Y5V		
	16V	25V	50V	16V	25V	50V	16V	25V	50V	16V	25V	50V	16V	25V	50V	16V	25V	50V
Capacitance																		
0.5PF	█	█	█							█	█	█						
5PF																		
10PF																		
15PF																		
20PF																		
22PF																		
33PF																		
47PF				█	█	█							█	█	█			
100PF	█	█	█	█	█	█				█	█	█	█	█	█			
150PF																		
220PF										█	█	█						
330PF																		
470PF																		
1000PF							█	█	█							█	█	█
2.2nF																		
3.3nF																		
4.7nF				█	█	█												
6.8nF																		
10nF							█	█	█				█	█	█			
22nF																		
33nF																		
47nF																		
68nF																		
100nF																		
220nF																		

### ■ 低感抗片式電容器

低感抗片式多層陶瓷電容器通過改變與端頭結合部分的長寬比,做成短而寬的產品,提高電極的導電率和導電面積,降低ESR和ESL,減少電流變化的電壓下降引起的噪聲干擾。從而使系統達到低損耗、高效率、高速運行的目的。

#### ● 特性

\* 適合回流焊接。

#### ● 應用

\* 高速微處理器;

\* 多芯片模塊 (MCM) 中心流噪聲的抑制;

\* 高速數字設備。

#### ● 產品型號規格表示方法



① 尺寸		
型號	英制(英寸)	公制(毫米)
0508	0.05 × 0.08	1.25 × 2.00
0612	0.06 × 0.12	1.60 × 3.20

② 介質種類	
代碼	介質材料
CG	COG或NPO
B	X7R
F	Y5V

③ 標稱電容量(PF)	
表示方式	實際值
0R5	0.5
1R0	1.0
102	10 × 10 <sup>2</sup>

④ 誤差級別	
代碼	誤差
J	± 5%
K	± 10%
M	± 20%

⑦ 包裝方式	
表示方法	包裝
無標記	袋裝散包裝
T	編帶包裝
B	塑料盒散包裝

⑤ 工作電壓	
表示方法	實際電壓
6R3	6.3V
500	50V
101	100V

⑥ 端頭類別	
表示方法	端頭材料
S	純銀端頭
C	純銅端頭
N	三層電鍍端頭 (銀或銅層/鎳層/錫層)

#### ● 外形尺寸

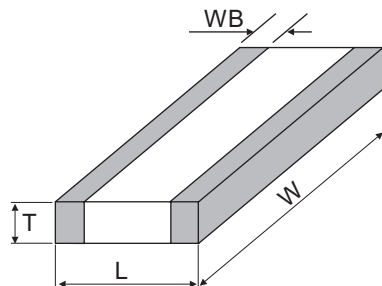

規格型號		尺寸 (mm)			
英制表示	公制表示	L	W	T	WB
0508	1220	1.20 ± 0.10	2.00 ± 0.20	0.8 ± 0.10	0.25 ± 0.10
0612	1632	1.60 ± 0.10	3.20 ± 0.20	0.8 ± 0.15	0.25 ± 0.10

## Low Inductance MLCC

Low inductance MLCC is short and wide products by change the length over width ratio of the section that connected with the termination. This can increase the conductivity and current conducting area, reduce ESR and ESL, reduce the noise disturbance due to voltage decreasing caused by current change, then make the whole system has low dissipation factor, high efficiency and high speed.

- Features

- \* Suitable for reflow soldering.

- Applications

- \* High-speed micro processor.

- \* Reduce multi chip module center current noise

- \* High speed digital equipment.

- Product Part Number Expression

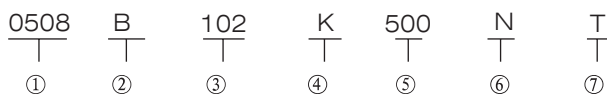

①Dimensions		
Type	British (Inch)	Metric (mm)
0805	0.08 × 0.05	2.0 × 1.25
0612	0.06 × 0.12	1.6 × 3.2

②Dielectric Type	
Code	Dielectric
CG	COG or NPO
B	X7R
F	Y5V

③Normal Capacitance(PF)	
Expression Method	Actual Value
OR5	0.5
1R0	1.0
102	10 × 10 <sup>2</sup>

④Capacitance Tolerance	
Code	Tolerance
J	± 5%
K	± 10%
M	± 20%

⑤Rated Voltage	
Expression Method	Actual Value
6R3	6.3V
250	25V
101	100V

⑥Termination Type	
Expression Method	Termination Material
S	Pure Silver
C	Pure Copper
N	Three Layers Plating Terminal (Silver or Copper layer/ Nickel layer /Tin layer)

⑦Package Method	
Expression Method	Packaging
NOMARKS	Bulk Bag Packaging
T	Taping Packaging
B	Bulk Plastic Box Packaging

- Outside Dimension

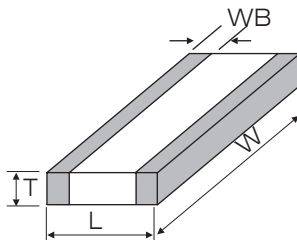

Type		Dimension( mm)			
British expression	Metric expression	L	W	T	WB
0508	1220	1.20 ± 0.10	2.00 ± 0.20	0.80 ± 0.10	0.25 ± 0.10
0612	1632	1.60 ± 0.10	3.20 ± 0.20	0.80 ± 0.15	0.25 ± 0.10



# 多層片式陶瓷電容器

## MULTILAYER CHIP CERAMIC CAPACITOR

- 電容量範圍

項目	0508低感抗片容									0612低感抗片容								
	COG			X7R			Y5V			COG			X7R			Y5V		
	16V	25V	50V	16V	25V	50V	16V	25V	50V	16V	25V	50V	16V	25V	50V	16V	25V	50V
電容量																		
0.5PF	■	■	■							■	■	■						
5PF																		
10PF																		
15PF																		
20PF																		
22PF																		
33PF																		
47PF																		
100PF				■	■	■												
150PF																		
220PF																		
330PF																		
470PF																		
1000PF							■	■	■				■	■	■			
2.2nF	■	■	■							■	■	■						
3.3nF																		
4.7nF																		
6.8nF																		
10nF																■	■	■
22nF																		
33nF																		
47nF																		
68nF																		
100nF																		
220nF																		
330nF																		
470nF																		
1 μ F																■	■	■
2.2 μ F																		

• Capacitance Range

Item	0508 Low Inductance MLCC									0612 Low Inductance MLCC									
	COG			X7R			Y5V			COG			X7R			Y5V			
	16V	25V	50V	16V	25V	50V	16V	25V	50V	16V	25V	50V	16V	25V	50V	16V	25V	50V	
Capacitance																			
0.5PF																			
5PF																			
10PF																			
15PF																			
20PF																			
22PF																			
33PF																			
47PF																			
100PF																			
150PF																			
220PF																			
330PF																			
470PF																			
1000PF																			
2.2nF																			
3.3nF																			
4.7nF																			
6.8nF																			
10nF																			
22nF																			
33nF																			
47nF																			
68nF																			
100nF																			
220nF																			
330nF																			
470nF																			
1 μ F																			
2.2 μ F																			

### ■ 片式三端陶瓷濾波電容器(EMI)

#### ● 特性

- \* 具有優良的通流特性
- \* 無極性,適合高密度的表面安裝
- \* 具有優良的濾波特性和
- \* 具有良好的吸收噪音、抑制浪涌脈衝的作用
- \* 具有良好的可焊與耐焊性能

#### ● 應用範圍

- \* 移動電話及基站
- \* 通信設備
- \* 自動化儀表和程序控制器

#### ● 汽車電子

- \* 計算機及外圍設備

#### ● 產品規格型號表示方法

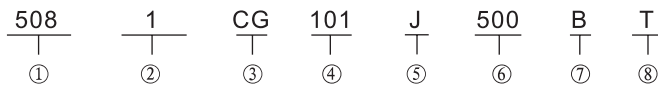

① 尺寸		
型號	英制(英寸)	公制(毫米)
508	0.05 × 0.08	1.25 × 2.00
512	0.05 × 0.12	1.25 × 3.20
618	0.06 × 0.18	1.60 × 4.50

② 代號	
1	抗電磁干擾電容器

③ 介質種類	
代碼	介質材料
CG	NPO
B	X7R
F	Y5V

④ 標稱電容量(PF)	
表示方式	實際值
102	$10 \times 10^2$
222	$22 \times 10^2$

⑤ 誤差級別	
代碼	誤差
M	±20%
S	+50%—20%

⑥ 額定電壓	
表示方法	實際電流
6R3	6.3
160	16
250	25
101	100

⑦ 額定電流	
表示方法	實際電流
B	0.3A
C	0.4A
D	1A
E	2A

⑧ 包裝方式	
表示方法	包裝
無標記	袋裝散包裝
T	編帶包裝
B	塑料盒散包裝

#### ● 外形尺寸

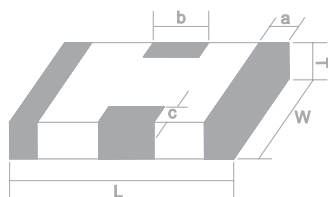

單位: mm

項目 規格	長	寬	厚	端頭厚度	第三端寬度	第三端頭厚度
508	2.00 ± 0.20	1.25 ± 0.20	0.80 ± 0.20	0.25 ± 0.10	0.60 ± 0.20	0.25 ± 0.15
512	3.20 ± 0.20	1.25 ± 0.20	0.70 ± 0.20	0.30 ± 0.20	1.10 ± 0.30	0.25 ± 0.20
618	4.50 ± 0.30	1.60 ± 0.20	1.00 ± 0.20	0.40 ± 0.30	1.50 ± 0.30	0.30 ± 0.20

## ■ Chip Three-terminals Ceramic Filter (EMI)

### • Features

- \* Has good current properties.
- \* No reverse, suitable for high-density surface-mounting.
- \* Good filter property.
- \* Good noise suppression and surge suppression.
- \* Good solderability and soldering resistance.

### • Applications:

- \* Mobile telephone and mobile base.
- \* Communication equipment.
- \* Automatization instruments and process controller.
- \* Bus circuits.
- \* Computers and outside equipment.

### • Product Part Number Expression

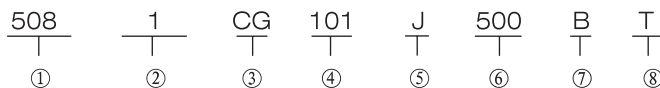

①Dimensions		
Type	British (Inch)	Metric (mm)
508	0.05 × 0.08	1.25 × 2.0
512	0.05 × 0.12	1.25 × 3.20
618	0.06 × 0.18	1.60 × 4.57

②Code	
1	Electromagnetism Disturbance Suppression

③Dielectric Type	
Code	Dielectric Material
CG	NPO
B	X7R
F	Y5V

④Normal Capacitance(PF)	
Expression Method	Actual Value
102	$10 \times 10^2$
222	$22 \times 10^2$

⑤Capacitance Tolerance	
CODE	TOLERANCE
M	± 20%
S	+50% ~ 20%

⑥Rated Voltage	
Expression Method	Actual Value
6R3	6.3
160	16
250	25
101	100

⑦Rated Current	
Expression Method	Actual Value
B	0.3A
C	0.4A
D	1A
E	2A

⑧Package Method	
Expression Method	Packaging
NOMARKS	Bulk Bag Packaging
T	Taping Packaging
B	Bulk Plastic Box Packaging

### • Outside Dimension

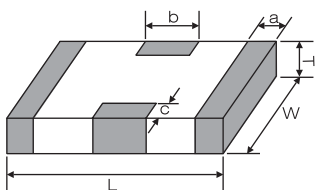

Item Size	L	W	H	Termination thickness	Third Termination Width	Third Termination Thickness
508	$2.00 \pm 0.20$	$1.25 \pm 0.20$	$0.80 \pm 0.20$	$0.25 \pm 0.10$	$0.60 \pm 0.20$	$0.25 \pm 0.15$
512	$3.20 \pm 0.20$	$1.25 \pm 0.20$	$0.70 \pm 0.20$	$0.30 \pm 0.20$	$1.10 \pm 0.30$	$0.25 \pm 0.20$
618	$4.50 \pm 0.30$	$1.60 \pm 0.20$	$1.00 \pm 0.20$	$0.40 \pm 0.30$	$1.50 \pm 0.30$	$0.30 \pm 0.20$

# 多層片式陶瓷電容器

## MULTILAYER CHIP CERAMIC CAPACITOR

- 電容量範圍

項目	5081型EMI							5081型EMI						
	COG							X7R						
介質種類	COG							X7R						
工作電壓	4V	6.3V	10V	16V	25V	50V	100V	4V	6.3V	10V	16V	25V	50V	100V
電容量														
10PF														
15PF														
20PF														
22PF														
33PF														
47PF														
100PF														
150PF														
220PF														
330PF														
470PF														
1000PF														
1.2nF														
3.3nF														
4.7nF														
5.6nF														
10nF														
22nF														
33nF														
47nF														
56nF														
100nF														
120nF														
220nF														
330nF														
470nF														
1 μF														
2.2 μF														

• Capacitance Range

Item	5081型EMI							5081型EMI						
	COG							X7R						
Dielectric Type	COG							X7R						
Rated Volatage	4V	6.3V	10V	16V	25V	50V	100V	4V	6.3V	10V	16V	25V	50V	100V
Capacitance														
10PF														
15PF														
20PF														
22PF														
33PF														
47PF														
100PF														
150PF														
220PF														
330PF														
470PF														
1000PF														
1.2nF														
3.3nF														
4.7nF														
5.6nF														
10nF														
22nF														
33nF														
47nF														
56nF														
100nF														
120nF														
220nF														
330nF														
470nF														
1 μ F														
2.2 μ F														

# 多層片式陶瓷電容器

## MULTILAYER CHIP CERAMIC CAPACITOR

- 電容量範圍

項目	5121型EMI										5121型EMI									
介質種類	COG										X7R									
工作電壓	4V	6.3V	10V	16V	25V	50V	100V	200V	250V	4V	6.3V	10V	16V	25V	50V	100V	200V	250V		
電容量																				
10PF	■	■	■	■	■	■	■	■	■											
15PF	■	■	■	■	■	■	■	■	■											
20PF	■	■	■	■	■	■	■	■	■											
22PF	■	■	■	■	■	■	■	■	■											
33PF	■	■	■	■	■	■	■	■	■											
47PF	■	■	■	■	■	■	■	■	■											
100PF	■	■	■	■	■	■	■	■	■											
150PF	■	■	■	■	■	■	■	■	■											
220PF	■	■	■	■	■	■	■	■	■											
330PF	■	■	■	■	■	■	■	■	■											
470PF	■	■	■	■	■	■	■	■	■											
820PF	■	■	■	■	■	■	■	■	■	■	■	■	■	■	■	■	■	■		
1000PF	■	■	■	■	■	■	■	■	■	■	■	■	■	■	■	■	■	■		
1.5nF	■	■	■	■	■	■	■	■	■	■	■	■	■	■	■	■	■	■		
3.3nF	■	■	■	■	■	■	■	■	■	■	■	■	■	■	■	■	■	■		
4.7nF	■	■	■	■	■	■	■	■	■	■	■	■	■	■	■	■	■	■		
5.6nF	■	■	■	■	■	■	■	■	■	■	■	■	■	■	■	■	■	■		
10nF	■	■	■	■	■	■	■	■	■	■	■	■	■	■	■	■	■	■		
22nF	■	■	■	■	■	■	■	■	■	■	■	■	■	■	■	■	■	■		
33nF	■	■	■	■	■	■	■	■	■	■	■	■	■	■	■	■	■	■		
47nF	■	■	■	■	■	■	■	■	■	■	■	■	■	■	■	■	■	■		
68nF	■	■	■	■	■	■	■	■	■	■	■	■	■	■	■	■	■	■		
100nF	■	■	■	■	■	■	■	■	■	■	■	■	■	■	■	■	■	■		
120nF	■	■	■	■	■	■	■	■	■	■	■	■	■	■	■	■	■	■		
220nF	■	■	■	■	■	■	■	■	■	■	■	■	■	■	■	■	■	■		
330nF	■	■	■	■	■	■	■	■	■	■	■	■	■	■	■	■	■	■		
470nF	■	■	■	■	■	■	■	■	■	■	■	■	■	■	■	■	■	■		
1 μF	■	■	■	■	■	■	■	■	■	■	■	■	■	■	■	■	■	■		

- Capacitance Range

Item	5121 EMI										5121 EMI									
	COG										X7R									
Dielectric Type	COG										X7R									
Rated Volatage	4V	6.3V	10V	16V	25V	50V	100V	200V	250V	4V	6.3V	10V	16V	25V	50V	100V	200V	250V		
Capacitance																				
10PF																				
15PF																				
20PF																				
22PF																				
33PF																				
47PF																				
100PF																				
150PF																				
220PF																				
330PF																				
470PF																				
820PF																				
1000PF																				
1.5nF																				
3.3nF																				
4.7nF																				
5.6nF																				
10nF																				
22nF																				
33nF																				
47nF																				
68nF																				
100nF																				
120nF																				
220nF																				
330nF																				
470nF																				
1 μ F																				



## 多層片式陶瓷電容器

### MULTILAYER CHIP CERAMIC CAPACITOR

#### ■安全規格認證GF型多層陶瓷電容器

##### ● 特性

- \* 新型獨石結構，體積小，電容量高，能在高壓下工作。
- \* 符合UL60950-1標準。
- \* 僅用于回流焊接。
- \* 它們實用于薄型設備。

##### ● 應用範圍

- \* 適合于無變壓器的DAA調制調解器綫路濾波器及耦合用。
- \* 適合信息設備綫路濾波器用。

##### ● 產品規格型號表示方法

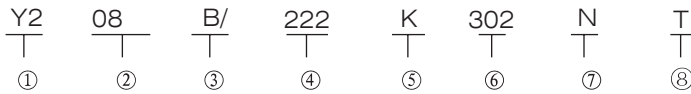

①代號
安規電容器

②尺寸		
型號	英制(英寸)	公制(毫米)
08	0.18 × 0.08	4.50 × 2.00
12	0.18 × 0.12	4.50 × 3.20
20	0.22 × 0.20	5.70 × 5.00
25	0.22 × 0.25	5.70 × 6.30

③介質種類	
代碼	介質材料
CG	COG或NPO
B	X7R

④標稱電容量(PF)	
表示方式	實際值
102	$10 \times 10^2$
222	$22 \times 10^2$

⑤誤差級別	
代碼	誤差
J	± 5%
K	± 10%
M	± 20%

⑥特定交流工作電壓	
302	交流250V

⑦端頭類別	
表示方法	端頭材料
S	純銀端頭
C	純銅端頭
N	三層電鍍端頭 (銀或銅層/鎳層/錫層)

⑧包裝方式	
表示方法	包裝
無標記	袋裝散包裝
T	編帶包裝
B	塑料盒散包裝

##### ● 外形尺寸

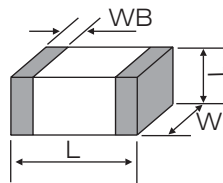

代號	規格型號	尺寸( mm )			
		L	W	T	WB
08	1808	4.50 ± 0.40	2.00 ± 0.20	≤ 2.5	0.75 ± 0.25
12	1812	4.50 ± 0.40	3.20 ± 0.30	≤ 3.5	0.80 ± 0.30
20	2220	5.70 ± 0.40	5.00 ± 0.40	≤ 3.5	1.00 ± 0.40
25	2225	5.70 ± 0.50	6.30 ± 0.50	≤ 3.5	1.00 ± 0.40

## ■ Type MLCC

### ● Features

- \* A New monolithic structure capacitor for small, high-capacitance capability of operating at high-voltage levels.
- \* Available for equipment base on UL60950-1.
- \* Only for reflow soldering
- \* Fit for use on thin type equipment.

### ● Application

- \* Ideal for use on line filters and couplings for DAA modems without transformers.
- \* Ideal for use on line filters for information equipment.

### ● Product Part Number Expression

$\frac{Y2}{\text{①}}$      $\frac{08}{\text{②}}$      $\frac{B}{\text{③}}$      $\frac{222}{\text{④}}$      $\frac{K}{\text{⑤}}$      $\frac{302}{\text{⑥}}$      $\frac{N}{\text{⑦}}$      $\frac{T}{\text{⑧}}$

① Code
Y2 Capacitor

② Dimensions		
Type	British (Inch)	Metric (mm)
08	0.18 × 0.08	4.50 × 2.00
12	0.18 × 0.12	4.50 × 3.20
20	0.22 × 0.20	5.70 × 5.00
25	0.22 × 0.25	5.70 × 5.00

⑥ Rated Voltage	
Expression Method	Actual Value
302	AC 250 voltages

③ Dielectric Type	
Code	Dielectric Material
CG	COG or NPO
B	X7R

④ Normal Capacitance	
Expression Method	Actual Value
102	$10 \times 10^2$
222	$22 \times 10^2$

⑤ Capacitance Tolerance (PF)	
Code	Tolerance
J	± 5%
K	± 10%
M	± 20%

⑦ Termination Type	
Expression Method	Termination Material
S	Pure Silver
C	Pure Copper
N	Three Layers Plating Terminal (Silver or Copper layer/ Nickel layer /Tin layer)

⑧ Package Method	
Expression Method	Packaging
NOMARKS	Bulk Bag Packaging
T	Taping Packaging
B	Bulk Plastic Box Packaging

### ● Outside Dimension

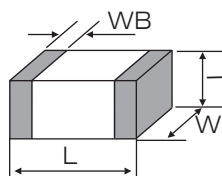

代號	規格型號	尺寸 (mm)			
		L	W	T	WB
08	1808	$4.50 \pm 0.40$	$2.00 \pm 0.20$	$\leq 2.5$	$0.75 \pm 0.25$
12	1812	$4.50 \pm 0.40$	$3.20 \pm 0.30$	$\leq 3.5$	$0.80 \pm 0.30$
20	2220	$5.70 \pm 0.40$	$5.00 \pm 0.40$	$\leq 3.5$	$1.00 \pm 0.40$
25	2225	$5.70 \pm 0.50$	$6.30 \pm 0.50$	$\leq 3.5$	$1.00 \pm 0.40$

# 多層片式陶瓷電容器

## MULTILAYER CHIP CERAMIC CAPACITOR

- 電容量範圍

項目	安規電容器								電容量
	COG				X7R				
介質種類									
尺寸	1808	1812	2220	2225	1808	1812	2220	2225	
電容量									電容量
2PF									2PF
10PF									10PF
22PF									22PF
33PF									33PF
47PF									47PF
56PF									56PF
68PF									68PF
82PF									82PF
100pF									100pF
150pF									150pF
220pF									220pF
330pF									330pF
470pF									470pF
680pF									680pF
1.0nF									1.0nF
2.2nF									2.2nF
3.3nF									3.3nF
4.7nF									4.7nF
6.8nF									6.8nF
10nF									10nF
22nF									22nF

• Capacitance Range

Item	Safety Standard Recognized Type GF MLCC								
	COG				X7R				
Dielectric Type									
Dimension	1808	1812	2220	2225	1808	1812	2220	2225	
Capacitance									Capacitance
2PF									2PF
10PF									10PF
22PF									22PF
33PF									33PF
47PF									47PF
56PF									56PF
68PF									68PF
82PF									82PF
100pF									100pF
150pF									150pF
220pF									220pF
330pF									330pF
470pF									470pF
680pF									680pF
1.0nF									1.0nF
2.2nF									2.2nF
3.3nF									3.3nF
4.7nF									4.7nF
6.8nF									6.8nF
10nF									10nF
22nF									22nF

# 多層片式陶瓷電容器

## MULTILAYER CHIP CERAMIC CAPACITOR

### ■ 包裝

- 紙帶卷盤結構

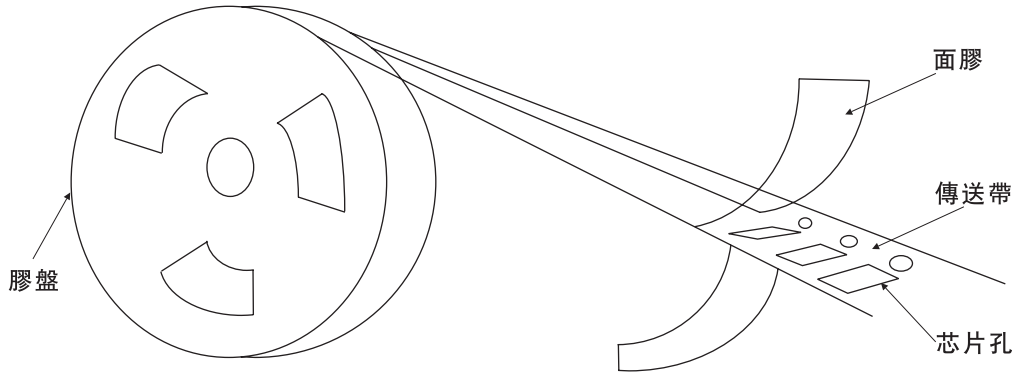

\* 適合 0402,0603, 0805, 1206 常規尺寸產品的紙帶尺寸

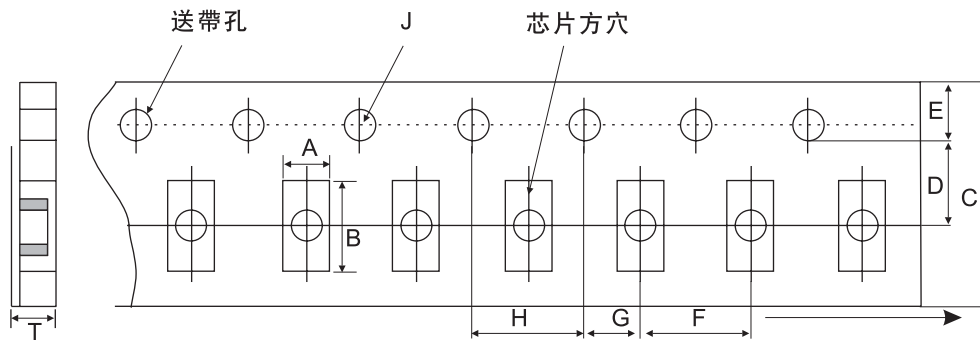

代號 紙帶規格	A	B	C	D	E	F	G	H	J	T*
0201	0.37 ±0.10	0.67 ±0.10	8.00 ±0.10	3.50 ±0.05	1.75 ±0.10	2.00 ±0.10	2.00 ±0.10	4.00 ±0.10	1.50-0/ +0.10	低于 0.80
0402	0.65 ±0.10	1.15 ±0.10	8.00 ±0.10	3.50 ±0.05	1.75 ±0.10	2.00 ±0.05	2.00 ±0.05	4.00 ±0.10	1.50-0/ +0.10	低于 0.80
0603	1.10 ±0.20	1.90 ±0.20	8.00 ±0.20	3.50 ±0.05	1.75 ±0.10	4.00 ±0.10	2.00 ±0.10	4.00 ±0.10	1.50-0/ +0.10	低于 1.10
0805	1.45 ±0.20	2.30 ±0.20	8.00 ±0.20	3.50 ±0.05	1.75 ±0.10	4.00 ±0.10	2.00 ±0.10	4.00 ±0.10	1.50-0/ +0.10	低于 1.10
1206	1.80 ±0.20	3.40 ±0.20	8.00 ±0.20	3.50 ±0.05	1.75 ±0.10	4.00 ±0.10	2.00 ±0.10	4.00 ±0.10	1.50-0/ +0.10	低于 1.10

## ■ Package

- Paper Tape Taping

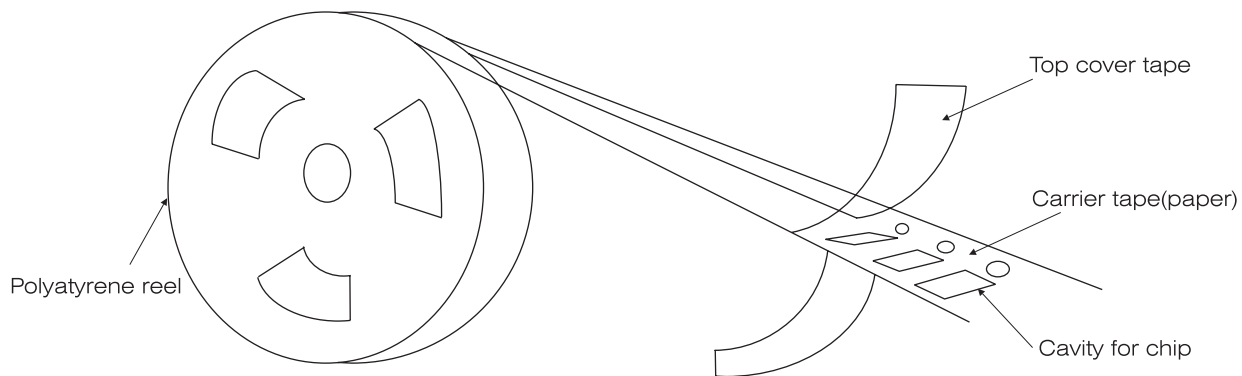

※Dimensions of paper take taping for 0402, 0603, 0805, 1206

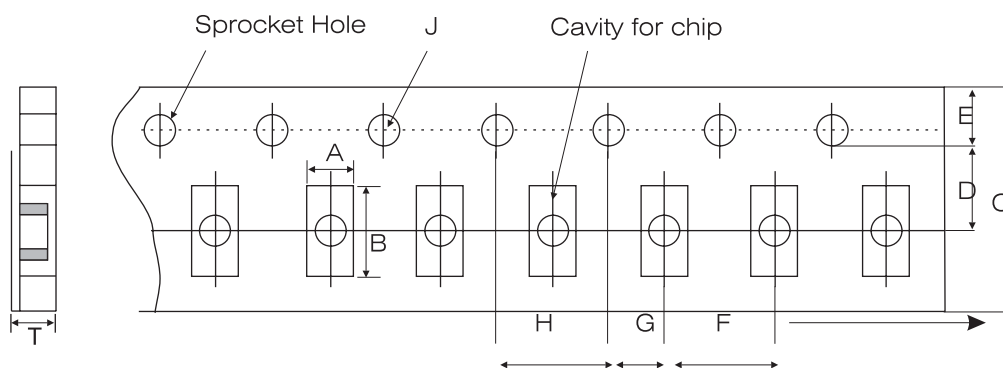

Code Paper size	A	B	C	D	E	F	G	H	J	T*
0201	0.37 ±0.10	0.67 ±0.10	8.00 ±0.10	3.50 ±0.05	1.75 ±0.10	2.00 ±0.10	2.00 ±0.10	4.00 ±0.10	1.50-0/ +0.10	Below 0.80
0402	0.65 ±0.10	1.15 ±0.10	8.00 ±0.10	3.50 ±0.05	1.75 ±0.10	2.00 ±0.05	2.00 ±0.05	4.00 ±0.10	1.50-0/ +0.10	Below 0.80
0603	1.10 ±0.20	1.90 ±0.20	8.00 ±0.20	3.50 ±0.05	1.75 ±0.10	4.00 ±0.10	2.00 ±0.10	4.00 ±0.10	1.50-0/ +0.10	Below 1.10
0805	1.45 ±0.20	2.30 ±0.20	8.00 ±0.20	3.50 ±0.05	1.75 ±0.10	4.00 ±0.10	2.00 ±0.10	4.00 ±0.10	1.50-0/ +0.10	Below 1.10
1206	1.80 ±0.20	3.40 ±0.20	8.00 ±0.20	3.50 ±0.05	1.75 ±0.10	4.00 ±0.10	2.00 ±0.10	4.00 ±0.10	1.50-0/ +0.10	Below 1.10

# 多層片式陶瓷電容器

## MULTILAYER CHIP CERAMIC CAPACITOR

### ■ 包裝

- 紙帶卷盤結構

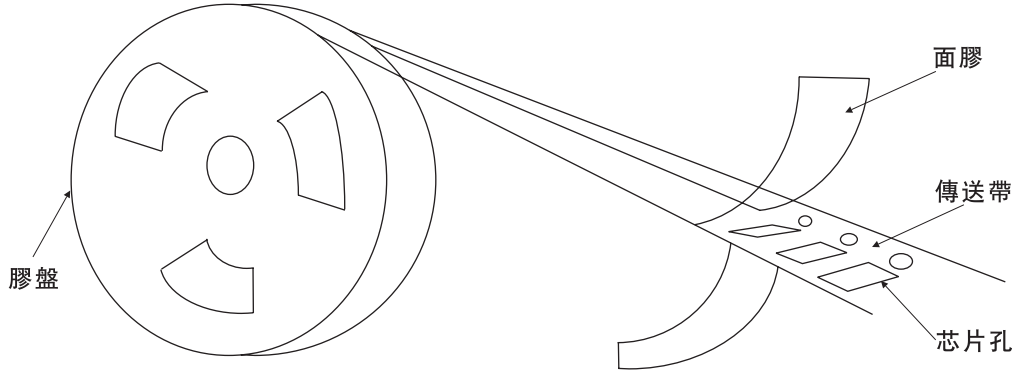

\* 適合0805, 1206, 1210, 1808, 1812常規尺寸產品的塑膠帶尺寸

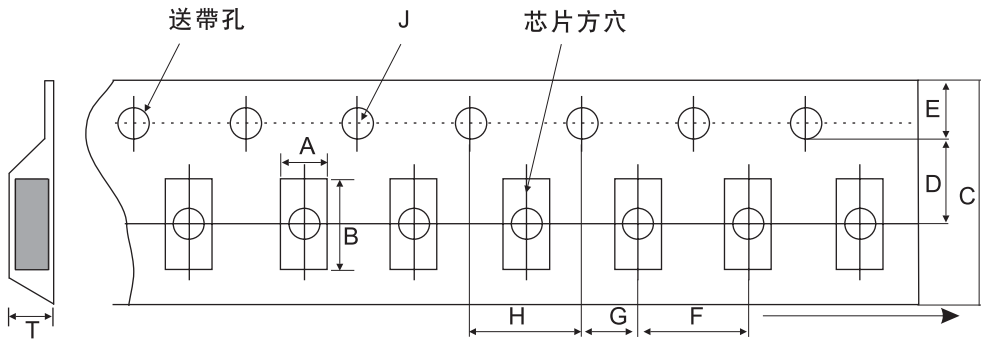

代號 紙帶規格	A	B	C	D	E	F*	G	H	J	T
0805	1.55 ±0.20	2.35 ±0.20	8.00 ±0.20	3.50 ±0.05	1.75 ±0.10	4.00 ±0.10	2.00 ±0.10	4.00 ±0.10	1.50-0/ +0.10	低于 1.50
1206	1.95 ±0.20	3.60 ±0.20	8.00 ±0.20	3.50 ±0.05	1.75 ±0.10	4.00 ±0.10	2.00 ±0.10	4.00 ±0.10	1.50-0/ +0.10	低于 1.85
1210	2.70 ±0.10	3.42 ±0.10	8.00 ±0.10	3.50 ±0.05	1.75 ±0.10	4.00 ±0.10	2.00 ±0.05	4.00 ±0.10	1.50-0/ +0.10	低于 3.2
1808	2.20 ±0.10	4.95 ±0.10	12.00 ±0.10	5.50 ±0.05	1.75 ±0.10	4.00 ±0.10	2.00 ±0.05	4.00 ±0.10	1.50-0/ +0.10	低于 3.0
1812	3.66 ±0.10	4.95 ±0.10	12.00 ±0.10	5.50 ±0.05	1.75 ±0.10	8.00 ±0.10	2.00 ±0.05	4.00 ±0.10	1.50-0/ +0.10	低于 4.0

注意:\*表示此處對尺寸的要求非常精確

• Embossed Taping

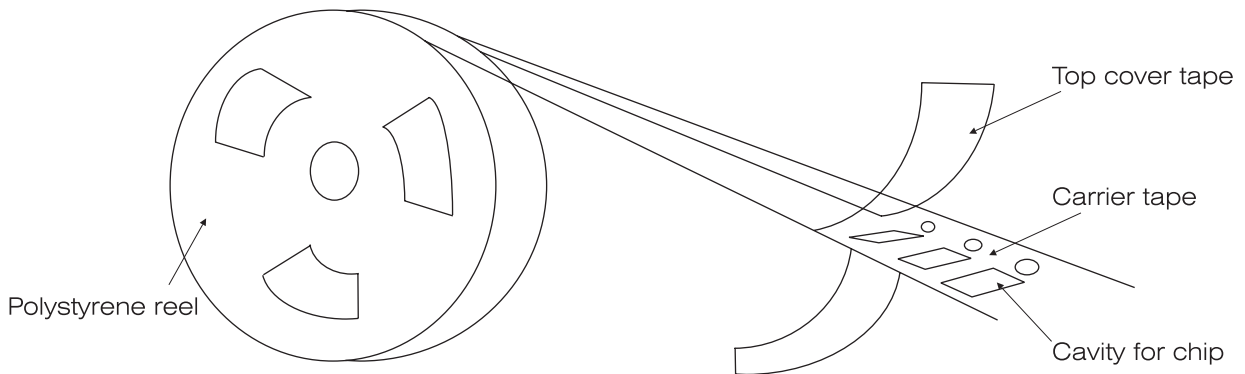

※Dimensions of embossed taping for 0805, 1206, 1210, 1808, 1812 type

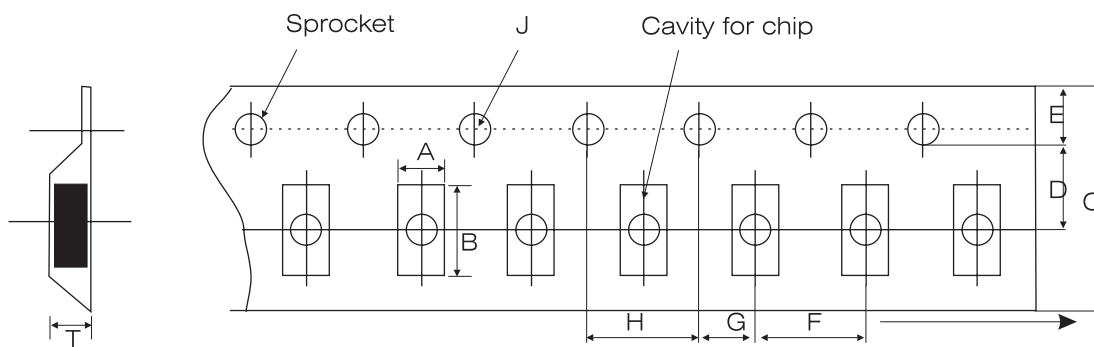

Code Tape size	A	B	C	D	E	F*	G	H	J	T
0805	1.55 ±0.20	2.35 ±0.20	8.00 ±0.20	3.50 ±0.05	1.75 ±0.10	4.00 ±0.10	2.00 ±0.10	4.00 ±0.10	1.50-0/ +0.10	Below 1.50
1206	1.95 ±0.20	3.60 ±0.20	8.00 ±0.20	3.50 ±0.05	1.75 ±0.10	4.00 ±0.10	2.00 ±0.10	4.00 ±0.10	1.50-0/ +0.10	Below 1.85
1210	2.70 ±0.10	3.42 ±0.10	8.00 ±0.10	3.50 ±0.05	1.75 ±0.10	4.00 ±0.10	2.00 ±0.05	4.00 ±0.10	1.50-0/ +0.10	Below 3.2
1808	2.20 ±0.10	4.95 ±0.10	12.00 ±0.10	5.50 ±0.05	1.75 ±0.10	4.00 ±0.10	2.00 ±0.05	4.00 ±0.10	1.50-0/ +0.10	Below 3.0
1812	3.66 ±0.10	4.95 ±0.10	12.00 ±0.10	5.50 ±0.05	1.75 ±0.10	8.00 ±0.10	2.00 ±0.05	4.00 ±0.10	1.50-0/ +0.10	Below 4.0

Note: The place with "\*" means where needs exactly dimensions.



# 多層片式陶瓷電容器

## MULTILAYER CHIP CERAMIC CAPACITOR

- 傳送帶的前後結構

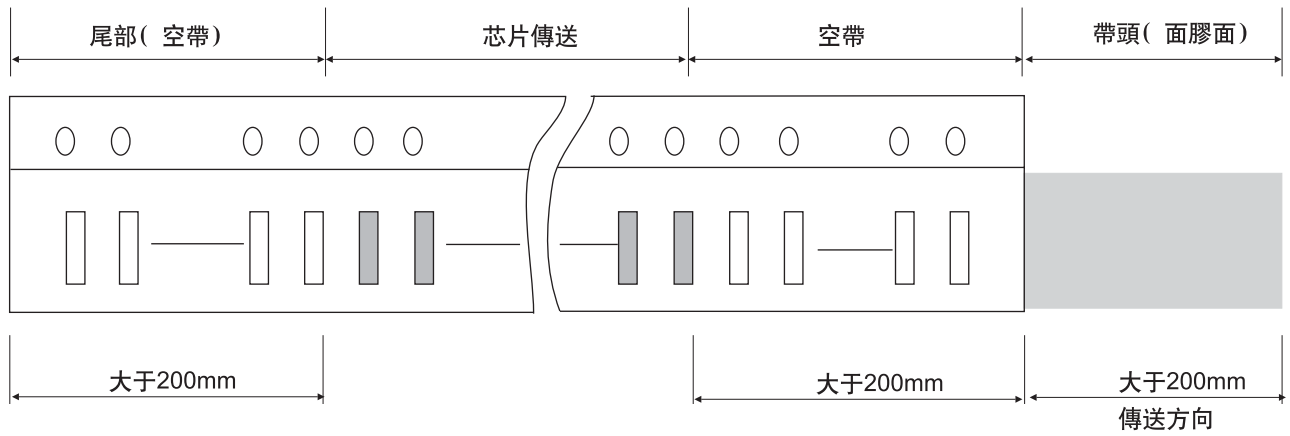

- 卷盤尺寸(單位:mm)

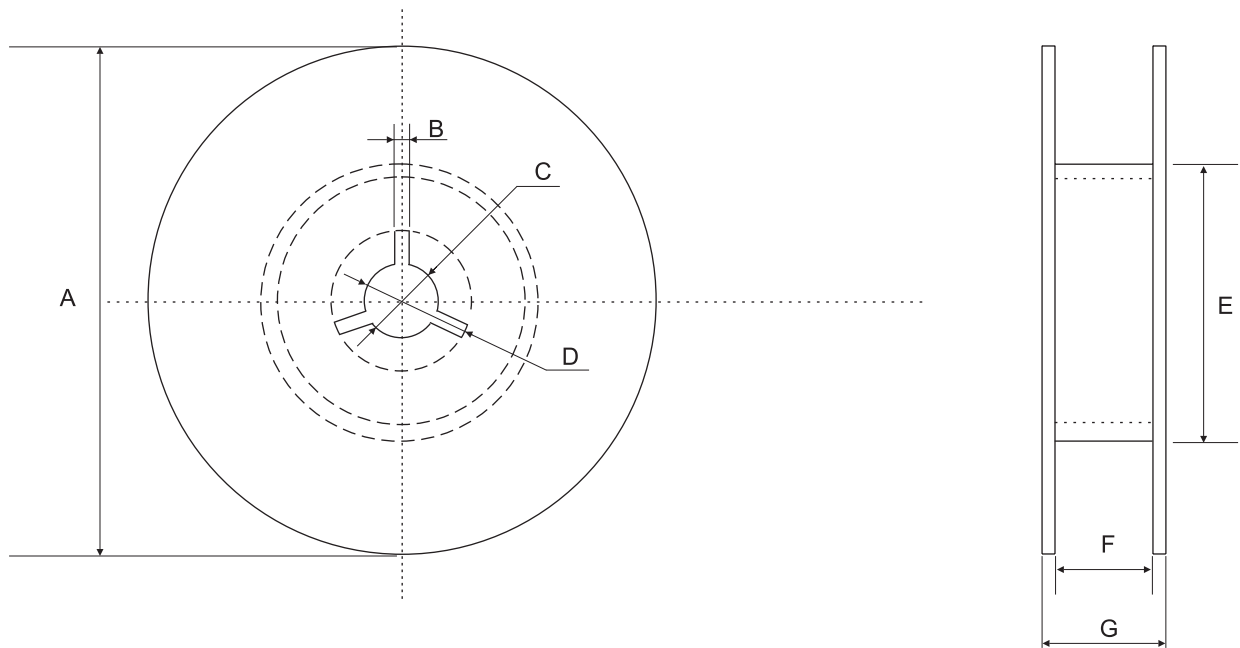

- 尺寸代碼

A	B	C	D	E	F	G
$\Phi 178.00 \pm 2.00$	3.00	$\Phi 13.00 \pm 0.50$	$\Phi 21.00 \pm 0.80$	$\Phi 50.00$ 或更大	$10.00 \pm 1.50$	12MAX
$\Phi 330.00 \pm 2.00$	3.00	$\Phi 13.00 \pm 0.50$	$\Phi 21.00 \pm 0.80$	$\Phi 50.00$ 或更大	$10.00 \pm 1.50$	12MAX

• Structure of leader part and end part of the carrier paper

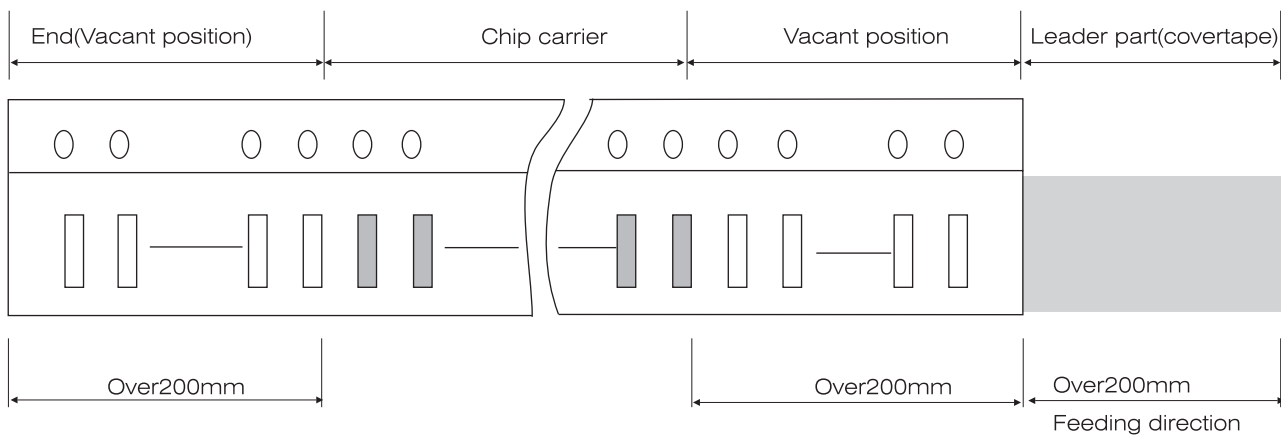

• Reel Dimensions (unit:mm)

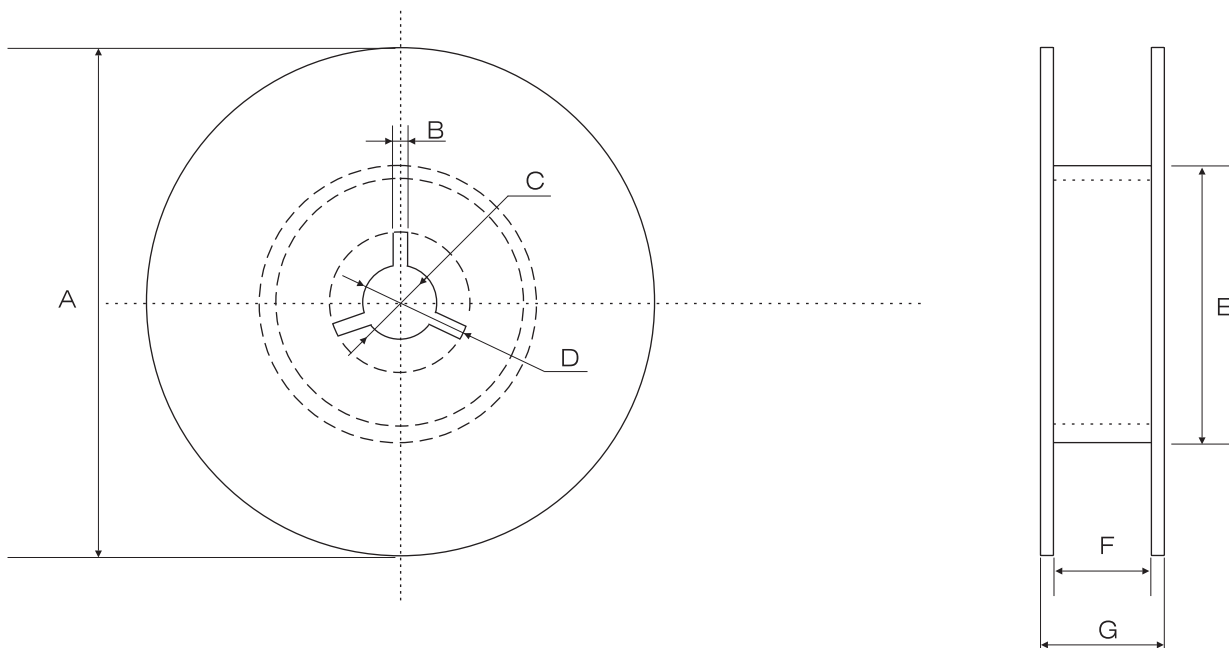

• Code

A	B	C	D	E	F	G
$\Phi 178.00 \pm 2.00$	3.00	$\Phi 13.00 \pm 0.50$	$\Phi 21.00 \pm 0.80$	$\Phi 50.00$ or max	$10.00 \pm 1.50$	12MAX
$\Phi 330.00 \pm 2.00$	3.00	$\Phi 13.00 \pm 0.50$	$\Phi 21.00 \pm 0.80$	$\Phi 50.00$ or max	$10.00 \pm 1.50$	12MAX

# 多層片式陶瓷電容器

## MULTILAYER CHIP CERAMIC CAPACITOR

### 關於卷帶的說明

- 面膠剝離強度

(A)紙帶

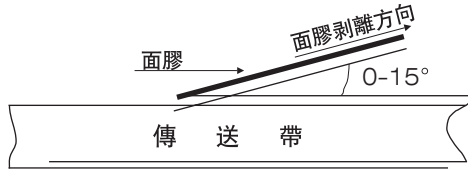

(B)塑料膠盤

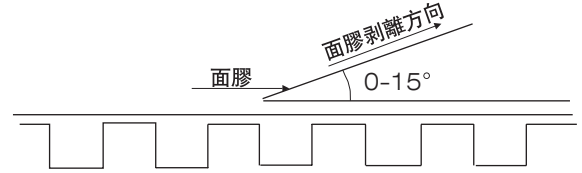

標準：0.1N<剝離強度<0.7N；在剝離時，紙帶不能有紙碎，也不能粘在底、面膠上。

- 塑料盒散包裝

標示	A	B	T	C	D	E
尺寸	6.80±0.10	8.80±1.00	12.00±0.10	15.00+0.10/-0	2.00±0/-0.10	4.70±0.10
標示	F	W	G	H	L	I
尺寸	31.50+0.20/-0	36.00+0/-0.2	19.00±0.35	7.00±0.35	110.00±0.70	5.00±0.35

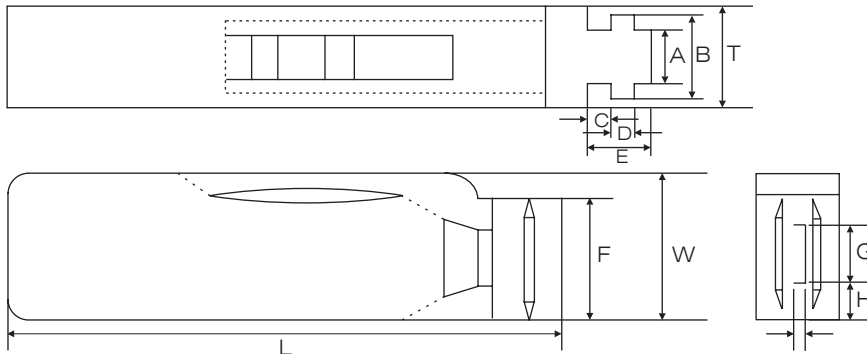

- 包裝數量

尺寸	包裝形式和數量			
	紙帶卷盤	膠帶卷盤	塑料盒散裝	一般散裝
0402	10000		20000	5000
0603	4000		15000	5000
0805	4000	3000	10000	5000
1206	4000	T≤1.35mm 3000 T>1.35mm 2000	5000	5000
1210		T≤1.80mm 2000 T>1.80mm 1000		2000
1808		2000		2000
1812		T≤1.85mm 1000 T>1.85mm 500		2000
2225		500		500
3035		500		

注意：包裝的形式和數量可根據客戶的要求來定。

## ■ TAPING SPECIFICATION

- Top cover tape peeling strength

(A) Paper Taping

(b) Cover tape peeling direction

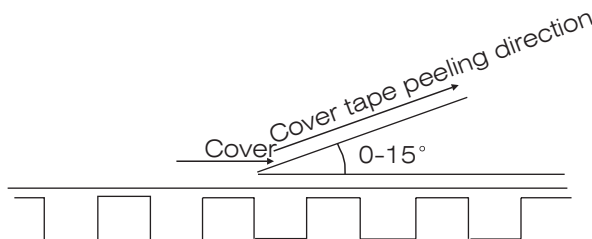
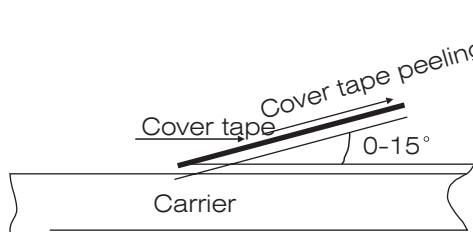

Standard:  $0.1N < \text{peeling forc} < 0.7N$ ;

No paper dirty remains on the scotch when peeling, and no sticks to top and bottom cover tape.

- Bulk Case Package

Symbol	A	B	T	C	D	E
Dimension	$6.80 \pm 0.10$	$8.80 \pm 1.00$	$12.00 \pm 0.10$	$15.00 + 0.10 / -1$	$2.00 \pm 0 / -0.10$	$4.70 \pm 0.10$
Symol	F	W	G	H	L	I
Dimension	$31.50 + 0.20 / -0$	$36.00 + 0 / -0.2$	$19.00 \pm 0.35$	$7.00 \pm 0.35$	$110.00 \pm 0.70$	$5.00 \pm 0.35$

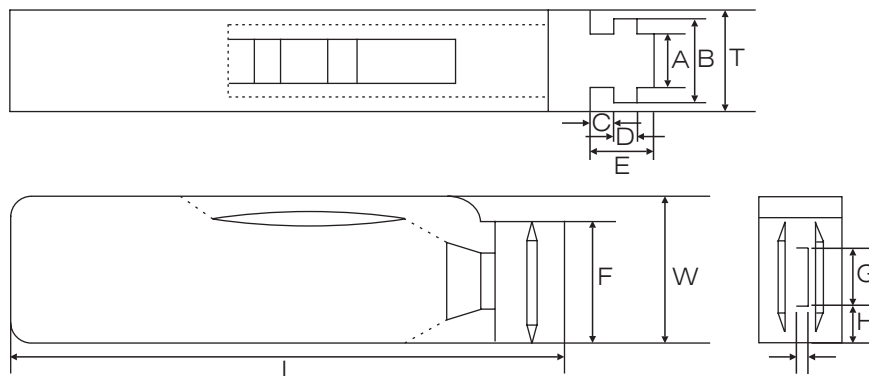

- Pack Quantity

Size	Pakaging method and quantity			
	Paper tape taping	Plastic embossed taping	Bulk plastic box packaging	Normal bulk packaging
0402	10000		20000	5000
0603	4000		15000	5000
0805	4000	3000	10000	5000
1206	4000	T ≤ 1.35mm 3000 T > 1.35mm 2000	5000	5000
1210		T ≤ 1.80mm 2000 T > 1.80mm 1000		2000
1808		2000		2000
1812		T ≤ 1.85mm 1000 T > 1.85mm 500		2000
2225		500		500
3035		500		

Note: We can choose packing style and quantity can be according to the customer's requirement.

■ 通用型片式電容使用注意事項

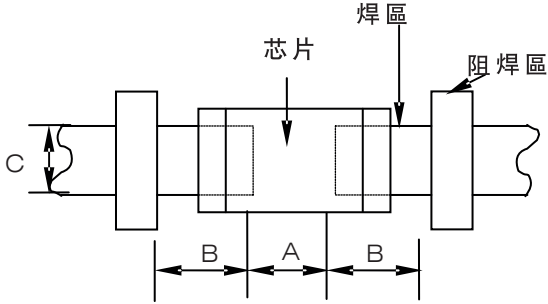
階段	預防	注意事項																																																																														
1 綫路設計	<p>使用環境的確認： 醫療器械、航空用器、原子彈反應器如果出現故障，會對人的生命和整個社會造成巨大的損壞。因此用于這些設備的電容器必須具有很高的可靠性和安全性，并且比用于普通應用的電容器元件的要求更高，其區別也很明顯。</p>	<p>電子額定系數和性能的工作電壓（額定電壓的確認）</p> <ol style="list-style-type: none"> <li>1. 電容器的工作電壓應比其額定電壓低。如果在一DC電壓上加載一個AC電壓，那么兩個峰值電壓之和應小于所選擇的電容器的額定值。對於同時使用AC電壓和脈衝電壓的電路，它們的峰值電壓之和也應低于電容器的額定電壓。</li> <li>2. 甚至在供給的電壓低于額定電壓值時，如果電路中使用的高頻AC電壓或脈衝電壓升高的時間過快，那么電容器的性能會因此被減弱。</li> </ol>																																																																														
2. PCB板的設計	<p>基板配置（墊板的設計）</p> <p>當電容器被安裝在PCB板上后，所使用的焊料的量（焊盤的大小）會直接影響電容器的性能。因此在設計焊盤時必須考慮到以下幾點：</p> <ol style="list-style-type: none"> <li>1. 所用焊料的量的大小會影響芯片抗機械應力的能力，從而可能導致電容器破碎或開裂。因此在設計基板時，必須慎重考慮焊盤的大小和配置，這些對組成基板的焊料的量有着決定的作用。</li> <li>2. 如果不止一個元件被連續焊接在同一基板或焊盤上時，焊盤的設計應可以使每個元件的焊接點被阻焊區隔離開。</li> </ol>	<p>以下圖表為所推薦使用的墊板以防止過量的焊料量(基板較大時會超出元件的端頭)同時也給出了不合理的基板設計圖。</p> <p>以下為推薦使用的PCB上焊盤的尺寸</p>  <p>推薦用于波峰焊接的焊盤尺寸（單位：mm）</p> <table border="1"> <thead> <tr> <th>類型</th> <th>0603</th> <th>0805</th> <th>1206</th> <th>1210</th> </tr> </thead> <tbody> <tr> <td rowspan="2">尺寸</td> <td>L</td> <td>1.60</td> <td>2.00</td> <td>3.20</td> <td>3.20</td> </tr> <tr> <td>W</td> <td>0.80</td> <td>1.25</td> <td>1.60</td> <td>2.5</td> </tr> <tr> <td>A</td> <td>0.8~1.0</td> <td>1.0~1.4</td> <td>1.8~2.5</td> <td>1.8~2.5</td> </tr> <tr> <td>B</td> <td>0.5~0.8</td> <td>0.8~1.5</td> <td>0.8~1.7</td> <td>0.8~1.7</td> </tr> <tr> <td>C</td> <td>0.6~0.8</td> <td>0.9~1.2</td> <td>1.2~1.6</td> <td>1.8~2.5</td> </tr> </tbody> </table> <p>推薦用于回流焊接的焊盤尺寸（單位：mm）</p> <table border="1"> <thead> <tr> <th>類型</th> <th>0402</th> <th>0603</th> <th>0805</th> <th>1206</th> <th>1210</th> <th>1812</th> <th>2225</th> </tr> </thead> <tbody> <tr> <td rowspan="2">尺寸</td> <td>L</td> <td>1.10</td> <td>1.60</td> <td>2.00</td> <td>3.20</td> <td>3.20</td> <td>5.70</td> </tr> <tr> <td>W</td> <td>0.50</td> <td>0.80</td> <td>1.25</td> <td>1.60</td> <td>2.50</td> <td>3.20</td> </tr> <tr> <td>A</td> <td>0.45~0.55</td> <td>0.6~0.8</td> <td>0.8~1.2</td> <td>1.8~2.5</td> <td>1.8~2.5</td> <td>2.5~3.5</td> <td>3.7~4.7</td> </tr> <tr> <td>B</td> <td>0.40~0.50</td> <td>0.6~0.8</td> <td>0.6~1.2</td> <td>0.6~1.5</td> <td>0.6~1.5</td> <td>1.0~1.8</td> <td>1.0~2.3</td> </tr> <tr> <td>C</td> <td>0.45~0.55</td> <td>0.6~0.8</td> <td>0.9~1.6</td> <td>1.2~2.0</td> <td>1.8~3.2</td> <td>2.3~3.5</td> <td>3.5~5.5</td> </tr> </tbody> </table> <p>過量的焊料會影響芯片耐機械應力的能力。因此在設計基板時，需注意這些。</p>	類型	0603	0805	1206	1210	尺寸	L	1.60	2.00	3.20	3.20	W	0.80	1.25	1.60	2.5	A	0.8~1.0	1.0~1.4	1.8~2.5	1.8~2.5	B	0.5~0.8	0.8~1.5	0.8~1.7	0.8~1.7	C	0.6~0.8	0.9~1.2	1.2~1.6	1.8~2.5	類型	0402	0603	0805	1206	1210	1812	2225	尺寸	L	1.10	1.60	2.00	3.20	3.20	5.70	W	0.50	0.80	1.25	1.60	2.50	3.20	A	0.45~0.55	0.6~0.8	0.8~1.2	1.8~2.5	1.8~2.5	2.5~3.5	3.7~4.7	B	0.40~0.50	0.6~0.8	0.6~1.2	0.6~1.5	0.6~1.5	1.0~1.8	1.0~2.3	C	0.45~0.55	0.6~0.8	0.9~1.6	1.2~2.0	1.8~3.2	2.3~3.5	3.5~5.5
類型	0603	0805	1206	1210																																																																												
尺寸	L	1.60	2.00	3.20	3.20																																																																											
	W	0.80	1.25	1.60	2.5																																																																											
A	0.8~1.0	1.0~1.4	1.8~2.5	1.8~2.5																																																																												
B	0.5~0.8	0.8~1.5	0.8~1.7	0.8~1.7																																																																												
C	0.6~0.8	0.9~1.2	1.2~1.6	1.8~2.5																																																																												
類型	0402	0603	0805	1206	1210	1812	2225																																																																									
尺寸	L	1.10	1.60	2.00	3.20	3.20	5.70																																																																									
	W	0.50	0.80	1.25	1.60	2.50	3.20																																																																									
A	0.45~0.55	0.6~0.8	0.8~1.2	1.8~2.5	1.8~2.5	2.5~3.5	3.7~4.7																																																																									
B	0.40~0.50	0.6~0.8	0.6~1.2	0.6~1.5	0.6~1.5	1.0~1.8	1.0~2.3																																																																									
C	0.45~0.55	0.6~0.8	0.9~1.6	1.2~2.0	1.8~3.2	2.3~3.5	3.5~5.5																																																																									

## ■ Precautions for the use of general MLCC

Stages	Precaution	Technical considerations																																																																																
1.Circuit Design	<p>Verification of operating environment:</p> <p>If there were any malfunction in medical equipment, spacecraft or nuclear reactors, etc. it will causes serious damage to human life or social ramifications. For this reason , any capacitors to be used in such equipments must have very high safety and reliability considerations and must have high requirements than capacitor normal for applications.</p>	<p>Electrical rating and performance:</p> <p>Operating Voltage (Verification of Rated voltage)</p> <p>1. The operating voltage for capacitors must always be lower than their rated values.</p> <p>If an AC voltage is loaded on a DC voltage, the sum of the two peak voltages should be lower than the rated value of the capacitor chosen. For a circuit where both an AC and a pulse voltage may be present, the sum of their peak voltages should also be lower than the capacitor's rated voltage.</p> <p>2. Even if the applied voltage is lower than the rated value, the reliability of capacitors might be reduced if either a high frequency AC voltage or a pulse voltage having rapid rise time is present in the circuit.</p>																																																																																
2.PCB Design	<p>Pattern configurations (Design of Land-patterns)</p> <p>When capacitors are mounted on a PCB, the amount of solder used (size of fillet) can directly affect capacitor performance. Therefore, the following items must be carefully considered in the design of solder land patterns:</p> <p>(1)The amount of solder applied can affect the ability of chips to withstand mechanical stresses, which may lead to breaking or cracking. Therefore, when designing land-patterns it is necessary to consider the appropriate size and configuration of the solder pads, which determines the amount of solder necessary to form the fillets.</p> <p>(2) When more than one part is jointly soldered onto the same land or pad, the pad must be designed so that each components soldering point is separated by soldering-resist.</p>	<p>1. The following diagrams and tables show some examples of recommended patterns to prevent excessive solder amounts (larger fillets will extend above the components end terminations). Examples of improper pattern designs are also shown.</p> <p>Recommended land dimensions for PCB</p> <p>Recommend land dimensions for wave-soldering (unit: mm)</p> <table border="1"> <thead> <tr> <th>Type</th> <th>0603</th> <th>0805</th> <th>1206</th> <th>1210</th> </tr> </thead> <tbody> <tr> <td rowspan="2">Size</td> <td>L</td> <td>1.60</td> <td>2.00</td> <td>3.20</td> <td>3.20</td> </tr> <tr> <td>W</td> <td>0.80</td> <td>1.25</td> <td>1.60</td> <td>2.50</td> </tr> <tr> <td>A</td> <td>0.80~1.00</td> <td>1.00~1.40</td> <td>1.80~2.50</td> <td>1.80~2.50</td> </tr> <tr> <td>B</td> <td>0.50~0.80</td> <td>0.80~1.50</td> <td>0.80~1.70</td> <td>0.80~1.70</td> </tr> <tr> <td>C</td> <td>0.60~0.80</td> <td>0.90~1.20</td> <td>1.20~1.60</td> <td>1.80~2.50</td> </tr> </tbody> </table> <p>Recommend land dimensions for reflow-soldering (unit: mm)</p> <table border="1"> <thead> <tr> <th>Type</th> <th>0402</th> <th>0603</th> <th>0805</th> <th>1206</th> <th>1210</th> <th>1812</th> <th>2225</th> </tr> </thead> <tbody> <tr> <td rowspan="2">Size</td> <td>L</td> <td>1.00</td> <td>1.60</td> <td>2.00</td> <td>3.20</td> <td>3.20</td> <td>4.50</td> <td>5.70</td> </tr> <tr> <td>W</td> <td>0.50</td> <td>0.80</td> <td>1.25</td> <td>1.60</td> <td>2.50</td> <td>3.20</td> <td>6.30</td> </tr> <tr> <td>A</td> <td>0.45~0.55</td> <td>0.6~0.8</td> <td>0.8~1.2</td> <td>1.8~2.5</td> <td>1.8~2.5</td> <td>2.5~3.5</td> <td>3.7~4.7</td> </tr> <tr> <td>B</td> <td>0.40~0.50</td> <td>0.6~0.8</td> <td>0.6~1.2</td> <td>0.6~1.5</td> <td>0.6~1.5</td> <td>1.0~1.8</td> <td>1.0~2.3</td> </tr> <tr> <td>C</td> <td>0.45~0.55</td> <td>0.6~0.8</td> <td>0.9~1.6</td> <td>1.2~2.0</td> <td>1.8~3.2</td> <td>2.3~3.5</td> <td>3.5~5.5</td> </tr> </tbody> </table> <p>Excess solder can affect the ability of chips to withstand mechanical stresses. Therefore, please take proper precautions when designing land-patterns.</p>	Type	0603	0805	1206	1210	Size	L	1.60	2.00	3.20	3.20	W	0.80	1.25	1.60	2.50	A	0.80~1.00	1.00~1.40	1.80~2.50	1.80~2.50	B	0.50~0.80	0.80~1.50	0.80~1.70	0.80~1.70	C	0.60~0.80	0.90~1.20	1.20~1.60	1.80~2.50	Type	0402	0603	0805	1206	1210	1812	2225	Size	L	1.00	1.60	2.00	3.20	3.20	4.50	5.70	W	0.50	0.80	1.25	1.60	2.50	3.20	6.30	A	0.45~0.55	0.6~0.8	0.8~1.2	1.8~2.5	1.8~2.5	2.5~3.5	3.7~4.7	B	0.40~0.50	0.6~0.8	0.6~1.2	0.6~1.5	0.6~1.5	1.0~1.8	1.0~2.3	C	0.45~0.55	0.6~0.8	0.9~1.6	1.2~2.0	1.8~3.2	2.3~3.5	3.5~5.5
Type	0603	0805	1206	1210																																																																														
Size	L	1.60	2.00	3.20	3.20																																																																													
	W	0.80	1.25	1.60	2.50																																																																													
A	0.80~1.00	1.00~1.40	1.80~2.50	1.80~2.50																																																																														
B	0.50~0.80	0.80~1.50	0.80~1.70	0.80~1.70																																																																														
C	0.60~0.80	0.90~1.20	1.20~1.60	1.80~2.50																																																																														
Type	0402	0603	0805	1206	1210	1812	2225																																																																											
Size	L	1.00	1.60	2.00	3.20	3.20	4.50	5.70																																																																										
	W	0.50	0.80	1.25	1.60	2.50	3.20	6.30																																																																										
A	0.45~0.55	0.6~0.8	0.8~1.2	1.8~2.5	1.8~2.5	2.5~3.5	3.7~4.7																																																																											
B	0.40~0.50	0.6~0.8	0.6~1.2	0.6~1.5	0.6~1.5	1.0~1.8	1.0~2.3																																																																											
C	0.45~0.55	0.6~0.8	0.9~1.6	1.2~2.0	1.8~3.2	2.3~3.5	3.5~5.5																																																																											

# 多層片式陶瓷電容器

## MULTILAYER CHIP CERAMIC CAPACITOR

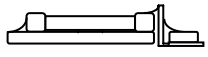
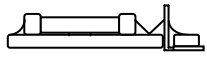
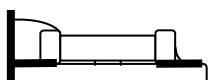
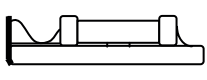
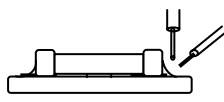
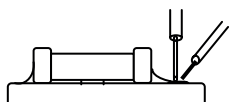
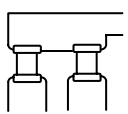
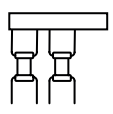
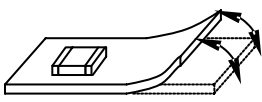
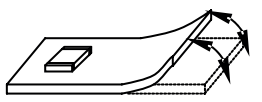
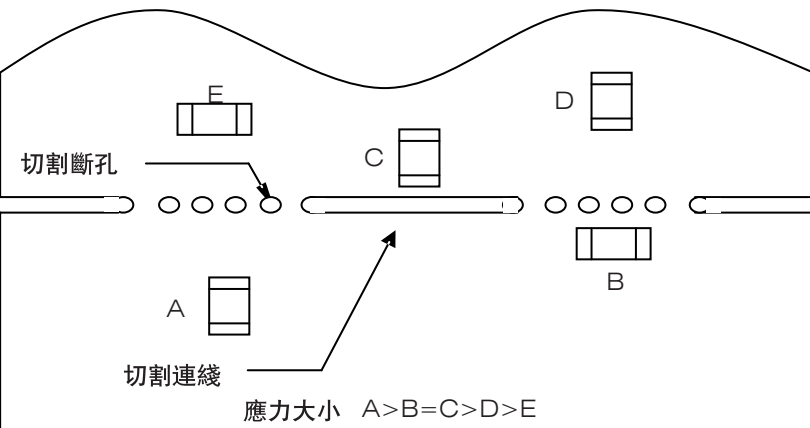
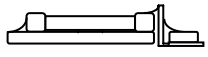
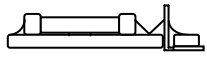
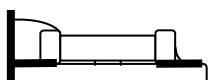
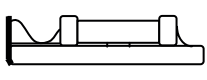
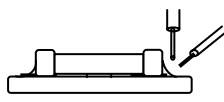
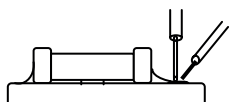
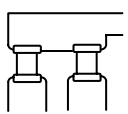
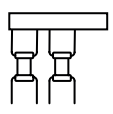
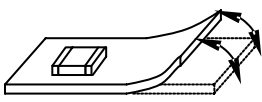
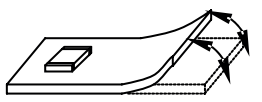
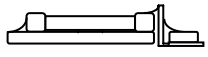
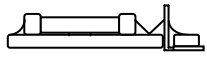
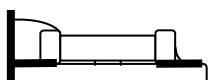
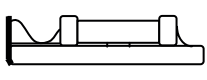
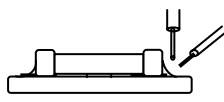
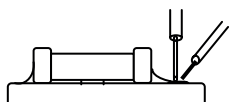
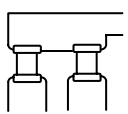
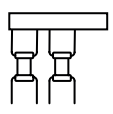
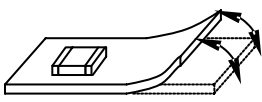
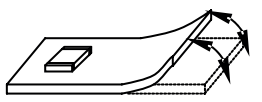

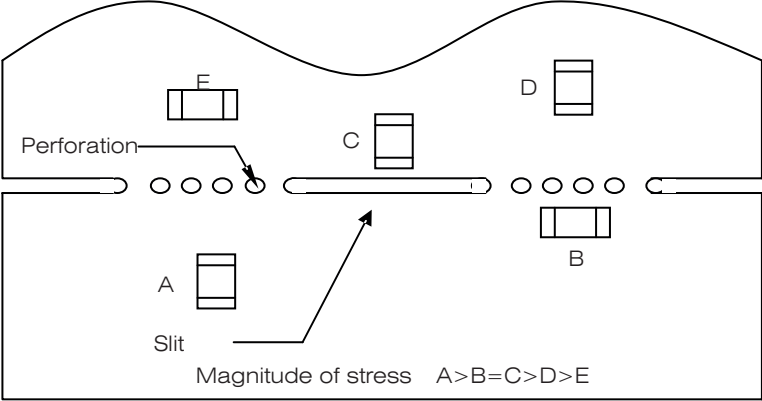

階段	預防	注意事項																					
	<p><b>基板配置</b>                      (電容器在儀器 (分割) PCB板上的安裝設計)</p> <p>將電容器安裝在板上之后, 芯片將承受在下一加工過程中產生的機械應力 (PCB的切割, 板的檢驗、其它部件的安裝, 裝配到底盤、波峰焊接回流焊板, 等)。出于這個原因, 在設計焊盤和 SMD電容器的位置時, 應注意考慮將應力減到最低點。</p>	<p>焊料用量好與差的例子如下:</p> <table border="1" data-bbox="635 347 1452 1120"> <thead> <tr> <th>項目</th> <th>不推薦</th> <th>推薦</th> </tr> </thead> <tbody> <tr> <td>混合安裝 SMD 和引綫元件</td> <td></td> <td></td> </tr> <tr> <td>靠近底盤的元件的安裝</td> <td></td> <td></td> </tr> <tr> <td>在已安裝元件的附近手工焊接引綫元件</td> <td></td> <td></td> </tr> <tr> <td>水平安裝元件</td> <td></td> <td></td> </tr> </tbody> </table> <p>1. 下圖示為電容器在PCB板上布局好壞的例子: PCB板彎曲變形時產生應力, 應將電容器安裝在 PCB板上的受影響最小的位置。</p> <table border="1" data-bbox="635 1254 1436 1456"> <thead> <tr> <th></th> <th>不推薦</th> <th>推薦</th> </tr> </thead> <tbody> <tr> <td>板的變形</td> <td></td> <td></td> </tr> </tbody> </table> <p>2. 電容器安裝在切割PCB板上時, 電容器所受機械應力的由電容器的布局而定。以下為推薦使用的布局方式:</p> <div data-bbox="646 1556 1460 1982">  <p>切割斷孔</p> <p>切割連線</p> <p>應力大小 <math>A &gt; B = C &gt; D &gt; E</math></p> </div>	項目	不推薦	推薦	混合安裝 SMD 和引綫元件			靠近底盤的元件的安裝			在已安裝元件的附近手工焊接引綫元件			水平安裝元件				不推薦	推薦	板的變形		
項目	不推薦	推薦																					
混合安裝 SMD 和引綫元件																							
靠近底盤的元件的安裝																							
在已安裝元件的附近手工焊接引綫元件																							
水平安裝元件																							
	不推薦	推薦																					
板的變形																							

Stages	Precautions	Technical considerations																					
	<p>Pattern configurations (Capacitor layout on panelized [breakaway] PC boards)</p> <p>After capacitors have been mounted on the boards, chips can be subjected to mechanical stresses in subsequent manufacturing processes (PCB cutting, board inspection, mounting of additional parts, assembly into the chassis, wave soldering the reflow-soldering boards etc.). For this reason, planning pattern configurations and the position of SMD capacitors should be carefully performed to minimize stress.</p>	<p>Examples of good and bad solder application.</p> <table border="1" data-bbox="592 360 1361 1021"> <thead> <tr> <th>Items</th> <th>Not recommended</th> <th>Recommended</th> </tr> </thead> <tbody> <tr> <td>Mixed mounting of SMD and leaded components</td> <td></td> <td></td> </tr> <tr> <td>Component placement close to the chassis</td> <td></td> <td></td> </tr> <tr> <td>Hand soldering of leaded components near mounted components</td> <td></td> <td></td> </tr> <tr> <td>Horizontal component placement</td> <td></td> <td></td> </tr> </tbody> </table> <p>1.The following are examples of good and bad capacitor layout: SMD capacitors should be located to minimize any possible mechanical stresses from board warp or deflection.</p> <table border="1" data-bbox="592 1167 1262 1417"> <thead> <tr> <th></th> <th>Not recommended</th> <th>Recommended</th> </tr> </thead> <tbody> <tr> <td>Deflection of the board</td> <td></td> <td></td> </tr> </tbody> </table> <p>2.To layout the capacitors for the breakaway PC board, it should be noted that the amount of mechanics stresses given will vary depending on capacitor layout, The example below shows recommendations for better design.</p>  <p>Magnitude of stress <math>A &gt; B = C &gt; D &gt; E</math></p>	Items	Not recommended	Recommended	Mixed mounting of SMD and leaded components			Component placement close to the chassis			Hand soldering of leaded components near mounted components			Horizontal component placement				Not recommended	Recommended	Deflection of the board		
Items	Not recommended	Recommended																					
Mixed mounting of SMD and leaded components																							
Component placement close to the chassis																							
Hand soldering of leaded components near mounted components																							
Horizontal component placement																							
	Not recommended	Recommended																					
Deflection of the board																							

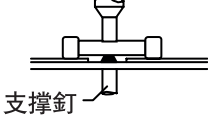
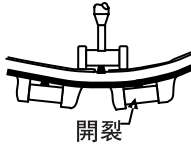
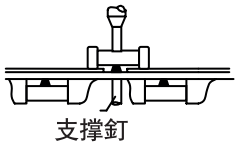

## 多層片式陶瓷電容器

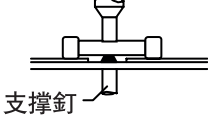
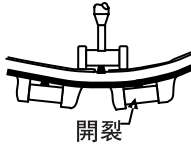
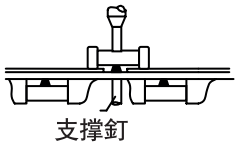
### MULTILAYER CHIP CERAMIC CAPACITOR

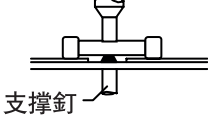
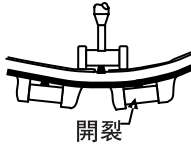
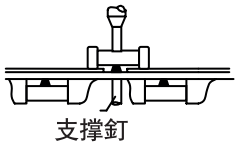
階段	預防	注意事項									
		<p>3.PCB 板沿着接縫孔切割開時，電容器所受機械應力的大小因使用的方法不同而不同。以下方法按應力從小到大進行排列：推板、割裂、V 形凹槽、接縫孔。因此，任何理想的 SMD電容器的布局必須考慮到 PCB板的分割方法。</p>									
<p>3. 自動安裝應考慮到的問題</p>	<p>調節安裝機器： 在將電容器安裝在 PCB板上時，不能讓電容器承受過量的衝擊力。應定期對安裝機器進行維修和檢查。</p>	<p>1. 如果吸拾管降低的位置超過最低限位，就會對電容器產生過大的壓力，從而導致電容器破裂。為了避免上述現象的發生，在降低吸拾管時，要注意以下各點：</p> <ol style="list-style-type: none"> <li>(1) 在校正 PCB板的偏差后，應將吸拾管的最低限位調節到 PCB板的表面水平位置。</li> <li>(2) 吸拾壓力應調節至1到 3N之間。</li> <li>(3) 為了減少吸拾管衝擊力導致 PCB板的變形程度，支撐釘應放在 PCB板的下方。下圖有吸拾管安裝較好的例子。</li> </ol> <table border="1" data-bbox="635 763 1449 1182"> <thead> <tr> <th data-bbox="635 763 882 837"></th> <th data-bbox="882 763 1161 837">不推薦使用</th> <th data-bbox="1161 763 1449 837">推薦使用</th> </tr> </thead> <tbody> <tr> <td data-bbox="635 837 882 1003">單面安裝</td> <td data-bbox="882 837 1161 1003">  </td> <td data-bbox="1161 837 1449 1003">  </td> </tr> <tr> <td data-bbox="635 1003 882 1182">雙面安裝</td> <td data-bbox="882 1003 1161 1182">  </td> <td data-bbox="1161 1003 1449 1182">  </td> </tr> </tbody> </table> <p>2. 如果對位釘磨損，吸管的調整會致使電容器受到機械應力的衝擊而缺口或開裂。為了避免這種現象的發生，在對處於停止狀態下對位釘間寬度和支撐釘進行定期的檢查、維修、檢驗和更換。</p>		不推薦使用	推薦使用	單面安裝			雙面安裝		
	不推薦使用	推薦使用									
單面安裝											
雙面安裝											

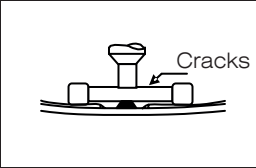
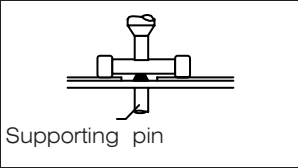
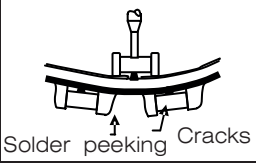
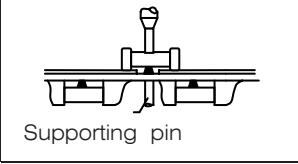
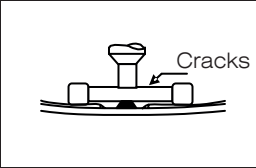
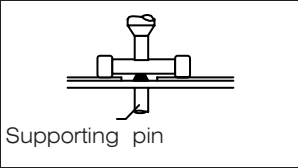
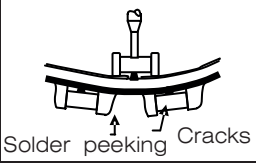
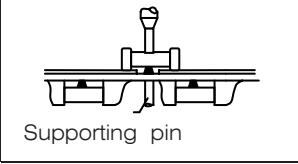
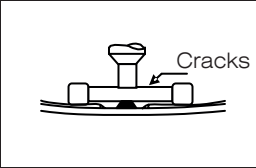
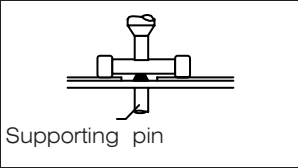
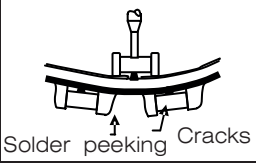
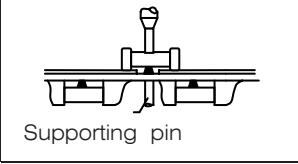
Stages	Precautions	Technical considerations									
		<p>3. When breaking PC boards along their perforations, the amount of mechanical stress on the capacitors can vary according to the method used. The following methods are listed in order from least stressful to most stressful: push-back, slit, V-grooving, and perforation. Thus, any ideal SMD capacitor layout must also consider the PCB splitting method.</p>									
<p>3. Considerations for automatic placement</p>	<p>Adjustment of mounting machine Excessive impact load should not be imposed on the capacitors when mounting onto the PC boards. The maintenance and inspection of the mounting devices must minimize the stresses..</p>	<p>1. If the pick-up nozzle is lower than the low limit, too much force may be imposed on the capacitors, causing damage. To avoid this, the following points should be considered before lowering the pick-up nozzle:</p> <ol style="list-style-type: none"> <li>(1) The lower limit of the pick-up nozzle should be adjusted to the surface level of the PC board after correcting for deflection of the board.</li> <li>(2) The pick-up pressure should be adjusted between 1 and 3 N static loads.</li> <li>(3) To reduce the amount of deflection of the board caused by impact of the pick-up nozzle, supporting pins of back-up should be used the under PC board. The following diagrams show some typical examples of good pick-up nozzle placement:</li> </ol> <table border="1" data-bbox="587 947 1385 1328"> <thead> <tr> <th></th> <th>Not recommended</th> <th>Recommended</th> </tr> </thead> <tbody> <tr> <td>Single-sided mounting</td> <td></td> <td></td> </tr> <tr> <td>Double-sided mounting</td> <td></td> <td></td> </tr> </tbody> </table> <p>2. As the alignment pin wears out, adjustment of the nozzle height can cause chipping or cracking of the capacitors because of mechanical impact on the capacitors. To avoid this, should have periodically inspection, maintenance, repair and change about the alignment pin width and supporting pins, and all this actions should be done under stopped position.</p>		Not recommended	Recommended	Single-sided mounting			Double-sided mounting		
	Not recommended	Recommended									
Single-sided mounting											
Double-sided mounting											

## 多層片式陶瓷電容器

### MULTILAYER CHIP CERAMIC CAPACITOR

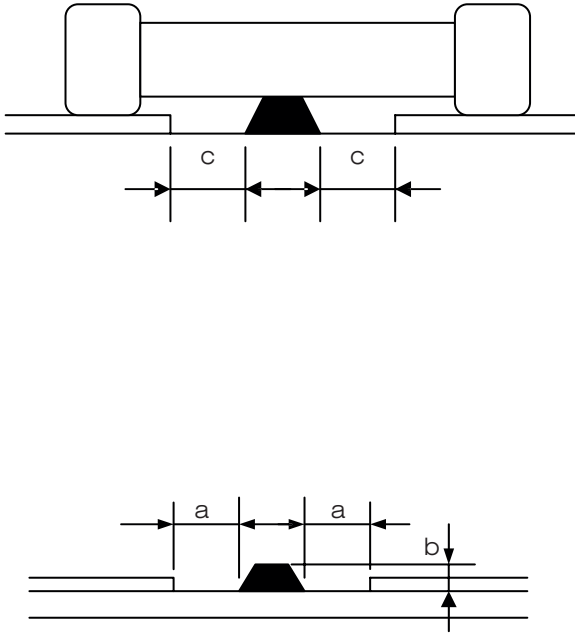
階段	預防	注意事項								
<p>3.自動安裝應考慮到的問題</p>	<p>粘着劑的選用： 在焊接安裝電容器之前，用粘着劑將電容器固定在基板上，這將導致電容器的特性降級，除非對以下因素進行合理的檢查：基板的大小、粘着劑的類型和用量、硬化的溫度和時間。因此，用戶在使用粘着劑時，要注意其用法和用量。</p>	<p>1. 一些粘着劑會減少電容器的絕緣。粘着劑和電容器收縮率的不同會在電容器上產生應力并導致開裂。甚至板上過多或過少的粘着劑會影響元件的安裝。因此在使用粘着劑時應注意以下事項：</p> <p>(1) 要求粘着劑具有的特性：</p> <ol style="list-style-type: none"> <li>在安裝和焊接過程中，粘着劑應有足夠大的力來支撐板上的元件。</li> <li>粘着劑在高溫下要有充足的強度。</li> <li>粘着劑要有很好的粘稠度</li> <li>粘着劑應在其使用期限前使用</li> <li>粘着劑應可快速硬化。</li> <li>粘着劑不能被雜質污染</li> <li>粘着劑要有很好的絕緣特性</li> <li>粘着劑不能有毒或不能發出有毒的氣體。</li> </ol> <table border="1" data-bbox="663 904 1441 1077"> <thead> <tr> <th>序號</th> <th>以 0805/1206 尺寸為例</th> </tr> </thead> <tbody> <tr> <td>a</td> <td>最小 0.3 mm</td> </tr> <tr> <td>b</td> <td>100~120 μm</td> </tr> <tr> <td>c</td> <td>粘着劑不能接觸到焊區</td> </tr> </tbody> </table> <p style="text-align: center;">電容固化后</p> 	序號	以 0805/1206 尺寸為例	a	最小 0.3 mm	b	100~120 μm	c	粘着劑不能接觸到焊區
序號	以 0805/1206 尺寸為例									
a	最小 0.3 mm									
b	100~120 μm									
c	粘着劑不能接觸到焊區									

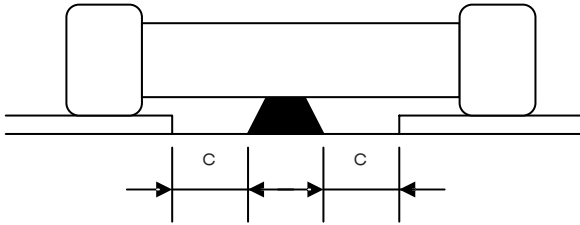
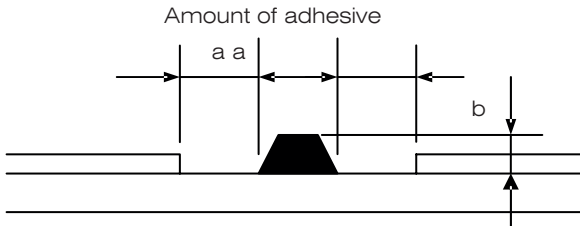
Stages	Precautions	Technical considerations								
<p>3.Considerations for automatic placement</p>	<p>Selection of Adhesives</p> <p>1.Mounting capacitors with adhesives in land patterns, before the soldering stage, may lead to degraded capacitor characteristics unless the following factors are appropriately checked: the size of land patterns, type of adhesive, amount applied, hardening temperature and hardening period. Therefore , users must pay attention to the using method and using amount of adhesives during using the adhesives.</p>	<p>1. .Some adhesives may cause reduced insulation resistance, The difference between the shrinkage percentage of the adhesive and that of the capacitors may result in stresses on the capacitors and lead to cracking. Moreover, too little or too much adhesive applied to the board may adversely affect component placement, so the following precautions should be noted in the application of adhesives.</p> <p>(1) Required adhesive characteristics</p> <ol style="list-style-type: none"> <li>The adhesive should be strong enough to hold parts on the board during the mounting &amp; solder process.</li> <li>The adhesive should have sufficient strength at high temperatures.</li> <li>The adhesive should have good coating and thickness consistency.</li> <li>The adhesive should be used during its prescribed shelf life.</li> <li>The adhesive should harden rapidly.</li> <li>The adhesive must not be contaminated.</li> <li>The adhesive should have excellent insulation characteristics.</li> <li>The adhesive should not be toxic and have no emission of toxic gasses.</li> </ol> <p>2.The recommended amount of adhesives is as follows.</p> <table border="1" data-bbox="635 1151 1345 1323"> <thead> <tr> <th>Figure</th> <th>0805/1206 case sizes as examples</th> </tr> </thead> <tbody> <tr> <td>a</td> <td>0.3 mm min</td> </tr> <tr> <td>b</td> <td>100~120 μm</td> </tr> <tr> <td>c</td> <td>Adhesives should not contact the pad</td> </tr> </tbody> </table> <div style="text-align: center;"> <p>After capacitors are bonded</p>  <p>Amount of adhesive</p>  </div>	Figure	0805/1206 case sizes as examples	a	0.3 mm min	b	100~120 μm	c	Adhesives should not contact the pad
Figure	0805/1206 case sizes as examples									
a	0.3 mm min									
b	100~120 μm									
c	Adhesives should not contact the pad									

## 多層片式陶瓷電容器

### MULTILAYER CHIP CERAMIC CAPACITOR

階段	預防	注意事項					
4. 焊接		<p>1. 活化助焊劑中的鹵化物過多或使用了高酸性的助焊劑，那么焊接后過多的殘留物會腐蝕電容器端頭電極或降解電容器表面的絕緣。</p> <p>2. 流焊接過程中使用助焊劑是爲了增強電容器的可焊性，但如使用過多的助焊劑，助焊劑大量的霧氣會射到電容器上，從而使電容器可焊性受到破壞性的影響。應盡可能減少助焊劑的用量，推薦使用助焊劑氣泡體系。</p> <p>3. 由于溶水性助焊劑的殘留物易溶于空氣中的水，因此高濕條件下電容器表面上的殘留物會導致電容器絕緣下降并影響電容器的可靠性。當選用了溶水性助焊劑時，要特別留意清洗方法和所使用的機器的能力。</p> <p>焊接時的預熱處理：            加熱：在焊接前應對片式陶瓷元件在 100 到 130°C 下預熱。            冷卻：元件和清洗過程中的溫度差異不能大于 100°C。當陶瓷片式電容器曝放在快速或集中致熱或快速致冷的條件下，會受到熱衝擊的影響。因此在焊接過程中要特別注意防止電容器受到過量熱衝擊的影響。</p> <p>推薦使用的焊接方式</p>					
		規格尺寸	溫度特性	額定電壓	容量範圍	焊接方法	
		0201	NPO	/		R	
			X7R	/		R	
			Y5V	/		R	
		0402	NPO	/		R	
			X7R	/		R	
			Y5V	/		R	
		0603	NPO	/		R/W	
			X7R	/	$C \geq 1 \mu F$	R	
					$C < 1 \mu F$	R/W	
			Y5V	/	$C \geq 1 \mu F$	R	
		0805	NPO	/	/	R/W	
					$C \geq 4.7 \mu F$	R	
			X7R	/	$C < 4.7 \mu F$	R/W	
$C \geq 1 \mu F$	R						
1206	NPO	/	/	R/W			
	X7R	/	$C \geq 10 \mu F$	R			
			$C < 10 \mu F$	R/W			
	Y5V	/	$C \geq 10 \mu F$	R			
$\geq 1210$	NPO	/	/	R			
	X7R	/	/	R			
	Y5V	/	/	R			
焊接方式：R—回流焊 W—波峰焊							

Stages	Precautions	Technical considerations																																																																																															
4.Soldering		<p>1. When too much halogenated substance(Chlorine, etc) content is used to activate the flux, or highly acidic flux is used, an excessive amount of residue after soldering may lead to corrosion of the terminal electrodes or degradation of insulation resistance on the surface of the capacitors.</p> <p>2. Flux is used to increase solderability in flow soldering, but if too much flux is applied, a large amount of flux gas may be emitted and may detrimentally affect solderability. To minimize the amount of flux applied, it is recommended to use a flux-bubbling system.</p> <p>3. Since the residue of water-soluble flux is easily dissolved by water content in the air, the residue on the surface of capacitors in high humidity conditions may cause a degradation of insulation resistance and therefore affect the reliability of the components. The cleaning methods and the capability of the machines used should also be considered carefully when selecting water-soluble flux.</p> <p>Preheating when soldering            Heating: Preheat the chips at 100°C to 130 100°Cbefore soldering.            Cooling: The temperature difference between the components and cleaning process should not be greater than 100°C.</p> <p>Ceramic chip capacitors are susceptible to thermal shock when exposed to rapid or concentrated heating or rapid cooling, Therefore, the soldering process must be conducted with great care so as to prevent malfunction of the components due to excessive thermal shock.</p> <p>Recommmended Soldering Method</p> <table border="1" data-bbox="564 1155 1391 1944"> <thead> <tr> <th>Size</th> <th>Temperature Characteristics</th> <th>RatedVoltage</th> <th>Capacitance</th> <th>Soldering Method</th> </tr> </thead> <tbody> <tr> <td rowspan="3">0201</td> <td>NPO</td> <td>/</td> <td></td> <td>R</td> </tr> <tr> <td>X7R</td> <td>/</td> <td></td> <td>R</td> </tr> <tr> <td>Y5V</td> <td>/</td> <td></td> <td>R</td> </tr> <tr> <td rowspan="3">0402</td> <td>NPO</td> <td>/</td> <td></td> <td>R</td> </tr> <tr> <td>X7R</td> <td>/</td> <td></td> <td>R</td> </tr> <tr> <td>Y5V</td> <td>/</td> <td></td> <td>R</td> </tr> <tr> <td rowspan="4">0603</td> <td>NPO</td> <td>/</td> <td></td> <td>R/W</td> </tr> <tr> <td rowspan="2">X7R</td> <td rowspan="2">/</td> <td><math>C \geq 1 \mu F</math></td> <td>R</td> </tr> <tr> <td><math>C &lt; 1 \mu F</math></td> <td>R/W</td> </tr> <tr> <td rowspan="2">Y5V</td> <td rowspan="2">/</td> <td><math>C \geq 1 \mu F</math></td> <td>R</td> </tr> <tr> <td><math>C &lt; 1 \mu F</math></td> <td>R/W</td> </tr> <tr> <td rowspan="4">0805</td> <td>NPO</td> <td>/</td> <td>/</td> <td>R/W</td> </tr> <tr> <td rowspan="2">X7R</td> <td rowspan="2">/</td> <td><math>C \geq 4.7 \mu F</math></td> <td>R</td> </tr> <tr> <td><math>C &lt; 4.7 \mu F</math></td> <td>R/W</td> </tr> <tr> <td rowspan="2">Y5V</td> <td rowspan="2">/</td> <td><math>C \geq 1 \mu F</math></td> <td>R</td> </tr> <tr> <td><math>C &lt; 1 \mu F</math></td> <td>R/W</td> </tr> <tr> <td rowspan="4">1206</td> <td>NPO</td> <td>/</td> <td>/</td> <td>R/W</td> </tr> <tr> <td rowspan="2">X7R</td> <td rowspan="2">/</td> <td><math>C \geq 10 \mu F</math></td> <td>R</td> </tr> <tr> <td><math>C &lt; 10 \mu F</math></td> <td>R/W</td> </tr> <tr> <td rowspan="2">Y5V</td> <td rowspan="2">/</td> <td><math>C \geq 10 \mu F</math></td> <td>R</td> </tr> <tr> <td><math>C &lt; 10 \mu F</math></td> <td>R/W</td> </tr> <tr> <td rowspan="3"><math>\geq 1210</math></td> <td>NPO</td> <td>/</td> <td>/</td> <td>R</td> </tr> <tr> <td>X7R</td> <td>/</td> <td>/</td> <td>R</td> </tr> <tr> <td>Y5V</td> <td>/</td> <td>/</td> <td>R</td> </tr> </tbody> </table> <p>Soldering method: R—Reflow Solering            W—Wave Soldering</p>	Size	Temperature Characteristics	RatedVoltage	Capacitance	Soldering Method	0201	NPO	/		R	X7R	/		R	Y5V	/		R	0402	NPO	/		R	X7R	/		R	Y5V	/		R	0603	NPO	/		R/W	X7R	/	$C \geq 1 \mu F$	R	$C < 1 \mu F$	R/W	Y5V	/	$C \geq 1 \mu F$	R	$C < 1 \mu F$	R/W	0805	NPO	/	/	R/W	X7R	/	$C \geq 4.7 \mu F$	R	$C < 4.7 \mu F$	R/W	Y5V	/	$C \geq 1 \mu F$	R	$C < 1 \mu F$	R/W	1206	NPO	/	/	R/W	X7R	/	$C \geq 10 \mu F$	R	$C < 10 \mu F$	R/W	Y5V	/	$C \geq 10 \mu F$	R	$C < 10 \mu F$	R/W	$\geq 1210$	NPO	/	/	R	X7R	/	/	R	Y5V	/	/	R
Size	Temperature Characteristics	RatedVoltage	Capacitance	Soldering Method																																																																																													
0201	NPO	/		R																																																																																													
	X7R	/		R																																																																																													
	Y5V	/		R																																																																																													
0402	NPO	/		R																																																																																													
	X7R	/		R																																																																																													
	Y5V	/		R																																																																																													
0603	NPO	/		R/W																																																																																													
	X7R	/	$C \geq 1 \mu F$	R																																																																																													
			$C < 1 \mu F$	R/W																																																																																													
	Y5V	/	$C \geq 1 \mu F$	R																																																																																													
$C < 1 \mu F$			R/W																																																																																														
0805	NPO	/	/	R/W																																																																																													
	X7R	/	$C \geq 4.7 \mu F$	R																																																																																													
			$C < 4.7 \mu F$	R/W																																																																																													
	Y5V	/	$C \geq 1 \mu F$	R																																																																																													
$C < 1 \mu F$			R/W																																																																																														
1206	NPO	/	/	R/W																																																																																													
	X7R	/	$C \geq 10 \mu F$	R																																																																																													
			$C < 10 \mu F$	R/W																																																																																													
	Y5V	/	$C \geq 10 \mu F$	R																																																																																													
$C < 10 \mu F$			R/W																																																																																														
$\geq 1210$	NPO	/	/	R																																																																																													
	X7R	/	/	R																																																																																													
	Y5V	/	/	R																																																																																													

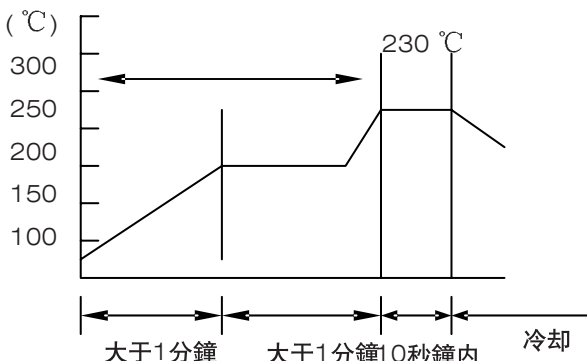
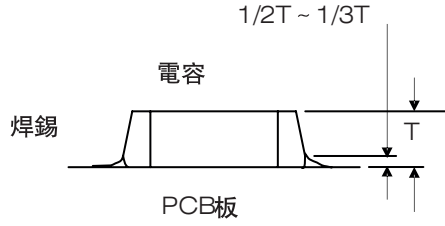
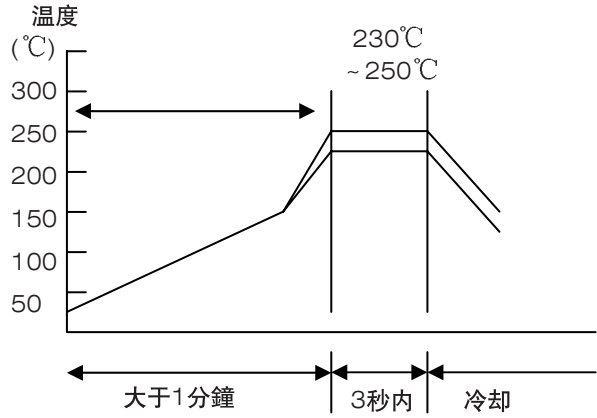
階段	預防	
4. 焊接		<p>推薦使用的焊接條件: [回流焊接] (溫度曲線)</p> <p>溫度 (°C)</p>  <p>警告:</p> <p>1. 理想的焊料量應為電容器厚度的1/2 或 1/3 , 如下圖所示:</p>  <p>注意事項</p> <p>太長的浸焊料時間會損壞電容器的可焊性，因此焊接時間應盡可能接近所推薦的時間。</p> <p>[波峰焊接] 溫度曲線</p> <p>溫度 (°C)</p>  <p>警告:</p> <ol style="list-style-type: none"> <li>1. 確保電容器已經預熱充分。</li> <li>2. 電容器和熔化的焊料之間的溫度之差不能大于100到130°C</li> <li>3. 焊接后的冷卻方法應盡可能是自然冷卻</li> <li>4. 指定僅可用回流焊接的電容器不能用波峰焊接。</li> </ol>

Stages	Precautions	Technical considerations
4. Soldering		<p>Recommended conditions for soldering [Re-flow soldering]</p> <p>Temperature profile</p> <p>Cautions</p> <ol style="list-style-type: none"> <li>1. The ideal condition is to have solder mass (fillet) controlled to 1/2 to 1/3 of the thickness of the capacitor, as shown below</li> </ol> <p>Because excessive dwell times can detrimentally affect solderability, soldering duration should be kept as close to recommended times as possible.</p> <p>[Wave soldering]</p> <p>Temperature profile</p> <p>Cautions</p> <ol style="list-style-type: none"> <li>1. Make sure the capacitors are preheated sufficiently.</li> <li>2. The temperature difference between the capacitor and melted solder should not be greater than 100 to 130°C.</li> <li>3. Cooling after soldering should be as gradual as possible.</li> <li>4. Wave soldering must not be applied to the capacitors designated as for reflow soldering only.</li> </ol>



## 多層片式陶瓷電容器

### MULTILAYER CHIP CERAMIC CAPACITOR

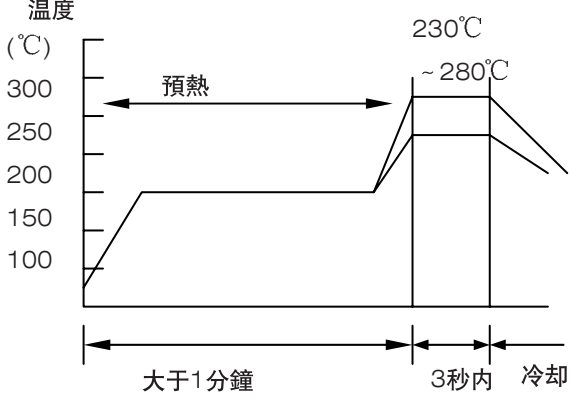
階段	預防	注意事項
		<p>[手工焊接]</p> <p>溫度曲線</p>  <p>警告:</p> <ol style="list-style-type: none"> <li>1. 使用的烙鐵的尖頂的直徑最大為 1.0mm。</li> <li>2. 烙鐵不能直接碰到電容器上。</li> </ol>
5. 清洗	<p>清洗條件:</p> <ol style="list-style-type: none"> <li>1. 在安裝完所有的電容器，在清洗PCB板時，應根據所使用的助焊劑和清洗的目的（如為了除掉焊接時殘留的助焊劑還是生產過程中的其他材料）來選擇適當的清洗溶劑。</li> <li>2. 應對清洗條件進行核對并取人清洗過程不電容器的特性影響</li> </ol>	<ol style="list-style-type: none"> <li>1. 如果使用不恰當的溶劑，會使其它物質如助焊劑殘留物粘到電容器或破壞電容器的外部塗層，從而導致電容器的電性能下降（特別是絕緣）。</li> <li>2. 不恰當的清洗條件（清洗不够，或過渡清洗）會破壞電容器的電性能。             <p>(1) 過渡清洗:</p> <p>在用超聲波清洗的情況下，輸出的能源太大則會使PCB板承受過量的振動，這會導致電容或焊接點開裂，或降低端電極強度。因此要特別注意以下檢查條件:</p> <p>超聲波輸出: 低于 20W/L              超聲波頻率: 低于 40KHz              超聲波清洗時間: 5分鐘或更少</p> </li> </ol>

Stages	Precautions	Technical considerations
		<p>[Hand soldering]</p> <p style="text-align: center;">Temperature profile</p> <p>Temperature (°C)</p> <p>300 250 200 150 100</p> <p>Preheating</p> <p>230°C ~ 250°C</p> <p>Over 1 minute</p> <p>Within 3s</p> <p>Gradual cooling</p> <p>Caution</p> <ol style="list-style-type: none"> <li>Use soldering iron with a maximum tip diameter of 1.0 mm. The soldering iron should not directly touch the capacitor. [Wave soldering]</li> </ol>
5. Cleaning	<p>Cleaning conditions</p> <ol style="list-style-type: none"> <li>When cleaning the PC board after the Capacitors are all mounted, select the appropriate cleaning solution according to the type of flux used and purpose of the cleaning (e. g. to remove soldering flux or other materials from the production process.)</li> <li>Cleaning conditions should be determined after verifying. Make sure that the cleaning process does not affect the capacitors characteristics.</li> </ol>	<ol style="list-style-type: none"> <li>The use of inappropriate solutions can cause foreign substances such as flux residue to adhere to the capacitor or deteriorate the capacitor's outer coating, resulting in a degradation of the capacitor's electrical (especially insulation resistance).</li> <li>Inappropriate cleaning conditions (insufficient or excessive cleaning) may detrimentally affect the performance of the capacitors.             <ol style="list-style-type: none"> <li>Excessive cleaning</li> </ol> <p>In the case of ultrasonic cleaning, too much power output can cause excessive vibration of the PC board which may lead to the cracking of the capacitor or the soldered portion, or decrease the terminal electrodes, strength, thus the following conditions should be carefully checked;</p> <p>Ultrasonic output Below 20W/L Ultrasonic frequency Below 40KHZ Ultrasonic washing period 5min or less</p> </li> </ol>

## 多層片式陶瓷電容器

### MULTILAYER CHIP CERAMIC CAPACITOR

階段	預防	注意事項
6. 清洗后處理工作	<p>一些樹脂含有腐蝕性氣體或化學反應氣體會保留在樹脂中，在硬化期或在正常儲存溫度下，均會影響破壞電容器的性能。</p> <p>當樹脂硬化的溫度高于電容器的運行溫度時，大量的熱會產生應力從而導致電容器受到損壞或破壞。因此不能推薦使用此類樹脂、熔化材料等。</p>	
7. 處理	<p>切割PCB板（沿着接縫孔分割開）</p> <ol style="list-style-type: none"> <li>1. 在安裝完電容器和其它元件后，分割PCB板時，注意不能在板上施加任何力。</li> <li>2. 板的分割不能用手工分割，應使用合適的設備</li> </ol>	<p>機械方面應注意的事項：</p> <p>注意不能主電容器承受過量的機械衝擊</p> <p>（1）如果電容器掉在地上或掉在硬物上，則不能再使用這些電容器。</p> <p>（2）在處理安裝板時，注意安裝元件不能碰到或撞到其他板或元件上。</p>
8. 儲存條件	<p>儲存</p> <ol style="list-style-type: none"> <li>1. 為了保持端電極的可焊性和保證包裝材料處於良好的條件狀態，要注意監控好電容器儲存區域的溫度和濕度控制。</li> </ol> <p>推薦的條件： 溫度：0~40℃ 濕度：低於70%</p> <p>室溫必須低於40℃。但即使在理想儲存條件下存放，電容器端頭可焊性也會隨着時間的推移而下降，因此電容器應在發貨之日算起6個月內使用。</p> <p>包裝材料應存放在不含氯或硫的空氣中。</p> <ol style="list-style-type: none"> <li>2. 高介電常數的電容器的容量值將隨着時間的推移而下降，因此在設計電路時要考慮到這一點。如果電容器的容量值減少了，在150℃的條件下對電容器進行預熱，那麼電容器的容量值會恢復到初始值。</li> </ol>	<p>如果將電容器存放在高溫和高濕的環境下，電容器的端電極就會被氧化，從而導致其可焊性下降；另外，在這種儲存條件下，電容器的編帶/包裝材料會受到破壞。出于這個原因，電容器應在自發貨之日算起6個月內使用。如果超出了這個期限，在使用電容器之前要對其可焊性進行檢驗。</p>

Stages	Precautions	Technical considerations
6. Post cleaning Processes	<p>With some type of resins a decomposition gas or chemical reaction vapor may remain inside the resin during the hardening period or even while left under normal storage conditions will result in the deterioration of the capacitor ' s performance.</p> <p>1. When a resin ' s hardening temperature is higher than the capacitor ' s operating temperature. The stresses generated by the excess heat may lead to capacitor damage or destruction. The use of such resins molding materials is not recommended.</p>	
7. Handling	<p>Breakaway PC boards (splitting along perforations)</p> <p>1. When splitting the PC board after mounting capacitors and other components, care is required so as not to give any stresses of twisting to board.</p> <p>2. Board separation should not be done manually, but by using the appropriate devices.</p>	<p>Mechanical considerations</p> <p>1. Be careful not to subject the capacitors to excessive mechanical shocks.</p> <p>(1) If ceramic capacitors are dropped onto the floor or a hard surface, they should not be used.</p> <p>(2) When handling the mounted boards, be careful that the mounted components do not come in contact with or bump against other boards or components.</p>
8. Storage Conditions	<p>Storage</p> <p>1. To maintain the solderability of terminal electrodes and to keep the packaging material in good condition, care must be taken to control temperature and humidity in the storage area. Humidity should especially be kept as low as possible.</p> <p>※Recommended conditions</p> <p>Temperature      0~40℃</p> <p>Humidity            Below 70% RH</p> <p>※The room temperature must below 40℃. Even under ideal storage conditions capacitor electrode solderability decreased as time passes, so ceramic chip capacitors should be used within 6 months from the time of delivery.</p> <p>※The packaging material should be kept where nochlorine or sulfur exist in the air.</p> <p>2. The capacitance value of high dielectric constant capacitors (type 2&amp;3) will gradually decrease with the Passage of time, so this should be taken into consideration in the circuit design. If such a capacitance reduction occurs, a heat treatment of 150℃ for 1 hour will return the capacitance to its initial level.</p>	<p>1. If the parts are stored in a high temperature and humidity environment, problems such as reduced solderability caused by oxidation of terminal electrodes and deterioration of taping/package materials may take place. For this reason, components should be used within 6 months from the rime of delivery. If exceeding the above period, please check solderability before using the capacitors.</p>

## X-ON Electronics

Largest Supplier of Electrical and Electronic Components

*Click to view similar products for [Multilayer Ceramic Capacitors MLCC - SMD/SMT](#) category:*

*Click to view products by [Fenghua Advanced](#) manufacturer:*

Other Similar products are found below :

[M39014/02-1225V](#) [M39014/22-0631](#) [D55342E07B523DR-T/R](#) [NCA1206X7R103K50TRPF](#) [NIN-FB391JTRF](#) [NIN-FC2R7JTRF](#)  
[NMC0402NPO220J50TRPF](#) [NMC0402X5R105K6.3TRPF](#) [NMC0402X5R224K6.3TRPF](#) [NMC0402X7R103J25TRPF](#)  
[NMC0402X7R392K50TRPF](#) [NMC0603NPO201J50TRPF](#) [NMC0603NPO330G50TRPF](#) [NMC0603NPO331F50TRPF](#)  
[NMC0603X5R475M6.3TRPF](#) [NMC0603X7R333K16TRPF](#) [NMC0805NPO220J100TRPF](#) [NMC0805NPO820J50TRPF](#)  
[NMC1206X7R102K50TRPF](#) [NMC1206X7R106K10TRPLPF](#) [NMC-H0805X7R472K250TRPF](#) [C1608C0G2A221J](#) [C1608X7R1E334K](#)  
[C2012C0G2A472J](#) [2220J2K00562KXT](#) [CCR06CG153FSV](#) [CDR33BX104AKUR](#) [CDR33BX683AKUS](#) [CGA3E1X7R1C684K](#)  
[CL10C0R8BB8ANNC](#) [M55342H06B20G0R-T/R](#) [C1005X5R0G225M](#) [C2012X7R2E223K](#) [C3216C0G2J272J](#) [D55342E07B35E7R-T/R](#)  
[CDR34BX563BKUS](#) [CDR34BX563BKWS](#) [NMC0402NPO220F50TRPF](#) [NMC0402X7R562J25TRPF](#) [NMC0603NPO102J25TRPF](#)  
[NMC1206X7R332K50TRPF](#) [NMC-P1206X7R104K250TRPLPF](#) [726632-1](#) [CGA6M3X7R1H225K](#) [CGA5L2X7R2A105K](#)  
[CGA3E2X8R1H223K](#) [CDR33BX823AKUR\M500](#) [CDR33BP132BJUR](#) [CDR35BX474AKUR\M500](#) [CDR35BX104BKUR\M500](#)