



风华高科

广东风华高新科技股份有限公司

FENGHUA

Fenghua Advanced Technology (Holding) CO., LTD

一、概述

电容器及介质种类：

高频类：此类介质材料的电容器为 类电容器，包括通用型高频 COG、COH 电容器和温度补偿型高频 HG、LG、PH、RH、SH、TH、UJ、SL 电容器。其中 COG、COH 电容器电性能最稳定，几乎不随温度、电压和时间的变化而变化，适用于低损耗，稳定性要求高的高频电路，HG、LG、PH、RH、SH、TH、UJ、SL 电容器容量随温度变化而相应变化，适用于低损耗、温度补偿型电路中。

X7R、X5R、X7S、X6S：此类介质材料的电容器为 类电容器，具有较高的介电常数，容量比 类电容器高，具有较稳定的温度特性，适用于容量范围广，稳定性要求不高的电路中，如隔直、耦合、旁路、鉴频等电路中。

Y5V：此类介质材料的电容器为 类电容器，是所有电容器中介电常数最大的电容器，但其容量稳定性较差，对温度、电压等条件较敏感，适用于要求大容量，温度变化不大的电路中。

Z5U：此类介质材料的电容器为 类电容器，其温度特性介于 X7R 和 Y5V 之间，容量稳定性较差，对温度、电压等条件较敏感，适用于要求大容量，使用温度范围接近于室温的旁路，耦合等，低直流偏压的电路中。

SUMMARY

Types of Dielectric Material and Capacitor

HIGH FREQUENCY TYPE: The capacitor of this kind dielectric material is considered as Class capacitor, including high frequency COG、COH capacitor and temperature compensating capacitor such as HG, LG, PH, RH,SH, TH, UJ, SL. The electrical properties of COG、COH capacitor are the most stable one and change invariably with temperature, voltage and time. They are suited for applications where low-losses and high-stability are required, HG LG PH RH SH TH UJ SL capacitor's capacitance changes with temperature. They are suited for applications where low-losses and temperature compensating circuits.

X7R、X5R、X7S、X6S :X7R、X5R、 X7S、X6S material is a kind of material has high dielectric constant. The capacitor made of this kind material is considered as Class capacitor whose capacitance is higher than that of class . These capacitors are classified as having a semi-stable temperature characteristic and used over a wide temperature range, such in these kinds of circuits, DC-blocking, decoupling, bypassing, frequency discriminating etc.

Y5V：The capacitor made of this kind of material is the highest dielectric constant of all ceramic capacitors. They are used over a moderate temperature range in application where high capacitance is required because of its unstable temperature coefficient, but where moderate losses and capacitance changes can be tolerated. Its capacitance and dissipation factors are sensible to measuring conditions, such as temperature and voltage, etc.

Z5U :The capacitor made of this kind of material is considered as Class capacitor, whose temperature characteristic is between that of X7R and Y5V. The capacitance of this kind of capacitor is unstable and sensible to temperature and voltage. Ideally suited for bypassing and decoupling application circuits operating with low DC bias in the environment approaches to room temperature.



二、尺寸及结构 DIMENSIONS AND STRUCTURE

尺寸 DIMENSIONS

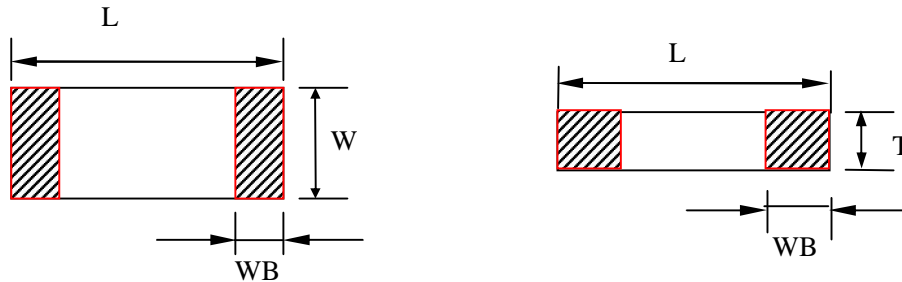

型号 Type		尺寸 Dimensions (mm)			
英制表示 British expression	公制表示 Metric expression	L	W	T	WB
0201	0603	0.6 ± 0.03	0.3 ± 0.03	0.3 ± 0.03	0.15 ± 0.10
0402	1005	1.00 ± 0.05	0.50 ± 0.05	0.50 ± 0.05	0.25 ± 0.10
0603	1608	1.60 ± 0.10	0.80 ± 0.10	0.80 ± 0.10	0.30 ± 0.10
0805	2012	2.00 ± 0.20	1.25 ± 0.20	0.55	0.50 ± 0.20
				0.80 ± 0.20	
				1.00 ± 0.20	
				1.25 ± 0.20	
1206	3216	3.20 ± 0.30	1.60 ± 0.30	0.80 ± 0.20	0.60 ± 0.30
				1.00 ± 0.20	
				1.25 ± 0.20	
				1.60 ± 0.30	
1210	3225	3.20 ± 0.30	2.50 ± 0.30	2.80	0.60 ± 0.30
1808	4520	4.50 ± 0.40	2.00 ± 0.20	2.20	0.60 ± 0.30
1812	4532	4.50 ± 0.40	3.20 ± 0.30	3.50	0.60 ± 0.30
2220	5750	5.70 ± 0.40	5.00 ± 0.40	3.50	0.60 ± 0.30
2225	5763	5.70 ± 0.50	6.30 ± 0.50	6.20	0.60 ± 0.30
3012	7632	7.60 ± 0.50	3.20 ± 0.30	8.10	0.60 ± 0.30
3035	7690	7.60 ± 0.50	9.00 ± 0.50	8.10	0.60 ± 0.30

备注：可根据客户的特殊要求设计符合客户需求的产品。

Note: We can design according to customer special requirements

结构 STRUCTURE

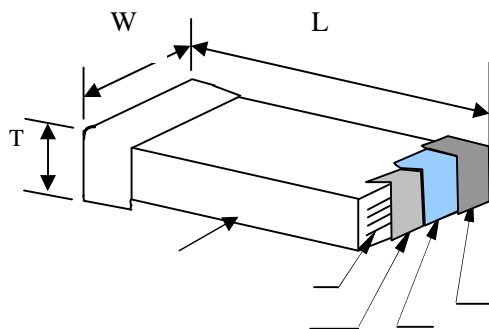

序号 NO	名称 Name
	陶瓷介质 Ceramic dielectric
	内电极 Inner electrode
	外电极 Substrate electrode
	镍层 Nickel Layer
	锡层 Tin Layer



三、型号规格表示方法 HOW TO ORDER

0805 CG 101 J 500 N T

说明 NOTES :

尺寸 DIMENSIONS

尺寸规格 Size Code	0201	0402	0603	0805	1206	1210	1808	1812	2220	2225	3035
长×宽 (L×W) inch	002×001	004×002	006×003	008×005	012×006	012×010	018×008	018×012	022×020	022×025	030×035
长×宽 (L×W) mm	0.60×0.30	1.00×0.50	1.60×0.80	2.00×1.25	3.20×1.60	3.20×2.50	4.50×2.00	4.50×3.20	5.70×5.00	5.70×6.30	7.60×9.00

介质种类 DIELECTRIC STYLE

介质种类 (Dielectric Code)	CG	CH	HG	LG	PH	RH	SH	TH	UJ	SL	X	B	BS	DS	E	F
介质材料 (Dielectric)	CO G	CO H	HG	LG	PH	RH	SH	TH	UJ	SL	X5 R	X7 R	X7 S	X6 S	Z5 U	Y5 V

标称容量 NOMINAL CAPACITANCE

单位(unit) : pF

表示方式 (Express Method)	实际值 (Actual Value)	注：头两位数字为有效数字，第三位数字为0的个数；R为小数点。 Note: the first two digits are significant; third digit denotes number of zeros; R=decimal point.
0R5	0.5	
1R0	1.0	
102	10 × 10 ²	
224	22 × 10 ⁴	
...	...	

容量误差 CAPACITANCE TOLERANCE

代码 (Code)	A	B	C	D	F	G	J	K	M	S	Z
误差 (Tolerance)	± 0.05pF	± 0.10pF	± 0.25pF	± 0.5pF	± 1.0%	± 2.0%	± 5.0%	±10%	±20%	+50% -20%	+80% -20%

备注：A、B、C、D级误差适用于容量 10pF 的产品。

Note :These capacitance tolerance A ,B, C, D are just applicable the capacitance that equals to or less than 10pF.



额定电压 RATED VOLTAGE

单位(unit) : V

表示方式 (Express Method)	实际值 (Actual Value)	注 :头两位数字为有效数字 ,第三位数字为 0 的个数 ; R 为小数点。 Note: the first two digits are significant; third digit denotes number of zeros; R=decimal point.
6R3	6.3	
500	50×10^0	
201	20×10^1	
102	10×10^2	
...	...	

端头材料 TERMINAL MATERIAL STYLES

端头类别 (Termination Styles)	表示方式 (Express Method)
纯银端头 (Silver Solderable Termination)	S
纯铜端头 (Copper Solderable Termination)	C
三层电镀端头 (Nickel Barrier Termination)	N

包装方式 PACKAGE STYLES

B	T
散包装 (Bulk Bag)	编带包装 (Taping Package)

四、温度系数/特性 Temperature Coefficient /Characteristics

介质种类 Dielectric	参考温度点 Reference Temperature Point	标称温度系数 Temperature Coefficient	工作温度范围 Operation Temperature Range
COG	20°C	0±30 ppm/	-55 ~ 125
COH	20°C	0±60 ppm/	-55 ~ 125
HG	20°C	-33±30 ppm/	-25 ~ 85
LG	20°C	-75±30 ppm/	-25 ~ 85
PH	20°C	-150± 60 ppm/	-25 ~ 85
RH	20°C	-220± 60 ppm/	-25 ~ 85
SH	20°C	-330± 60 ppm/	-25 ~ 85
TH	20°C	-470± 60 ppm/	-25 ~ 85
UJ	20°C	-750± 120 ppm/	-25 ~ 85
SL	20°C	-1000 ~ +140 ppm/	-25 ~ 85
X7R	20°C	±15%	-55 ~ 125
X5R	20°C	±15%	-55 ~ 85
X7S	20°C	±22%	-55 ~ 125
X6S	20°C	±22%	-55 ~ 105
Z5U	20°C	-56% ~ +22%	10 ~ 85
Y5V	20°C	-80% ~ +30%	-25 ~ 85

备注： 类电容器标称温度系数和允许偏差是采用温度在 20°C 和 85°C 之间的电容量变化来确定的，而 类电容器标称温度系数是按照工作范围之间的电容量相对 20°C 的电容量变化来确定的。

Note : Nominal temperature coefficient and allowed tolerance of class are decided by the changing of the capacitance between 20°C and 85°C. Nominal temperature coefficient of class are decided by the temperature of 20°C.



五、容量范围及其电压 Capacitance Range and Operating Voltage

尺寸规格 Size Code	额定电压 Rated Voltage	容量范围 Capacitance	
		COG(NPO)(PF)	Y5V (Z5U)(PF)
0201	4V	—	—
	6.3V	—	10,000 ~ 100,000
	10V	—	—
	16V	—	10,000
	25V	—	—
	50V	0.5 ~ 100	—
0402	4V	—	—
	6.3V	—	1,000 ~ 1,000,000
	10V	—	1,000 ~ 1,000,000
	16V	—	1,000 ~ 220,000
	25V	—	1,000 ~ 220,000
	50V	0.1 ~ 1,000	1,000 ~ 100,000
0603	4V	—	—
	6.3V	—	1,000 ~ 10,000,000
	10V	—	1,000 ~ 10,000,000
	16V	—	1,000 ~ 2,200,000
	25V	—	1,000 ~ 2,200,000
	50V	0.1 ~ 6,800	1,000 ~ 1,000,000
0805	4V	—	—
	6.3V	—	1,000 ~ 22,000,000
	10V	—	1,000 ~ 22,000,000
	16V	—	1,000 ~ 22,000,000
	25V	—	1,000 ~ 10,000,000
	50V	0.3 ~ 22,000	1,000 ~ 4,700,000



尺寸规格 Size Code	额定电压 Rated Voltage	容量范围 Capacitance	
		COG(NPO)(PF)	Y5V (Z5U)(PF)
1206	4V	—	—
	6.3V	—	1,000 ~ 47,000,000
	10V	—	1,000 ~ 47,000,000
	16V	—	1,000 ~ 47,000,000
	25V	—	1,000 ~ 10,000,000
	50V	0.3 ~ 100,000	1,000 ~ 10,000,000
1210	6.3V	—	4,700 ~ 100,000,000
	10V	—	4,700 ~ 47,000,000
	16V	—	4,700 ~ 22,000,000
	25V	—	4,700 ~ 10,000,000
	50V	10 ~ 100,000	4,700 ~ 10,000,000
1808	6.3V	—	—
	10V	—	—
	16V	—	—
	25V	—	—
	50V	10 ~ 100,000	—
1812	6.3V	—	10,000 ~ 100,000,000
	10V	—	10,000 ~ 100,000,000
	16V	—	10,000 ~ 22,000,000
	25V	—	10,000 ~ 10,000,000
	50V	10 ~ 100,000	10,000 ~ 10,000,000



尺寸规格 Size Code	额定电压 Rated Voltage	容量范围 Capacitance			
		X7R (PF)	X7S(PF)	X5R(uF)	X6S(uF)
0201	4V	—	—	0.015 uF ~ 1uF	—
	6.3V	—	—	0.015 uF ~ 1uF	—
	10V	100 ~ 10,000	—	0.015 uF ~ 0.1 uF	—
	16V	100 ~ 10,000	—	—	—
	25V	100 ~ 10,000	—	—	—
	50V	—	—	—	—
0402	4V	—	—	0.1uF~10uF	0.1~2.2 uF
	6.3V	100 ~ 470,000	100,000 ~ 470,000	0.1uF~4.7uF	0.1~2.2 uF
	10V	100 ~ 470,000	100,000 ~ 470,000	0.1uF~4.7uF	0.1~1 uF
	16V	100 ~ 220,000	47,000 ~ 220,000	0.1uF~2.2 uF	—
	25V	100 ~ 100,000	22,000 ~ 100,000	0.1uF~2.2 uF	—
	50V	100 ~ 100,000	4,700 ~ 100,000	0.047uF~0.1 uF	—
0603	4V	—	—	0.47uF ~ 22uF	0.1~10 uF
	6.3V	150 ~ 2,200,000	470,000 ~ 2,200,000	0.47uF ~ 22uF	0.1~10 uF
	10V	150 ~ 2,200,000	470,000 ~ 2,200,000	0.47uF ~ 10uF	0.1~10 uF
	16V	150 ~ 1,000,000	470,000 ~ 1,000,000	0.47uF ~ 10uF	0.1~4.7 uF
	25V	150 ~ 1,000,000	470,000 ~ 1,000,000	0.47uF ~ 10uF	0.1~4.7 uF
	50V	150 ~ 470,000	—	0.47uF ~ 1uF	—
0805	4V	—	—	1uF ~ 47uF	0.1~47 uF
	6.3V	150 ~ 10,000,000	1,000,000 ~ 10,000,000	1uF ~ 47uF	0.1~22 uF
	10V	150 ~ 10,000,000	1,000,000 ~ 10,000,000	1uF ~ 22uF	0.1~10 uF
	16V	150 ~ 4,700,000	1,000,000 ~ 4,700,000	1uF ~ 22uF	0.1~10 uF
	25V	150 ~ 4,700,000	1,000,000 ~ 4,700,000	1uF ~ 10uF	0.1~10 uF
	50V	150 ~ 1,000,000	—	—	—



尺寸规格 Size Code	额定电压 Rated Voltage	容量范围 Capacitance			
		X7R (PF)	X7S (PF)	X5R(uF)	X6S(uF)
1206	4V	—	—	2.2uF ~ 100uF	—
	6.3V	200 ~ 22,000,000	2,200,000 ~ 22,000,000	2.2uF ~ 100uF	0.1~100 uF
	10V	200 ~ 22,000,000	2,200,000 ~ 22,000,000	2.2uF ~ 47uF	0.1~22 uF
	16V	200 ~ 10,000,000	2,200,000 ~ 10,000,000	2.2uF ~ 22uF	0.1~22 uF
	25V	200 ~ 10,000,000	1,500,000 ~ 10,000,000	2.2uF ~ 22uF	0.1~10 uF
	50V	200 ~ 4,700,000	1,000,000 ~ 4,700,000	2.2uF ~ 10uF	—
1210	6.3V	220 ~ 47,000,000	—	47uF ~ 100uF	0.1~100 uF
	10V	220 ~ 47,000,000	—	4.7uF ~ 100uF	0.1~47 uF
	16V	220 ~ 22,000,000	3,300,000 ~ 22,000,000	4.7uF ~ 47uF	0.1~22 uF
	25V	220 ~ 22,000,000	2,200,000 ~ 22,000,000	4.7uF ~ 22uF	0.1~22 uF
	50V	220 ~ 10,000,000	1,000,000 ~ 10,000,000	—	—
1808	6.3V	220 ~ 4,700,000	—	4.7uF ~ 100uF	—
	10V	220 ~ 4,700,000	—	4.7uF ~ 47uF	—
	16V	220 ~ 4,700,000	—	4.7uF ~ 22uF	—
	25V	220 ~ 4,700,000	—	4.7uF ~ 10uF	—
	50V	220 ~ 4,700,000	—	—	—
1812	6.3V	—	—	10uF ~ 100uF	—
	10V	—	—	10uF ~ 47uF	—
	16V	470 ~ 6,800,000	—	4.7uF ~ 22uF	—
	25V	470 ~ 6,800,000	—	4.7uF ~ 10uF	—
	50V	470 ~ 4,700,000	—	—	—

备注：可根据客户的特殊要求设计符合客户需求的产品。

Note：We can design according to customer special requirements .



六、高 Q 值 COG 电容器 Hi-Q COG MLCC

应用:

适合于射频 RF 电路及要求 Hi-Q、低 ESR、高频率响应的微波电路中。

CQ、CG 电容器说明：

下述 Q 值标准是相对通用客户而制定的，对要求更高 Q 值产品的客户，可专门设计和生产。

使用频率在 1MHz~2.4GHz 之间，对要求更高频率产品的客户，可根据客户的要求另外专门设计。

CQ 比 CG 相对可应用频率略高,请客户按需选定。

Application:

Hi-Q COG capacitors are ideally suited for RF and microwave application requiring high Q, low ESR, and high resonant frequency.

Note for CQ and CG:

The following Q value is just confirmed by general customer. If there is a higher requirement for Q value requirements, we can design and produce according to the special requirements.

For the customer whose requirements for frequency is between 1MHz and 2.4GHz or higher frequency, we can design it according to their requirements.

The frequency of CQ is a little higher than that of CG. Please choose them according to your requirements.

CQ 电容器的容量值及其 Q 值 CQ Capacitance value and Q value

容量 Capacitance (pF)	300MHz 时的Q 值 Q value at 300MHz		容量 Capacitance (pF)	300MHz 时的Q 值 Q value at 300MHz		容量 Capacitance (pF)	300MHz 时的Q 值 Q value at 300MHz	
	0805	0603		0805	0603		0805	0603
	4.7	1000		800	12		400	320
5.2	900	720	13	375	300	33	140	112
5.6	850	680	14	350	280	36	130	104
6.2	800	640	15	325	260	39	120	96
6.8	700	560	16	300	240	43	110	88
7.5	650	520	18	250	200	47	100	80
8.2	575	460	20	225	180	56	80	80
9.1	525	420	22	215	172	62	80	80
10	500	400	24	200	160	68	80	80
11	450	360	27	175	140	82	80	80



七、中高压电容器 HIGH VOLTAGE MLCC

中高压多层片状陶瓷电容器是在多层片状陶瓷电容器的工艺技术、设备基础上，通过采用特殊工艺制作的一种具有良好高压可靠性的产品，该产品适合于表面贴装，适合于多种直流高压线路，可以有效的改善电子线路的性能。

应用范围

- 模拟或数字调制解调器。
- 局域网/广域网接口界面。
- 日光灯启动辉器照明电路。
- 倍压电器。
- 直流变速器。
- 背光源驱动电路。

Middle & high voltage MLCC is a kind of special design 、 special technology MLCC that bases on the technology of general MLCC. This kind of MLCC has stable high voltage reliability and suitable to SMT. Middle & high MLCC is widely applicable for many direct high voltage circuits in which it can improve the performance of the circuit.

APPLICATIONS

- Analog & Digital Modems
- LAN/WAN Interface
- Lighting Ballast Circuits
- Voltage Multipliers
- DC-DC Converters
- Back-lighting Inverters

容量范围及其电压

单位/unit: pF

尺寸规格 Size Code	工作电压 Rated Voltage	容量范围 Capacitance		
		NPO	X7R	Y5V
0603	100V	0.5 ~ 1,000	150 ~ 100,000	2,200 ~ 100,000
	200V	0.5 ~ 470	150 ~ 10,000	——
	250V	0.5 ~ 470	150 ~ 10,000	——
0805	100V	0.5 ~ 3,300	150 ~ 100,000	10,000 ~ 100,000
	200V	0.1 ~ 1,500	150 ~ 22,000	10,000 ~ 47,000
	250V	0.1 ~ 1,500	150 ~ 22,000	10,000 ~ 47,000
	500V	0.1 ~ 470	150 ~ 10,000	——
	630V	0.1 ~ 470	150 ~ 10,000	——
	1000V	0.1 ~ 100	——	——
1206	100V	0.5 ~ 3,300	150 ~ 1,000,000	15,000 ~ 470,000
	200V	0.1 ~ 2,700	150 ~ 220,000	10,000 ~ 220,000
	250V	0.1 ~ 2,700	150 ~ 220,000	10,000 ~ 220,000
	500V	0.1 ~ 1,500	150 ~ 33,000	——
	630V	0.1 ~ 1,500	150 ~ 33,000	——
	1000V	0.1 ~ 1,000	150 ~ 10,000	——
	2000V	0.1 ~ 270	150 ~ 2,700	——



容量范围及其电压

单位/unit: pF

尺寸规格 Size Code	工作电压 Rated Voltage	容量范围 Capacitance		
		NPO	X7R	Y5V
1210	100V	1.0 ~ 6,800	150 ~ 2,200,000	15,000 ~ 1,000,000
	200V	1.0 ~ 3,300	150 ~ 220,000	15,000 ~ 470,000
	250V	1.0 ~ 3,300	150 ~ 220,000	15,000 ~ 470,000
	500V	1.0 ~ 2,200	150 ~ 68,000	——
	630V	1.0 ~ 2,200	150 ~ 68,000	——
	1000V	1.0 ~ 1,000	150 ~ 22,000	——
	2000V	1.0 ~ 470	150 ~ 10,000	——
	3000V	——	150 ~ 680	——
	4000V	——	150 ~ 680	——
1808	100V	2.0 ~ 4,700	220 ~ 2,200,000	150,000 ~ 1,000,000
	200V	2.0 ~ 3,900	220 ~ 220,000	10,000 ~ 390,000
	250V	2.0 ~ 3,900	220 ~ 220,000	10,000 ~ 390,000
	500V	2.0 ~ 2,700	220 ~ 68,000	——
	630V	2.0 ~ 2,700	220 ~ 68,000	——
	1000V	2.0 ~ 1,000	150 ~ 22,000	——
	2000V	2.0 ~ 470	150 ~ 10,000	——
	3000V	2.0 ~ 330	150 ~ 4,700	——
	4000V	2.0 ~ 33	150 ~ 2,200	——
1812	100V	3.0 ~ 10,000	270 ~ 1,000,000	150,000 ~ 2,200,000
	200V	3.0 ~ 6,800	270 ~ 560,000	100,000 ~ 470,000
	250V	3.0 ~ 6,800	270 ~ 560,000	100,000 ~ 470,000
	500V	3.0 ~ 4,700	270 ~ 150,000	——
	630V	3.0 ~ 4,700	270 ~ 150,000	——
	1000V	3.0 ~ 1,200	270 ~ 56,000	——
	2000V	3.0 ~ 1,000	270 ~ 12,000	——
	3000V	3.0 ~ 560	270 ~ 4,700	——
	4000V	3.0 ~ 220	270 ~ 3,300	——
1825	100V	3.0 ~ 22,000	12,000 ~ 1,200,000	150,000 ~ 2,200,000
	200V	3.0 ~ 8,200	12,000 ~ 1,000,000	100,000 ~ 470,000
	250V	3.0 ~ 8,200	12,000 ~ 1,000,000	100,000 ~ 470,000
	500V	3.0 ~ 5,600	1,000 ~ 470,000	——
	630V	3.0 ~ 5,600	1,000 ~ 470,000	——
	1000V	3.0 ~ 1,800	1,000 ~ 100,000	——
	2000V	3.0 ~ 1,000	1,000 ~ 22,000	——
	3000V	3.0 ~ 680	1,000 ~ 10,000	——
	4000V	3.0 ~ 470	1,000 ~ 6,800	——
5000V	3.0 ~ 82	——	——	



尺寸规格 Size Code	工作电压 Rated Voltage	容量范围 Capacitance		
		NPO	X7R	Y5V
2220	100V	5.0 ~ 27,000	22,000 ~ 1,200,000	150,000 ~ 1,500,000
	200V	5.0 ~ 12,000	22,000 ~ 1,000,000	100,000 ~ 1,000,000
	250V	5.0 ~ 12,000	22,000 ~ 1,000,000	100,000 ~ 1,000,000
	500V	5.0 ~ 6,800	1,500 ~ 470,000	——
	630V	5.0 ~ 6,800	1,500 ~ 470,000	——
	1000V	5.0 ~ 3,900	1,500 ~ 100,000	——
	2000V	5.0 ~ 1,000	1,500 ~ 33,000	——
	3000V	5.0 ~ 680	1,500 ~ 10,000	——
	4000V	5.0 ~ 560	1,500 ~ 6,800	——
	5000V	5.0 ~ 120	——	——
2225	100V	5.0 ~ 27,000	2,200 ~ 2,200,000	250,000 ~ 3,300,000
	200V	5.0 ~ 12,000	2,200 ~ 2,200,000	220,000 ~ 2,200,000
	250V	5.0 ~ 12,000	2,200 ~ 2,200,000	220,000 ~ 2,200,000
	500V	5.0 ~ 6,800	2,200 ~ 470,000	——
	630V	5.0 ~ 6,800	2,200 ~ 470,000	——
	1000V	5.0 ~ 3,900	2,200 ~ 100,000	——
	2000V	5.0 ~ 1,000	2,200 ~ 47,000	——
	3000V	5.0 ~ 680	2,200 ~ 15,000	——
	4000V	5.0 ~ 560	2,200 ~ 6,800	——
	5000V	5.0 ~ 120	——	——
3012	100V	5.0 ~ 27,000	150 ~ 3,300,000	15,000 ~ 1,500,000
	200V	5.0 ~ 12,000	150 ~ 2,200,000	15,000 ~ 1,000,000
	250V	5.0 ~ 12,000	150 ~ 1,200,000	——
	500V	5.0 ~ 6,800	150 ~ 220,000	——
	630V	5.0 ~ 6,800	150 ~ 150,000	——
	1000V	5.0 ~ 3,900	150 ~ 47,000	——
	2000V	5.0 ~ 1,000	150 ~ 33,000	——
	3000V	5.0 ~ 1,000	150~10,000	——
	4000V	5.0 ~ 1,000	150~8,200	——
	5000V	5.0 ~ 120	——	——
3035	100V	5.0 ~ 27,000	47,000 ~ 4,700,000	10,000 ~ 2,200,000
	200V	5.0 ~ 12,000	47,000 ~ 2,200,000	10,000 ~ 2,200,000
	250V	5.0 ~ 12,000	47,000 ~ 2,200,000	10,000 ~ 2,200,000
	500V	5.0 ~ 6,800	5,600 ~ 1,000,000	——
	630V	5.0 ~ 6,800	5,600 ~ 470,000	——
	1000V	5.0 ~ 3,900	5,600 ~ 56,000	——
	2000V	5.0 ~ 1,000	5,600 ~ 47,000	——
	5000V	5.0 ~ 120	——	——

备注：可根据客户的特殊要求设计符合客户需求的产品。

Note：We can design according to customer special requirements.



中高压电容器介质耐电强度的测试方法：

Measurement method of dielectric withstanding voltage for high voltage MLCC

额定电压范围 Rated voltage range	耐电性能的测试方法 Measuring Method
100V Vr < 500V	施加额定电压的 200%，5 秒，最大电流不超过 50mA Force 200% Rated voltage for 5 second. Max..current should not exceed 50 mA.
500V Vr 1000V	施加额定电压的 150%，5 秒，最大电流不超过 50mA Force 150% Rated voltage for 5 second. Max..current should not exceed 50 mA.
1000V < Vr 2000V	施加额定电压的 120%，5 秒，最大电流不超过 50mA Force 120% Rated voltage for 5 seconds. Max..current should not exceed 50 mA.
2000V < Vr 5000V	施加额定电压的 120%，5 秒，最大电流不超过 10mA Force 120% Rated voltage for 5 seconds. Max..current should not exceed 10 mA.

八、可靠性测试 Reliability Test

项目 Item	技术规格 Technical Specification		测试方法 Test Method and Remarks		
容量 Capacitance	类 Class	应符合指定的误差级别 Should be within the specified tolerance.	标称容量 Capacitance	测试频率 Measuring Frequency	测试电压 Measuring Voltage
	类 Class	应符合指定的误差级别 Should be within the specified tolerance.	1000pF > 1000 pF	1MHZ ± 10% 1KHZ ± 10%	1.0 ± 0.2Vrms
			测试温度：25 ± 3 Test Temperature: 25 ± 3 C 10μF：测试频率：1KHZ ± 10% 测试电压：1.0 ± 0.2Vrms Test Frequency: 1KHZ ± 10% Test Voltage: 1.0 ± 0.2Vrms C > 10μF X7R、X5R、X7S、X6S、Y5V： 测试频率：120 ± 24 HZ 测试电压：0.5 ± 0.1Vrms Test Frequency: 120 ± 24 HZ Test Voltage: 0.5 ± 0.1Vrms Z5U：测试频率：1 ± 0.1KHZ 测试电压：0.5 ± 0.05Vrms Test Frequency: 1 ± 0.1KHZ Test Voltage: 0.5 ± 0.05Vrms		
损耗角正切 (DF, tan) Dissipation Factor	类 Class	DF	标称容量 Capacitance	测试频率 Measuring Frequency	测试电压 Measuring Voltage
		0.56%	Cr < 5 pF	1MHZ ± 10%	1.0 ± 0.2Vrms
		$1.5[(150/Cr)+7] \times 10^{-4}$	5pF Cr < 50 pF	1MHZ ± 10%	
		0.15%	50pF Cr 1000 pF	1MHZ ± 10%	
0.15%	> 1000 pF	1KHZ ± 10%			



项目 Item	技术规格 Technical Specification							测试方法 Test Method and Remarks		
损耗角正切(DF, tan) Dissipation Factor	类 Class	X7R/ X5R	50V	25V	16V	10V	6.3V	C < 10μF 测试频率: 1KHZ ± 10% 测试电压: 1.0 ± 0.2Vrms Test Frequency: 1KHZ ± 10% Test Voltage: 1.0 ± 0.2Vrms C > 10μF X7R、X5R、X7S、X6S、Y5V 测试频率: 120 ± 24 HZ 测试电压: 0.5 ± 0.1Vrms Test Frequency: 120 ± 24HZ Test Voltage: 0.5 ± 0.1Vrms Z5U:测试频率: 1 ± 0.1KHZ 测试电压: 0.5 ± 0.05Vrms Test Frequency: 1 ± 0.1KHZ Test Voltage: 0.5 ± 0.05Vrms		
		X7S/ X6S (0402)	2.5%	3.5% (C < 0.47μF) 100% (C < 0.47μF)	3.5% (C < 0.47μF) 100% (C < 0.47μF)	5.0% (C < 0.15μF) 100% (C < 0.15μF)	5.0% (C < 0.15μF) 100% (C < 0.15μF)			
	X7R/ X5R	50V	25V	16V	10V	6.3V				
	X7S/ X6S (< 0402)	3.5%	5.0%	5.0% (C < 0.047μF) 10% (C > 0.047μF)	7.5% (C < 0.047μF) 10% (C > 0.047μF)	7.5% (C < 0.047μF) 10% (C > 0.047μF)				
		Y5V Z5U		25V 7.0% (C < 1.0μF) 9.0% (C < 1.0μF)	16V 15%	10V 15%	6.3V 15%			
绝缘电阻 (IR) Insulation Resistance	类 Class	C < 10 nF, Ri 50000M C > 10 nF, Ri C _R 500S							测试电压: 额定电压 (最高 500V) 测试时间: 60 ± 5 秒 测试湿度: 75% 测试温度: 25 ± 3 测试充放电电流: 50mA Measuring Voltage: Rated Voltage (Max 500V) Duration: 60 ± 5s Test Humidity: 75% Test Temperature: 25 ± 5 Test Current: 50mA	
	类 Class	X7R/ X5R/ X7S/ X6S	C < 25 nF, Ri 10000M C > 25 nF, Ri C _R > 100S							
	类 Class	Y5V Z5U	C < 25 nF, Ri 4000M C > 25 nF, Ri C _R > 100S							
介质耐电强度(DWV) Dielectric Withstanding Voltage	不应有介质被击穿或损伤 No breakdown or damage.							测量电压: 类:300%额定电压 类:250%额定电压 时间: 1 ~ 5 秒 充/放电电流: 不应超过 50mA (这部分说明不包括中高压 MLCC) Measuring Voltage: Class :300% Rated voltage Class :250% Rated voltage Duration: 1 ~ 5s Charge/ Discharge Current: 50mA max. (This method excludes high-voltage MLCC)		

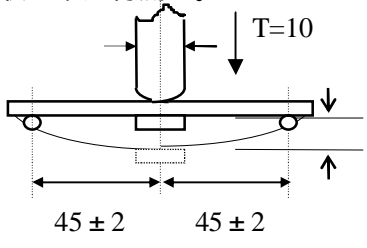

项目 Item	技术规格 Technical Specification				测试方法 Test Method and Remarks
可焊性 Solderability	上锡率应大于 95% 外观：无可见损伤。 At least 95% of the terminal electrode is covered by new solder. Visual Appearance: No visible damage.				将电容在 80~120 的温度下预热 10~30 秒。 Preheating conditions: 80 to 120 ; 10~30s.
	有铅焊料: (Sn/Pb : 63/37) 浸锡温度: 235 ± 5 浸锡时间: 2 ± 0.5s Solder Temperature: 235 ± 5 Duration: 2 ± 0.5s		无铅焊料: 浸锡温度: 245 ± 5 浸锡时间: 2 ± 0.5s Solder Temperature: 245 ± 5 Duration: 2 ± 0.5s		
耐焊热 Resistance to Soldering Heat	项目 Item	NPO 至 SL NPO to SL	X7R/X5R/ X7S/X6S	Y5V、 Z5U	将电容在 100~200 的温度下预热 10 ± 2 分钟。 浸锡温度: 265 ± 5
	CC	± 0.5% 或 ± 0.5PF, 取较大值 ± 0.5% or ± 0.5PF whichever is larger	-5~+10%	-10~+2 0%	浸锡时间: 10 ± 1s 然后取出溶剂清洗干净, 在 10 倍以上的显微镜底下观察。 放置时间: 24 ± 2 小时 放置条件: 室温
	DF	同初始标准 Same to initial value.			Preheating conditions: 100 to 200 ; 10 ± 2min. Solder Temperature: 265 ± 5
	IR	同初始标准 Same to initial value.			Duration: 10 ± 1s
	外观: 无可见损伤 上锡率: 95% Appearance: No visible damage. At least 95% of the terminal electrode is covered by new solder.				Clean the capacitor with solvent and examine it with a 10X(min.) microscope. Recovery Time: 24 ± 2h Recovery condition: Room temperature
抗弯曲强度 Resistance to Flexure of Substrate (Bending Strength)	外观: 无可见损伤。 Appearance: No visible damage.				试验基板: Al ₂ O ₃ 或 PCB 弯曲深度: 1mm 施压速度: 0.5mm/sec. 单位: mm 应在弯曲状态下进行测量。
	C/C	± 10%			 Test Board: Al ₂ O ₃ or PCB Warp: 1mm Speed: 0.5mm/sec. Unit: mm The measurement should be made with the board in the bending position.



项目 Item	技术规格 Technical Specification	测试方法 Test Method and Remarks																														
端头结合强度 Termination Adhesion	外观无可见损伤 No visible damage.	施加的力：5N 时间：10 ± 1S Applied Force: 5N Duration: 10 ± 1S																														
温度循环 Temperature Cycle	<p>C/C: 类： ± 1% 或 ± 1pF , 取两者中最大者 类： B,X,BS,DS: ± 10% E,F: ± 20%</p> <p>Class : ± 1% or ± 1pF, whichever is larger. Class : B,X,BS,DS: ± 10% E,F: ± 20%</p>	<p>预处理 (2类): 上限类别温度, 1小时 恢复：24 ± 1h 初始测量 循环次数：5次，一个循环分以下4步：</p> <table border="1"> <thead> <tr> <th>阶段</th> <th>温度 ()</th> <th>时间(分钟)</th> </tr> </thead> <tbody> <tr> <td>第1步</td> <td>下限温度^(NPO/X7R/X7S/X6S/X5R:-55 Y5V:-25 Z5U:+10)</td> <td>30</td> </tr> <tr> <td>第2步</td> <td>常温 (+20)</td> <td>2 ~ 3</td> </tr> <tr> <td>第3步</td> <td>上限温度^(NPO/X7R/X7S: Y5V/Z5U/X5R:+85 X6S:+105)</td> <td>30</td> </tr> <tr> <td>第4步</td> <td>常温 (+20)</td> <td>2 ~ 3</td> </tr> </tbody> </table> <p>试验后放置 (恢复) 时间：24 ± 2h Preheating conditions: up-category temperature, 1h Recovery time: 24 ± 1h Initial Measurement Cycling Times: 5 times, 1 cycle, 4 steps:</p> <table border="1"> <thead> <tr> <th>Step</th> <th>Temperature ()</th> <th>Time (min.)</th> </tr> </thead> <tbody> <tr> <td>1</td> <td>Low-category temp. ^(NPO/X7R/X7S/X6S/X5R:-55 Y5V:-25 Z5U:+10)</td> <td>30</td> </tr> <tr> <td>2</td> <td>Normal temp. (+20)</td> <td>2 ~ 3</td> </tr> <tr> <td>3</td> <td>Up-category temp. ^(NPO/X7R/X7S: Y5V/Z5U/X5R:+85 X6S:+105)</td> <td>30</td> </tr> <tr> <td>4</td> <td>Normal temp. (+20)</td> <td>2 ~ 3</td> </tr> </tbody> </table> <p>Recovery time after test: 24 ± 2h</p>	阶段	温度 ()	时间(分钟)	第1步	下限温度 ^(NPO/X7R/X7S/X6S/X5R:-55 Y5V:-25 Z5U:+10)	30	第2步	常温 (+20)	2 ~ 3	第3步	上限温度 ^(NPO/X7R/X7S: Y5V/Z5U/X5R:+85 X6S:+105)	30	第4步	常温 (+20)	2 ~ 3	Step	Temperature ()	Time (min.)	1	Low-category temp. ^(NPO/X7R/X7S/X6S/X5R:-55 Y5V:-25 Z5U:+10)	30	2	Normal temp. (+20)	2 ~ 3	3	Up-category temp. ^(NPO/X7R/X7S: Y5V/Z5U/X5R:+85 X6S:+105)	30	4	Normal temp. (+20)	2 ~ 3
阶段	温度 ()	时间(分钟)																														
第1步	下限温度 ^(NPO/X7R/X7S/X6S/X5R:-55 Y5V:-25 Z5U:+10)	30																														
第2步	常温 (+20)	2 ~ 3																														
第3步	上限温度 ^(NPO/X7R/X7S: Y5V/Z5U/X5R:+85 X6S:+105)	30																														
第4步	常温 (+20)	2 ~ 3																														
Step	Temperature ()	Time (min.)																														
1	Low-category temp. ^(NPO/X7R/X7S/X6S/X5R:-55 Y5V:-25 Z5U:+10)	30																														
2	Normal temp. (+20)	2 ~ 3																														
3	Up-category temp. ^(NPO/X7R/X7S: Y5V/Z5U/X5R:+85 X6S:+105)	30																														
4	Normal temp. (+20)	2 ~ 3																														
潮湿试验 Moisture Resistance	C/C	<p>类： ± 2% 或 ± 1pF, 取两者之中较大者 类: B,X,BS,DS: ± 10% E,F: ± 30%</p> <p>Class : ± 2% or ± 1pF, whichever is larger. Class : B,X,BS,DS: ± 10% E,F: ± 30%</p>	<p>温度：40 ± 2 湿度：90~95%RH 时间：500小时 放置条件：室温 放置时间：24小时(类)；48小时(类) Temperature：40 ± 2 Humidity：90~95%RH Duration：500h Recovery conditions：Room temperature Recovery Time：24h (Class1) or 48h (Class2)</p>																													
	DF	2倍初始标准 Not more than twice of initial value.																														
	IR	类：Ri 2500M 或 Ri C _R 25S 取两者之中较小者。 Class：Ri 2500M 或 Ri C _R 25S whichever is smaller.																														
		类：Ri 1000M 或 Ri C _R 25S 取两者之中较小者。 Class：Ri 1000M 或 Ri C _R 25S whichever is smaller.																														
外观：无损伤 Appearance: No visible damage.																																



项目 Item	技术规格 Technical Specification		测试方法 Test Method and Remarks
寿命试验 Life Test	C/C	类：±2%或±1pF 取两者之中较大者 类：B,X,BS,DS: ±20% E,F: ±30% Class : ±2% or ±1pF, whichever is larger. Class : B,X,BS,DS: ±20% E,F: ±30%	低压产品 (100V) 电压：1.5 倍额定工作电压 时间：1000 小时 温度：125 (NPO、X7R、X7S) 85 (X5R、Y5V) 105 (X6S) 充电电流：不应超过 50mA 放置条件：室温 放置时间：24 小时 (类), 或 48 小时 (类), Low-Voltage (100V) Applied Voltage: 1.5 × Rated Voltage Duration: 1000h Temperature : 125 (NPO、X7R、X7S) 85 (X5R、Y5V) 105 (X6S) Charge/ Discharge Current: 50mA max. Recovery Conditions: Room Temperature Recovery Time: 24h (Class 1), or 48h (Class2)
	DF	2 倍初始标准 Not more than twice of initial value.	
	IR	类：Ri 4000M 或 Ri C _R 40S 取两者之中较小者。 Class : Ri 4000M 或 Ri C _R 40S whichever is smaller.	
		类：Ri 2000M 或 Ri C _R 50S 取两者之中较小者。 Class : Ri 2000M 或 Ri C _R 50S whichever is smaller.	
外观：无损伤 Visual Appearance: No visible damage.			
中高压产品 寿命试验 Middle & high voltage Life Test	C/C	类：±2%或±1pF 取两者之中较大者 类：B,X,BS,DS: ±20% E,F: ±30% Class : ±2% or ±1pF, whichever is larger. Class : B,X,BS,DS: ±20% E,F: ±30%	中高压产品： 100V 额定电压 < 500V：2 倍工作电压 500V 额定电压 1000V：1.5 倍工作电压 额定电压 > 1000V：1.2 倍工作电压 时间：1000 小时 充电电流：不应超过 50mA 温度：125 (NPO X7R、X7S); 85 (X5R、Y5V) 105 (X6S) 放置条件：室温 放置时间：24 小时 (类), 或 48 小时 (类), Applied Voltage: 100V Rated Voltage < 500V：2 Multiple 500V Rated Voltage 1000V：1.5 Multiple > 1000V Rated Voltage：1.2 Multiple Duration: 1000h Charge/ Discharge Current: 50mA max. Temperature : 125 (NPO X7R、X7S); 85 (X5R、Y5V) 105 (X6S) Recovery Conditions: Room Temperature Recovery Time: 24h (Class 1), or 48h (Class2)
	DF	2 倍初始标准 Not more than twice of initial value.	
	IR	类：Ri 4000M 或 Ri C _R 40S 取两者之中较小者。 Class : Ri 4000M 或 Ri C _R 40S whichever is smaller.	
		类：Ri 2000M 或 Ri C _R 50S 取两者之中较小者。 Class : Ri 2000M 或 Ri C _R 50S whichever is smaller.	
外观：无损伤 Visual Appearance: No visible damage.			

注解：

专门预处理（仅对 2 类电容器）：

将电容器放在上限类别温度或按详细规范中可能规定的更高温度下经 1h 后，接着在试验的标准大气条件下恢复 24 ± 1h。

Note : Pretreatment (only for class2 capacitor)

Pretreatment (only for class2 capacitor) is a method to treat the capacitor before measurement. First, place the capacitor in the up-category temperature or other specified higher temperature environment for 1hour. Then recovery the capacitor at standard pressure conditions for 24 ± 1hours.

九、包装 PACKAGE

纸带卷盘结构 PAPER TAPING

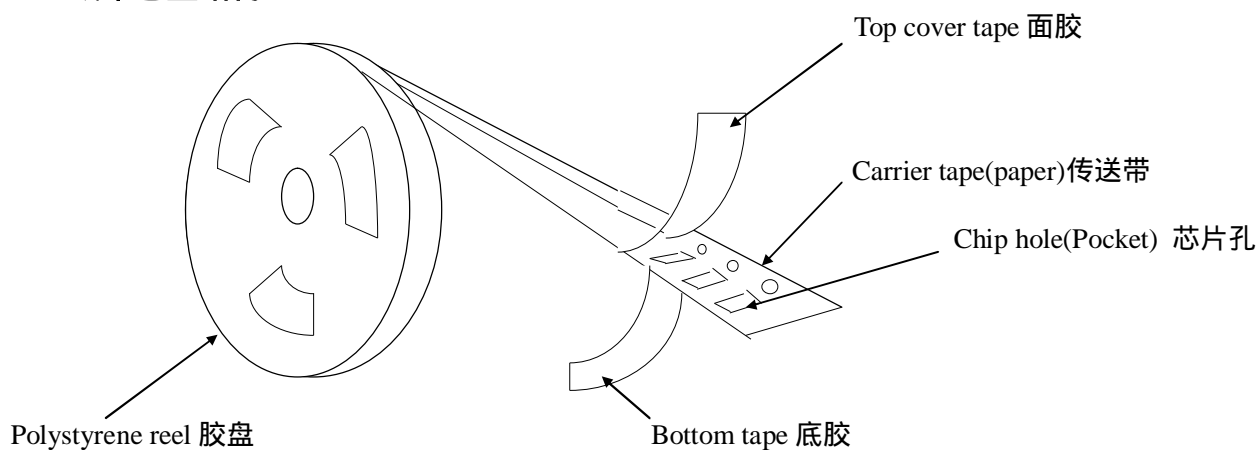

0201、0402 纸带编带尺寸大小

Dimensions of paper taping for 0402 type

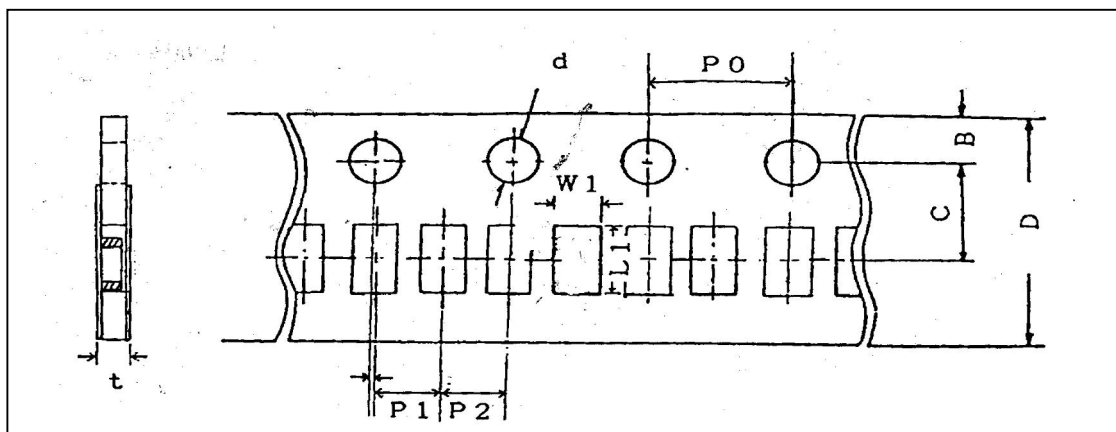

代号 Code	W1	L1	D	C	B	P1	P2	P0	d	t
0201	0.37± 0.10	0.67± 0.10	8.00± 0.10	3.50± 0.05	1.75± 0.10	2.00± 0.05	2.00± 0.05	4.00± 0.10	1.50 -0/+0.10	0.80 Below
0402	0.65± 0.10	1.15± 0.10	8.00± 0.10	3.50± 0.05	1.75± 0.10	2.00± 0.05	2.00± 0.05	4.00± 0.10	1.50 -0/+0.10	0.80 Below

适合 '0603, 0805, 1206' 常规尺寸产品的纸带尺寸

Dimensions of paper taping for 0603, 0805, 1206 types.



Unit : mm

代号 Code 纸带规格 paper size	A	B	C	D*	E	F	G*	H	J	T
0603	1.10 ±0.10	1.90 ±0.10	8.00 ±0.10	3.50 ±0.05	1.75 ±0.10	4.00 ±0.10	2.00 ±0.10	4.00 ±0.10	1.50 -0/+0.10	1.10 Max
0805	1.45 ±0.15	2.30 ±0.15	8.00 ±0.15	3.50 ±0.05	1.75 ±0.10	4.00 ±0.10	2.00 ±0.10	4.00 ±0.10	1.50 -0/+0.10	1.10 Max
1206	1.80 ±0.20	3.40 ±0.20	8.00 ±0.20	3.50 ±0.05	1.75 ±0.10	4.00 ±0.10	2.00 ±0.10	4.00 ±0.10	1.50 -0/+0.10	1.10 Max

注意：*表示此处对尺寸的要求非常精确。

Note: The place with "*" means where needs exactly dimensions.

塑胶卷盘结构 EMBOSED TAPING



塑胶带尺寸结构(适合 ' 0805~1812 ' 型产品)

Dimensions of embossed taping for 0805~1812 type

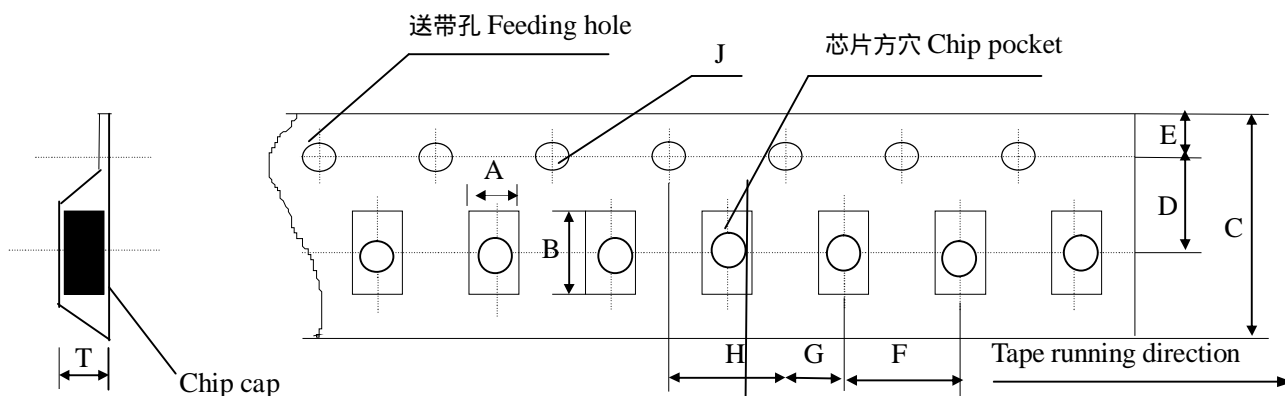

塑胶带传送方向

代号 Code	A	B	C	D*	E	F	G*	H	J	T
规格 Tape size										
0805	1.55 ±0.20	2.35 ±0.20	8.00 ±0.20	3.50 ±0.05	1.75 ±0.10	4.00 ±0.10	2.00 ±0.10	4.00 ±0.10	1.50 -0/+0.10	1.50 Max
1206	1.95 ±0.20	3.60 ±0.20	8.00 ±0.20	3.50 ±0.05	1.75 ±0.10	4.00 ±0.10	2.00 ±0.10	4.00 ±0.1	1.50 -0/+0.10	1.85 Max
1210	2.70 ±0.10	3.42 ±0.10	8.00 ±0.10	3.50 ±0.05	1.75 ±0.10	4.00 ±0.10	2.00 ±0.05	4.00 ±0.10	1.55 -0/+0.10	3.2 Max
1808	2.20 ±0.10	4.95 ±0.10	12.00 ±0.10	5.50 ±0.05	1.75 ±0.10	4.00 ±0.10	2.00 ±0.05	4.00 ±0.10	1.50 -0/+0.10	3.0 Max
1812	3.66 ±0.10	4.95 ±0.10	12.00 ±0.10	5.50 ±0.05	1.75 ±0.10	8.00 ±0.10	2.00 ±0.05	4.00 ±0.10	1.55 -0/+0.10	4.0 Max

备注：*表示此处对尺寸的要求非常精确。

Note: The place with "*" means where needs exactly dimensions.

传送带的前后结构 Structure of leader part and end part of the carrier paper



卷盘尺寸 Reel Dimensions (unit: mm)



尺寸代码 (CODE)

卷盘型号	A	B	C	D	E	F	G
7 REEL	178±20	3.0	13±0.5	21±0.8	50 或更大 50 or more	100±1.5	12max
13 REEL	330±20	3.0	13±0.5	21±0.8	50 或更大 50 or more	100±1.5	12max

关于卷带的说明 Taping specification

面胶剥离强度 Top tape peeling strength

(a) 纸带 Paper Taping



(b) 塑料胶盘 Embossed Taping



标准：0.1N<剥离强度<0.7N

Standard: 0.1N < peeling strength < 0.7N

在剥离时，纸带不能有纸碎，也不能粘在底、面胶上。

No paper dirty remains on the scotch when peeling, and sticks to top and bottom tape.



塑料盒散包装 Bulk Case Package

单位 (unit) :mm

Symbol	A	B	T	C	D	E
Dimension	6.80 ± 0.10	8.80 ± 1.00	12.00 ± 0.10	15.00+0.10/-0	2.00+0/-0.10	4.70 ± 0.10
Symbol	F	W	G	H	L	I
Dimension	31.50+0.20/-0	36.00+0/-0.20	19.00 ± 0.35	7.00 ± 0.35	110.00 ± 0.70	5.00 ± 0.35

包装数量 Packing Quantity

尺寸 (SIZE)	包装形式和数量 (PACKAGE STYLE & QUANTITY) unit: pcs			
	纸带卷盘 (PT)	胶带卷盘 (ET)	塑料盒散装 (BC)	一般散装 (BP)
0201	15000	-----	20000	5000
0402	10000	-----	20000	5000
0603	4000	-----	15000	5000
0805	4000	3000	10000	5000
1206	4000	T 1.35mm 3000 T > 1.35mm 2000	5000	5000
1210	-----	T 1.80mm 2000 T > 1.80mm 1000	-----	2000
1410	-----	2000	-----	-----
1808	-----	2000	-----	2000
1812	-----	T 1.85mm 1000 T > 1.85mm 500	-----	2000
1825、2220、 2025、2225、 3035	-----	500	-----	500

注意：包装的形式和数量可根据客户的要求来定。

Note : We can choose packing style and quantity can be according to the customer's requirement.



外包装 Outer packing

小包装 The first package

Quantity: 10 reels

数量：10卷

大包装 The second package

Quantity: 6 cases

数量：6盒



十、储存方法 Storage Methods

确保芯片可焊性良好的贮存期限为 6 个月(在包装好已交付的情况下)。

The guaranteed period for solderability is 6 months (Under deliver package condition).

储存条件/Storage conditions :

储存温度/Temperature 5~40

储存相对湿度/Relative Humidity 20~70%

十一、使用前的注意事项 Precautions For Use

多层片式瓷介电容器(MLCC)在短路或开路的电路中都有可能失效,在超出本承认书或相关说明书中所述使用频率的恶劣工作环境,或外界机械力超压作用下,电容芯片都有可能着火、燃烧甚至爆炸,所以在使用的时候,首先应考虑按本承认书的有关说明来进行,如有不明之处,请联系我们技术部、品管部或生产部。

The Multi-layer Ceramic Capacitors (MLCC) may fail in a short circuit modern in an open circuit mode when subjected to severe conditions of electrical environment and / or mechanical stress beyond the specified “rating” and specified “conditions” in the specification, which will result in burn out, flaming or glowing in the worst case. Following “precautions for “safety” and Application Notes shall be taken in your major consideration. If you have a question about the precautions for handling, please contact our engineering section or factory.

1. 焊接的条件与相关图表 Soldering Profile

为避免因温度的突然变化而引起的芯片开裂或局部爆炸的现象发生,请按有关温度曲线图表来进行。(请参考附页中的图表)

To avoid the crack problem by sudden temperature change, follow the temperature profile in the adjacent graph (refer to the graph in the enclosure page).



2. 手工焊接 Manual Soldering

手工焊接很容易因为芯片局部受热不均而引起瓷体微裂或局部爆炸的现象,在焊接时,如果操作者不小心,会使烙铁头直接同电容芯片的瓷体部分接触,这样很容易使电容芯片因热冲击而受损或出现其他意外.因此,使用电烙铁手工焊接时应仔细操作,并对电烙铁的尖端的选择和尖端温度控制应多加小心.

Manual soldering can pose a great risk of creating thermal cracks in capacitors. The hot soldering iron tip comes into direct contact with the end terminations, and operator's careless may cause the tip of the soldering iron to come into direct contact with the ceramic body of the capacitor. Therefore the soldering iron must be handled carefully, and pay much attention to the selection of the soldering iron tip and temperature contact of the tip.

3. 适量的焊料 Optimum Solder Amount for Reflow Soldering

焊料过多
Too much solder



这样会因端头压力过大而可能引起芯片受损
Cracks tend to occur due to large stress.

焊料太少
Not enough solder



固定力量不足,可能会引起电容芯片与线路接触不良
Weak holding force may cause bad connection between the capacitor and PCB.

4. 推荐焊料用量 Recommended Soldering amounts

4.1 回流焊接的最佳焊料用量

The optimal solder fillet amounts for re-flow soldering



4.2 波峰焊接的最佳焊料用量

The optimal solder fillet amounts for wave soldering



4.3 使用烙铁返修时的最佳焊料量

The optimal solder fillet amounts for reworking by using soldering iron

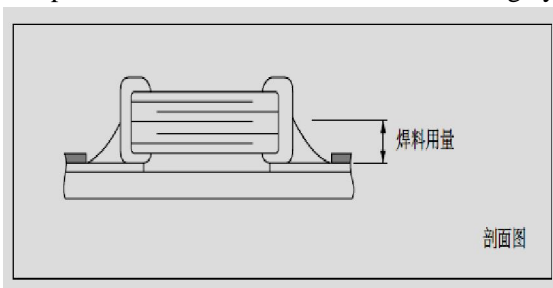



十二、推荐焊接方式 Recommended Soldering Method

规格尺寸 Size	温度特性 Temperature Characteristics	额定电压 Rated Voltage	容量范围 Capacitance	焊接方式 Soldering Method
0201	NPO	/		R
	X7R/X5R/X7S/X6S	/		R
	Y5V	/		R
0402	NPO	/		R
	X7R/X5R/X7S/X6S	/		R
	Y5V	/		R
0603	NPO	/		R/W
	X7R/X5R/X7S/X6S	/	C 1uf	R
			C < 1uf	R/W
	Y5V	/	C 1uf	R
C < 1uf			R/W	
0805	NPO	/	/	R/W
	X7R/X5R/X7S/X6S	/	C 4.7uf	R
			C < 4.7uf	R/W
	Y5V	/	C 1uf	R
C < 1uf			R/W	
1206	NPO	/	/	R/W
	X7R/X5R/X7S/X6S	/	C 10uf	R
			C < 10uf	R/W
	Y5V	/	C 10uf	R
C < 10uf			R/W	
1210	NPO	/	/	R
	X7R/X5R/X7S/X6S	/	/	R
	Y5V	/	/	R

焊接方式 Soldering method : R—回流焊 Reflow Solering

W—波峰焊 Wave Soldering



十三、推荐焊接温度曲线图 The temperature profile for soldering

回流焊接 (Re-flow soldering)

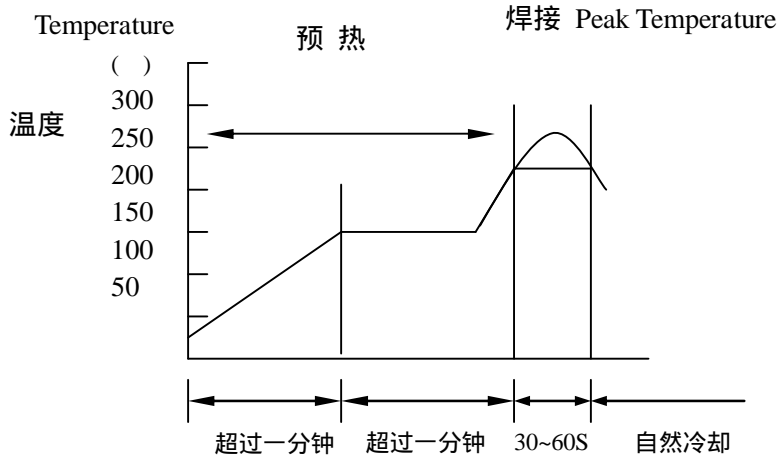

	Pb-Sn 焊接 Pb-Sn soldering	无铅焊接 Lead-free soldering
尖峰温度 Peak temperature	230 ~ 250	240 ~ 260

在预热时，请将焊接温度与芯片表面温度之间的温差维持在 T 150 。

While in preheating, please keep the temperature difference between soldering temperature and surface temperature of chips as: T 150 .

波峰焊接 (Wave soldering)



	Pb-Sn 焊接 Pb-Sn soldering	无铅焊接 Lead-free soldering
尖峰温度 Peak temperature	230 ~ 260	240 ~ 270

在预热时，请将焊接温度与芯片表面温度之间的温差维持在 T 150 。

While in preheating, please keep the temperature difference between soldering temperature and surface temperature of chips as: T 150 .



手工焊接 (Hand soldering)

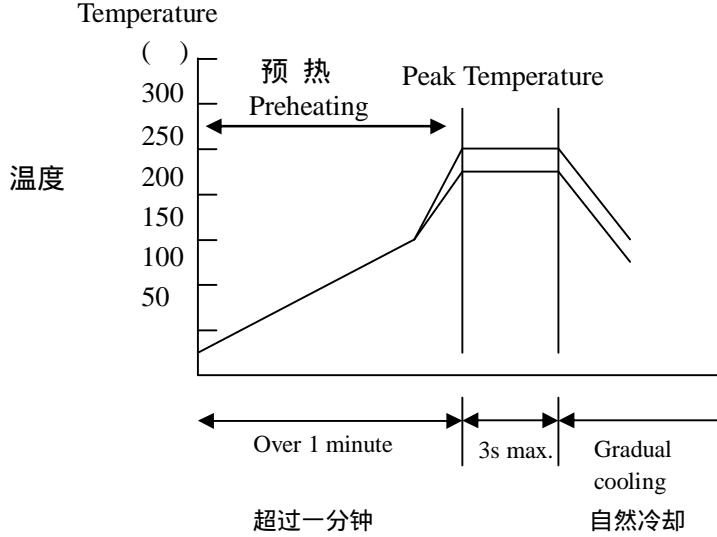

条件 Conditions :

预热 Preheating	烙铁头温度 Temperature of soldering iron head	烙铁功率 Power of soldering iron	烙铁头直径 Diameter of soldering iron head	焊接时间 Soldering time	锡膏量 Solder paste amount	限制条件 Restricted conditions
130	最高300 Highest temperature:300	最大20W 20W at the highest	建议1mm 1mm recommended	最长3s 3s at the longest	1/2 芯片厚度 1/2 chip thickness	请勿使用烙铁头直接接触陶瓷元件 Please avoid the direct contact between soldering iron head and ceramic components

以最新版本的内容为准

X-ON Electronics

Largest Supplier of Electrical and Electronic Components

Click to view similar products for [Multilayer Ceramic Capacitors MLCC - SMD/SMT](#) category:

Click to view products by [Fenghua Advanced](#) manufacturer:

Other Similar products are found below :

[M39014/02-1218V](#) [M39014/02-1225V](#) [M39014/22-0631](#) [D55342E07B523DR-T/R](#) [NIN-FC2R7JTRF](#) [NMC0402NPO220J50TRPF](#)
[NMC0402X5R105K6.3TRPF](#) [NMC0402X5R224K6.3TRPF](#) [NMC0402X7R103J25TRPF](#) [NMC0402X7R392K50TRPF](#)
[NMC0603NPO101F50TRPF](#) [NMC0603NPO201J50TRPF](#) [NMC0603NPO330G50TRPF](#) [NMC0603NPO331F50TRPF](#)
[NMC0603X5R475M6.3TRPF](#) [NMC0603X7R333K16TRPF](#) [NMC0805NPO220J100TRPF](#) [NMC0805NPO820J50TRPF](#)
[NMC0805X7R224K25TRPF](#) [NMC1206X7R102K50TRPF](#) [NMC1206X7R106K10TRPLPF](#) [NMC-H0805X7R472K250TRPF](#)
[C1608C0G2A221J](#) [C1608X7R1E334K](#) [C2012C0G2A472J](#) [2220J2K00562KXT](#) [CCR06CG153FSV](#) [CDR04BX104AKSR](#)
[CDR33BX104AKUR](#) [CDR33BX683AKUS](#) [CGA3E1X7R1C684K](#) [CL10C0R8BB8ANNC](#) [M55342H06B20G0R-T/R](#) [C1005X5R0G225M](#)
[C2012X7R2E223K](#) [C3216C0G2J272J](#) [D55342E07B35E7R-T/R](#) [CDR34BX563BKUS](#) [CDR34BX563BKWS](#) [NMC0402NPO220F50TRPF](#)
[NMC0402X7R562J25TRPF](#) [NMC0603NPO102J25TRPF](#) [NMC1206X7R332K50TRPF](#) [NMC-P1206X7R104K250TRPLPF](#) [726632-1](#)
[CGA6M3X7R1H225K](#) [CGA5L2X7R2A105K](#) [CGA3E2X8R1H223K](#) [CDR33BX823AKUR\M500](#) [CDR33BP132BJUR](#)