

## ■ 車規AB系列厚膜片式固定電阻器

### Thick Film Chip Fixed Resistor Automotive Grade (AB series)

#### ● 特點 Features

- \* 符合AEC-Q200汽車標準相關條款 Compliant with AEC-Q200 standard
- \* 體積小、重量輕 Miniature and light weight
- \* 適應再流焊與波峰焊 Suit for reflow and wave flow solder
- \* 電性能穩定，可靠性高 Stable electrical capability, high reliability
- \* 裝配成本低，并與自動貼裝設備匹配 Low assembly cost, suit for automatic SMT equipment
- \* 機械强度高、高頻特性優越 Superior mechanical and frequency characteristics
- \* 具有一定的抗硫化能力 With sulfuration-resistant performance
- \* 符合RoHS指令要求 Compliant with RoHS directive
- \* 符合無鹵素要求 Halogen free requirement



#### ● 應用領域 Application

車用儀表、車燈驅動模塊、車載信息系統、遙控鑰匙等。

Vehicle instrument, Lamp driving module, On-board information system, Remote control key, etc.

#### ● 品名構成 Type Designation

AB	D	03	K	1003	F	T					
<b>產品代號</b> Product Code	<b>額定功率代號</b> Rated Power Code		<b>電阻溫度系數代號</b> T.C.R Code			<b>電阻值誤差精度代號</b> Resistance Tolerance Code		<b>包裝方式代號</b> Packaging Style Code			
車規AB系列厚膜片式固定電阻器 Thick Film Chip Fixed Resistor Automotive Grade (AB series)	代號 Code	額定功率 Rated Power	代號 Code	型號 Type	代號 Code	T.C.R (ppm/°C)	代號 Code	誤差精度 Tolerance	代號 Code	包裝方法 Packaging Style	
	B	1/20W	01	0201	0201	W	±200	D	±0.5%	T	編帶包裝 Tape & Reel
	C	1/16W	02	0402		U	±400	F	±1%		
	D	1/10W	03	0603	0402 0603 0805 1206 1210 2010 2512	K	±100	G	±2%		
	E	1/8W	05	0805		L	±250	J	±5%		
	F	1/4W	06	1206		跨接電阻 Chip Jumper	無表示 No Marking	K	±10%	C	塑料袋散裝 Case
	R	1/3W	1210	1210	F			≤10mΩ			
	H	3/4W	10	2010	G			≤20mΩ			
	J	1W	12	2512	J	≤50mΩ					

結構 Construction

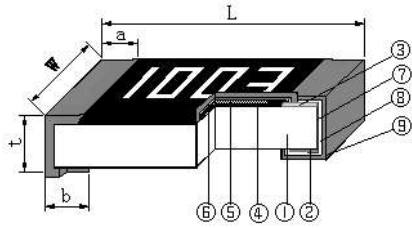

- ① 陶瓷基板 Ceramic Substrate
- ② 背電極 Bottom Electrode
- ③ 面電極 Top Electrode
- ④ 電阻體 Resistor Layer
- ⑤ 一次保護 Primary Overcoat
- ⑥ 二次保護 Secondary Overcoat
- ⑦ 端電極 Edge Electrode
- ⑧ 中間電極 Barrier Layer
- ⑨ 外部電極 External Electrode

規格尺寸 Dimensions

型號 Type	尺寸 Dimensions (mm)				
	L	W	t	a	b
0201	0.60±0.03	0.30±0.03	0.23±0.03	0.15±0.05	0.15±0.05
0402	1.00±0.05	0.50±0.05	0.35±0.05	0.25±0.15	0.25±0.10
0603	1.60±0.10	0.80±0.10	0.45±0.10	0.30±0.20	0.30±0.20
0805	2.00±0.10	1.25±0.15	0.55±0.10	0.30±0.20	0.40±0.20
1206	3.20±0.20	1.60±0.15	0.55±0.10	0.35±0.20	0.50±0.20
1210	3.20±0.20	2.50±0.20	0.55±0.10	0.35±0.20	0.50±0.20
2010	5.00±0.20	2.50±0.20	0.55±0.10	0.40±0.20	0.60±0.20
2512	6.30±0.20	3.20±0.20	0.55±0.10	0.40±0.20	0.60±0.20

負荷下降曲線 Derating Curve

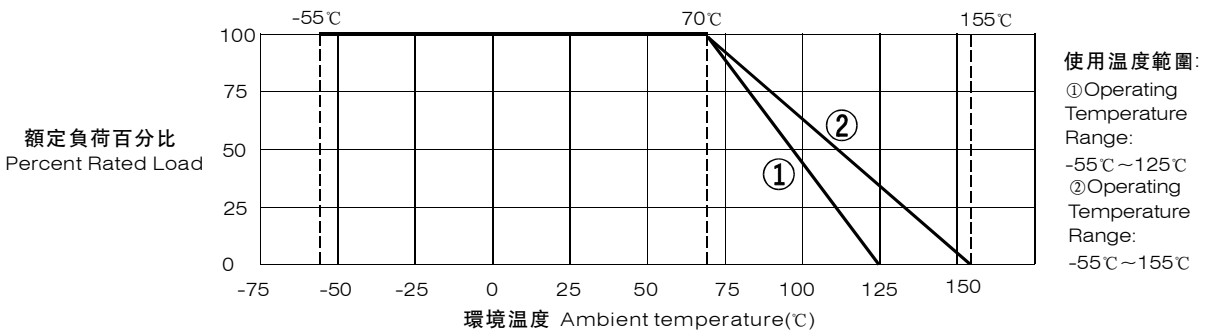

注1: 曲線①適用於0201產品; 曲線②適用於0402、0603、0805、1206、1210、2010、2512產品。

Note 1: 0201 product be the same with curve ①; 0402、0603、0805、1206、1210、2010、2512 be the same with curve ②.

注2: 當電阻使用的環境溫度超過70°C時, 其額定負荷(額定功率)按上述曲線下降。

Note 2: For resistors operated in ambient over 70°C, rated load (rated power) shall be derated in accordance with the above figure.

● 額定值 Ratings

型號 Type	70℃下額定功率 Rated Power at 70℃ (W)	元件極限電壓 Limiting Element Voltage (V)	最大過負荷電壓 Max. Overload Voltage (V)	跨接電阻70℃下 額定電流 Rated Current for Chip Jumper at 70℃ (A)	跨接電阻 最大過負荷電流 Max. Overload Current for Chip Jumper (A)
0201	1/20	25	50	0.5	1
0402	1/16	50	100	1	2
0603	1/10	75	150	1	3
0805	1/8	150	300	2	5
1206	1/4	200	400	2	5
1210	1/3	200	500	2	5
2010	3/4	200	500	2	5
2512	1	200	500	2	5
注 Note	1、電壓、電流為直流或交流有效值。 Voltage of DC or AC RMS value. 2、 $E = \sqrt{P \times R}$ 或元件極限電壓兩者中的較小值。 $E = \sqrt{P \times R}$ or Limiting element voltage whichever is lower. E: 額定電壓 Rated voltage(V) P: 額定功率 Rated power(W) R: 標稱阻值 Normal resistance( $\Omega$ )				

● 額定值 Ratings

型號 Type	阻值範圍 Resistance Range	電阻溫度系數 T.C.R (ppm/℃)				
		標稱阻值允許偏差 Resistance Tolerance				
		±0.5%	±1%	±2%	±5%	±10%
0201	$1\Omega \leq R < 10\Omega$	/	±400	±400	±400	±400
	$10\Omega \leq R < 1M\Omega$	±200	±200	±200	±200	±200
	$1M\Omega < R \leq 10M\Omega$	/	±400	±400	±400	±400
	0 $\Omega$ (跨接電阻 Jumper)	/				
0402 0603 0805 1206 1210 2020 2512	$1\Omega \leq R < 10\Omega$	/	±250	±250	±250	±250
	$10\Omega \leq R < 1M\Omega$	±100	±100	±100	±100	±100
	$1M\Omega < R \leq 10M\Omega$	/	±250	±250	±250	±250
	0 $\Omega$ (跨接電阻 Jumper)	/				

# 車規AB系列厚膜片式固定電阻器

THICK FILM CHIP FIXED RESISTOR AUTOMOTIVE GRADE (AB series)

## ● 特性 Characteristics

項目 Item	標準 Specifications		測試方法 Test Methods
	片式電阻器 Resistor	跨接電阻 Jumper	
高溫存儲 High Temperature Exposure (Storage)	無可見損傷 No mechanical damage 0.5%、1%: $\Delta R \leq \pm(1.0\%R+0.05\Omega)$ 2%、5%、10%: $\Delta R \leq \pm(2.0\%R+0.05\Omega)$	無可見損傷 No mechanical damage $R \leq 100\text{ m}\Omega$ (J級) $R \leq 40\text{ m}\Omega$ (G級) $R \leq 20\text{ m}\Omega$ (F級)	AEC-Q200 Test 3 /MIL-STD-202 Method 108 1000小時 @ T=155°C，不通電。 1000 hrs. @ T=155°C. Unpowered.
溫度循環 Temperature Cycling	無可見損傷 No mechanical damage 0.5%、1%: $\Delta R \leq \pm(0.5\%R+0.05\Omega)$ 2%、5%、10%: $\Delta R \leq \pm(1.0\%R+0.05\Omega)$	無可見損傷 No mechanical damage $R \leq 100\text{ m}\Omega$ (J級) $R \leq 40\text{ m}\Omega$ (G級) $R \leq 20\text{ m}\Omega$ (F級)	AEC-Q200 Test 4/JESD22 Method JA-104 -55°C(30分鐘) ~ 常溫( $\leq 1$ 分鐘) ~ 155°C(30分鐘)，1000個循環。 -55°C(30min) ~ normal temperature( $\leq 1$ min) ~ 155°C(30min),1000 cycles.
高溫高濕 Biased Humidity	無可見損傷 No mechanical damage $\Delta R \leq \pm(3.0\%R+0.05\Omega)$	無可見損傷 No mechanical damage $R \leq 100\text{ m}\Omega$ (J級) $R \leq 40\text{ m}\Omega$ (G級) $R \leq 20\text{ m}\Omega$ (F級)	AEC-Q200 Test 7/MIL-STD-202 Method 103 溫度85°C，濕度85%，10%額定功率(電流)，放置1000小時。 85°C/85%RH. Apply 10% of operating power(current) for 1000 hours,
工作壽命 Operational Life	無可見損傷 No mechanical damage 0.5%、1%: $\Delta R \leq \pm(1.0\%R+0.05\Omega)$ 2%、5%、10%: $\Delta R \leq \pm(3.0\%R+0.05\Omega)$	無可見損傷 No mechanical damage $R \leq 100\text{ m}\Omega$ (J級) $R \leq 40\text{ m}\Omega$ (G級) $R \leq 20\text{ m}\Omega$ (F級)	AEC-Q200 Test 8/ MIL-STD-202 Method 108 125°C ± 2°C，1000小時，額定電壓(電流)或元件極限電壓(取較小值)，通1.5小時/斷0.5小時。 125°C ± 2°C，1000h, rated voltage (current) or limiting element voltage whichever is lower for 1.5h ON/0.5h OFF.
耐溶劑性 Resistance to Solvents	標志清晰，無可見損傷 Clearly marked, No mechanical damage		AEC-Q200 Test 12/ MIL-STD-202 Method 215 浸在三種溶劑3min后擦拭10次，浸、刷共3回來，用水清洗劑進行清洗，並且室溫下對整個表面進行通風干燥。 Immersed in three solvents after 3min immersion, brush wipe 10 times, a total of 3 times, washing with washing and cleaning agent, room temperature on the surface of the ventilation drying.
機械衝擊 Mechanical Shock	無可見損傷 No mechanical damage $\Delta R \leq \pm(1.0\%R+0.05\Omega)$	無可見損傷 No mechanical damage $R \leq 50\text{ m}\Omega$ (J級) $R \leq 20\text{ m}\Omega$ (G級) $R \leq 10\text{ m}\Omega$ (F級)	AEC-Q200 Test 13/ MIL-STD-202 Method 213 正半弦波，峰值加速度：100g' s，脈衝持續時間：6ms，三軸六向各3次，共18次。 Positive half wave, peak acceleration: 100g' s, pulse duration: 6ms, three axis six to each 3 times, a total of 18 times.
振動 Vibration	無可見損傷 No mechanical damage $\Delta R \leq \pm(1.0\%R+0.05\Omega)$	無可見損傷 No mechanical damage $R \leq 50\text{ m}\Omega$ (J級) $R \leq 20\text{ m}\Omega$ (G級) $R \leq 10\text{ m}\Omega$ (F級)	AEC-Q200 Test 14/ MIL-STD-202 Method 204 頻率：10Hz~2000Hz,加速度：5g' s，一個循環20min，X、Y、Z三個方向每個方向12個循環，共36個循環。 Frequency: 10Hz ~ 2000Hz, acceleration: 5g' s, a loop 20min, X, Y, Z three directions, each direction 12 cycles, 36 cycles.
耐焊接熱 Resistance to Soldering Heat	無可見損傷 No mechanical damage 0.5%、1%: $\Delta R \leq \pm(0.5\%R+0.05\Omega)$ 2%、5%、10%: $\Delta R \leq \pm(1.0\%R+0.05\Omega)$	無可見損傷 No mechanical damage $R \leq 50\text{ m}\Omega$ (J級) $R \leq 20\text{ m}\Omega$ (G級) $R \leq 10\text{ m}\Omega$ (F級)	AEC-Q200 Test 15/ MIL-STD-202 Method 210 270°C ± 5°C 錫槽，保持10s ± 1s。 Lead-free solder bath at 270°C ± 5°C for 10s ± 1s.
熱衝擊 Thermal Shock	無可見損傷 No mechanical damage 0.5%、1%: $\Delta R \leq \pm(0.5\%R+0.05\Omega)$ 2%、5%、10%: $\Delta R \leq \pm(1.0\%R+0.05\Omega)$	無可見損傷 No mechanical damage $R \leq 50\text{ m}\Omega$ (J級) $R \leq 20\text{ m}\Omega$ (G級) $R \leq 10\text{ m}\Omega$ (F級)	AEC-Q200 Test 16/MIL-STD-202 Method 107 -55°C(15分鐘) ~ 常溫( $\leq 20$ 秒) ~ 155°C(15分鐘)，300個循環。 -55°C(15min) ~ normal temperature( $\leq 20$ s) ~ 155°C(15min) , 300 cycles.
ESD 靜電放電 Electrostatic Discharge (ESD)	無可見損傷 No mechanical damage $\Delta R \leq \pm(3.0\%R+0.05\Omega)$	無可見損傷 No mechanical damage $R \leq 50\text{ m}\Omega$ (J級) $R \leq 20\text{ m}\Omega$ (G級) $R \leq 10\text{ m}\Omega$ (F級)	AEC-Q200 Test 17/AEC-Q200-002 人體模式，兩次放電，正、負極性各1次。 Human body model, 1pos + 1neg. discharges. 0201:0.5kV;0402/0603; 1kV ;0805; 2kV;1206及以上: 3kV.

**● 特性 Characteristics**

( 續上頁 Continue )

項目 Item	標準 Specifications		測試方法 Test Methods
	片式電阻器 Resistor	跨接電阻 Jumper	
可焊性 Solderability	無可見損傷 No mechanical damage 可焊面積 > 95% 95% Cover Min		AEC-Q200 Test 18/IEC 60115-1 4.17 245°C ± 5°C 錫槽, 保持3s ± 0.3s. Lead-free solder bath at 245°C ± 5°C for 3s ± 0.3s.
電阻溫度係數 T.C.R	在規定值內 Within specified T.C.R	/	AEC-Q200 Test 19/IEC 60115-1 4.8 +20°C/-55°C/+20°C/+125°C/+20°C
可燃性 Flammability	不完全燃盡, 薄墊紙應不被引燃, 松木板應不被烤焦炭化。 No ignition of the tissue paper or scorching or the pinewood board.		AEC-Q200 Test 20/UL-94 V-0或V-1可接受。不需要電氣測試。 V-0 or V-1 are acceptable. Electrical test not required.
基板彎曲試驗 Substrate Bending Test	無可見損傷 No mechanical damage 0.5%, 1%: $\Delta R \leq \pm(0.5\%R+0.05\Omega)$ 2%, 5%, 10%: $\Delta R \leq \pm(1.0\%R+0.05\Omega)$	無可見損傷 No mechanical damage $R \leq 50 \text{ m}\Omega$ (J級) $R \leq 20 \text{ m}\Omega$ (G級) $R \leq 10 \text{ m}\Omega$ (F級)	AEC-Q200 Test 21/AEC-Q200-005 彎曲距離(Bending distance): 0201, 0402, 0603, 0805: 5mm; 1206, 1210: 4mm; 2010, 2512: 2mm 保持時間(Duration): 60s ± 5s
端子強度 Terminal Strength	無可見損傷 No mechanical damage 0.5%, 1%: $\Delta R \leq \pm(0.5\%R+0.05\Omega)$ 2%, 5%, 10%: $\Delta R \leq \pm(1.0\%R+0.05\Omega)$	無可見損傷 No mechanical damage $R \leq 50 \text{ m}\Omega$ (J級) $R \leq 20 \text{ m}\Omega$ (G級) $R \leq 10 \text{ m}\Omega$ (F級)	AEC-Q200 Test 22/AEC-Q200-006 0201施加力: 2N, 保持60 ± 1秒。 0402施加力: 5N, 保持60 ± 1秒。 0603及以上施加力: 17.7N, 保持 60 ± 1秒。 For 0201: Applying force 2N for 60s ± 1s. For 0402: Applying force 5N for 60s ± 1s. For 0603 and above size: Applying force 17.7N for 60s ± 1s.
阻燃性 Flame Retardance	不可燃 No flame		AEC-Q200 Test 24/AEC-Q200-001 9Vdc 到 32Vdc ( 鉗位電流高達 500A )、增量為 1.0Vdc 的電壓。 每種電壓等級最少施加1小時。 Subjected to voltage from 9.0 to 32.0 VDC(current clamped up to 500A), and each voltage level shall be increased in 1.0 VDC for one hour minimum.
絕緣電阻 Insulation Resistance	1000MΩ Min		IEC 60115-1 4.6 在電極與基片間施加100V ± 15V直流電壓, 保持1分鐘, 然後測絕緣電阻值。 Apply DC 100V ± 15V between substrate and terminations for 1min, then check insulation resistance.
耐電壓 Voltage Proof	無擊穿或飛弧 No breakdown or flashover		IEC 60115-1 4.7 在電極與基片間以大約100V/s的速率施加有效值為最大過負荷電壓的交流電壓, 保持60s ± 5s。 Apply max. overload voltage of AC RMS at a rate of approximately 100V/s between substrate and terminations for 60s ± 5s.
短時間過負載 Short Time Overload	無可見損傷 No mechanical damage 0.5%, 1%: $\Delta R \leq \pm(1.0\%R+0.05\Omega)$ 2%, 5%, 10%: $\Delta R \leq \pm(2.0\%R+0.05\Omega)$	無可見損傷 No mechanical damage $R \leq 50 \text{ m}\Omega$ (J級) $R \leq 20 \text{ m}\Omega$ (G級) $R \leq 10 \text{ m}\Omega$ (F級)	IEC 60115-1 4.13 2.5倍額定電壓或最大過負荷電壓/電流(取較小值), 持續5秒。 2.5 times rated voltage or max. overload voltage(current) whichever is lower for 5s.
低溫負載 Operation at Low Temperature	無可見損傷 No mechanical damage 0.5%, 1%: $\Delta R \leq \pm(1.0\%R+0.05\Omega)$ 2%, 5%, 10%: $\Delta R \leq \pm(2.0\%R+0.05\Omega)$	無可見損傷 No mechanical damage $R \leq 50 \text{ m}\Omega$ (J級) $R \leq 20 \text{ m}\Omega$ (G級) $R \leq 10 \text{ m}\Omega$ (F級)	IEC 60115-1 4.36 -55°C ± 5°C, 無負載1小時, 額定電壓(電流)或元件極限電壓(取較小值)45分鐘, 無負載15分鐘。 -55°C ± 5°C, 1h without load, rated voltage(current) or limiting element voltage whichever is lower for 45min, 15min without load.
抗硫化性能 Sulfuration Resistant	無可見損傷 No mechanical damage $\Delta R \leq \pm(5.0\%R+0.05\Omega)$	無可見損傷 No mechanical damage $R \leq 100 \text{ m}\Omega$ (J級) $R \leq 40 \text{ m}\Omega$ (G級) $R \leq 20 \text{ m}\Omega$ (F級)	油浴, 恆溫: 105°C ± 3°C, 放置時間: 240小時 Oil bath for 240 hours, 105°C ± 3°C, unpowered.

**● 包裝 Packaging**

包裝方式見附錄 Packaging see the Appendix.

## 附錄 Appendix

### ■ 推薦焊盤尺寸 Recommend Solder Pad Size

- 片式固定電阻器 Chip fixed resistor

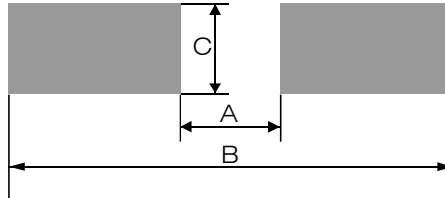

單位 unit: mm

厚膜電阻及薄膜電阻 Thick Film Resistor and Thin Film Resistor			
型號 Type	A	B	C
01005	0.17 ± 0.03	0.60 ± 0.03	0.22 ± 0.03
0201	0.23 ± 0.05	0.84 ± 0.05	0.38 ± 0.05
0402	0.45 ± 0.05	1.45 ± 0.05	0.60 ± 0.05
0603	0.80 ± 0.05	2.50 ± 0.05	0.95 ± 0.05
0805	1.05 ± 0.1	3.25 ± 0.1	1.40 ± 0.1
1206	1.90 ± 0.1	4.50 ± 0.1	1.75 ± 0.1
1210	2.00 ± 0.1	4.60 ± 0.1	2.70 ± 0.1
2010	3.50 ± 0.1	6.50 ± 0.1	2.70 ± 0.1
2512	4.80 ± 0.1	7.80 ± 0.1	3.40 ± 0.1
2512 (2W)	2.70 ± 0.1	7.80 ± 0.1	3.60 ± 0.1

- 厚膜片式網絡電阻器 Thick film chip network resistor

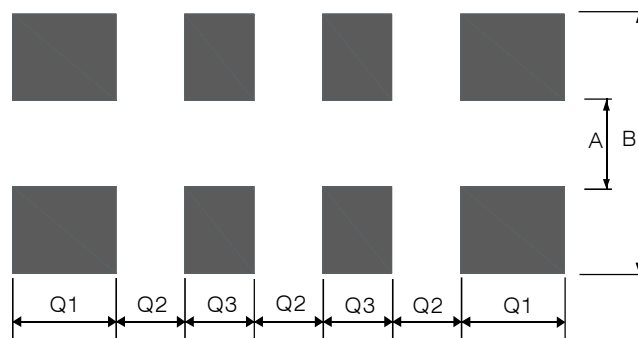

RCMY08 / RCMT08 / RCML08

單位 unit: mm

型號 Type	A	B	Q1	Q2	Q3
RCMY08	0.30 ± 0.05	0.90 ± 0.05	0.20 ± 0.05	0.20 ± 0.05	0.20 ± 0.05
RCMT08	0.38 ± 0.05	1.60 ± 0.05	0.40 ± 0.05	0.20 ± 0.05	0.30 ± 0.05
RCML08	0.80 ± 0.05	2.70 ± 0.05	0.60 ± 0.05	0.40 ± 0.05	0.40 ± 0.05

## ■ 包装 Packaging

### ● 紙帶編帶 Paper Taping

適用於01005、0201、0402、RCMY08、RCMT08；

For 01005、0201、0402、RCMY08、RCMT08；

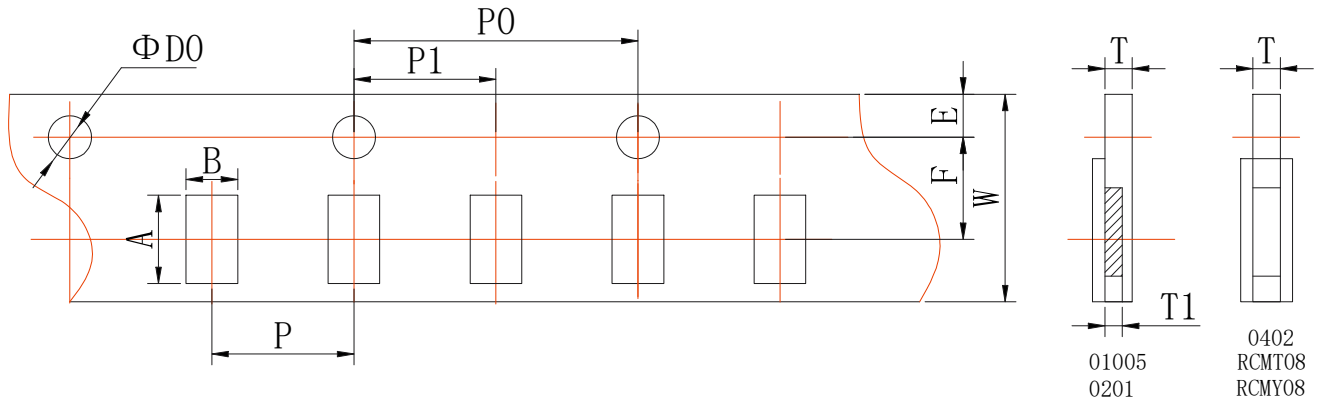

單位 unit: mm

型號 Type	A	B	W	F	E
01005	0.45±0.02	0.25±0.02	8.00±0.02	3.50±0.05	1.75±0.05
0201	0.70±0.10	0.40±0.10	8.00±0.20	3.50±0.05	1.75±0.10
0402	1.20±0.10	0.70±0.10	8.00±0.20	3.50±0.05	1.75±0.10
RCMY08	1.57±0.05	0.77±0.05	8.00±0.20	3.50±0.05	1.75±0.10
RCMT08	2.20±0.10	1.20±0.10	8.00±0.20	3.50±0.05	1.75±0.10

單位 unit: mm

型號 Type	P	P0	P1	ΦD0	T1	T
01005	2.00±0.05	4.00±0.10	2.00±0.05	1.55±0.02	0.17±0.02	0.31±0.02
0201	2.00±0.05	4.00±0.10	2.00±0.05	1.50±0.10	0.28±0.04	0.42±0.05
0402	2.00±0.05	4.00±0.10	2.00±0.05	1.50±0.10	/	0.42±0.05
RCMY08	2.00±0.05	4.00±0.10	2.00±0.05	1.50±0.10	/	0.60±0.10
RCMT08	2.00±0.10	4.00±0.10	2.00±0.05	1.50±0.10	/	0.60±0.10

適用於0603、0805、1206、1210、RCML08；

For 0603、0805、1206、1210、RCML08；

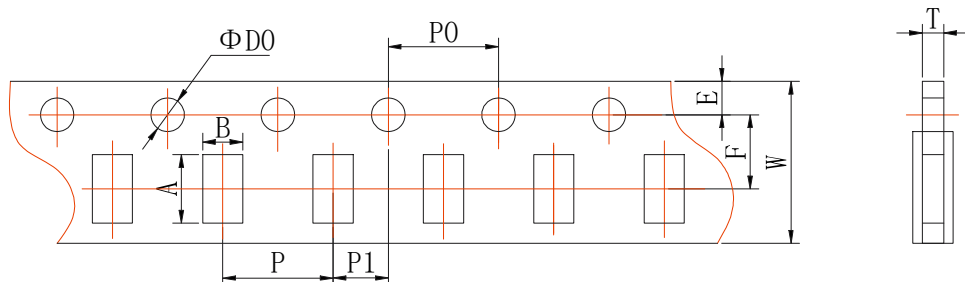

# 片式電阻包裝方式及注意事項

## PACKAGING AND PRECAUTION OF CHIP RESISTOR

單位 unit: mm

型號 Type	A	B	W	F	E
0603	$1.85 \pm 0.10$	$1.10 \pm 0.10$	$8.00 \pm 0.20$	$3.50 \pm 0.05$	$1.75 \pm 0.10$
0805	$2.35 \pm 0.10$	$1.65 \pm 0.10$	$8.00 \pm 0.20$	$3.50 \pm 0.05$	$1.75 \pm 0.10$
1206	$3.50 \pm 0.20$	$1.90 \pm 0.20$	$8.00 \pm 0.20$	$3.50 \pm 0.05$	$1.75 \pm 0.10$
1210	$3.50 \pm 0.20$	$2.80 \pm 0.20$	$8.00 \pm 0.20$	$3.50 \pm 0.05$	$1.75 \pm 0.10$
RCML08	$3.50 \pm 0.20$	$1.90 \pm 0.20$	$8.00 \pm 0.20$	$3.50 \pm 0.05$	$1.75 \pm 0.10$

單位 unit: mm

型號 Type	P	P0	P1	$\Phi D0$	T	
					厚膜電阻及薄膜電阻 Thick Film Resistor and Thin Film Resistor	合金片式固定電阻 Metal Foil Resistor
0603	$4.00 \pm 0.10$	$4.00 \pm 0.10$	$2.00 \pm 0.05$	$1.50 \pm 0.10$	$0.60 \pm 0.10$	$0.75 \pm 0.10$
0805	$4.00 \pm 0.10$	$4.00 \pm 0.10$	$2.00 \pm 0.05$	$1.50 \pm 0.10$	$0.75 \pm 0.10$	$0.95 \pm 0.10$
1206	$4.00 \pm 0.10$	$4.00 \pm 0.10$	$2.00 \pm 0.05$	$1.50 \pm 0.10$	$0.75 \pm 0.10$	$0.95 \pm 0.10$
1210	$4.00 \pm 0.10$	$4.00 \pm 0.10$	$2.00 \pm 0.05$	$1.50 \pm 0.10$	$0.75 \pm 0.10$	---
RCML08	$4.00 \pm 0.10$	$4.00 \pm 0.10$	$2.00 \pm 0.05$	$1.50 \pm 0.10$	$0.75 \pm 0.10$	---

### ● 塑料帶編帶 Embossed Taping

適用於2010、2512:

For 2010、2512:

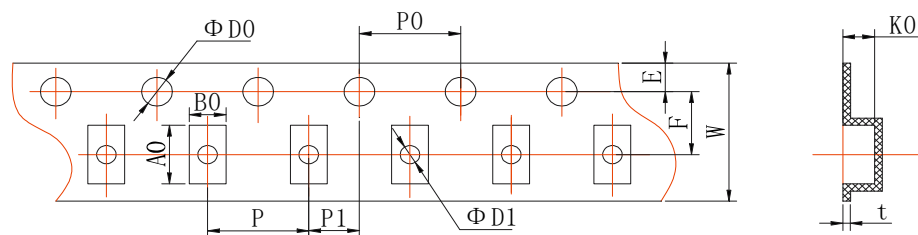

單位 unit: mm

型號 Type	A0	B0	W	F	E	t
2010	$5.50 \pm 0.15$	$2.82 \pm 0.15$	$12.00 \pm 0.10$	$5.50 \pm 0.10$	$1.75 \pm 0.10$	$0.25 \pm 0.05$
2512	$6.78 \pm 0.15$	$3.45 \pm 0.15$	$12.00 \pm 0.10$	$5.50 \pm 0.10$	$1.75 \pm 0.10$	$0.25 \pm 0.05$

單位 unit: mm

型號 Type	P	P0	P1	$\Phi D0$	$\Phi D1$	K0	
						厚膜電阻及薄膜電阻 Thick Film Resistor and Thin Film Resistor	合金片式固定電阻 Metal Foil Resistor
2010	$4.00 \pm 0.10$	$4.00 \pm 0.10$	$2.00 \pm 0.05$	$1.50 \pm 0.10 / -0$	$1.50 \pm 0.10$	$0.84 \pm 0.10$	$0.84 \pm 0.10$
2512	$4.00 \pm 0.10$	$4.00 \pm 0.10$	$2.00 \pm 0.05$	$1.50 \pm 0.10 / -0$	$1.50 \pm 0.10$	$0.81 \pm 0.10$	$1.00 \pm 0.10$



● 卷盤 Reel

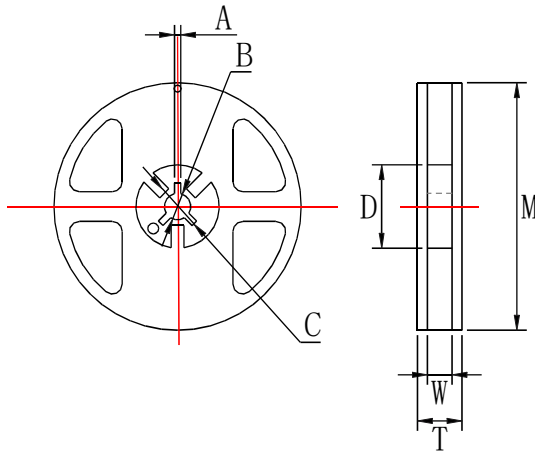

單位 unit: mm

型號 Type	M	W	T	A	B	C	D
01005、0201 0402、0603 0805、1206 1210、RCMY08、 RCMT08、RCML08	178±2.0	9.5±1.0	12.5±1.5	2.0±0.5	13.0±0.5	21.0±0.5	58.0±2.0
2010、2512	178±2.0	13.0±0.5	15.5±1.5	2.0±0.5	13.0±0.5	21.0±0.5	57.0±2.0

● 編帶包裝能力 Taping Ability

面帶拉力 Top tape peel strength

面帶拉力强度未11~70g( 0.1N~0.7N) ， 速度：300mm/min,經下列試驗后不允許有破裂斷帶現象。

Peel strength is 11~70g (0.1N~0.7N),with speed of 300mm/min,and should not have flash and tear after peeling.

測試方法 Test method:

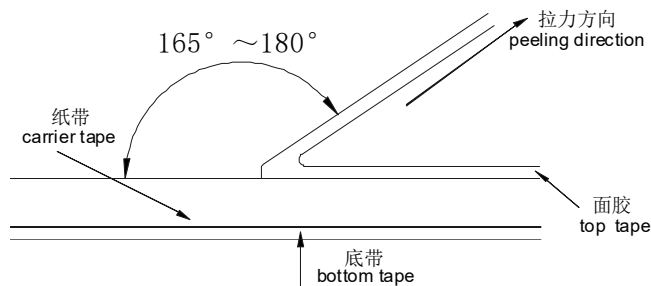

電阻松動自如，無粘面膠帶、底膠帶現象。

Resistor is free, no sticking to top tape and bottom tape.

電阻易從紙帶中取出，且晶片孔無機械損傷。

Resistor is easy to take out from carrier tape and chip hole have no mechanical damage.

# 片式電阻包裝方式及注意事項

## PACKAGING AND PRECAUTION OF CHIP RESISTOR

### ● 包裝數量 Packaging Quantity

包裝方法 Packaging style	編帶 Tape & reel				塑料袋散裝 Case		
型號 Type	01005	0201, 0402 RCMY08, RCMT08	0603, 0805 1206, 1210 RCML08	2010 2512	01005 0201 0402	0603, 0805 1206, RCMY08, RCMT08, RCML08	1210 2010 2512
數量 Quantity(pcs)	20000	10000	5000	4000	≤50000	≤10000	≤4000

### ■ IEC E-24、E-96系列電阻值代碼對照表

#### IEC E-24、E-96 Series Resistance Cross-reference List

#### ● E-24 系列 E-24 series ( $\times 10^n \Omega$ )

(單位 unit: 0.001 $\Omega$ 、0.01 $\Omega$ 、0.1 $\Omega$ 、1 $\Omega$ 、10 $\Omega$ 、100 $\Omega$ 、1k $\Omega$ 、10k $\Omega$ 、100k $\Omega$ 、1M $\Omega$ 、10M $\Omega$ 、100M $\Omega$ 、1000M $\Omega$ )

表一 Table One:

1.0	1.5	2.2	3.3	4.7	6.8
1.1	1.6	2.4	3.6	5.1	7.5
1.2	1.8	2.7	3.9	5.6	8.2
1.3	2.0	3.0	4.3	6.2	9.1

#### ● E-96系列 E-96 series ( $\times 10^n \Omega$ )

(單位unit: 0.001 $\Omega$ 、0.01 $\Omega$ 、0.1 $\Omega$ 、1 $\Omega$ 、10 $\Omega$ 、100 $\Omega$ 、1k $\Omega$ 、10k $\Omega$ 、100k $\Omega$ 、1M $\Omega$ 、10M $\Omega$ 、100M $\Omega$ 、1000M $\Omega$ )

表二 Table Two:

1.00	1.33	1.78	2.37	3.16	4.22	5.62	7.50
1.02	1.37	1.82	2.43	3.24	4.32	5.76	7.68
1.05	1.40	1.87	2.49	3.32	4.42	5.90	7.87
1.07	1.43	1.91	2.55	3.40	4.53	6.04	8.06
1.10	1.47	1.96	2.61	3.48	4.64	6.19	8.25
1.13	1.50	2.00	2.67	3.57	4.75	6.34	8.45
1.15	1.54	2.05	2.74	3.65	4.87	6.49	8.66
1.18	1.58	2.10	2.80	3.74	4.99	6.65	8.87
1.21	1.62	2.15	2.87	3.83	5.11	6.81	9.09
1.24	1.65	2.21	2.94	3.92	5.23	6.98	9.31
1.27	1.69	2.26	3.01	4.02	5.36	7.15	9.53
1.30	1.74	2.32	3.09	4.12	5.49	7.32	9.76

● E-96系列0603型號《乘數代碼對照表》及《電阻值代碼對照表》

E-96 series(0603)《multiplied Cross-reference List》and《Resistance Cross-reference List》

表三 Table Three:

乘數multiplied	$\times 10^0$	$\times 10^1$	$\times 10^2$	$\times 10^3$	$\times 10^4$	$\times 10^5$	$\times 10^6$	$\times 10^7$	$\times 10^{-1}$	$\times 10^{-2}$	$\times 10^{-3}$
代碼 code	A	B	C	D	E	F	G	H	X	Y	Z

表四 Table Four:

代號 Code	E-96系列電阻 E-96 resistance	代號 Code	E-96系列電阻 E-96 resistance	代號 Code	E-96系列電阻 E-96 resistance	代號 Code	E-96系列電阻 E-96 resistance
01	100	25	178	49	316	73	562
02	102	26	182	50	324	74	576
03	105	27	187	51	332	75	590
04	107	28	191	52	340	76	604
05	110	29	196	53	348	77	619
06	113	30	200	54	357	78	634
07	115	31	205	55	365	79	649
08	118	32	210	56	374	80	665
09	121	33	215	57	383	81	681
10	124	34	221	58	392	82	698
11	127	35	226	59	402	83	715
12	130	36	232	60	412	84	732
13	133	37	237	61	422	85	750
14	137	38	243	62	432	86	768
15	140	39	249	63	442	87	787
16	143	40	255	64	453	88	806
17	147	41	261	65	464	89	825
18	150	42	267	66	475	90	845
19	154	43	274	67	487	91	866
20	158	44	280	68	499	92	887
21	162	45	287	69	511	93	909
22	165	46	294	70	523	94	931
23	169	47	301	71	536	95	953
24	174	48	309	72	549	96	976

### ■ 厚膜電阻阻值代碼及標記規則

#### Description for Resistance Value Code and Marking of Thick Film Chip Resistor

- 阻值代碼 Resistance Value Code



所有厚膜電阻的阻值代碼與其標記是相對應的。

All the resistance value code of thick film chip resistor is corresponding with the marking .

- 標記 Marking

\* E-24系列( $\geq 0603$ 、 $\geq \pm 5\%$ ): 採用三位數字表示, 前二位表示電阻值有效數字, 第三位表示乘以10的次方數。

E-24 series: Express resistance value on the glass side with three digits, the first two digits should be significant and the third one denote number of zeros.

例 For example:  

\* E-24系列 ( $0603$ 、 $\leq \pm 1\%$ ): 在三位數字標記下方增加下橫綫識別。

E-24 series( $0603$ 、 $\leq \pm 1\%$ ): Three digits with one short bar under marking letter.

例 For example: 

\* E-96系列和E24系列 ( $\geq 0805$ 、 $\leq \pm 1\%$ ):

▲ 採用四位數字表示, 前三位表示電阻值有效數字, 第四位表示乘以10的次方數。

E-96 series & E-24 series ( $\geq 0805$ 、 $\leq \pm 1\%$ ):

Express the resistance value with four digits, the first three digits are significant figures and the fourth denotes the number of zeros.

例 For example: 

\* E-96系列 ( $0603$ 、 $\leq \pm 1\%$ ):

▲ 採用三位代碼表示, 前二位表示E-96系列阻值代碼, 後一位字母表示乘數代碼(見表三和表四)。

Express the resistance value with three code, the first two digit code denote the resistance of E-96 series, and the third code of letter denote the multiplier



(see the table three and four).

例 For example: 

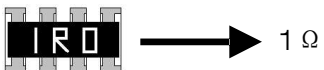
\* 小數點以“R”表示 The decimal point should be expressed by “R” .

例 For example:  

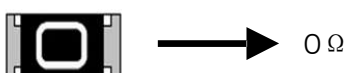
\* 跨接電阻以“0”表示 The jumper should be expressed by “0”

例 For example:  

\*  $\leq 0402$ 產品不作標記 For the chip resistor( $\leq 0402$ ), there is no mark on the glass side.

例 For example: 

\* 非IEC標準系列的電阻值標記表示方法: 一般以最接近IEC E24系列標稱阻值的標記表示方法。

For the resistance which don't belong to IEC serial, use the resistance of IEC serial which is most close to the required resistance of non-IEC serial for replacement.

\* 客戶對標記有特殊要求時, 則按照協商的結果印刷標記。

To get agreement by both party if there special requirement for the marking.

## ■ 薄膜電阻阻值代碼及標記規則

### Description for Resistance Value Code and Marking of Thin Film Chip Resistor

- 阻值代碼 Resistance Value Code

所有薄膜電阻全尺寸統一採用四位數阻值代碼表示。

All resistance value code of thin film chip resistor used four digits.

例 Example

TD03G4701BT

四位數代號表示，如：4701=4.7KΩ；1R50=1.5Ω

To use four digits code represent resistance value，

例 Example 4701=4.7KΩ；1R50=1.5Ω

- 標記 Marking

\* 當阻值同時存在于E24和E96系列時，優先採用E96系列。

When resistance value belongs to E24 as well as E96 series, we suggest preferentially use E96 series.

例 Example 10K=1002, ≠103

\* ≥0805 產品標記 For the chip resistor (≥0805):

▲ 印刷四位數字代碼；

Express the resistance value with four digits code;

例 Example



\* 0603標記 Marking for 0603 Size Resistor

▲ 0603-E96系列：印刷三位字母代碼；

For resistance value belongs to E96 series, express the resistance value with three digits code.

例 Example



▲ 0603-E24系列：印刷三位數字代碼，

For resistance value belongs to E24 series, express the resistance value with three digits code.

例 Example



\* ▲ 小數點以"R"表示 The decimal point should be expressed by"R".

例 Example



\* ≤0402產品：不作標記 For the chip resistor (≤0402), there is no mark on the glass side.

例 Example



### ■ 電流檢測電阻阻值代碼及標記規則

#### Description for Resistance Value Code and Marking of Current Sensing Thick Film Chip Resistor

##### ● 阻值代碼 Resistance Value Code

所有電流檢測電阻全尺寸統一採用四位數阻值代碼表示。

All resistance value code of current sensing thick film chip resistor used four digits.

例 Example

RBF03MR010FT

四位數代號表示，如：R010=10mΩ；30M1=30.1mΩ

To use four digits code represent resistance value，

例 Example R010=10mΩ；30M1=30.1mΩ

##### ● 標記 Marking

\* E-24和E-96系列(≥0805、≤±5%)：採用四位標記代碼。

For the chip resistor (≥0805、≤±5%)，when resistance value belongs to E24 and E96 series，we suggest preferentially use four digits.

標記代碼 Mark Code	阻值範圍 Resistance Value	示例 Sample
R00X	1mΩ ≤ R ≤ 9mΩ	R005=5mΩ
R0XX	10mΩ ≤ R ≤ 99mΩ	R033=33mΩ
RXXX	100mΩ ≤ R ≤ 999mΩ	R100=100mΩ
XMXX	1mΩ < R < 10mΩ ( 包含小數點后兩位有效數字 ) (Contains two significant digits after the decimal point.)	5M10=5.1mΩ
XXMX	10mΩ < R < 100mΩ ( 包含小數點后一位有效數字 ) (Contains one significant digit after the decimal point.)	30M1=30.1mΩ

\* E-24和E-96系列(0603、≤±5%)：採用三位標記代碼。

For the chip resistor (0603、≤±5%)，when resistance value belongs to E24 and E96 series，we suggest preferentially use three digits.

標記代碼 Mark Code	阻值範圍 Resistance Value Range	示例 Sample
V0X	1mΩ ≤ R ≤ 9mΩ	V05=5mΩ
VXX	10mΩ ≤ R ≤ 99mΩ	V33=33mΩ
RXX	100mΩ ≤ R ≤ 999mΩ	R10=100mΩ
XXM	1mΩ < R < 10mΩ ( 包含小數點后一位有效數字 ) (Contains one significant digit after the decimal point.)	5M1=5.1mΩ

\* ≤0402產品不印刷標記。

For the chip resistor (≤0402)，there is no mark on the glass side.

\* 非IEC標準系列的電阻值標記表示方法：一般以最接近IEC E24系列標稱阻值的標記表示方法。

For the resistance which don't belong to IEC serial，use the resistance of IEC serial which is most close to the required resistance of non-IEC serial for replacement.

\* 客戶對標記有特殊要求時，則按照協商的結果印刷標記。

To get agreement by both party if there special requirement for the marking.

## ■ 片式電阻器使用說明 Chip Resistor Instructions for Use

### ● 本產品在以下特殊環境下應用，性能可能會受到影響：

- 1、在各種類型的液體，包括水、油、化學品、有機溶劑的使用。
- 2、在戶外直接暴露在陽光的地方，或在灰塵多的地方使用。
- 3、在產品暴露的地方，有海風或腐蝕性氣體，包括氯氣、硫化氫、氨氣、二氧化硫、二氧化氮等。
- 4、在產品暴露于靜電或電磁波的地方使用。
- 5、在產生熱量的部件、塑料綫，或其他易燃物品附近使用。
- 6、在用樹脂或其他塗層材料密封產品的情況下使用。
- 7、焊接後使用不潔焊料或使用水或水溶性清洗劑清洗產品。
- 8、片狀電阻器的基材是氧化鋁。由于和安裝基板的熱膨脹系數不同，在反復施加提供熱循環等熱應力時，接合部的焊錫（焊縫部）有時會發生裂紋。如果環境溫度反復發生很大的變動，并且載荷反復進行ON/OFF，則需要注意龜裂的發生。因熱應力而發生的龜裂，取決于所安裝的焊盤的大小、焊錫量、安裝基板的散熱性等，因此在環境溫度有很大的變化或載荷ON/OFF的條件下使用時，請充分注意以進行設計。

### ● Application of the products in a special environment can deteriorate product performance:

- 1、Use in various types of liquid, including water, oils, chemicals, and organic solvents.
- 2、Use outdoors where the products are exposed to direct sunlight, or in dusty places.
- 3、Use in places where the products are exposed to sea winds or corrosive gases, including  $Cl_2$ ,  $H_2S$ ,  $NH_3$ ,  $SO_2$ , and  $No_2$  etc.
- 4、Use in places where the products are exposed to static electricity or electromagnetic waves.
- 5、Use in proximity to heat-producing components, plastic cords, or other flammable items.
- 6、Use involving sealing or coating the products with resin or other coating materials.
- 7、Use involving unclean solder or use of water or water-soluble cleaning agents for cleaning after soldering.
- 8、The substrate of chip resistors is alumina. Cracks may occur at the connection of solder (solder fillet portion) due to the difference of the coefficient of thermal expansion from a mounting board when heat stress like heat cycle, etc. are repeatedly given to them. Care should be taken to the occurrence of the cracks when the change in ambient temperature or ON/OFF of load is repeated. The occurrence of the crack by heat stress may be influenced by the size of a pad, solder volume, heat radiation of mounting board etc., so please pay careful attention to designing when a big change in ambient temperature and conditions for use like ON/OFF of load can be assumed.

### ● 產品使用注意事項

- 1、避免采用超過正常額定功率的功率，超過額定功率的穩態負載條件下可能會對產品性能和可靠性產生負面影響。
- 2、用鑷子拿起產品時要小心，有可能會將保護或電阻體夾碎。
- 3、手動安裝產品時，烙鐵頭勿觸碰產品。
- 4、貯存條件：溫度  $5^{\circ}C \sim 30^{\circ}C$ ，相對濕度30%~70%。  
建議在符合上述儲存條件下六個月內使用。
- 5、用于車載設備、醫療設備、航空設備以及其它涉及人身安全、或可能引起重大損失的設備上時，請務必事先與我公司聯系。這些產品在這類用途中出現故障或失靈可能導致人身事故或嚴重損壞。

### ● Precautions on use of products

- 1、Avoid applying power exceeding normal rated power, exceeding the power rating under steady-state loading condition may negatively affect product performance and reliability.
- 2、Be careful when pick up the products with tweezers. There may be a care that the overcoat and / or the body can be chipped.
- 3、Soldering tip shall not touch the product when install product manually.
- 4、Storage conditions: T:  $5^{\circ}C \sim 30^{\circ}C$ , RH: 30%~70%.  
The products are suggested to be used within six months when received, and the storage condition mentioned above should be followed.
- 5、Contact our sales representatives before you use our products for applications including automotive, medical equipment and aerospace equipment. Malfunction or failure of the products in such applications may cause loss of human life or serious damage.

### ■ 焊接 Soldering

- 推薦的回流焊曲線 Recommended reflow profile
- 推薦的波峰焊曲線 Recommended wave solder profile

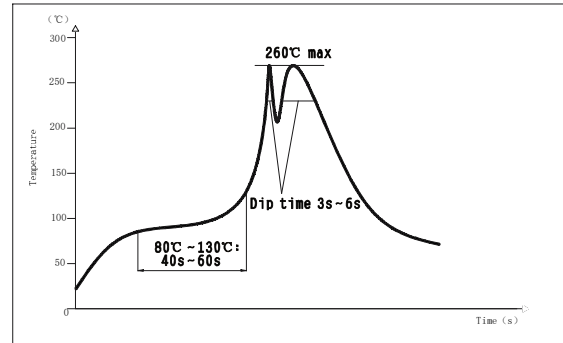
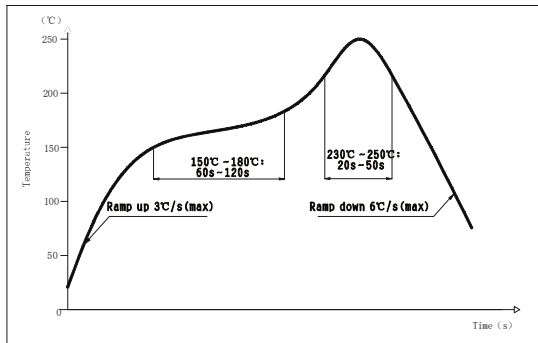

- 推薦的焊膏類型 Recommended solder alloy: 96.5Sn/3.0Ag/0.5Cu

### ■ 修訂履歷 Revision History

版本Version	日期Date	修訂內容 Change Description	修改確認 Checked by
V2020.0	2020-06-23	- 原版 The original version.	吳曉玲 Xiaoling Wu
V2020.1.0	2020-09-30	- 增加0201尺寸產品的參數 Add the parameters of 0201 chip resistor.	王躍偉 Yuewei Wang
V2020.2.0	2021-02-24	- 刪除 E-24系列 客戶特殊要求標記說明 Delete marking instructions for special requirements of customers	杜建業 Jianye Du
V3.0	2021-8-13	- 增加“應用領域”。 Add the application. - 附錄中“推薦焊盤尺寸”：增加偏差值。 Add the tolerance to Recommend Solder Pad Size.	盧振強 Zhenqiang Lu

注：上述所提供之內容為產品規格說明。在產品未變更時，風華保有修改此內容不另行通知之所有權利，任何產品變更將會以PCN通知客戶。

Remark: Information provided above is intended to indicate product specifications only. Fenghua reserves all the rights for revising this content without further notification, as long as products are unchanged. Any product change will be announced by PCN.



## X-ON Electronics

Largest Supplier of Electrical and Electronic Components

*Click to view similar products for* [Thick Film Resistors - SMD category:](#)

*Click to view products by* [Fenghua Advanced manufacturer:](#)

Other Similar products are found below :

[CR-05FL7--150R](#) [CR-05FL7--698K](#) [CR-12JP4--680R](#) [CRCW04021K20FKEE](#) [CRCW04028R20JNEE](#) [CRCW06032K10FKEC](#)  
[CRCW06036K80FKEE](#) [M55342K03B499DRS6](#) [M55342K06B6E19RWL](#) [M55342K09B5D62RS6](#) [M55342M06B26E7RS3](#) [742C083750JTR](#)  
[MCR01MRTF1001](#) [MCR01MZPF1202](#) [MCR01MZPF1601](#) [MCR01MZPF1800](#) [MCR01MZPF6201](#) [MCR01MZPF9102](#) [MCR01MZPJ121](#)  
[MCR01MZPJ125](#) [MCR01MZPJ751](#) [MCR03EZHZ103](#) [MCR03EZPF2004](#) [MCR03EZPJ270](#) [MCR03EZPJ821](#) [MCR10EZPF1102](#)  
[MCR10EZPF2700](#) [MCR18EZPJ330](#) [RC1005F1152CS](#) [RC1005F1372CS](#) [RC1005F2052CS](#) [RC1005F471CS](#) [RC1005F4751CS](#)  
[RC1005F5621CS](#) [RC1005F6041CS](#) [RC1005J121CS](#) [RC1005J122CS](#) [RC1005J180CS](#) [RC1005J181CS](#) [RC1005J202CS](#) [RC1005J391CS](#)  
[RC1005J512CS](#) [RC1005J683CS](#) [RC1005J823CS](#) [RC1608F333CS](#) [RC1608F5110CS](#) [RC1608J121CS](#) [RC2012F2493CS](#) [RC2012F2740CS](#)  
[RC2012J105CS](#)