

圓片瓷介電容器 CERAMIC DISC CAPACITOR

● 產品規格表示方式 Product Part Number Expression

$\frac{CT81}{1}$ — $\frac{M}{2}$ — $\frac{5}{3}$ — $\frac{Y5V}{4}$ — $\frac{5}{5}$ — $\frac{B}{6}$ — $\frac{102}{7}$ — $\frac{M}{8}$ — $\frac{T}{9}$ — $\frac{E}{10}$

1、產品類型 Product Type

類型代號 Type code	產品類型 Product Type	
CC81	高壓溫度補償型	High voltage temperature compensation capacitor
CT1	低壓高介電常數型	Low voltage high dielectric constant disk ceramic capacitor
CT81	高壓高介電常數型	High voltage high dielectric constant disk ceramic capacitor
CS1	半導體型電容器	Semiconductor disk ceramic capacitor
CT7	交流電容器	Alternating current disk ceramic capacitor

2、電壓代碼 Voltage Code

代碼 Code	F	L	N	M	P	Q	S	U	W	Z	X	Y
額定電壓 Rated Voltage	50V	500V	1KV	2KV	3KV	4KV	6KV	8KV	10KV	15KV	250 VAC	400VAC

3、芯片直徑範圍代碼 The Code Chip Diameter Range

代碼 Code	5	6	...	10	12	...
直徑 Diameter(mm)	4.5-5.4	5.5-6.4	...	9.5-10.4	11.5-12.4	...

4、溫度特性(溫度系數及EIA代碼):

Temperature Characteristics (temperature coefficient and EIA code):

溫度特性 Temperature Characteristics		溫度範圍 Temperature range	容量允許偏差 Capacitance with temperature change rate
USE code	EIA code		
NPO	C0H	-25~-+85°C	0±60PPM/°C
N750	U2J		750±120PPM/°C
SL	S2L		+140~-1000PPM/°C
Y5P	Y5P		±10%
Y5R	Y5R		±15%
Y5U	Y5U		+22/-56%
Y5V	Y5V		+22/-82%



5、引綫形式 Lead style

代號 Code	引綫形式 lead Style
1	直脚(16-28mm) Straight lead (16~28m)
3	短脚(切脚) short lead(cut the feet)
4	編帶直脚型 Tape straight lead
5	編帶小內彎型 Tape small inside kink
6	編帶大內彎型 Tape large inside kink
7	特殊直脚 Special Straight lead
9	外單彎 Outside kink
0	前後翹 vertical kink lead

6、脚距 Lead Spacing

代碼 Code	B	D	E	K
脚距 Lead spacing (mm)	5.0±0.5	7.5±0.5	10.0±0.5	12.5±0.5

7、標稱容量 Standard capacitance

100	10PF	注：標稱容量以pF為單位，用3位數字表示。前兩位數字表示有效數字，第三位為0的個數。 Note: The unit of standard capacitance if consisting of 3 digits, the first and second digits stand for effective value of the Standard capacitance;third digit indicates the number of zeros.
560	56PF	
821	820PF	
102	1000PF	
-----	-----	

8、允許偏差 Capacitance Tolerance

代號 Code	K	M	Z
偏差 Tolerance	± 10%	± 20%	+80%~-20%

9、包裝形式 Packing style

代碼 Code	T	S
包裝形式 Packing style	編帶Taping	散裝 bulk

10、包封形式 Coating style

代號 code	E	P
包封形式 Coating style	環氧包封 Epoxy resin	酚醛包封Phenol resin

● 產品結構及外形尺寸 Product Structure and Overall Dimensions

直流產品正視圖

DC product front view

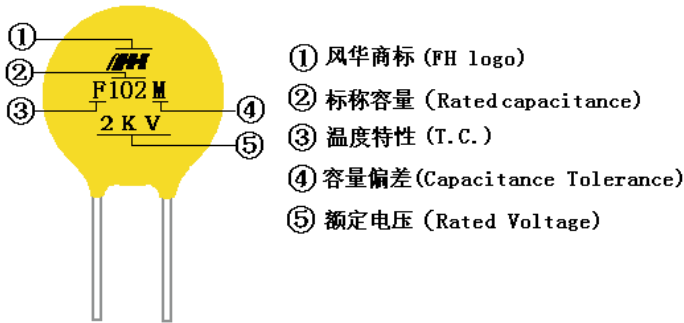

交流產品正視圖

AC product front view

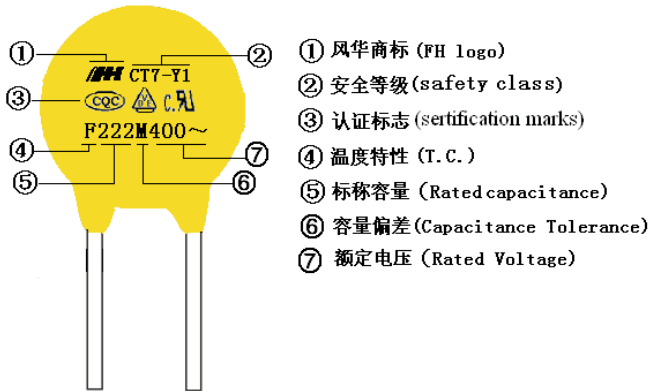

剖視圖 (sectional view)



● 引線形狀 Lead shape

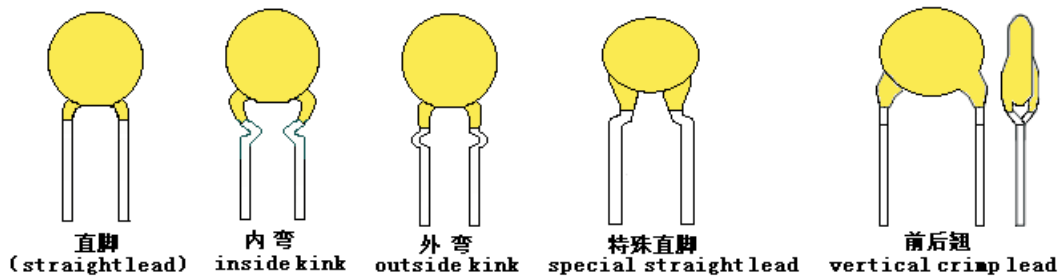

● 包裝形式 Packing style

1、散裝 Bulk

2、編帶產品 Taping products

2.1 編帶產品 Taping products ($P_0=12.7\text{mm}$, $F=5.0\text{mm}$, $F=7.5\text{mm}$)



2.2 編帶產品 Taping products ($P_0=15.0\text{mm}$, $F=7.5\text{mm}$)



2.3 編帶產品 Taping products ($P_0=15.0\text{mm}$, $F=10.0\text{mm}$)

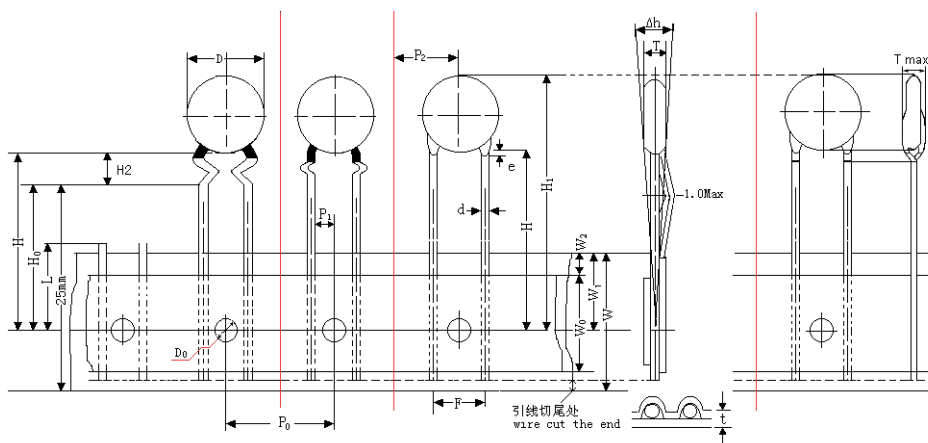

• 包裝形式 Packing style

3、產品包裝 products paking

引綫間距 Lead spacing	包裝形式 Packing style
F=5.0	散裝 Bulk、編帶 Taping(P0=12.7mm, D<10.0mm)
F=7.5	散裝 Bulk、 編帶 Taping(P0=12.7mm, D<10.0mm; P0=15.0mm, D<13.0mm)
F=10.0	散裝 Bulk、編帶 Taping(P0=15.0mm, D<13.0mm)
F=12.5	散裝 Bulk

包裝形式 Packing style	散裝 Bulk		編帶 Taping			
	D=4~9mm	D=9~13mm	F=5.0mm, P0=12.7mm	F=7.5mm, P0=12.7mm	F=7.5mm, P0=15.0mm	F=10.0mm, P0=15.0mm
最小包裝數量 Min packaging quantily	1K pcs	0.5K pcs	2K pcs	2K pcs	1.5K pcs	1K pcs

• 參數要求及測試條件
Parameter requirements and test conditions







序號 Number	項目 Item	性能要求 Performance requirement	檢測方法 Test method		
1	電容量 Capacitance	在規定允許公差之內 Within the specified Tolerance	測試頻率&測試電壓 Test Frequency&Test Voltage		
2	損耗因數 Dissipation Factor	CC81: $tg \delta \leq 0.0015$	CC81:1MHz/1.0Vrms		
		CT1、CT81、CT7: Y5R, $tg \delta \leq 0.025$; Y5P, $tg \delta \leq 0.025$; Y5U, Y5V, $tg \delta \leq 0.030$;	CT1、CT81、CT7:1KHz/1.0Vrms CS1:1KHz/0.1Vrms		
		CS1: $tg \delta \leq 0.050$;	測試溫濕度 Test temperature and humidity requirements : 25 ± 2℃, < 75%RH		
3	絕緣電阻 (IR) Insulation Resistance	CS1:1000MΩ Min CT1:4000MΩ Min CC81、CT81、CT7: 10000MΩ Min	額定電壓小於500VDC ,用額定電壓測試60秒。 Rated voltage is less than 500VDC, With rated voltage test 60 seconds. 額定電壓大於或等於500V ,用500VDC測試60秒。 Rated voltage is greater than the and so on In 500VDC, With 500 VDC test 60 seconds.		
4	端子間耐電壓 Resistance between terminal voltage	無擊穿 No breakdown	產品類型 Product Type	測試電壓 Test Voltage	充放電流 Charge/ discharge current : <50mA
			CT1	2.5UR	
			CC81、CT81	1.5UR+500V	
			CT7	10.0UR	
			CS1	1.5UR	
UR>10KVDC	1.1UR				

● 電路應用 circuit application

產品類型 Product Type	電路應用 circuit application
CC81	用于要求損耗值小、容量穩定性要求較高的電路中：諧振回路、高頻旁路、溫度補償、控制電路的時間常數元件、穩定性要求高的耦合元件。 Loss value for small and high capacitance stability circuit: the resonant circuit, high-frequency bypass, temperature compensation and control time constant of the circuit components, high stability requirements of coupling components.
CT1、CT81	用于對損耗值和容量穩定性要求不高的電路中，如低頻旁路、耦合、濾波、退耦等，時間常數元件。 Used for loss value and volume stability of circuits, such as low frequency, by-pass, coupling, filtering, decoupling, etc. the time constant of components.
CT7	交流瓷介電容器適于在電子設備中作為跨電源綫連接、天綫耦合和旁路等 In ac ceramic capacitor is suitable for electronic equipment as the power cord connection and antenna coupling and bypass, etc
CS1	適用於在耐壓較低的電路中作旁路和耦合、以及應用於寬帶信號和頻率分離的電路中。 Apply to circuits in the low pressure bypass and coupling, as well as the application in the broadband signal and frequency separation of circuits.

● 交流產品的安全認證

Communication products safety certification

序號 NO.	項目 Item	認證標記 Marking
1	CQC	
2	德國 VDE	
3	瑞士 SEV	
4	瑞典 SEMKO	
5	挪威 NEMKO	
6	丹麥 DEMKO	
7	芬蘭 FIMKO	
8	美國 UL	
9	CB 證書	CB

交流產品通過了的125°C 安全認證

Communication products has passed of 125 °C of safety

圓片瓷介電容器

CERAMIC DISC CAPACITOR

● 容量範圍 Capacitance Range:

產品類型 Product Type	額定電壓 Rated Voltage	溫度特性&容量範圍 (T.C.&Capacitance Range) pF			本體直徑 Body Diameter (mm)	本體厚度 Body Thickness (mm)	
		NPO	N750	SL (K)			
CC81	1KV	15-47 pF 根據客戶需求定制			18~47	6.5 Max	3.5 Max
					47~68	7.5 Max	4.0 Max
	2KV				18~47	6.5 Max	3.5 Max
					47~68	6.5 Max	4.0 Max
	3KV				18~47	6.5 Max	4.0 Max
					47~68	6.5 Max	4.5 Max
產品類型 Product Type	額定電壓 Rated Voltage	溫度特性&容量範圍 (T.C.&Capacitance Range) pF			本體直徑 Body Diameter (mm)	本體厚度 Body Thickness (mm)	
		Y5P (K, M)	Y5U (M)	Y5V (M, Z)			
CT1	50V	221~102	102~472	102~332	6.5 Max	3.5 Max	
				472~103	7.0 Max	3.5 Max	
	500V	221~102		102~332	6.5 Max	3.5 Max	
		122, 152		472	7.0 Max	3.5 Max	
		222, 332		103	9.0 Max	3.5Max	
CT81	1KV	221~681		102~222	6.5 Max	3.5Max	
		681~102	102~222	222~392	7.5 Max	3.5Max	
		102~182	222~332	392~682	8.5 Max	3.5Max	
		182~222	332~472	682~103	9.5 Max	3.5Max	
	2KV	221~471	102~122	102~152	7.0 Max	4.0Max	
		681~102	122~222	152~332	8.0 Max	4.0Max	
		102~222	272~332	332~472	9.0 Max	4.0Max	
			472	682	10.0 Max	4.0Max	
			103	103	13.0 Max	4.0Max	
	3KV	221~681	102~152	102~222	9.5 Max	5.0Max	
		681~102	182, 222	222~332	10.5 Max	5.0Max	
		102, 152	252, 272	332~472	11.5 Max	5.0Max	
		182, 222	332, 472	682	12.5 Max	5.0Max	
			103	103	13.5 Max	5.0Max	
	4KV	681~102	102, 152	102~222	10.0 Max	6.0Max	
		102, 152	182, 222	222~332	11.0 Max	6.0Max	
			332	332	13.0 Max	6.0Max	
			472	472	15.0 Max	6.0Max	
	6~15KV	101~222 pF根據客戶需求定制 101~222 pF customized according to customer's requirements					

• 容量範圍 Capacitance Range:

產品類型 Product Type	額定電壓 Rated Voltage	溫度特性&容量範圍 (T.C.&Capacitance Range) pF			本體直徑 Body Diameter (mm)	本體厚度 Body Thickness (mm)
		Y5P (K, M)	Y5U (M)	Y5V (M, Z)		
CT7	250VAC	101~471	331, 471	102~152	7.5 Max	5.0Max
		471~561	561, 821	152~222	8.5 Max	5.0Max
		561~681	102~152	222, 332	9.5 Max	5.0Max
		681~821	222, 252	332, 472	10.5 Max	5.0Max
		102~152	332	472	11.5 Max	5.0Max
			472	103	13.5 Max	5.0Max
CT7	400VAC	101, 221	331, 471	102~152	7.0 Max	5.0Max
		331, 471	561, 821	152~222	8.0 Max	5.0Max
		561, 681	102~152	222	9.0 Max	5.0Max
		821	222, 252	332	12.0 Max	5.0Max
		102	332	472	14.0 Max	5.0Max
				103	15.0 Max	5.0Max

產品類型 Product Type	額定電壓 Rated Voltage	溫度特性&容量範圍 (T.C.&Capacitance Range) pF			本體直徑 Body Diameter (mm)	本體厚度 Body Thickness (mm)
		Y5P (K, M)	Y5U (M)	Y5V (M, Z)		
CS1	25V			104	7.0 Max	3.5Max
	50V			104	7.0 Max	3.5Max

X-ON Electronics

Largest Supplier of Electrical and Electronic Components

Click to view similar products for [Ceramic Disc Capacitors](#) category:

Click to view products by [Fenghua Advanced](#) manufacturer:

Other Similar products are found below :

[5AU100JCECA](#) [5AU220JCGCA](#) [5AU560JCJCA](#) [HCU180KBCDRTKR](#) [432202101621](#) [101GHR102K](#) [W1X223MCVCF0KR](#) [CC-100N](#)
[NCD102K1KVY5FF](#) [NCD103M1KVZ5UF](#) [NCD331K1KVY5FF](#) [AOL-1502-02](#) [DEF2CLH040CN3A](#) [F05B1B331KN0B0SHN0](#) [8903D0](#)
[90410-10](#) [YV101103Z060HAND5P](#) [SL102101J060BAND5P](#) [YP202102K080D04A7H](#) [ZU501103M090B20C6P](#) [ZU102103M100X05B0P](#)
[YP102271K050B20C6P](#) [YP102391K050BAND5P](#) [YP501101K040BAND5P](#) [ZU102103M100BAND5H](#) [YP102681K060B20C6P](#)
[YP501121K040B20C6P](#) [SL102181J070HAND5P](#) [YP501471K040B20C6P](#) [SL102151J070HAND5P](#) [YP501102K050HAND5P](#)
[ZU501102M050B20C6P](#) [YP501472K100B20C6P](#) [ZU102103M100B20C0P](#) [YV500223Z080HAND5P](#) [CC1H220KA1EDCH4B1100](#)
[HGK3FE102MG3BW](#) [HGK3FF152MA3BW](#) [HGK3FE472MG3BW-3085A5](#) [HGK3AB271KG2BW](#) [SL500330J040B20C2P](#)
[SL501510J050B20C6P](#) [SL102221J080HAND5P](#) [YP500103M100HAND5P](#) [SL102101J060HAND5H](#) [YP102222K080D20C5B](#)
[LN202471K080D3EAEH](#) [S103Z59Y5VP6TK7R](#) [S222Z33Y5VP6TK5R](#) [S472Z43Y5VP6TK5R](#)