



# 承认书

## APPROVAL SHEET

客户名称:

Customer

/

产品名称:

Part Name

绕线型片式电感器

Wire Wound Chip inductor

产品规格:

Specification

FHW0402UC Series

版本号:

Version No.

21.01

日期:

DATE

2021-4-12

| Manufacturer |            |            | Customer |            |             |
|--------------|------------|------------|----------|------------|-------------|
| 拟制           | 审核         | 确认         | 检验       | 审核         | 批准          |
| Draft by     | Checked by | Approve by | Check by | Checked by | Approval by |
| 林晓华          | 徐雪枫        | 区军沛        |          |            |             |





| 序号<br>No | 目 录<br>TABLE OF CONTENTS                  |
|----------|---|
| 1        | 外形尺寸与内部结构 Dimension & Inner-configuration |
| 2        | 产品品名构成 Product Spec. Model                |
| 3        | 电性能参数表 Electrical Characteristics List    |
| 4        | 可靠性试验项目 Reliability Testing Items         |
| 5        | 产品包装 Packaging                            |
| 6        | 推荐焊接条件 Recommend Soldering Conditions     |
| 7        | 清洗 Cleaning                               |
| 8        | 存储要求 Storage Requirements                 |
| 9        | ODS（消耗臭氧层物质）的使用情况 Usage Of ODS            |
| 10       | 注意事项 Notes                                |



## 1 外形尺寸与内部结构 Dimension & Inner-configuration:

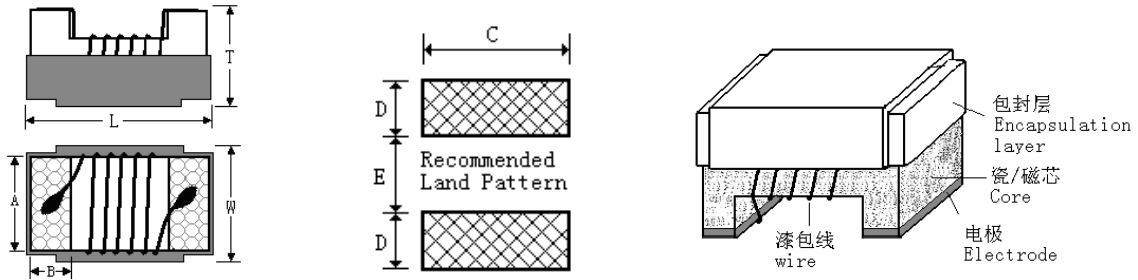

| 序号 No.                | 部位 Component            | 材料 Material  |                 |             |             |             |                       |                    |         |                 |
|-----------------------|-------------------------|--|-----------------|-------------|-------------|-------------|-----------------------|--------------------|---------|-----------------|
| 1                     | 瓷/磁芯 Core               | 陶瓷芯电感 Ceramic Core: 陶瓷体 $Al_2O_3$  |                 |             |             |             |                       |                    |         |                 |
| 2                     | 电极 Electrode            | <table border="1"> <thead> <tr> <th>分类 Type</th> <th>底层 Layout 0</th> <th>中层 Layout 1</th> <th>表层 Layout 2</th> </tr> </thead> <tbody> <tr> <td>陶瓷芯电感<br/>Ceramic core</td> <td>钨或钼锰<br/>W or Mo-Mn</td> <td>镍<br/>Ni</td> <td>金或锡<br/>Au or Sn</td> </tr> </tbody> </table> | 分类 Type         | 底层 Layout 0 | 中层 Layout 1 | 表层 Layout 2 | 陶瓷芯电感<br>Ceramic core | 钨或钼锰<br>W or Mo-Mn | 镍<br>Ni | 金或锡<br>Au or Sn |
|                       |                         | 分类 Type  | 底层 Layout 0     | 中层 Layout 1 | 表层 Layout 2 |             |                       |                    |         |                 |
| 陶瓷芯电感<br>Ceramic core | 钨或钼锰<br>W or Mo-Mn      | 镍<br>Ni  | 金或锡<br>Au or Sn |             |             |             |                       |                    |         |                 |
| 3                     | 漆包线 wire                | 铜 Cu   |                 |             |             |             |                       |                    |         |                 |
| 4                     | 封装层 encapsulation layer | 树脂 UV Adhesive   |                 |             |             |             |                       |                    |         |                 |

单位 Unit: mm (inch)

| 型号 Size    | L (Max)     | W (Max)     | T (Max)     | A           | B           | C           | D           | E           |
|------------|-------------|-------------|-------------|-------------|-------------|-------------|-------------|-------------|
| 1005(0402) | 1.19(0.047) | 0.66(0.026) | 0.60(0.024) | 0.50(0.020) | 0.23(0.009) | 0.66(0.026) | 0.36(0.014) | 0.46(0.018) |
|            |             |             |             |             |             |             |             |             |
|            |             |             |             |             |             |             |             |             |

## 2 产品品名构成 Product Spec. Model

FHW 0402 UC 1N0 K S I  
① ② ③ ④ ⑤ ⑥ ⑦

- ① 绕线型片式电感器系列 Wire Wound Inductor Series;
- ② 外形尺寸 Dimensions: 0402;
- ③ 芯片类型 Material: UC 陶瓷芯 Ceramic core;
- ④ 标称电感量 Inductance: 1N0=1.0nH, 010=10nH, R10=100nH;
- ⑤ 标称电感值偏差 Tolerance: B--- $\pm 0.1nH$ ; C--- $\pm 0.2nH$ ; S--- $\pm 0.3nH$ ; D--- $\pm 0.5nH$ ; G--- $\pm 2\%$ ; H--- $\pm 3\%$ ; J--- $\pm 5\%$ ; K--- $\pm 10\%$ ;
- ⑥ 电极表面镀层材料 Terminal: S---锡端头 Tin;
- ⑦ 包装类型 Packaging type: T 卷带盘装。



### 3 电性能参数表 Electrical Characteristics List

| 型号规格<br>Part NO. | 客户料号<br>Customer P/N | 精度<br>级别<br>accuracy<br>grade | 标称<br>感量<br>Inductance<br>(nH) | 感量测试<br>频率<br>Ls Test<br>frequency<br>(MHz) | Q 值<br>(Min) | Q 值测试<br>频率<br>Test<br>frequency<br>(MHz) | 直流<br>电阻<br>Rdc<br>( $\Omega$ )<br>max | 测试<br>电压<br>Test<br>voltage<br>(mV) | 自谐振<br>频率<br>SRF<br>(MHz) <sub>min</sub> | 额定电流<br>Idc<br>(mA) <sub>max</sub> |
|------------------|----------------------|-------------------------------|--------------------------------|---|--------------|---|--|-------------------------------------|--|------------------------------------|
| FHW0402UC1N0□ST  |                      | B, C, S, D, K                 | 1.0                            | 250   | 13           | 250                                       | 0.045                                  | 500                                 | 10000                                    | 1360                               |
| FHW0402UC1N2□ST  |                      | B, C, S, D, K                 | 1.2                            | 250   | 8            | 250                                       | 0.135                                  | 500                                 | 10000                                    | 640                                |
| FHW0402UC1N8□ST  |                      | C, S, D, K                    | 1.8                            | 250   | 16           | 250                                       | 0.070                                  | 500                                 | 6000                                     | 1040                               |
| FHW0402UC1N9□ST  |                      | C, S, D, K                    | 1.9                            | 250   | 16           | 250                                       | 0.070                                  | 500                                 | 6000                                     | 1040                               |
| FHW0402UC2N0□ST  |                      | C, S, D, K                    | 2.0                            | 250   | 18           | 250                                       | 0.070                                  | 500                                 | 6000                                     | 1040                               |
| FHW0402UC2N2□ST  |                      | C, S, D, K                    | 2.2                            | 250   | 18           | 250                                       | 0.070                                  | 500                                 | 6000                                     | 960                                |
| FHW0402UC2N4□ST  |                      | C, S, D, K                    | 2.4                            | 250   | 16           | 250                                       | 0.080                                  | 500                                 | 6000                                     | 790                                |
| FHW0402UC2N5□ST  |                      | C, S, D, K                    | 2.5                            | 250   | 15           | 250                                       | 0.120                                  | 500                                 | 6000                                     | 640                                |
| FHW0402UC2N7□ST  |                      | C, S, D, K                    | 2.7                            | 250   | 15           | 250                                       | 0.120                                  | 500                                 | 6000                                     | 640                                |
| FHW0402UC2N9□ST  |                      | C, S, D, K                    | 2.9                            | 250   | 8            | 250                                       | 0.300                                  | 500                                 | 6000                                     | 400                                |
| FHW0402UC3N3□ST  |                      | C, S, D, J, K                 | 3.3                            | 250   | 20           | 250                                       | 0.066                                  | 500                                 | 6000                                     | 840                                |
| FHW0402UC3N6□ST  |                      | B, C, S, D, J, K              | 3.6                            | 250   | 20           | 250                                       | 0.066                                  | 500                                 | 6000                                     | 840                                |
| FHW0402UC3N9□ST  |                      | B, C, S, D, J, K              | 3.9                            | 250   | 20           | 250                                       | 0.066                                  | 500                                 | 6000                                     | 840                                |
| FHW0402UC4N3□ST  |                      | C, S, D, J, K                 | 4.3                            | 250   | 20           | 250                                       | 0.091                                  | 500                                 | 6000                                     | 700                                |
| FHW0402UC4N7□ST  |                      | B, C, S, D, J, K              | 4.7                            | 250   | 18           | 250                                       | 0.200                                  | 500                                 | 4500                                     | 640                                |
| FHW0402UC5N1□ST  |                      | B, C, S, D, J, K              | 5.1                            | 250   | 18           | 250                                       | 0.083                                  | 500                                 | 4800                                     | 800                                |
| FHW0402UC5N6□ST  |                      | C, S, D, J, K                 | 5.6                            | 250   | 20           | 250                                       | 0.083                                  | 500                                 | 4800                                     | 760                                |
| FHW0402UC6N2□ST  |                      | C, S, D, J, K                 | 6.2                            | 250   | 23           | 250                                       | 0.083                                  | 500                                 | 4800                                     | 760                                |
| FHW0402UC6N8□ST  |                      | G, H, J, K                    | 6.8                            | 250   | 23           | 250                                       | 0.260                                  | 500                                 | 4800                                     | 680                                |
| FHW0402UC7N5□ST  |                      | G, H, J, K                    | 7.5                            | 250   | 23           | 250                                       | 0.100                                  | 500                                 | 4800                                     | 680                                |
| FHW0402UC8N2□ST  |                      | G, H, J, K                    | 8.2                            | 250   | 25           | 250                                       | 0.100                                  | 500                                 | 4400                                     | 680                                |
| FHW0402UC8N7□ST  |                      | G, H, J, K                    | 8.7                            | 250   | 25           | 250                                       | 0.200                                  | 500                                 | 4100                                     | 480                                |
| FHW0402UC9N0□ST  |                      | G, H, J, K                    | 9.0                            | 250   | 25           | 250                                       | 0.100                                  | 500                                 | 4160                                     | 680                                |
| FHW0402UC9N5□ST  |                      | G, H, J, K                    | 9.5                            | 250   | 25           | 250                                       | 0.200                                  | 500                                 | 4000                                     | 480                                |
| FHW0402UC010□ST  |                      | G, H, J, K                    | 10                             | 250   | 25           | 250                                       | 0.20                                   | 500                                 | 3900                                     | 480                                |
| FHW0402UC011□ST  |                      | G, H, J, K                    | 11                             | 250   | 25           | 250                                       | 0.120                                  | 500                                 | 3680                                     | 640                                |



| 型号规格<br>Part NO. | 客户料号<br>Customer P/N | 精度级别<br>accuracy grade | 标称感量<br>Inductance (nH) | 感量测试频率<br>Ls Test frequency (MHz) | Q 值 (Min) | Q 值测试频率<br>Test frequency (MHz) | 直流电阻<br>Rdc (Ω) max | 测试电压<br>Test voltage (mV) | 自谐振频率<br>SRF (MHz)min | 额定电流<br>Idc (mA)max |
|------------------|----------------------|------------------------|-------------------------|-----------------------------------|-----------|---------------------------------|---------------------|---------------------------|-----------------------|---------------------|
| FHW0402UC012□ST  |                      | J, K                   | 12                      | 250                               | 25        | 250                             | 0.120               | 500                       | 3600                  | 640                 |
| FHW0402UC013□ST  |                      | G, H, J, K             | 13                      | 250                               | 25        | 250                             | 0.210               | 500                       | 3450                  | 440                 |
| FHW0402UC015□ST  |                      | G, H, J, K             | 15                      | 250                               | 25        | 250                             | 0.300               | 500                       | 3280                  | 560                 |
| FHW0402UC016□ST  |                      | G, H, J, K             | 16                      | 250                               | 25        | 250                             | 0.220               | 500                       | 3100                  | 560                 |
| FHW0402UC018□ST  |                      | G, H, J, K             | 18                      | 250                               | 25        | 250                             | 0.230               | 500                       | 3100                  | 420                 |
| FHW0402UC019□ST  |                      | G, H, J, K             | 19                      | 250                               | 25        | 250                             | 0.200               | 500                       | 3040                  | 480                 |
| FHW0402UC020□ST  |                      | G, H, J, K             | 20                      | 250                               | 25        | 250                             | 0.250               | 500                       | 3000                  | 420                 |
| FHW0402UC022□ST  |                      | G, H, J, K             | 22                      | 250                               | 25        | 250                             | 0.300               | 500                       | 2800                  | 400                 |
| FHW0402UC023□ST  |                      | G, H, J, K             | 23                      | 250                               | 22        | 250                             | 0.380               | 500                       | 2720                  | 310                 |
| FHW0402UC024□ST  |                      | G, H, J, K             | 24                      | 250                               | 25        | 250                             | 0.300               | 500                       | 2700                  | 400                 |
| FHW0402UC027□ST  |                      | G, H, J, K             | 27                      | 250                               | 24        | 250                             | 0.520               | 500                       | 2480                  | 280                 |
| FHW0402UC030□ST  |                      | G, H, J, K             | 30                      | 250                               | 25        | 250                             | 0.500               | 500                       | 2350                  | 400                 |
| FHW0402UC033□ST  |                      | G, H, J, K             | 33                      | 250                               | 24        | 250                             | 0.650               | 500                       | 2350                  | 350                 |
| FHW0402UC036□ST  |                      | G, H, J, K             | 36                      | 250                               | 25        | 250                             | 0.600               | 500                       | 2320                  | 250                 |
| FHW0402UC039□ST  |                      | G, H, J, K             | 39                      | 250                               | 25        | 250                             | 0.750               | 500                       | 2100                  | 200                 |
| FHW0402UC040□ST  |                      | G, H, J, K             | 40                      | 250                               | 25        | 250                             | 0.600               | 500                       | 2240                  | 220                 |
| FHW0402UC043□ST  |                      | J, K                   | 43                      | 250                               | 25        | 250                             | 0.810               | 500                       | 2030                  | 100                 |
| FHW0402UC047□ST  |                      | G, H, J, K             | 47                      | 250                               | 25        | 250                             | 0.830               | 500                       | 2100                  | 150                 |
| FHW0402UC051□ST  |                      | J, K                   | 51                      | 250                               | 25        | 250                             | 0.820               | 500                       | 1750                  | 100                 |
| FHW0402UC056□ST  |                      | G, H, J, K             | 56                      | 250                               | 25        | 250                             | 0.97                | 500                       | 1760                  | 100                 |
| FHW0402UC062□ST  |                      | G, H, J, K             | 62                      | 250                               | 25        | 250                             | 1.120               | 500                       | 1620                  | 100                 |
| FHW0402UC068□ST  |                      | G, H, J, K             | 68                      | 250                               | 25        | 250                             | 1.12                | 500                       | 1620                  | 100                 |
| FHW0402UC075□ST  |                      | G, H, J, K             | 75                      | 250                               | 25        | 250                             | 1.630               | 500                       | 1400                  | 50                  |
| FHW0402UC082□ST  |                      | G, H, J, K             | 82                      | 250                               | 25        | 250                             | 1.70                | 500                       | 1260                  | 50                  |
| FHW0402UCR10□ST  |                      | G, H, J, K             | 100                     | 250                               | 25        | 250                             | 2.00                | 500                       | 1160                  | 30                  |
| FHW0402UCR12□ST  |                      | G, H, J, K             | 120                     | 250                               | 25        | 250                             | 2.20                | 500                       | 1100                  | 30                  |

□表示标称感量精度级别 represents the nominal sensitivity accuracy level: B (±0.1); C (±0.2); S (±0.3); D (±0.5); G (±2%); H (±3%); J (±5%); K (±10%)。



#### 4 可靠性试验项目 Reliability Testing Items

| 序号<br>No. | 项目<br>Items                           | 要求<br>Requirements   | 试验方法及备注<br>Test Methods and Remarks   |
|-----------|---------------------------------------|--|---|
| 1         | 试验用标准条件<br>Test Standard Conditions   | ①、除非另有规定，所有试验和测量在下述条件进行。Unless otherwise specified, all tests and measurements shall be carried out in the following conditions.<br>a) 温度 Temperature: 15℃~+35℃;<br>b) 相对湿度 Relative humidity: 25%~75%;<br>c) 气压 pressure: 86 kPa~106 kPa.<br>②、在上述条件下测定有异议发生场合，按下述条件进行。Under the above conditions, the conditions for the determination of dissension shall be conducted according to the following conditions.<br>a) 温度 Temperature: 20℃±1℃;<br>b) 相对湿度 Relative humidity: 63%~67%;<br>c) 气压 pressure: 86 kPa~106 kPa. |   |
| 2         | 工作温度范围<br>Operating Temperature Range | FHW-UC series: -40℃~+125℃  | /   |
| 3         | 可焊性<br>Solder ability                 | ①外观无可见损伤痕迹;<br>No visible mechanical damage.<br>②端电极表面焊锡覆盖率。<br>Electrode surface solder coverage.<br>FHW-UC series: ≥90%;   | 在 245±5℃熔融的焊锡 (96.5%Sn/3.0%Ag/0.5%Cu) 中浸置 5±1s。<br>Dip pads in flux and dip in solder pot(96.5Sn/3.0Ag/0.5Cu)at 245±5℃ for 5±1s.  |
| 4         | 耐焊接热<br>Resistance to Soldering       | ①外观无可见损伤痕迹;<br>No visible mechanical damage.<br>②感量变化不超过±5%;<br>Inductance shall not change more than ±5%;<br>③Q 值变化不超过±10%。<br>Q shall not change more than±10%.  | 在 260±5℃熔融的焊锡 (96.5%Sn/3.0%Ag/0.5%Cu) 中浸置 10±1s。<br>Dip pads in flux and dip in solder pot(96.5Sn/3.0Ag/0.5Cu)at 260±5℃ for 10±1s.  |
| 5         | 振动<br>Vibration                       | ①外观无可见损伤痕迹;<br>No visible mechanical damage.<br>②感量变化不超过±5%;<br>Inductance shall not change more than ±5%;<br>③Q 值变化不超过±10%。<br>Q shall not change more than±10%.  | 振幅 1.5mm, 频率 10~55Hz, 每个方向(X、Y、Z)保持 2 小时。Inductors shall be subjected to vibration of 1.5mm amplitude frequency 10~55Hz (10Hz to 55Hz to 10Hz in a period of 1 minute) for 2h in each of three(X、Y、Z) axes. |

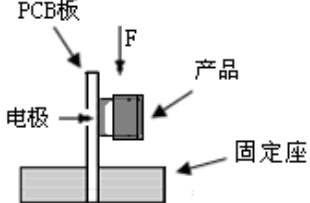

| 序号<br>No.          | 项目<br>Items                        | 要求<br>Requirements  | 试验方法及备注<br>Test Methods and Remarks  |           |       |               |    |                    |  |                  |  |
|--------------------|------------------------------------|---|--|-----------|-------|---------------|----|--------------------|--|------------------|--|
| 6                  | 端电极强度<br>Adhesion of electrode     | ①试验后端电极无脱落;<br>The end electrode did not fall off after the test.<br>②外观无可见损伤痕迹。<br>No visible mechanical damage.   | 将产品焊在 PCB 板上, 按下图、表所示方向及要求施加作用力。Weld the product on the PCB board, and apply force as shown in the diagram, direction and requirement.<br> <table border="1" data-bbox="997 750 1452 963"> <tr> <td>尺寸规格 Size</td> <td>施加力要求</td> </tr> <tr> <td>0402UC Series</td> <td>5N</td> </tr> <tr> <td colspan="2">Keep time: (10±1)s</td> </tr> <tr> <td colspan="2">Speed: 1.0 mm/s.</td> </tr> </table> | 尺寸规格 Size | 施加力要求 | 0402UC Series | 5N | Keep time: (10±1)s |  | Speed: 1.0 mm/s. |  |
| 尺寸规格 Size          | 施加力要求                              |   |  |           |       |               |    |                    |  |                  |  |
| 0402UC Series      | 5N                                 |   |  |           |       |               |    |                    |  |                  |  |
| Keep time: (10±1)s |                                    |   |  |           |       |               |    |                    |  |                  |  |
| Speed: 1.0 mm/s.   |                                    |   |  |           |       |               |    |                    |  |                  |  |
| 7                  | 耐低温<br>Low temperature resistance  | ①外观无可见损伤痕迹;<br>No visible mechanical damage.<br>②感量变化不超过±5%;<br>Inductance shall not change more than ±5%;<br>③Q 值变化不超过±10%。<br>Q shall not change more than±10%. | FHW-UC 系列产品放置于温度-40±2℃的环境中存放 1000 <sup>+24</sup> -0 h<br>FHW-UC series shall be subjected to-40±2℃ <sup>+24</sup> for 1000 <sup>+24</sup> -0 h   |           |       |               |    |                    |  |                  |  |
| 8                  | 耐高温<br>High temperature resistance | ①外观无可见损伤痕迹;<br>No visible mechanical damage.<br>②感量变化不超过±5%;<br>Inductance shall not change more than ±5%;<br>③Q 值变化不超过±10%。<br>Q shall not change more than±10%. | FHW-UC 系列产品放置于温度+125±5℃的环境中存放 1000 <sup>+24</sup> -0 h<br>FHW-UC series shall be subjected to <sup>+24</sup> +125±5℃ for 1000 <sup>+24</sup> -0 h  |           |       |               |    |                    |  |                  |  |
| 9                  | 温度冲击<br>Temperature Shock          | ①外观无可见损伤痕迹;<br>No visible mechanical damage.<br>②感量变化不超过±5%;<br>Inductance shall not change more than ±5%;<br>③Q 值变化不超过±10%。<br>Q shall not change more than±10%. | FHW-UC 系列: +125℃ 30 分钟 ↔ -40℃ 30 分钟, 循环 100 次;<br>FHW-UC series : +125℃ 30minutes ↔ -40℃ 30minutes 100 Cycles.   |           |       |               |    |                    |  |                  |  |





| 序号<br>No. | 项目<br>Items                   | 要求<br>Requirements  | 试验方法及备注<br>Test Methods and Remarks  |
|-----------|-------------------------------|---|--|
| 10        | 高温负载<br>High temperature load | ①外观无可见损伤痕迹;<br>No visible mechanical damage.<br>②感量变化不超过±5%;<br>Inductance shall not change more than ±5%;<br>③Q 值变化不超过±10%.<br>Q shall not change more than±10%. | FHW-UC 系列产品加额定电流在 125±2℃温度条件下存放 1000—0 h<br>FHW-UC series shall be store at 125±2℃ for 1000—0 h with rated current applied.  |
| 11        | 恒定湿热<br>Static Humidity       | ①外观无可见损伤痕迹;<br>No visible mechanical damage.<br>②感量变化不超过±5%;<br>Inductance shall not change more than ±5%;<br>③Q 值变化不超过±10%.<br>Q shall not change more than±10%. | 将电感器放置在于湿度 90%~95%,温度 60±2℃的环境中存放 1000—0 h<br>Inductors shall be subjected to 90%~95%RH. at 60±2℃ for 1000—0 h   |
| 12        | 抗弯强度<br>Bending strength      | 外观无可见损伤痕迹;<br>No visible mechanical damage.   | ①将电感器安装于试验基板上; 在垂直方向施加力(如下图所示)。Install the inductor on the test substrate; Apply force in the vertical direction (as shown below).<br>②该板应在 (1±0.5) mm/s 的弯曲速率向下弯曲 (2±0.2) mm, 保持时间 (20±1) s。The epoxy plate should bend down to (2±0.2) mm at the bending rate of (1±0.5) mm/s, Keep time (20±1) sec. |

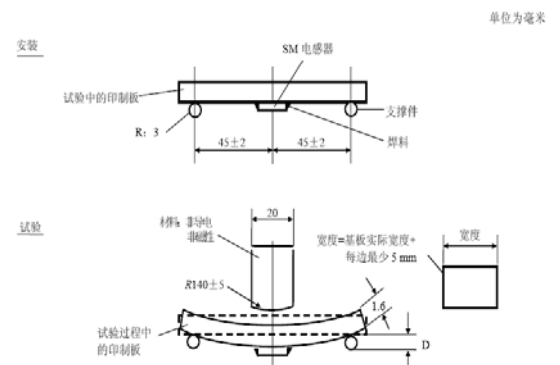



| 序号<br>No.   | 项目<br>Items                   | 要求<br>Requirements  | 试验方法及备注<br>Test Methods and Remarks  |
|---|-------------------------------|---|--|
| 13  | 耐溶剂性<br>Solvent<br>Resistance | ①外观无可见损伤痕迹;<br>No visible mechanical damage.<br>②感量变化不超过±5%;<br>Inductance shall not change more than ±5%;<br>③Q 值变化不超过±10%.<br>Q shall not change more than±10%. | 将元件浸泡在 23±5℃ 的异丙醇溶液中, 保持 5±0.5 分钟。<br>Soak in the element 23±5℃ in isopropyl alcohol solution, keep 5±0.5 min. |
| 注: 以上要求测试电性能的项目, 在室温下放置至少 2 h 后在 48 h 内进行测试。<br>Note: When there are questions concerning, test within 48 h after placing at room temperature for at least 2 h. |                               |   |  |

## 5 产品包装 Packaging

### 1) 编带图 Taping drawings

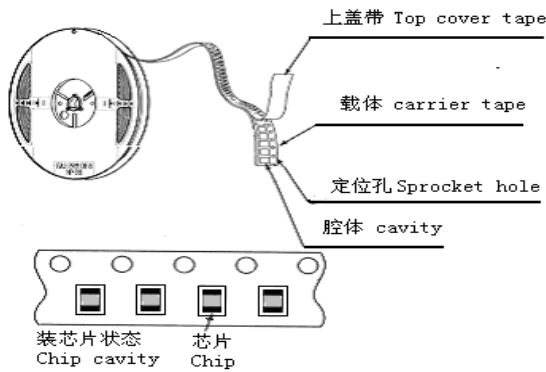

### 2) 卷盘尺寸 Reel dimensions (Unit: mm)

| Part NO. | ΦA<br>typ. | ΦB<br>typ. | ΦC<br>typ. | D typ. |
|----------|------------|------------|------------|--------|
| 0402     | 178        | 60         | 13         | 8.4    |
|          |            |            |            |        |

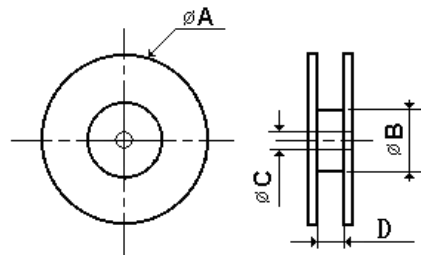

### 3) 导带及空格部分 Leader and blank portion

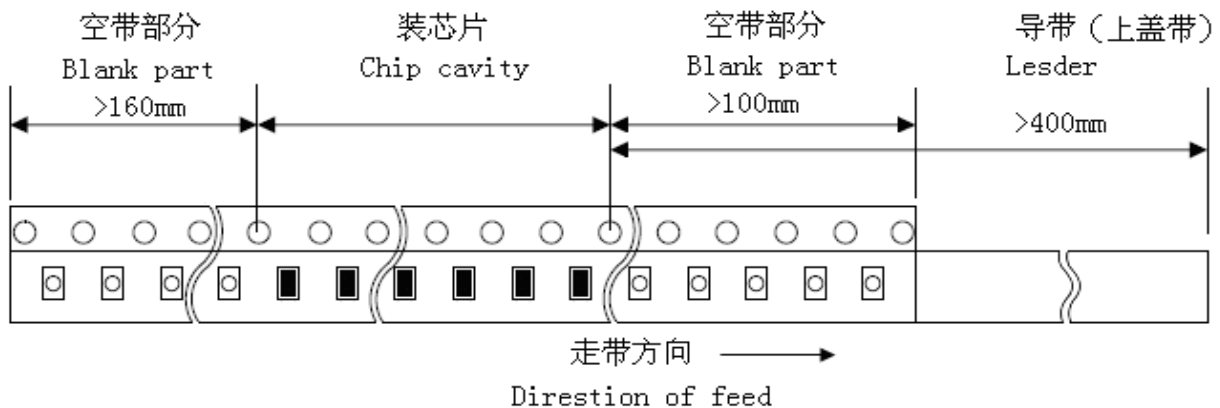



4) 编带尺寸 Taping dimensions (Unit: mm)

- 纸带 Paper tape

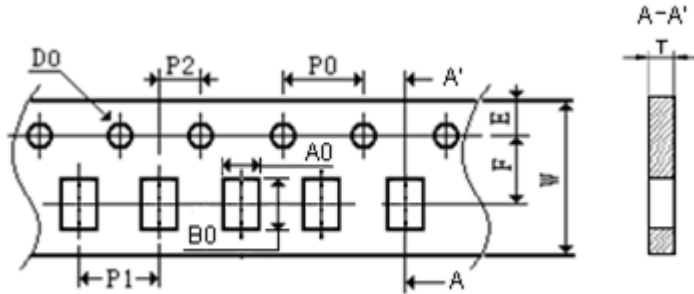

| Part NO. | W    | E    | F    | D0   | P0 | P1 | P2 | P0×10 | A0   | B0   | T    |
|----------|------|------|------|------|----|----|----|-------|------|------|------|
| 0402     | 8.00 | 1.75 | 3.50 | 1.55 | 4  | 2  | 2  | 40    | 0.74 | 1.23 | 0.68 |
|          |      |      |      |      |    |    |    |       |      |      |      |

5) 剥离力检验 Peeling off force

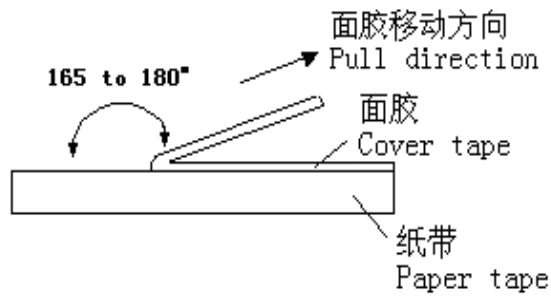

① 盖带的剥离力要求 Peeling required

0402 系列 series: 20g~80g

② 测试条件 Test condition

盖带剥离速度: 300mm/min±10%

Speed of peeling off : 300mm/min±10%

盖带剥离角度: 165° ~180°

Angle of peeling off: 165°~180°

6) 包装数量 (单位: 粒) Packaging number (Unit: Pcs )

|                  |        |        |
|------------------|--------|--------|
| 类型 Size          |        | 0402   |
| 每卷数量 Per Reel    |        | 5000   |
| 每盒数量<br>Per Box  | 3 卷盒   | 15000  |
|                  | 5 卷盒   | 25000  |
| 每箱数量<br>Per Case | 1.5 盒箱 | 75000  |
|                  | 2 盒箱   | 100000 |
|                  | 3 盒箱   | 150000 |
|                  | 4 盒箱   | 200000 |
|                  | 6 盒箱   | 300000 |



### 7) 标签粘贴位置 Label stick station

| 卷盘标签 Reel label   | 纸盒标签 Carton label   | 纸盒标签 Carton label   | 外箱标签 Outer box label  |
|---|---|---|---|
|  |  |  |  |

## 6 推荐焊接条件 Recommend Soldering Conditions

### 1) 焊接条件 Soldering Conditions

本产品使用回流焊接法。

Reflow soldering is applied to this product.

#### ① 焊剂要求 Flux, Solder

- 使用松香基助焊剂，禁止使用卤化物含量超过 0.2(wt)%的强酸性助焊剂。  
Don't use highly acidic flux with halide content exceeding 0.2(wt)%(chlorine conversion value).
- 使用无铅焊料 (96.5Sn /3.0Ag/0.5Cu)。  
Using lead-free solder (96.5Sn /3.0Ag/0.5Cu)。

#### ② 焊接要求 Soldering conditions

- 预热时，产品表温与焊料温度的温差最大不允许超出 150℃，焊接完冷却时，产品表温与溶剂温度之间的温差最大不超过 100℃。预热不足有可能引发产品表面裂纹，从而导致产品品质下降。  
Pre-heating should be in such a way that the temperature difference between solder and ferrite surface is limited to 150℃ max. Also cooling into solvent after soldering should be in such way that the temperature difference is limited to 100℃ max. Un-enough pre-heating may cause cracks on the ferrite, resulting in the deterioration of product quality.
- 产品要在以下画出的曲线允许的范围进行焊接。其它焊接条件可能引起产品电极的腐蚀。当焊接重复时，允许的时间为第一次做的累计时间。  
Products should be soldered within the following allowable range indicated by the slanted line. The excessive soldering conditions may cause the corrosion of the electrode. When soldering is repeated, allowable time is the accumulated time.

### 2) 回流焊曲线 Reflow soldering profile

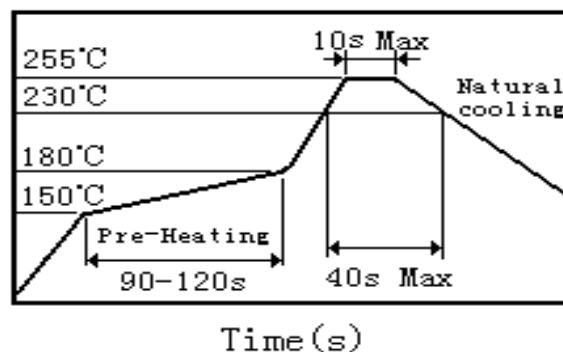



### 3) 手工焊接 Iron soldering

烙铁温度：350℃ (Max)

功率：最大为 30W

烙铁停留时间：<5S (注意不要将烙铁碰到产品线圈及包封层)。

Perform soldering at 350℃ on 30W max.

Soldering Time: < 5S (Take care not to apply the tip of the soldering iron to the terminal electrodes)。

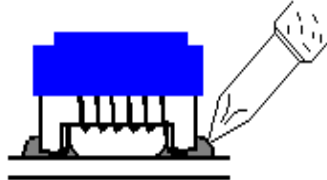

## 7 清洗 Cleaning

### 1) 清洗条件 Cleaning Conditions

- |                      |                                    |
|----------------------|------------------------------------|
| a. 清洗温度 : 60℃ (Max)  | Cleaning temperature : 60℃ max.    |
| b. 清洗时间 : 5 分钟 (Max) | Cleaning time: 5 minutes Max.      |
| c. 超声波功率: 最大为 200W   | Ultrasonic output power: 200W max. |

## 8 存储要求 Storage Requirements

### 1) 存储期限 Storage period

距电感公司出厂检验时间 1 年内，产品可以使用检验时间可以通过包装外侧标记的检验号确认。若时间超过 1 年，应检查焊接性能后方可使用。

Products which inspected inductor company over 1 year ago should be examined and used, which can be Confirmed with inspection No. marked on the container. Solder ability should be checked if this period is exceeded.

- (1) 存放货物的库房应满足以下条件：温度：-10 ~ +40℃，相对湿度：30 ~ 70%。
- (2) 禁止将产品保管在腐蚀性物质中，如硫磺、氯气或酸，否则将引起端头氧化，导致降低焊接性。
- (3) 为了避免受潮气、灰尘等物质的影响，产品应保管于货架上。
- (4) 产品保管在库房中，应避免热冲击、振动以及直接光照等等。
- (5) 产品应密封包装。

(1) Products should be storage in the warehouse on the following conditions:

Temperature : -10~+40℃ Humidity: 30~70% relative humidity

- (2) Don't keep products in corrosive gases such as sulfur, chlorine gas or acid , or it may case oxidization of Electrodes resulting in poor solder ability.
- (3) Products should be stored on the palette for the prevention of the influence from humidity, dust and so on.
- (4) Products should be stored in the warehouse without heat shock, vibration, direct sunlight and so on.
- (5) Products should be stored under the airtight packaged condition.



## 9 ODS（消耗臭氧层物质）的使用情况 Usage Of ODS

对于以下所列物质，我公司在生产过程中绝不使用。

ODS: CCl<sub>4</sub>（四氯化碳）、HCFC 等。

For ODS listed below , we don't use in process.

ODS: CCl<sub>4</sub>, HCFC, etc.

## 10 注意事项 Notes

### (1) RoHS 指令 Response to RoHS directive

本公司产品符合 RoHS 指令。

Our products are RoHS compliance.

(2) 本承认书保证我司产品作为一个单体时的质量情况，当我司产品被安装到贵公司产品上时请保证贵司的产品已根据贵司的规范进行了有效评价和确认。

This product specification guarantees the quality of our product as a single unit, Please make sure that your product has been evaluated and confirmed against your specifications when our product is mounted to your product.

(3) 如果贵司对我司产品的试用已超过了本测试规范所界定的产品功能，对于此所引发的失效我司将不予保证。

We can't warrant against failure caused by any use of our product that deviates from the intended use as described in this product specification.

(4) 为防止断线，请不要使用锋利的物体接触线圈，如镊子。

Do not touch wire with sharp objects such as tweezers to prevent wire breakage.

## X-ON Electronics

Largest Supplier of Electrical and Electronic Components

*Click to view similar products for [Fixed Inductors](#) category:*

*Click to view products by [Fenghua Advanced](#) manufacturer:*

Other Similar products are found below :

[CR32NP-151KC](#) [CR32NP-180KC](#) [CR32NP-181KC](#) [CR32NP-1R5MC](#) [CR32NP-390KC](#) [CR32NP-3R9MC](#) [CR32NP-680KC](#) [CR32NP-820KC](#) [CR32NP-8R2MC](#) [CR43NP-390KC](#) [CR43NP-560KC](#) [CR43NP-680KC](#) [CR54NP-181KC](#) [CR54NP-470LC](#) [CR54NP-820KC](#) [CR54NP-8R5MC](#) [70F224AI](#) [MGDQ4-00004-P](#) [MHL1ECTTP18NJ](#) [MHQ1005P10NJ](#) [MHQ1005P1N0S](#) [MHQ1005P2N4S](#) [MHQ1005P3N6S](#) [MHQ1005P5N1S](#) [MHQ1005P8N2J](#) [PE-51506NL](#) [PE-53601NL](#) [PE-53602NL](#) [PE-53630NL](#) [PE-53824SNLT](#) [PE-92100NL](#) [PG0434.801NLT](#) [PG0936.113NLT](#) [9220-20](#) [9310-16](#) [PM06-2N7](#) [PM06-39NJ](#) [A01TK](#) [1206CS-471XJ](#) [HC2LP-R47-R](#) [HC2-R47-R](#) [HC3-2R2-R](#) [HCF1305-3R3-R](#) [1206CS-151XG](#) [RCH664NP-140L](#) [RCH664NP-4R7M](#) [RCH8011NP-221L](#) [RCP1317NP-332L](#) [RCP1317NP-391L](#) [RCR1010NP-470M](#)