



# 承认书

## APPROVAL SHEET

客户名称:

Customer

产品名称:

功率电感器

Part Name

Power Inductor

客户料号:

Customer P/N

物料描述:

Material description

产品规格:

MS73 Series

Specification

版本号:

22.01

Version No.

日期:

2022-1-28

DATE

制造 Manufacturer			客户 Customer		
拟制 Draft by	审核 Checked by	确认 Approve by	检验 Check by	审核 Checked by	批准 Approval by
唐程华	冯东梅	冯东梅			





履历表  
Resume

版本 Ver. No.	修改明细 Modify Details	修改 Reviser	日期 Date
22.01	首次发行 Initial issue	唐程华	2022-1-28



## 目 录 TABLE OF CONTENTS

---

- 1 适用范围 Scope
- 2 型号表示办法 How To Order
- 3 尺寸与结构 External Dimensions and Structural Diagram
- 4 测试条件 Testing conditions.
- 5 工作温度范围 Operating Temperature Range
- 6 电气性能 Performance Specification
- 7 可靠性 Reliability Data
- 8 包装 Package
- 9 环保情况说明 Environmental Protection Statement
- 10 推荐使用的焊接曲线 Recommended soldering profile
- 11 清洗 Cleaning
- 12 贮存方法 Storage Methods
- 13 使用注意事项 Precautions For Use



## 1. 适用范围 Scope.

本规格书适用于 MS73 系列贴片功率电感器。

This specification applies to the MS73 series of SMD power inductors.

## 2. 型号表示办法 How To Order.

MS   73   -   6R8   □   T   □□□

①

②

③

④

⑤

⑥

①产品代号, Product symbol.

②尺寸代码, Dimension code, 长度与厚度, Length and thickness.

③电感量标称值, Inductance, 1R0→1.0μH, 100→10μH, 101→100μH.

④电感量公差代码, Inductance Tolerance code, N ±30%, M ±20%.

⑤包装代码, T-编带卷盘; Packing code: T-Tape & reel.

⑥内部代码, Internal code.

## 3. 尺寸与结构 External Dimensions and Structural Diagram.

单位 Unit: mm

### 3.1. 尺寸 External Dimensions

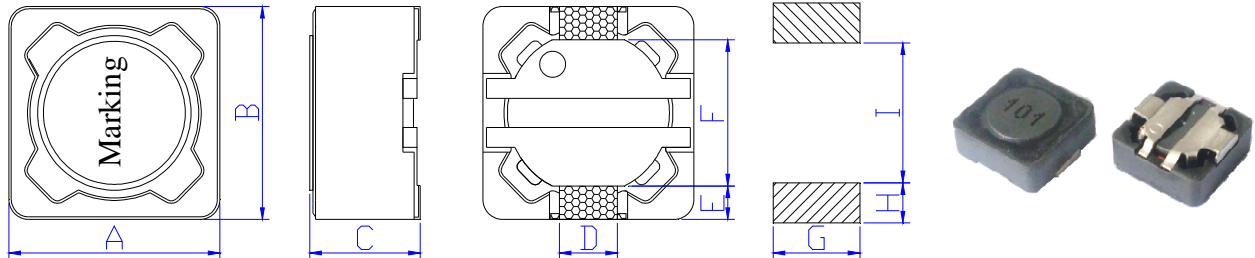

RECOMMENDED  
LAND PATTERNS

顶部印字 Marking: 1.0μH→1R0, 10μH→100, 100μH→101, 1000μH→102

A	B	C	D Typical	E Typical	F Typical	G Typical	H Typical	I Typical
7.3±0.30	7.3±0.30	3.4±0.30	2.0	1.1	5.0	2.2	1.6	4.8



### 3.2. 结构图 Structural drawing:

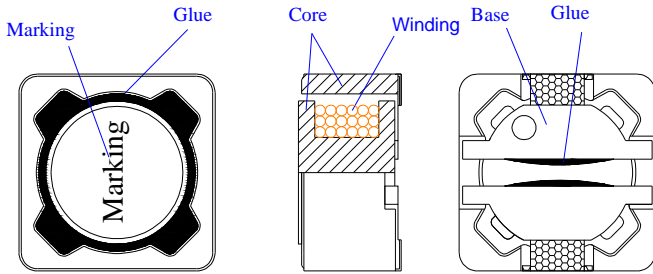

No.	部位 Component	材料 Material
①	磁芯 Core	镍锌铁氧体 DR/RI 磁芯 Ni-Zn ferrite DR/RI core
②	线圈 Winding	漆包线 Enamelled Wire H class
③	电极片 Base	Phosphor bronze
④	粘结剂 Glue	环氧树脂 Epoxy
⑤	印字 Marking	油墨 INK

## 4. 测试条件 Testing conditions.

4.1. 除非另有规定，否则在以下条件下测试. Unless otherwise specified

温度：常温 Temperature : Ordinary Temperature	20±15 °C
湿度：常湿 Humidity: Ordinary Humidity	65±20 % RH

4.2. 当对测量结果有疑问时 In case of doubt

温度 Temperature	20±2 °C
湿度 Humidity	65±5 % RH
大气压 Atmospheric Pressure	86 to 106 kPa

4.3. 测试示意图 Test schematic diagram.

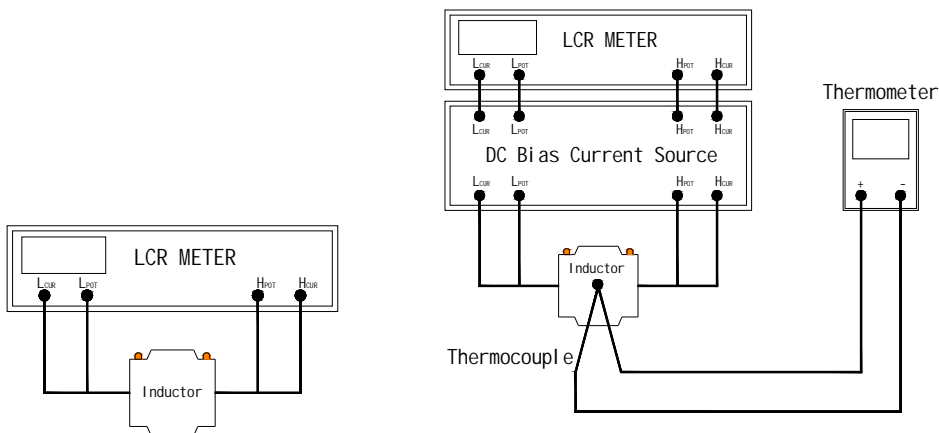

Ls & RDC test schematic diagram

Isat & Irms test schematic diagram

## 5. 工作温度范围 Operating Temperature Range

-40 °C ~ +85 °C, 包括自身发热。Including self-heating



## 6. 电气性能 Performance Specification

### 6.1. 电气特性 Electrical characteristics

客户料号 Customers Part No.	风华型号 Fenghua Part No.	电感量 Inductance		直流电阻 Direct Current Resistance		额定电流 Rated DC Current IDC (A)	印字 Marking
		Ls ( $\mu$ H)		RDC ( $\Omega$ )			
	MS73-R70NT	0.70	$\pm 30\%$	0.012	Max	5.50	R70
	MS73-R90NT	0.90	$\pm 30\%$	0.016	Max	4.00	R90
	MS73-1R0NT	1.00	$\pm 30\%$	0.025	Max	3.60	1R0
	MS73-1R5NT	1.50	$\pm 30\%$	0.028	Max	3.00	1R5
	MS73-1R8NT	1.80	$\pm 30\%$	0.030	Max	2.75	1R8
	MS73-2R2NT	2.20	$\pm 30\%$	0.035	Max	2.50	2R2
	MS73-3R3NT	3.30	$\pm 30\%$	0.038	Max	2.00	3R3
	MS73-4R7NT	4.70	$\pm 30\%$	0.040	Max	1.82	4R7
	MS73-5R6NT	5.60	$\pm 30\%$	0.057	Max	1.82	5R6
	MS73-6R8NT	6.80	$\pm 30\%$	0.058	Max	1.70	6R8
	MS73-100MT	10	$\pm 20\%$	0.072	Max	1.68	100
	MS73-120MT	12	$\pm 20\%$	0.098	Max	1.52	120
	MS73-150MT	15	$\pm 20\%$	0.130	Max	1.33	150
	MS73-180MT	18	$\pm 20\%$	0.140	Max	1.20	180
	MS73-220MT	22	$\pm 20\%$	0.190	Max	1.07	220
	MS73-330MT	33	$\pm 20\%$	0.240	Max	0.91	330
	MS73-390MT	39	$\pm 20\%$	0.320	Max	0.77	390
	MS73-470MT	47	$\pm 20\%$	0.360	Max	0.76	470
	MS73-560MT	56	$\pm 20\%$	0.470	Max	0.68	560
	MS73-680MT	68	$\pm 20\%$	0.520	Max	0.61	680
	MS73-820MT	82	$\pm 20\%$	0.690	Max	0.57	820
	MS73-101MT	100	$\pm 20\%$	0.790	Max	0.50	101
	MS73-121MT	120	$\pm 20\%$	0.890	Max	0.49	121
	MS73-151MT	150	$\pm 20\%$	1.270	Max	0.43	151
	MS73-181MT	180	$\pm 20\%$	1.450	Max	0.39	181
	MS73-221MT	220	$\pm 20\%$	1.650	Max	0.35	221
	MS73-271MT	270	$\pm 20\%$	2.310	Max	0.32	271
	MS73-331MT	330	$\pm 20\%$	2.620	Max	0.28	331
	MS73-391MT	390	$\pm 20\%$	2.940	Max	0.26	391
	MS73-471MT	470	$\pm 20\%$	4.180	Max	0.24	471
	MS73-561MT	560	$\pm 20\%$	4.670	Max	0.22	561
	MS73-681MT	680	$\pm 20\%$	5.730	Max	0.19	681
	MS73-821MT	820	$\pm 20\%$	6.540	Max	0.18	821
	MS73-102MT	1000	$\pm 20\%$	9.440	Max	0.16	102



IDC: 指使电感量比初始值下降 20%或电感器表面温度上升 40℃的电流值 (参考周围环境温度 20℃)。

The rated DC current is that which cause a 20% inductance reduction from the initial value or inductor surface temperature to rise by 40℃, whichever is smaller. ( Reference ambient temperature 20℃).

## 6.2. 测试条件与仪器 Test condition & equipment:

项目 Item	测试条件 Test condition	测试仪器 Test equipment
电感量 Ls	1kHz/500mV	HP4263B\IM3532-50 or equivalent
直流电阻 RDC	直流电 direct-current	HP4263B\RM3545 or equivalent
额定电流 IDC	1kHz/500mV	Microtest 6379 & 6220 or equivalent



## 7. 可靠性 Reliability Data

序号 No.	项目 Items	要求 Requirements	试验方法及备注 Test Methods and Remarks
7.1	绝缘电阻 Insulation Resistance	$\geq 100M\Omega$	在电感器线圈和磁芯之间施加 100 V 直流电压保持 60s。 100 V DC between inductor coil and core for 60 seconds.
7.2	可焊性 Solderability	电极面 95%以上覆盖新的焊料。 95% or more of electrode area shall be coated by new solder.	在 245 °C $\pm$ 5 °C 熔融的焊锡 (96.5Sn/3.0Ag/0.5Cu) 中浸 5 s $\pm$ 1 s。 Dip pads in flux and dip in solder pot (96.5Sn/3.0Ag/0.5Cu) at 245 °C $\pm$ 5 °C for (5 $\pm$ 1) seconds.
7.3	耐焊接热 Resistance to Soldering Heat	外观无可见机械损伤; 电感量变化率: $\pm 10\%$ 以内。 No visible mechanical damage. Inductance change: Within $\pm 10\%$	在 260 °C $\pm$ 5 °C 熔融的焊锡 (96.5Sn/3.0Ag/0.5Cu) 中浸 10 s $\pm$ 1 s。 Dip pads in flux and dip in solder pot (96.5Sn/3.0Ag/0.5Cu) at 260°C $\pm$ 5 °C for (10 $\pm$ 1) seconds.
7.4	端子强度 Adhesion of terminal electrode	元件的端子与本体结合无松动、无 脱落。 Strong bond between the pad and the core, without come off PC board.	将电感器用 260 °C $\pm$ 5 °C, 20 s $\pm$ 5 s 焊在 带有 0.3 mm 厚锡膏的基板上, 然后用冶 具垂直电极面方向加压 10 N, 10 s $\pm$ 1 s。 Inductors shall be subjected to 260 °C $\pm$ 5 °C for 20 s $\pm$ 5 s Soldering in the base whit 0.3mm solder. And then aplomb electrode way plus tax 10 N for 10 $\pm$ 1s seconds.
7.5	耐高温 High temperature	外观无可见机械损伤; 电感量变化率: $\pm 10\%$ 以内。 No visible mechanical damage. Inductance change: Within $\pm 10\%$	温度+85 °C $\pm$ 2 °C, 时间 1000 <sup>+24</sup> h, 在室 温下放置 2 小时后、48 小时内测试。 Temperature 85 °C $\pm$ 2 °C, time 1000 <sup>+24</sup> h, Test within 48 hours after 2 hours of placement at room temperature
7.6	耐低温 Low temperature	外观无可见机械损伤; 电感量变化率: $\pm 10\%$ 以内。 No visible mechanical damage. Inductance change: Within $\pm 10\%$	温度-40 °C $\pm$ 2 °C, 时间 1000 <sup>+24</sup> h; 在室 温下放置 2 小时后、48 小时内测试。 Temperature -40 °C $\pm$ 2 °C, time 1000 <sup>+24</sup> h; Test within 48 hours after 2 hours of placement at room temperature





(续上表 Continue on the table)

序号 No.	项目 Items	要求 Requirements	试验方法及备注 Test Methods and Remarks
7.7	温度循环 Temperature Cycling	外观无可见机械损伤； 电感量变化率：±10%以内。 No visible mechanical damage. Inductance change: Within ±10%	(-40±3) °C,时间(30±3) min ↔ (85±2) °C/(30±3) min, 转换时间(2~3) min,循 环 32 次；在室温下放置 2 小时后、48 小时内测 试。 The test sample shall be placed at (-40±3)°C and (85±2)°C for (30±3) min, different temperature conversion time is 2~3 minutes. The temperature cycle shall be repeated 32 cycles. Test within 48 hours after 2 hours of placement at room temperature.
7.8	温度特性 Temperature characteristic	电感量变化率 $P_{c-b}, P_{c-d}$ 不超过 ±20%。 Inductance change $P_{c-b}, P_{c-d}$ : Within ±20%	a: +20 °C (30~45) min → b: -40 °C (30~45) min → c: +20 °C (30~45) min → d: +85 °C (30~45) min → e: +20 °C (30~45) min  $P_{c-b} = \frac{L_b - L_c}{L_c} \times 100\%$ ; $P_{c-d} = \frac{L_d - L_c}{L_c} \times 100\%$
7.9	恒定湿热 Constant damp heat	外观无可见机械损伤； 电感量变化率：±10%以内。 No visible mechanical damage. Inductance change: Within ±10%	将电感器放置在于湿度(90~95)%RH,温度 60 °C±2 °C的环境中存放 1000 <sup>+24</sup> h, 在室温下放 置 2 小时后、48 小时内测试。 Place inductors in humidity (90~95)%RH, 60 °C ± 2 °C temperature 1000 <sup>+24</sup> h, Test within 48 hours after 2 hours of placement at room temperature.
7.10	高温负载 (寿命) High-temperature load (Life-span)	外观无可见机械损伤； 电感量变化率：±10%以内。 No visible mechanical damage. Inductance change: Within ±10%	温度 85 °C±2°C, 时间 1000 <sup>+24</sup> h,施加额定电流, 在室温下放置 2 小时后、48 小时内测试。 Temperature 85 °C ± 2 °C, Time 1000 <sup>+24</sup> h, Apply a rated current, Test within 48 hours after 2 hours of placement at room temperature.  注：加载电流时零件表面温度超过 125°C的, 需 要对电流降额到零件表面温度不超过 125°C。 Note: If the surface temperature of the part over 125 °C when the current is loaded, the current need to reduce until the surface temperature of the part less than 125 °C.



## 8. 包装 Package

### 8.1. 载带尺寸 Tape Dimension(单位: 毫米 Unit:mm)

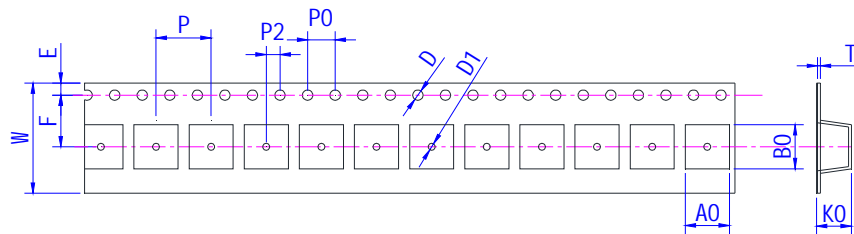

W	A0	B0	D	D1	E	F	K0	P0	P2	P	T
16±0.5	7.6±0.3	7.6±0.3	1.5±0.3	1.5±0.3	1.75±0.3	7.5±0.3	3.9±0.3	4.0±0.3	2.0±0.3	12.0±0.3	0.35±0.10

### 8.2. 供料方向 Direction of feed(单位: 毫米 Unit:mm)

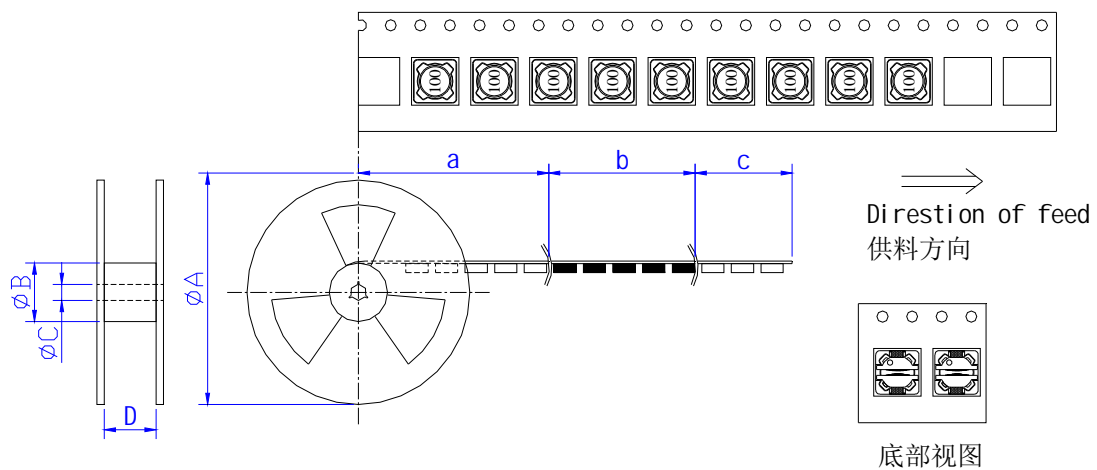

A	B	C	D	a	b	c
330 Typical	100 Typical	13 Typical	16.4 Typical	空带 Blank portions	装元件 Chip cavity	引带 Leader

### 8.3. 包装数量 Packing quantity

卷盘 Reel (PCS)	纸盒 Box (PCS)	纸箱 Carton (PCS)
1,500	6,000	18,000

### 8.4. 剥离力要求 Peeling required

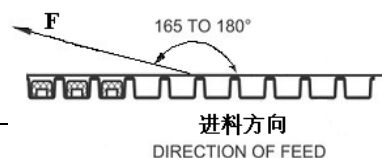



- 8.4.1. F 力大小 F force: 10~130g;
- 8.4.2. 面带剥离速度 Peeling speed: 300mm/min±10%;
- 8.4.3. 面带剥离角度 Peeling angle: 165°~180°。

## 9. 环保情况说明 Environmental Protection Statement

RoHS 指令：公司产品符合 RoHS 指令。

Response to RoHS directive: Our products are RoHS compliance.

## 10. 推荐使用的焊接曲线 Recommended soldering profile

10.1. 本产品建议使用回流焊接法。

Applicable soldering process to the products is reflow soldering.

10.2. 焊接材料 Soldering Materials

(1) 焊料 Solder: Sn-3.0Ag-0.5Cu

(2) 助焊剂：使用松香基助焊剂，禁止使用卤化物含量超过 0.2wt% 的强酸性助焊剂和水溶性助焊剂。

Flux: Use rosin-based flux, but not strongly acidic flux (with chlorine exceeding 0.2 wt%). Do not use water-soluble flux.

10.3. 焊接曲线 Soldering Profile

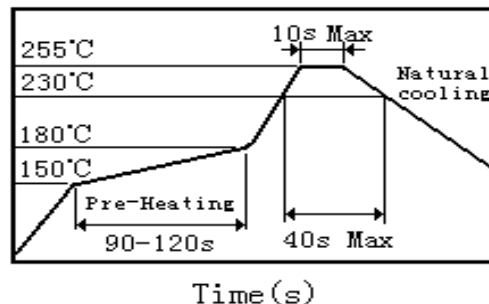

10.4. 烙铁焊接 Soldering Iron

使用烙铁进行返修时要求在 150°C 下预热至少 1 分钟，不能直接用焊头接触磁体，返修焊接条件如下：

Reworking with electric soldering iron must preheating at 150°C for 1 minute is required, and do not directly touch the core with the tip of the soldering iron. The reworking soldering conditions are as follows:

- 10.4.1. 烙铁头温度 Temperature of soldering iron tip: 350°C;
- 10.4.2. 烙铁输出功率 Soldering iron power output: ≤30W;
- 10.4.3. 烙铁头直径 Diameter of soldering iron end: ≤1.0mm;
- 10.4.4. 焊接时间 Soldering time: <3 s



## 11. 清洗 Cleaning

对本产品进行清洗操作前，需确认以下条件：

The following conditions should be observed when cleaning the products:

- 11.1. 清洗温度：≤60°C（酒精清洗剂≤40°C）  
Cleaning Temperature: 60°C max. (40°C max. for alcohol cleaning agents)
- 11.2. 超声波清洗，Ultrasonic:
  - 输出 Output: 20 W/L max.
  - 持续时间 Duration: 5 min max.



频率 Frequency: 28 to 40kHz

11.3. 清洗时要避免 PCB 板和安装产品的共振。Avoid the resonance between PCB and mounted products when it is cleaning.

## 12. 贮存方法 Storage Methods

### 12.1. 存储期限 Storage Period

为保证端子电极的焊接特性和包装材料处于良好状态，请于本公司发货后 6 个月内使用本产品。同时，由于端子电极的焊接特性会随时间发生变化，如果贮存时间超过 6 个月，请首先确认其焊接特性后再安装使用。

To maintain the solderability of terminal electrodes and to keep the packing material in good condition, product should be used within 6 months from the time of delivery. And the solderability of products electrodes may decrease as time passes, so in case of storage over 6 months, solderability shall be checked before actual usage.

### 12.2. 存储条件 Storage Conditions

12.2.1. 存放货物的仓库应满足以下条件：Store products in a warehouse in compliance with the following condition:

温度(Temperature): Inductors (product with taping) -10 to +40°C;

Inductors body -40 to +85°C.

相对湿度(Humidity): 30~70%RH.

12.2.2. 不要使产品遭受温度和湿度的快速变化。Do not subject products to rapid changes in temperature and humidity.

12.2.3. 不要将产品存放在化学环境中，如硫酸气体或碱性气体中，否则会降低电极端子的焊接特性和使电感器腐蚀。Do not store the products in chemical atmosphere such as one containing sulfurous acid gas or alkaline gas, that will causes poor solderability and corrosion of inductors.

12.2.4. 不要以散包装的形式存放产品以防止电感器间的相互碰撞造成磁芯破裂或断线。Do not store products in bulk packaging to prevent collision among inductors which causes core chipping and wire breakage.

12.2.5. 为了避免受潮气、灰尘等物质的影响，产品应保管于货架上。Store products on pallets to protect from humidity, dust, etc.

12.2.6. 产品应避免热冲击、振动以及直接光照等等。Avoid heat shock, vibration, direct sunlight, etc.

## 13. 使用注意事项 Precautions For Use

13.1. 本公司产品适用于 AV 设备、OA 设备、家电、信息服务等一般电子设备中。Our products are designed and promoted for use in general electronic devices such as audio-equipment, office automation equipment, household appliance and information service.

13.2. 当本公司的产品使用在一般电子设备以外的领域时，对于此所引发的设备失效我司将不承担任何法律责任。In case of using the product for the purpose other than general electronics devices, we shall not be held liable for any dysfunctions in or damage to the equipment with which the product is used.

13.3. 本承诺书只保证我司产品作为一个单体时的质量情况，当我司产品被安装到贵公司产品上时，请贵司对使用在贵司电路上的产品情况进行了有效评价和确认。Our specification limits the quality of the component as a single unit. Please ensure the component is thoroughly evaluated in your application circuit.



- 13.4. 不要对产品施加过大的振动或机械冲击； Do not apply excessive vibration or mechanical shock to products.
- 13.5. 为防止断线，请不要使用锋利的物体接触线圈，如镊子； Do not touch wire with sharp objects such as tweezers to prevent wire breakage.
- 13.6. 在产品贴装时不要使用过大的压力，避免磁芯断裂。 Do not apply excessive stress to products mounted on boards to prevent core breakage.

## X-ON Electronics

Largest Supplier of Electrical and Electronic Components

*Click to view similar products for [Fixed Inductors](#) category:*

*Click to view products by [Fenghua Advanced](#) manufacturer:*

Other Similar products are found below :

[CR43NP-680KC](#) [CR54NP-470LC](#) [CR54NP-820KC](#) [CR54NP-8R5MC](#) [70F224AI](#) [MGDQ4-00004-P](#) [MHL1ECTTP18NJ](#) [MHQ1005P10NJ](#)  
[MHQ1005P1N0S](#) [MHQ1005P2N4S](#) [MHQ1005P3N6S](#) [MHQ1005P5N1S](#) [MHQ1005P8N2J](#) [PE-51506NL](#) [PE-53601NL](#) [PE-53602NL](#) [PE-53630NL](#) [PE-53824SNLT](#) [PE-92100NL](#) [PG0434.801NLT](#) [PG0936.113NLT](#) [9220-20](#) [9310-16](#) [PM06-2N7](#) [PM06-39NJ](#) [A01TK](#) [1206CS-471XJ](#) [HC2LP-R47-R](#) [HC2-R47-R](#) [HC3-2R2-R](#) [HC3-R50-R](#) [HC8-1R2-R](#) [HCF1305-3R3-R](#) [1206CS-151XG](#) [RCH664NP-140L](#) [RCH664NP-4R7M](#) [RCH8011NP-221L](#) [RCP1317NP-332L](#) [RCP1317NP-391L](#) [RCR1010NP-470M](#) [RCR110DNP-331L](#) [DH2280-4R7M](#) [DS1608C-106](#)  
[ASPI-4020HI-R10M-T](#) [B10TJ](#) [B82498B3680J000](#) [ELJ-RE27NJF2](#) [1812CS-153XJ](#) [1812CS-183XJ](#) [1812CS-223XJ](#)