



承 认 书

APPROVAL SHEET

客户名称: _____

CUSTOMER

品 名: 常规厚膜片式固定电阻器

PARTNAME GENERAL THICK FILM CHIP FIXED RESISTOR

RC-005 * * *

RC-01 * * *

RC-02 * * *

RC-03 * * */ RS-03 * * *

RC-05 * * */ RS-05 * * *

RC-06 * * */ RS-06 * * *

规 格: RC-1210 * * */ RS-1210 * * *

RC-10 * * */ RS-10 * * *

RC-12 * * *

SPECIFICATION

版 本 号: R-6.1

VERSION

日 期:

DATE

制 造			客 户		
APPROVAL			APPROVAL		
拟制	审核	确认	检验	审核	批准



序号 No	目 录 TABLE OF CONTENTS
1.0	概述 Summary
2.0	结构及尺寸 Structure And Dimensions
3.0	型号规格表示办法 How To Order
4.0	电气性能 Performance Specification
5.0	可靠性 Reliability Data
6.0	包装 Package
7.0	环保情况说明 Environmental Protection Statement
8.0	推荐使用的焊接曲线 Recommended soldering profile
9.0	贮存方法 Storage Methods
10.0	使用注意事项 Precautions For Use



常规片式电阻器承认书 Approval Sheet for General Chip Resistor

版本号 Version of: R-6.1

RC/RS□□□□

1.0 概述 Summary

片式电阻器主要生产的型号包括 01005、0201、0402、0603、0805、1206、1210、2010、2512。其特点是：
The dimension type for chip resistor including 01005、0201、0402、0603、0805、1206、1210、2010、2512, and the features are as below:

- | | |
|-------------------|---|
| *体积小、重量轻 | miniature and light weight |
| *电性能稳定，可靠性高 | stable electrical capability and high reliability |
| *机械强度高、高频特性优越 | superior mechanical and frequency |
| *装配成本低，并与自动装贴设备匹配 | low assembly cost, suit for automatic SMT |
| *适应再流焊与波峰焊 | suit for re-flow and wave flow soldering . |
| *符合 RoHS 指令要求 | Compliant with RoHS Directive |
| *符合无卤素要求 | Compliant with halogen free requirement |

产品广泛应用于计算机、通讯、工业自动化、航天航空、军事、数字电视、数字音响及消费类电子等领域。
The applications for the chip resistor are wildly in computer, communication, industry automatization, aviation, military, digital TV, digital acoustics and consume electronics, etc.

2.0 结构及尺寸 Structure And Dimensions

2.1 结构 Structure

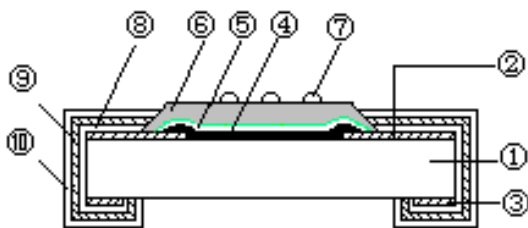

结构层 Structure	主要成分 Main Substance
①陶瓷基片 Substrate	三氧化二铝 Al ₂ O ₃
②面电极 Face Electrode	银电极 Ag,
③背电极 Reverse Electrode	银电极 Ag
④电阻体 Resistive Element	氧化钌、玻璃 Ruthenium oxide , glass
⑤一次保护层 1 st protective coating	玻璃 Glass
⑥二次保护层 2 nd protective coating	树脂 Resin
⑦标记 Marking	树脂 Resin
⑧端电极 Inner Termination	镍铬合金 Ni-Cr
⑨中间电极 Middle Termination	镍层 Ni Plating
⑩外部电极 Outer Termination	锡层 Tin Plating



常规片式电阻器承认书 Approval Sheet for General Chip Resistor

版本号 Version of: R-6.1

RC/RS□□□□

2.2 尺寸 Dimensions

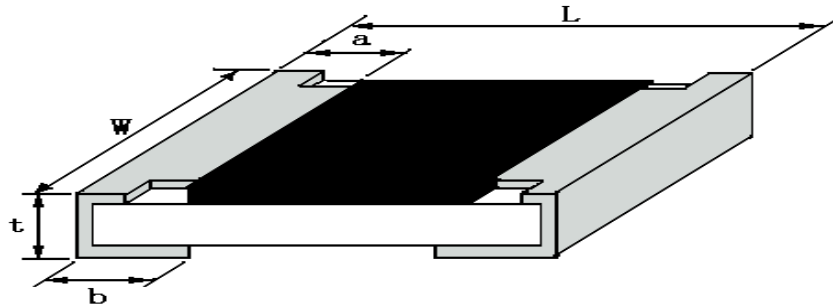

型号 Type	L (mm)	W (mm)	t (mm)	a (mm)	b (mm)
01005	0.40±0.02	0.20±0.02	0.13±0.03	0.10±0.03	0.10±0.03
0201	0.60±0.05	0.30±0.05	0.23±0.03	0.10±0.05	0.15±0.05
0402	1.00±0.10	0.50±0.10	0.30±0.10	0.20±0.10	0.25±0.10
0603	1.60±0.15	0.80±0.15	0.40±0.10	0.30±0.20	0.30±0.20
0805	2.00±0.20	1.25±0.15	0.50±0.10	0.30±0.20	0.40±0.20
1206	3.20±0.20	1.60±0.15	0.55±0.10	0.50±0.20	0.50±0.20
1210	3.20±0.20	2.50±0.20	0.55±0.10	0.50±0.20	0.50±0.20
2010	5.00±0.20	2.50±0.20	0.55±0.10	0.60±0.20	0.60±0.20
2512	6.40±0.20	3.20±0.20	0.55±0.10	0.60±0.20	0.60±0.20

2.3 产品外观 Appearance

2.3.1 电阻器表面二次保护层保护膜覆盖完好且难以脱落,表面平整;

The surface of resistor is covered with Protecting Coating which hard to fade, and the surface of coating should avoid unevenness.

2.3.2 电阻器端电极覆盖均匀、镀层较难脱落、而且平整、无开裂、针孔、变色;

The terminal part is covered equable, the plating is hard to fade, and should avoid unevenness, flaw, pinhole and discoloration.

2.3.3 电阻器芯片无裂痕、标记可辨。

With a clear mark, the resistor body is crack-free.



常规片式电阻器承认书 Approval Sheet for General Chip Resistor

版本号 Version of: R-6.1

RC/RS□□□□

3.0 型号规格表示办法 How To Order

额定功率系列代号 Power Rating Series	
C	常规功率系列 Normal Power Series
S	提升功率系列 Upgraded Power Series

电阻温度系数代号 Resistance Temperature Coefficient Code				
01005	B	±300ppm/°C		
	L	±250ppm/°C		
0201	W	±200ppm/°C		
	U	±400ppm/°C		
0402	K	±100ppm/°C		
	W	±200ppm/°C		
	U	±400ppm/°C		
0603 0805 1206 1210 2010 2512	K	±100ppm/°C		
			L	±250ppm/°C
	跨接电阻 Chip Jumper	无表示 No marking		

包装方式代号 Packing Style Code	
T	编带包装 Tape & Reel
C	塑料袋散装 Case

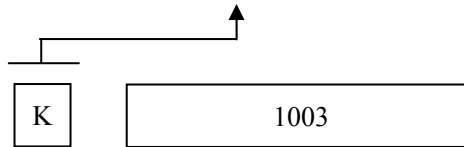
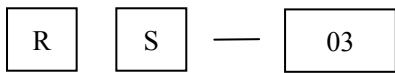

产品代号
Product Code

厚膜片式电阻器
Thick Film Chip
Fixed Resistor

代号 Code	型号 Type
005	01005
01	0201
02	0402
03	0603
05	0805
06	1206
1210	1210
10	2010
12	2512

电阻值代号 Resistance Value Code	
三位数 (E-24 系列): 前两位表示有效数字, 第三位表示有效数字后零的个数。Three digits (E-24 series): The first two digits are significant figures and the third one denotes number of zeros.	
四位数 (E-96 系列): 前三位表示有效数字, 第四位表示有效数字后零的个数。Four digits (E-96 series): The first three digits are significant figures and the four one denotes number of zeros.	
小数点用 R 表示。Decimal point should be expressed by "R".	
"000" 表示跨接电阻。Jumper is expressed by "000"	
例如 Example :	
103=10KΩ (E-24)	
1003=100KΩ (E-96)	
1R0=1.0Ω	
000=0Ω	

电阻值误差精度代号 Resistance Tolerance Code		
D	±0.5%	
F	±1%	
G	±2%	
J	±5%	
跨接电阻 Chip Jumper	F	≤10mΩ
	G	≤20mΩ
	J	≤50mΩ



常规片式电阻器承认书 Approval Sheet for General Chip Resistor

版本号 Version of: R-6.1

RC/RS□□□□

3.1 标记表示方法 The Explanation For The Resistance Value Marking

IEC E-24、E-96 系列电阻值对照表

IEC E-24、E-96 Series Resistance Cross-reference List

E-24 系列 (E-24 series)

($\times 10^n \Omega$)

(单位 unit: 1Ω、10Ω、100Ω、1KΩ、10KΩ、100KΩ、1MΩ、10MΩ)

表一 Table one

1.0	1.5	2.2	3.3	4.7	6.8
1.1	1.6	2.4	3.6	5.1	7.5
1.2	1.8	2.7	3.9	5.6	8.2
1.3	2.0	3.0	4.3	6.2	9.1

E-96 系列 (E-96 series)

($\times 10^n \Omega$)

(单位: 1Ω、10Ω、100Ω、1KΩ、10KΩ、100KΩ、1MΩ、10MΩ)

表二 Table two

1.00	1.33	1.78	2.37	3.16	4.22	5.62	7.50
1.02	1.37	1.82	2.43	3.24	4.32	5.76	7.68
1.05	1.40	1.87	2.49	3.32	4.42	5.90	7.87
1.07	1.43	1.91	2.55	3.40	4.53	6.04	8.06
1.10	1.47	1.96	2.61	3.48	4.64	6.19	8.25
1.13	1.50	2.00	2.67	3.57	4.75	6.34	8.45
1.15	1.54	2.05	2.74	3.65	4.87	6.49	8.66
1.18	1.58	2.10	2.80	3.74	4.99	6.65	8.87
1.21	1.62	2.15	2.87	3.83	5.11	6.81	9.09
1.24	1.65	2.21	2.94	3.92	5.23	6.98	9.31
1.27	1.69	2.26	3.01	4.02	5.36	7.15	9.53
1.30	1.74	2.32	3.09	4.12	5.49	7.32	9.76



常规片式电阻器承认书 Approval Sheet for General Chip Resistor

版本号 Version of: R-6.1

RC/RS□□□□

■E-24 系列：采用三位数字表示，前二位表示电阻值有效数字，第三位表示乘以 10 的次方数。

E-24 series: Express resistance value on the glass side with three digits, the first two digits should be significant and the third one denote number of zeros.

例 For example:

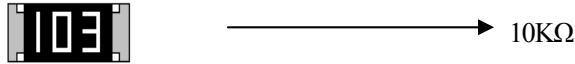

■E-96 系列：

▲0805、1206、1210、2010、2512 采用四位数字表示，前三位表示电阻值有效数字，第四位表示乘以 10 的次方数。

E-96 series: For the dimension type of 0805,1206,2010,2512 express the resistance value with four digits, the first three digits are significant figures and the fourth denotes the number of zeros.

例 For example:

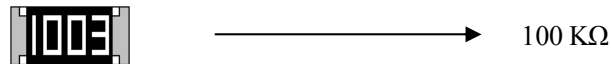

▲0603 用三位代码表示，前二位表示 E-96 系列阻值代码，后一位字母表示乘数代码（见表三和表四）。

For the dimension type of 0603, express the resistance value with three code, the first two digit code denote the resistance of E-96 series, and the third code of letter denote the multiplier (see the table three and four).

例 For example:

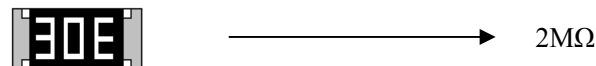

■小数点以“R”表示 The decimal point should be expressed by “R”.

例 For example:

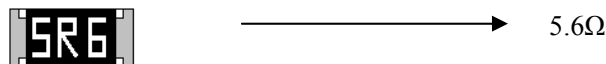

■跨接电阻以“0”表示 The jumper should be expressed by “0”.

例 For example:

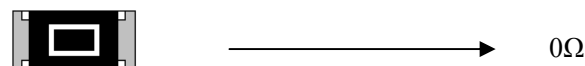

■01005、0201、0402：不作标记 For the dimension type of 01005、0201、0402, there is no mark on the glass side.

例 For example:



■非 IEC 标准系列的电阻值标记表示方法：一般以最接近 IEC E-24 系列标称阻值的标记表示方法。

For the resistance which does not belong to IEC serial, use the resistance of IEC serial which is most close to the required resistance of non-IEC serial for replacement.

■客户对标记有特殊要求时，则按照协商的结果印刷标记

To get agreement by both party if there special requirement for the marking.



常规片式电阻器承认书 Approval Sheet for General Chip Resistor

版本号 Version of: R-6.1

RC/RS□□□□

表三 Table three:

E-96 系列阻值代码 E-96 Series Resistance Value Code

代号 Code	E-96 阻值 The resistance of E-96 series	代号 Code	E-96 阻值 The resistance of E-96 series	代号 Code	E-96 阻值 The resistance of E-96 series	代号 Code	E-96 阻值 The resistance of E-96 series
01	100	25	178	49	316	73	562
02	102	26	182	50	324	74	576
03	105	27	187	51	332	75	590
04	107	28	191	52	340	76	604
05	110	29	196	53	348	77	619
06	113	30	200	54	357	78	634
07	115	31	205	55	365	79	649
08	118	32	210	56	374	80	665
09	121	33	215	57	383	81	681
10	124	34	221	58	392	82	698
11	127	35	226	59	402	83	715
12	130	36	232	60	412	84	732
13	133	37	237	61	422	85	750
14	137	38	243	62	432	86	768
15	140	39	249	63	442	87	787
16	143	40	255	64	453	88	806
17	147	41	261	65	464	89	825
18	150	42	267	66	475	90	845
19	154	43	274	67	487	91	866
20	158	44	280	68	499	92	887
21	162	45	287	69	511	93	909
22	165	46	294	70	523	94	931
23	169	47	301	71	536	95	953
24	174	48	309	72	549	96	976

表四 Table four:

乘数代码 Multiplied Code

乘数次方 multiplier	$\times 10^0$	$\times 10^1$	$\times 10^2$	$\times 10^3$	$\times 10^4$	$\times 10^5$	$\times 10^6$	$\times 10^7$	$\times 10^{-1}$	$\times 10^{-2}$	$\times 10^{-3}$
代 码 code	A	B	C	D	E	F	G	H	X	Y	Z



常规片式电阻器承认书 Approval Sheet for General Chip Resistor

版本号 Version of: R-6.1

RC/RS□□□□

4.0 电气性能 Performance Specification

项目 Item	规格 Specification									
型号 Type	01005	0201	0402	0603	0805	1206	1210	2010	2512	
常规功率系列 Normal Power Series	1/32W	1/20W	1/16W	1/16W	1/10W	1/8W	1/4W	1/2W	1W	
提升功率系列 Upgraded Power Series	/	/	/	1/10W	1/8W	1/4W	1/3W	3/4W	/	
注：当使用环境温度超过 70℃时应按“负荷下降曲线”（见下图）降负荷。 Remark: When used at ambient temperature over 70℃, the load power should be reduced as “Power Derating Curve” shown below.										
70℃下 额定功率 Rated Power at 70℃ (W)	负荷下降曲线 Power Derating Curve									
	<p>使用温度范围： ① Operating Temperature Range: -55℃~125℃ ② Operating Temperature Range: -55℃~155℃</p>									
注： 曲线①适用于 01005、0201 规格产品，使用温度范围为-55℃~+125℃。 曲线②适用于 0402、0603、0805、1206、1210、2010、2512 规格产品，使用温度范围为-55℃~+155℃。										
Remark: Curve ① apply for 01005、0201 chip resistor, operating temperature range is -55℃~+125℃. Curve ② apply for 0402、0603、0805、1206、1210、2010、2512 chip resistor, operating temperature range is -55℃~+155℃.										
额定电压 及元件极 限电压 Rated Voltage & Limiting Element Voltage (V)	每一阻值额定电压根据下列公式计算出，当计算出的额定电压超过表中元件极限电压时，所使用的额定电压应为表中元件极限电压。 The rated voltage at each resistance should be calculated. From the equation below, and when the rated voltage exceeds the Limiting Element Voltage shown in the table, the rated voltage used should be Limiting Element Voltage.									
	$E = \sqrt{P \times R}$ E: 额定电压 Rated Voltage (V) R: 标称阻值 Normal Resistance (Ω) P: 额定功耗 Rated Power (W)	型号 Type	元件极限电压 Limiting Element Voltage							
	01005	15V								
	0201	25V								
	0402	50V								
	0603	50V								
	0805	150V								
	1206	200V								
	1210	200V								
	2010	200V								
	2512	200V								



常规片式电阻器承认书 Approval Sheet for General Chip Resistor							版本号 Version of: R-6.1		
RC/RS□□□□									
续上页 Continue									
项 目 Item	标 准 Specification								
最大过负载电压 Max. Overload Voltage	最大过负荷电压为：2.5 倍额定电压(2.5×E) 当计算出的电压值超过下表中最大过负荷电压时,按下表： The Max. Overload Voltage should be 2.5×E, When the Voltage exceeds the maximum overload voltage in the table below. The value shown in the table should be the maximum one.								
	01005	0201	0402	0603	0805	1206	1210	2010	2512
	30V	50V	100V	100V	300V	400V	400V	400V	400V
跨接电阻额定电流 Rated Current for Chip Jumper	01005	0201	0402	0603	0805	1206	1210	2010	2512
	0.5A	0.5A	1A	1A	2A	2A	2A	2A	2A
跨接电阻最大过负 载电流 Max. Overload Current for Chip Jumper	01005	0201	0402	0603	0805	1206	1210	2010	2512
	1A	1A	2A	3A	5A	5A	5A	5A	5A
标称阻值 允许偏差 Resistance Tolerance	01005	±1%、±2%、±3%、±5% 跨接电阻 Chip Jumper: ≤50mΩ、≤20mΩ、≤10mΩ							
	0201	±0.5%、±1%、±2%、±5% 跨接电阻 Chip Jumper: ≤50mΩ、≤20mΩ、≤10mΩ							
	0402								
	0603								
	0805								
	1206								
	1210								
	2010								
2512									
阻值范围 Resistance Range	01005	10Ω ≤ R ≤ 1MΩ, 0Ω (跨接电阻 Chip Jumper)							
	0201	1Ω ≤ R ≤ 10MΩ 0Ω (跨接电阻 Chip Jumper)							
	0402								
	0603								
	0805								
	1206								
	1210								
	2010								
2512									
使用温度范围 Temperature Range of Use	01005	-55℃ ~ +125℃							
	0201								
	0402	-55℃ ~ +155℃							
	0603								
	0805								
	1206								
1210									
2010									
2512									
额定温度 Rated Temperature	+70℃								



常规片式电阻器承认书 Approval Sheet for General Chip Resistor				版本号 Version of: R-6.1				
RC/RS□□□□								
5.0 可靠性 Reliability								
项目 Item	标准 Specification							
电阻温度系数 Resistance Temperature Coefficient (PPM/°C)	型号 Type	电 阻 值 Resistance	电阻值精度 Resistance Tolerance					
			±0.5%	±1%	±2%	±5%	±10%	
	01005	$10\ \Omega \leq R < 100\ \Omega$	/	±300	±300	±300	±300	
		$100\ \Omega \leq R \leq 1M\ \Omega$	/	±250	±250	±250	±250	
	0201	$1\ \Omega \leq R < 10\ \Omega$	/	±400	±400	±400	±400	
		$10\ \Omega \leq R \leq 1M\ \Omega$	±200	±200	±200	±200	±200	
		$1M\ \Omega < R \leq 10M\ \Omega$	/	±400	±400	±400	±400	
	0402	$1\ \Omega \leq R < 10\ \Omega$	/	±400	±400	±400	±400	
		$10\ \Omega \leq R < 100\ \Omega$	±200	±200	±200	±200	±200	
		$100\ \Omega \leq R \leq 1M\ \Omega$	±100 or ±200	±100 or ±200	±100 or ±200	±100 or ±200	±100 or ±200	
		$1M\ \Omega < R \leq 10M\ \Omega$	/	±400	±400	±400	±400	
	0603 0805 1206 1210 2010 2512	$1\ \Omega \leq R < 10\ \Omega$	/	±250	±250	±250	±250	
		$10\ \Omega \leq R \leq 1M\ \Omega$	±100	±100	±100	±100	±100	
		$1M\ \Omega < R \leq 10M\ \Omega$	/	±250	±250	±250	±250	
	试验方法 Test Method (IEC 60115-1)	IEC 60115-1 4.8 +20°C/-55°C/+20°C/+125°C/+20°C						



常规片式电阻器承认书 Approval Sheet for General Chip Resistor		版本号 Version of: R-6.1	
RC/RS□□□□			
续上页			
项目 Item	标准 Specification		试验方法 Test Method (IEC 60115-1)
	片状电阻器 Resistor	跨接电阻 Jumper	
可焊性 Solder ability	可焊面积≥95%. The termination coverage should be 95% cover min		IEC 60115-1 4.17 245°C±5°C锡槽, 保持 3s±0.3s Lead-free solder bath at 245°C±5°C for 3s±0.3s
耐焊接热 Resistance to Soldering Heat	无可见损伤 No mechanical damage. $\Delta R \leq \pm (1.0\%R + 0.05\Omega)$	无可见损伤 No mechanical damage. $R \leq 50m\Omega$ (J级) $R \leq 20m\Omega$ (G级) $R \leq 10m\Omega$ (F级)	IEC 60115-1 4.18 270°C±5°C锡槽, 保持 10s±1s Lead-free solder bath at 270°C±5°C for 10s±1s
基板弯曲试验 Substrate Bending Test	无可见损伤 No mechanical damage $\Delta R \leq \pm (1.0\%R + 0.05\Omega)$	无可见损伤 No mechanical damage. $R \leq 50m\Omega$ (J级) $R \leq 20m\Omega$ (G级) $R \leq 10m\Omega$ (F级)	IEC 60115-1 4.33 弯曲距离(Bending distance): 01005: 3mm; 0201、0402、0603、0805: 5mm; 1206、1210: 4mm; 2010、2512: 2mm 保持时间(Duration): 60s±5s
剪切力试验 Shear Test	外观无可见损伤 No mechanical damage		IEC 60115-1 4.32 施加力 (Applying force): 0201: 2N, 0402、0603: 5N, 0805: 9N, 1206、 1210: 25N, 2010、2512: 45N 保持时间(Duration): 10s±1s
温度快速变化 Rapid Change of Temperature	无可见损伤 No mechanical damage 01005: $\Delta R \leq \pm (1.0\%R + 0.05\Omega)$ Others: 0.5%、1%: $\Delta R \leq \pm (0.5\%R + 0.05\Omega)$ 2%、5%、10%: $\Delta R \leq \pm (1.0\%R + 0.05\Omega)$	无可见损伤 No mechanical damage. $R \leq 50m\Omega$ (J级) $R \leq 20m\Omega$ (G级) $R \leq 10m\Omega$ (F级)	IEC 60115-1 4.19 01005、0201: -55°C (30分钟)~常温(5分钟)~125°C (30分钟), 300个循环 01005、0201: -55°C (30min) ~ normal temperature(5min)~125°C(30min), 300 cycles 0402、0603、0805、1206、1210、2010、2512: -55°C (30分钟)~常温(5分钟)~155°C(30分钟), 300个 循环 0402、0603、0805、1206、1210、2010、2512: -55°C (30min) ~ normal temperature(5min) ~ 155°C (30min), 300 cycles
短时间 过负载 Short Time Overload	无可见损伤 No mechanical damage. 01005: $\Delta R \leq \pm (2.0\%R + 0.05\Omega)$ Others: 0.5%、1%: $\Delta R \leq \pm (1.0\%R + 0.05\Omega)$ 2%、5%: $\Delta R \leq \pm (2.0\%R + 0.05\Omega)$	无可见损伤 No mechanical damage. $R \leq 50m\Omega$ (J) $R \leq 20m\Omega$ (G) $R \leq 10m\Omega$ (F)	IEC 60115-1 4.13 2.5倍额定电压或最大过负载电压(取最小 值), 持续5秒。 2.5 times rated voltage or max overload voltage whichever is lower, for 5 seconds.
			IEC 60115-1 4.13 跨接电阻器: 施加最大过负载电流, 持续5秒。 Jumper: Apply the max overload current for 5 seconds.



常规片式电阻器承认书 Approval Sheet for General Chip Resistor		版本号 Version of: R-6.1	
RC/RS□□□□			
续上页			
项目 Item	标准 Specification		试验方法 Test Method (IEC 60115-1)
	片状电阻器 Resistor	跨接电阻 Jumper	
断续过负载 Periodic Pulse Overload Test	无可见损伤 No mechanical damage $\Delta R \leq \pm (5.0\%R + 0.05 \Omega)$	无可见损伤 No mechanical damage. $R \leq 50m\Omega$ (J 级) $R \leq 20m\Omega$ (G 级) $R \leq 10m\Omega$ (F 级)	IEC 60115-1 4.39 2.5 倍额定电压或最大过负荷电压 (取较小值), 通 1 秒断 25 秒, 10000 个循环。 2.5 Times Rated voltage or max. overload voltage whichever is lower, for 1s ON / 25s OFF, 10000 cycles
稳态湿热 Damp Heat, Steady State	无可见损伤 No mechanical damage. 01005、0201、0402、0603、 0805、1206、1210、2010、 2512: $\Delta R \leq \pm (3.0\%R + 0.1\Omega)$	无可见损伤 No mechanical damage. $R \leq 50m\Omega$ (J 级) $R \leq 20m\Omega$ (G 级) $R \leq 10m\Omega$ (F 级)	IEC 60115-1 4.24 电阻器: $40^\circ\text{C} \pm 2^\circ\text{C}$, $93\% \pm 3\%RH$, 1000h, 额定电压或元件极限电压 (取较小值), 通 1.5 小时/断 0.5 小时。 Resistor: $40^\circ\text{C} \pm 2^\circ\text{C}$, $93\% \pm 3\%RH$, 1000h, rated voltage or limiting element voltage whichever is lower for 1.5h ON/0.5h OFF
70℃ 耐久性 Endurance at 70℃	无可见损伤 No mechanical damage. 01005: $\Delta R \leq \pm (3.0\%R + 0.05\Omega)$ Others: 0.5%、1%: $\Delta R \leq \pm (1.0\%R + 0.05 \Omega)$ 2%、5%、10%: $\Delta R \leq \pm (2.0\%R + 0.05 \Omega)$	无可见损伤 No mechanical damage. $R \leq 50m\Omega$ (J 级) $R \leq 20m\Omega$ (G 级) $R \leq 10m\Omega$ (F 级)	IEC 60115-1 4.25.1 $70^\circ\text{C} \pm 2^\circ\text{C}$, 1000 小时, 额定电压或元件极限电压 (取较小值), 通 1.5 小时/断 0.5 小时 $70^\circ\text{C} \pm 2^\circ\text{C}$, 1000h, rated voltage or limiting element voltage whichever is lower for 1.5h ON/0.5h OFF
上限类别 温度耐久性 Endurance at Upper Category Temperature	无可见损伤 No mechanical damage 01005: $\Delta R \leq \pm (3.0\%R + 0.05\Omega)$ Others: 0.5%、1%: $\Delta R \leq \pm (1.0\%R + 0.05 \Omega)$ 2%、5%、10%: $\Delta R \leq \pm (2.0\%R + 0.05 \Omega)$	无可见损伤 No mechanical damage. $R \leq 50m\Omega$ (J 级) $R \leq 20m\Omega$ (G 级) $R \leq 10m\Omega$ (F 级)	IEC 60115-1 4.25.3 01005、0201: $125^\circ\text{C} \pm 2^\circ\text{C}$, 1000h 0402、0603、0805、1206、1210、2010、2512: $155^\circ\text{C} \pm 2^\circ\text{C}$, 1000h

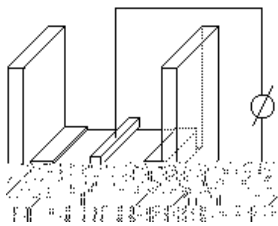

常规片式电阻器承认书 Approval Sheet for General Chip Resistor		版本号 Version of: R-6.1	
RC/RS□□□□			
续上页			
项目 Item	标准 Specification		试验方法 Test Method (IEC 60115-1)
	片状电阻器 Resistor	跨接电阻 Jumper	
低温负载 Operation at Low Temperature	无可见损伤 No mechanical damage 01005: $\Delta R \leq \pm (2.0\%R + 0.05\Omega)$ Others: 0.5%、1%: $\Delta R \leq \pm (1.0\%R + 0.05\Omega)$ 2%、5%、10%: $\Delta R \leq \pm (2.0\%R + 0.05\Omega)$	无可见损伤 No mechanical damage. $R \leq 50m\Omega$ (J 级) $R \leq 20m\Omega$ (G 级) $R \leq 10m\Omega$ (F 级)	IEC 60115-1 4.36 电阻器: $-55^{\circ}\text{C} \pm 5^{\circ}\text{C}$, 无负载 1 小时, 额定电压或 元件极限电压 (取较小值) 45 分钟, 无负载 15 分钟 Resistor: $-55^{\circ}\text{C} \pm 5^{\circ}\text{C}$, 1h without load, rated voltage or limiting element voltage whichever is lower for 45min, 15min without load
			IEC 60115-1 4.36 跨接电阻器: $-55^{\circ}\text{C} \pm 5^{\circ}\text{C}$, 无负载 1 小时, 额定电 流 45 分钟, 无负载 15 分钟。 Jumper: $-55^{\circ}\text{C} \pm 5^{\circ}\text{C}$, 1h without load, rated current for 45min, 15min without load.
耐电压 Voltage Proof	无击穿或飞弧 No breakdown or flashover		IEC 60115-1 4.7 在电极与基片间以大约 100V/s 的速率施加有效值为 最大过负荷电压的交流电压, 保持 60s±5s Apply max. overload voltage of AC RMS at a rate of approximately 100V/s between substrate and terminations for 60s±5s
绝缘电阻 Insulation Resistance	1000MΩ Min		IEC 60115-1 4.6 在电极与基片间施加 100V±15V 直流电压, 保持 1 分钟, 然后测绝缘电阻值。 Apply DC 100V±15V between substrate and termination for 1 minute, then check insulation resistance. 
耐溶剂性 Resistance to Solvent	无可见损伤 No mechanical damage. $\Delta R \leq \pm (1.0\%R + 0.05\Omega)$	无可见损伤 No mechanical damage. $R \leq 50m\Omega$ (J 级) $R \leq 20m\Omega$ (G 级) $R \leq 10m\Omega$ (F 级)	IEC 60115-1 4.29 异丙醇 (IPA), $23^{\circ}\text{C} \pm 5^{\circ}\text{C}$, 浸 10 小时 Iso-propyl alcohol (IPA), $23^{\circ}\text{C} \pm 5^{\circ}\text{C}$, 10h



常规片式电阻器承认书 Approval Sheet for General Chip Resistor

版本号 Version of: R-6.1

RC/RS□□□□

续上页

6.0 包装 Package

6.1 编带包装 Taping

6.1.1 结构尺寸 Dimension And Structure

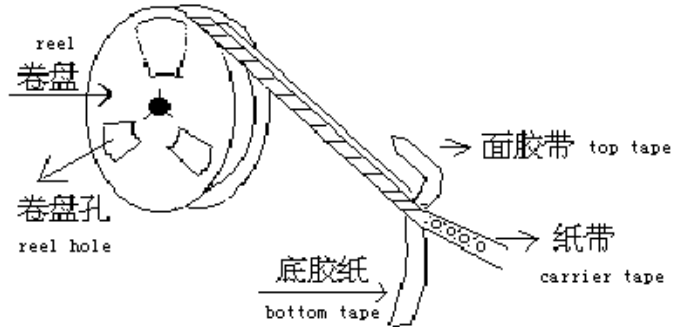

(A) 载带尺寸 Carrier Tape Dimension

■ 纸带编带 Paper Carrier Tape

For 01005、0201、0402 type

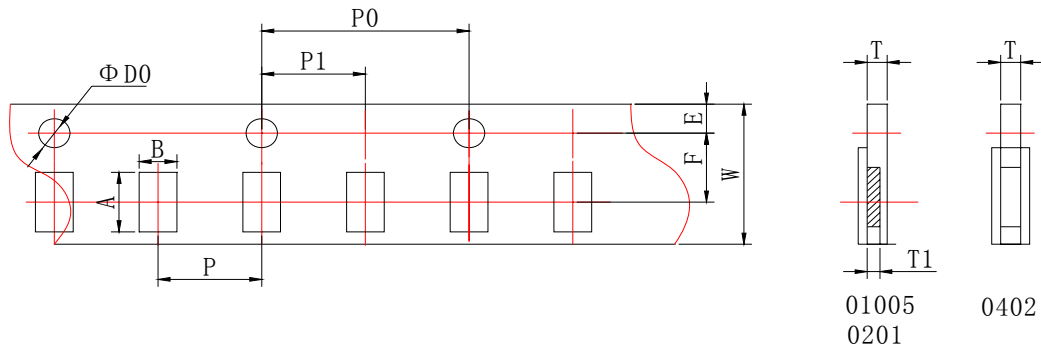

For 0603、0805、1206、1210 type

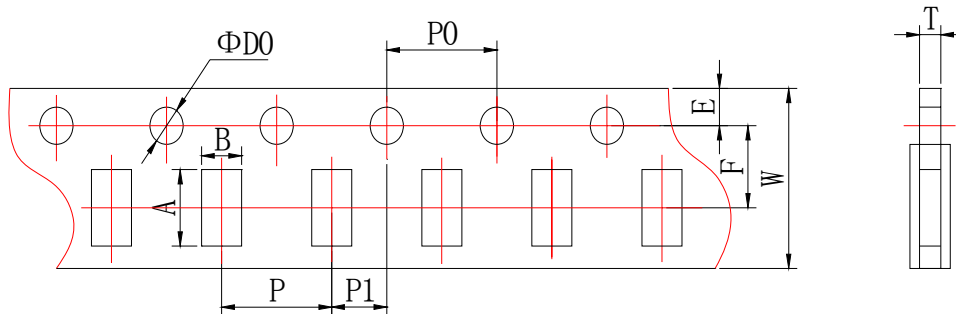



常规片式电阻器承认书 Approval Sheet for General Chip Resistor	版本号 Version of: R-6.1
RC/RS□□□□	

单位 Unit:mm

型号 Type	A	B	W	F	E
01005	0.45±0.02	0.25±0.02	8.00±0.20	3.50±0.05	1.75±0.05
0201	0.70±0.10	0.40±0.10	8.00±0.20	3.50±0.05	1.75±0.10
0402	1.20±0.10	0.70±0.10	8.00±0.20	3.50±0.05	1.75±0.10
0603	1.85±0.10	1.10±0.10	8.00±0.20	3.50±0.05	1.75±0.10
0805	2.35±0.10	1.65±0.10	8.00±0.20	3.50±0.05	1.75±0.10
1206	3.50±0.20	1.90±0.20	8.00±0.20	3.50±0.05	1.75±0.10
1210	3.50±0.20	2.80±0.20	8.00±0.20	3.50±0.05	1.75±0.10

型号 Type	P	P0	P1	ΦD0	T
01005	2.00±0.05	4.00±0.10	2.00±0.05	1.55±0.02	T1: 0.17±0.02 T: 0.31±0.02
0201	2.00±0.05	4.00±0.10	2.00±0.05	1.50±0.10	T1: 0.28±0.04 T: 0.42±0.05
0402	2.00±0.05	4.00±0.10	2.00±0.05	1.50±0.10	0.42±0.05
0603	4.00±0.10	4.00±0.10	2.00±0.05	1.50±0.10	0.60±0.10
0805	4.00±0.10	4.00±0.10	2.00±0.05	1.50±0.10	0.75±0.10
1206	4.00±0.10	4.00±0.10	2.00±0.05	1.50±0.10	0.75±0.10
1210	4.00±0.10	4.00±0.10	2.00±0.05	1.50±0.10	0.75±0.10

备注：01005、0201 型号中 T1 指纸带方孔槽深；T 指纸带厚度。

Remark: For 0201type, T1 refers to the whole depth of paper carrier tape; T refers to the thickness of the paper carrier tape.

■塑料带编带 Embossed tapping

适用于 2010、2512: For 2010、2512:

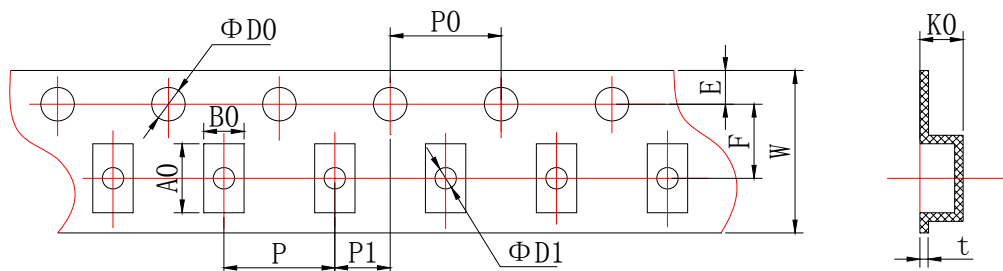



常规片式电阻器承认书 Approval Sheet for General Chip Resistor	版本号 Version of: R-6.1
RC/RS□□□□	

单位 Unit:mm

型号 Type	A0	B0	W	F	E	t
2010	5.50±0.15	2.82±0.15	12.00±0.10	5.50±0.10	1.75±0.10	0.25±0.05
2512	6.78±0.15	3.45±0.15	12.00±0.10	5.50±0.10	1.75±0.10	0.25±0.05

型号 Type	P	P0	P1	ΦD0	ΦD1	K0
2010	4.00±0.10	4.00±0.10	2.00±0.05	1.50+0.10/-0	1.50±0.10	0.84±0.10
2512	4.00±0.10	4.00±0.10	2.00±0.05	1.50+0.10/-0	1.50±0.10	0.81±0.10

(B) 卷盘尺寸 Reel Dimension

型号 Type	M	W	T	A	B	C	D
01005 0201 0402 0603 0805 1206 1210	178±2.0	9.5±1.0	12.5±1.5	2.0±0.5	13.0±0.5	21.0±0.5	58.0±2.0
2010 2512	178±2.0	13.0±0.5	15.5±1.5	2.0±0.5	13.0±0.5	21.0±0.5	57.0±2.0

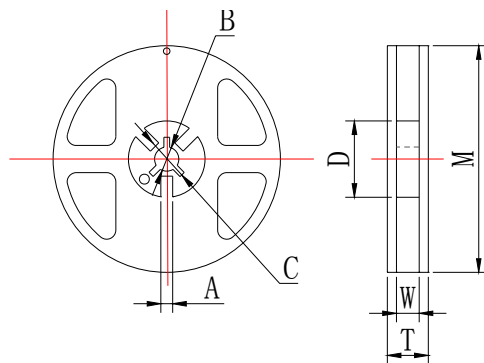

6.1.2 编带包装标准 Taping Specification

(A) 能力 Ability

■面带拉力 top tape peel strength

面带拉力强度为 11~70g(0.1N~0.7N)，速度：300mm/min，经下列试验后不允许有破裂断带现象。
Peel strength is 11~70g(0.1N~0.7N)，with speed of 300mm/min，and should not have flash and tear after peeling.

测试方法 test method:

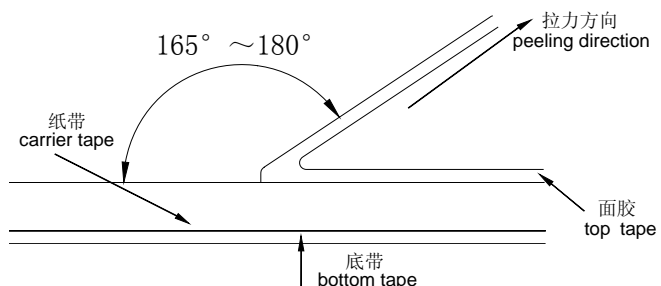



常规片式电阻器承认书 Approval Sheet for General Chip Resistor	版本号 Version of: R-6.1
RC/RS□□□□	

- 电阻松动自如,无粘面、底胶现象.
Resistor is free, no sticking to top tape and bottom tape.
- 电阻易从纸带中取出,且芯片孔无机械损伤.
Resistor is easy to take out from carrier tape and chip hole have no mechanical damage.

(B) 编带包装数量 Quantity In Taping unit: PCS / reel

型号规格 Type	数量 Quantity
01005	20000
0201 0402	10000
0603 0805 1206 1210	5000
2010 2512	4000

(C) 载带说明 Carrier Tape Statement

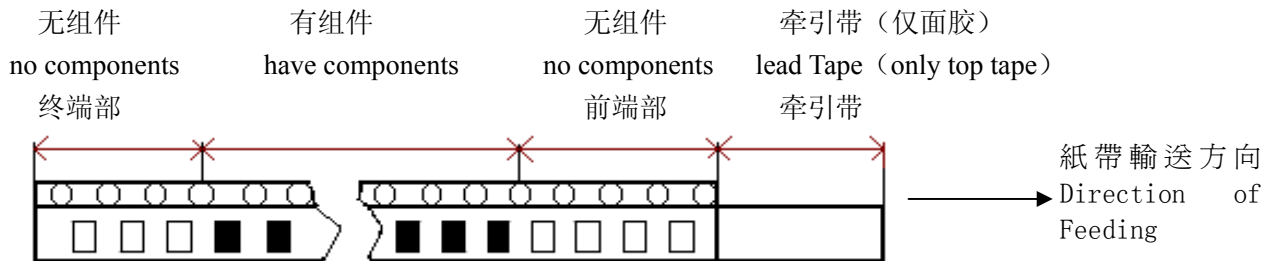

长度 length unit: mm

终端部 terminal	前端部 front	牵引带 lead tape
110~240	350-400	120-140

6.1.3 外包装 Outer Packaging

第一次包装: 数量: 1卷~10卷
the first package : 1~10 reels

第二次包装: 数量: 最多8盒
the second package: 8 case Max

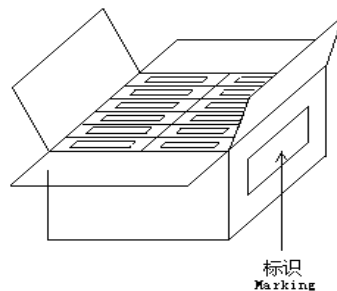
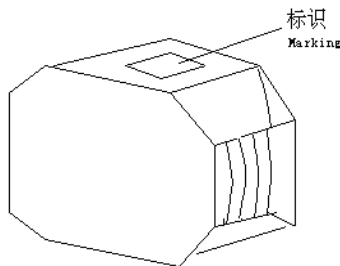

- 当包装数量不能达到最大时,剩余空隙部位采用辅助材料填满。

When quantity shall not reach the max , the remaining empty space shall be buried with buffer material.

- 当数量为最小时,使用别的方法包装,确保运输过程中无问题是至关重要的。

When the quantity is a few, alternative packing methods may be used. It is very important to ensure the safety of the products during transportation.



常规片式电阻器承认书 Approval Sheet for General Chip Resistor	版本号 Version of: R-6.1
RC/RS□□□□	

6.1.4 标签 Label

■卷盘标签 label on the reel

- (1. 客户物料号 customer part No. 2.客户订单号 customer P/O) 3.型号规格 Part No
- 4.数量 quantity 5.标称阻值 resistance 6.额定功率 rated power
- 7.电阻值误差 tolerance 8.出厂日期 delivery date 9.QC 印章 QC marking
- 10. RoHS marking

■内箱标签 label on inner packaging box

- (1. 客户物料 customer part No. 2.客户订单号 customer P/O) 3.型号规格 Part No
- 4.数量 quantity 5.标称阻值 resistance 6.额定功率 rated power
- 7.电阻值误差 tolerance 8.出厂日期 delivery date 9.QC 印章 QC marking
- 10. RoHS marking

■外箱标签 label on outer packaging box

- 1.客户名称 customer name 2.合同编号 contract No. 3.产品名称 product name
- 4.风华型号规格 part No. 5.数量 quantity 6.箱号 case No.
- 7.制造者名称 maker name 8.QC 印章 QC marking 9. 客户订单号: customer P/O
- 10. 客户订单号: customer P/O 11. 客户物料号: customer part No 12. 出货日期: delivery date
- 13. 装箱清单号: Packing list number 14. 毛重: gross weight 15. 净重: net weight

备注 Remark:

①()部分可按客户要求而定。

The content with bracket could be designed according to customers' requirement.

②一般情况下, 环保产品采用“RoHS”标示。

Usually, the environmental product will be used"RoHS" label.

卷盘标签上的环保标识 Environmental Logo on Reel Label	外箱上的环保标识 Environmental Logo on Outer Box



常规片式电阻器承认书 Approval Sheet for General Chip Resistor

版本号 Version of: R-6.1

RC/RS□□□□

7.0 环保情况说明 Environmental Protection Statement

※ 产品符合 RoHS 指令 Compliant with RoHS Directive.

1) 表面处理层 (即外部电极) 无铅 (Pb≤100ppm)

The termination of the chip resistor is lead-free (Pb≤100ppm).

2) 本体中的铅属于 RoHS 指令豁免的“玻璃中的铅”

The Pb in the resistor body is belong to the RoHS exemptions of “Pb in glass material”

※ 根据中国《电子信息产品污染控制管理办法》的规定, 片式电阻器的有害物质情况如下:

According to the requirement of Administration on the Control of Pollution caused by Electronic Information Products, below are the hazardous substance information for the chip resistor:

部件名称 part name	有毒有害物质或元素 hazardous substance					
	铅 (Pb)	汞 (Hg)	镉 (Cd)	六价铬 (Cr ⁶⁺)	多溴联苯 (PBB)	多溴二苯醚 (PBDE)
片式电阻器 chip resistor	×	○	○	○	○	○

○: 表示该有毒有害物质在该部件所有均质材料中的含量均在SJ/T11363-2006标准规定的限量要求以下。

○: Indicates that this toxic or hazardous substance contained in all of the homogeneous materials for this part is below the threshold requirement in SJ/T11363-2006.

×: 表示该有毒有害物质至少在该部件的某一均质材料中的含量超出 SJ/T11363-2006 标准规定的限量要求。

×: Indicates that this toxic or hazardous substance contained in at least one of the homogeneous materials used for this part is above the threshold requirement in SJ/T11363-2006.

※ 产品的环保使用期限标志如下:

The Environment Friendly Use Period logo as below:



备注: 此环保使用期限只适用于产品是在本产品承认书中所规定的条件下工作。

Remarks: Above “Environment Friendly Use Period” only applicable under the condition specified in this approval sheet.

8.0 表面处理无铅片阻推荐使用的焊接曲线 Recommended Soldering Profile

■ 推荐的回流焊曲线 Recommended re-flow profile

回流3次 Re-flow 3 times

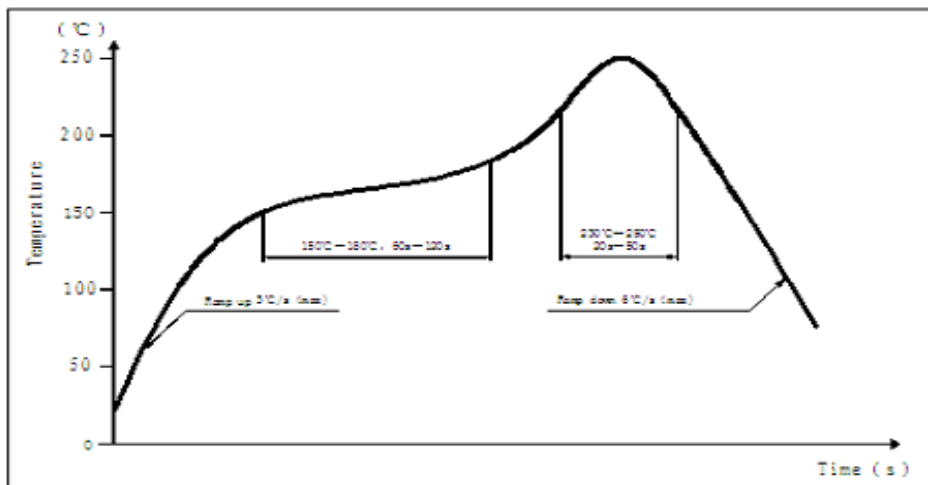



常规片式电阻器承认书 Approval Sheet for General Chip Resistor

版本号 Version of: R-6.1

RC/RS□□□□

■ 推荐的波峰焊曲线 Recommended wave solder profile

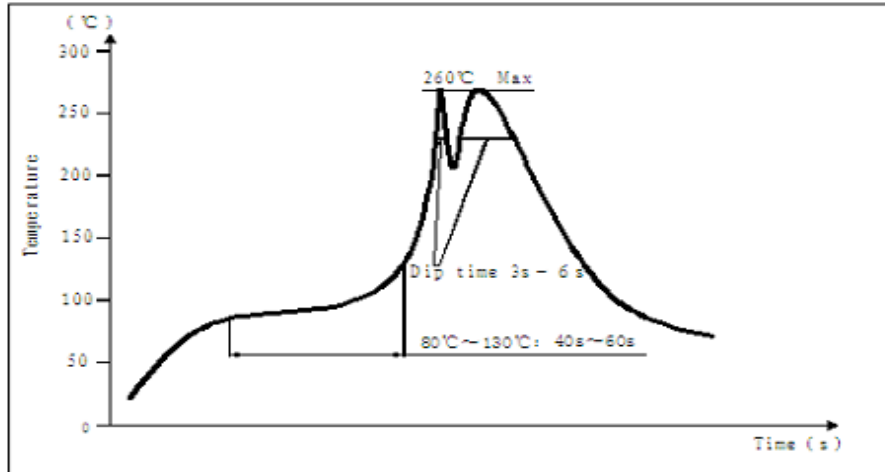

■ 推荐的 焊膏 / 焊锡 类型 Recommended solder alloy: 96.5Sn-3.0Ag-0.5Cu

9.0 注意事项 Precautions

■ 本产品在以下特殊环境下应用，性能可能会受到影响：

Application of the products in a special environment can deteriorate product performance:

- 1、在不同类型的液体，包括水，油，化学品，有机溶剂的使用。
Use in various types of liquid, including water, oils, chemicals, and organic solvents.
- 2、在户外直接暴露在阳光的地方，或在灰尘多的地方使用产品。
Use outdoors where the products are exposed to direct sunlight, or in dusty places.
- 3、在产品暴露的地方，有海风或腐蚀性气体，包括氯气，硫化氢，氨气，二氧化硫，二氧化氮。
Use in places where the products are exposed to sea winds or corrosive gases, including Cl₂, H₂S, NH₃, SO₂, and NO₂.
- 4、在产品暴露于静电或电磁波的地方使用。
Use in places where the products are exposed to static electricity or electromagnetic waves.
- 5、在产生热量的部件、塑料线，或其他易燃物品附近使用。
Use in proximity to heat-producing components, plastic cords, or other flammable items.
- 6、在用树脂或其他涂层材料密封产品的情况下使用。
Use involving sealing or coating the products with resin or other coating materials.
- 7、焊接后使用不洁焊料或使用水或水溶性清洗剂清洗产品。
Use involving unclean solder or use of water or water-soluble cleaning agents for cleaning after soldering.



常规片式电阻器承认书 Approval Sheet for General Chip Resistor

版本号 Version of: R-6.1

RC/RS□□□□

产品使用注意事项 Precautions on use of products

- 1、避免采用超过正常额定功率的功率，超过额定功率的稳态负载条件下可能会对产品性能和可靠性产生负面影响。
Avoid applying power exceeding normal rated power, exceeding the power rating under steady-state loading condition may negatively affect product performance and reliability.
 - 2、用镊子拿起产品时要小心。有可能会将保护或电阻体夹碎。
Be careful when pick up the products with tweezers. There may be a care that the overcoat and / or the body can be chipped.
 - 3、手动安装产品时，烙铁头勿触碰产品。
Soldering tip shall not touch the product when install product manually.
- **贮存条件:温度 5℃~30℃, 相对湿度 30%~70%.**
Storage conditions: T: 5℃~30℃, RH: 30%~70%.
建议在符合以上贮存条件下 6 个月内使用。
The products are suggested to be used within six months when received, and the storage condition mentioned above should be followed.
 - **请您盖章确认后将复印件御返我司，如三个月后未返回我司将视做默认接受。**
Be sure to return a copy to our company after stamping your company acceptance, if no copy returned after three months, we would judge that you shall receive and accept this approval sheet.
 - **如承认书有任何变更，之前的版本自动作废。**
If there is any amendment, a former version shall become invalid.

X-ON Electronics

Largest Supplier of Electrical and Electronic Components

Click to view similar products for [Thick Film Resistors - SMD category:](#)

Click to view products by [Fenghua Advanced manufacturer:](#)

Other Similar products are found below :

[CR-05FL7--150R](#) [CR-05FL7--698K](#) [CR-12JP4--680R](#) [CRCW04021K20FKEE](#) [CRCW04028R20JNEE](#) [CRCW06032K10FKEC](#)
[CRCW06036K80FKEE](#) [M55342K03B499DRS6](#) [M55342K06B6E19RWL](#) [M55342K09B5D62RS6](#) [M55342M06B26E7RS3](#) [742C083750JTR](#)
[MCR01MRTF1001](#) [MCR01MZPF1202](#) [MCR01MZPF1601](#) [MCR01MZPF1800](#) [MCR01MZPF6201](#) [MCR01MZPF9102](#) [MCR01MZPJ121](#)
[MCR01MZPJ125](#) [MCR01MZPJ751](#) [MCR03EZPJ103](#) [MCR03EZPF2004](#) [MCR03EZPJ270](#) [MCR03EZPJ821](#) [MCR10EZPF1102](#)
[MCR10EZPF2700](#) [MCR18EZPJ330](#) [RC1005F1152CS](#) [RC1005F1372CS](#) [RC1005F2052CS](#) [RC1005F471CS](#) [RC1005F4751CS](#)
[RC1005F5621CS](#) [RC1005F6041CS](#) [RC1005J121CS](#) [RC1005J122CS](#) [RC1005J180CS](#) [RC1005J181CS](#) [RC1005J202CS](#) [RC1005J391CS](#)
[RC1005J512CS](#) [RC1005J683CS](#) [RC1005J823CS](#) [RC1608F333CS](#) [RC1608F5110CS](#) [RC1608J121CS](#) [RC2012F2493CS](#) [RC2012F2740CS](#)
[RC2012J105CS](#)