

# 厚膜高壓片式固定電阻器

HIGH VOLTAGE THICK FILM CHIP FIXED RESISTOR

## ■ 厚膜高壓片式固定電阻器

High Voltage Thick Film Chip Fixed Resistor

### ● 特點 Features

- \* 最高工作電壓: 3000V  
Max Operating voltage: 3000V
- \* 電性能穩定, 可靠性高  
Stable electrical capability, high reliability
- \* 機械强度高、高頻特性優越  
Superior mechanical and frequency characteristics
- \* 符合ROHS指令要求  
Compliant with RoHS directive
- \* 符合無鹵素要求  
Halogen free requirement

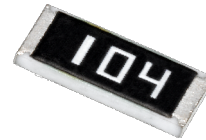

### ● 應用領域 Application

相機閃光燈電路、計算機、打印設備、電池充電器、汽車設備、電源電路、光盤驅動器等。  
Camera Flash Circuit, Computer, Printer, Battery Charger, Automotive, Power supply, CD-ROM, etc.

### ● 品名構成 Type Designation

RV	S	—	06	L	1004	F	T					
產品代號 Product Code	額定功率系列代號 Power Rating Series Code		型號代號 Type Code		電阻溫度系數代號 T.C.R Code			電阻值代號 Resistance Value Code	電阻值誤差精度代號 Resistance Tolerance Code		包裝方式代號 Packaging Style Code	
厚膜高壓片式 固定電阻器 High Voltage Thick Film Chip Fixed Resistor	型號 Type	代號 Code	代號 Code	型號 Type	型號 Type	代號 Code	T.C.R (ppm/°C)	三位數或四位數表示 3 digit or 4 digit 例如: 106=10MΩ 1005=10MΩ	代號 Code	誤差 精度 Tolerance	代號 Code	包裝 方法 Packaging Style
	0603 0805 1206 1210 2010	S	02	0402	0402	K	±100		F	±1%	T	編帶包裝 Tape & Reel
	0402 2512		C	03		0603	W		±200	J		
				05		0805	U		±400	K	±10%	C
		10	1210		0603 0805 1206 1210 2010 2512	L	±250					
		12	2512			M	±500					

### ● 結構 Construction

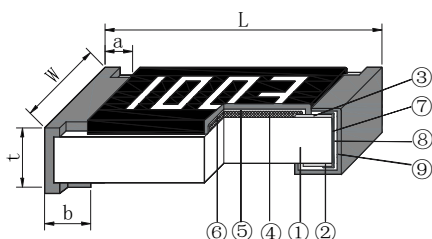

- ① 陶瓷基板 Ceramic Substrate
- ② 背電極 Bottom Electrode
- ③ 面電極 Top Electrode
- ④ 電阻體 Resistor Layer
- ⑤ 一次保護 Primary Overcoat
- ⑥ 二次保護 Secondary Overcoat
- ⑦ 端電極 Edge Electrode
- ⑧ 中間電極 Barrier Layer
- ⑨ 外部電極 External Electrode

### ● 规格尺寸 Dimensions

型號 Type	尺寸 Dimensions(mm)				
	L	W	t	a	b
0402	1.00±0.05	0.50±0.05	0.30±0.05	0.20±0.10	0.20±0.10
0603	1.60±0.10	0.80±0.10	0.45±0.10	0.30±0.20	0.30±0.20
0805	2.00±0.10	1.25±0.15	0.50±0.10	0.30±0.20	0.40±0.20
1206	3.20±0.20	1.60±0.15	0.55±0.10	0.50±0.20	0.50±0.20
1210	3.20±0.20	2.50±0.20	0.55±0.10	0.50±0.20	0.50±0.20
2010	5.00±0.20	2.50±0.20	0.55±0.10	0.60±0.20	0.60±0.20
2512	6.30±0.20	3.20±0.20	0.55±0.10	0.60±0.20	0.60±0.20

### ● 負荷下降曲線 Derating Curve

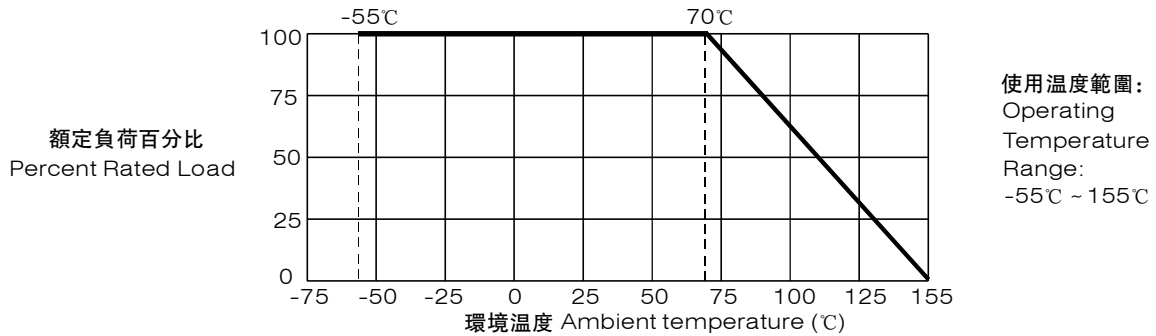

注：當電阻使用的環境溫度超過70°C時，其額定負荷(額定功率)按上述曲線下降。

Note: For resistors operated in ambient over 70°C, rated load (rated power) shall be derated in accordance with the above figure.

### ● 額定值 Ratings

型號 Type	70°C下額定功率 Rating Power at 70°C (W)	元件極限電壓 Limiting Element Voltage (V)	最大過負荷電壓 Max. Overload Voltage (V)
0402	1/16	100	200
0603	1/10	300	600
0805	1/8	400	800
1206	1/4	500	1000
1210	1/3	600	1200
2010	3/4	2000	3000
2512	1	3000	4000

注Note:

1、電壓為直流或交流有效值。

Voltage of DC or AC RMS value.

2、 $E = \sqrt{P \times R}$  或元件極限電壓兩者中的較小值。

$E = \sqrt{P \times R}$  or Limiting element voltage whichever is lower.

E: 額定電壓 Rated voltage(V)

P: 額定功率 Rated power(W)

R: 標稱阻值 Normal resistance(Ω)

型號 Type	阻值範圍 Resistance Range	電阻溫度系數 T.C.R (ppm/°C)		
		標稱阻值允許偏差 Resistance Tolerance		
		±1%	±5%	±10%
0402	39KΩ < R ≤ 1MΩ	±100	±100	±100
	1.02MΩ < R ≤ 20MΩ	±200	±200	±200
	22MΩ < R ≤ 100MΩ	±400	±400	±400
0603	25KΩ < R ≤ 10MΩ	±100	±100	±100
	10MΩ < R ≤ 100MΩ	±250	±250	±250
0805	180KΩ < R ≤ 10MΩ	±100	±100	±100
	10MΩ < R ≤ 100MΩ	±250	±250	±250
1206	160KΩ < R ≤ 10MΩ	±100	±100	±100
	10MΩ < R ≤ 100MΩ	±250	±250	±250
1210	120KΩ < R ≤ 10MΩ	±100	±100	±100
	10MΩ < R ≤ 100MΩ	±250	±250	±250
2010	54KΩ < R ≤ 10MΩ	±100	±100	±100
	10MΩ < R ≤ 100MΩ	±250	±250	±250
2512	40KΩ < R ≤ 10MΩ	±100	±100	±100
	10MΩ < R ≤ 100MΩ	±250	±250	±250

## 厚膜高壓片式固定電阻器

HIGH VOLTAGE THICK FILM CHIP FIXED RESISTOR

### • 特性 Characteristics

項目 Item	標準 Specifications	測試方法 (IEC60115-1) Test Methods (IEC60115-1)
可焊性 Solderability	可焊面積 ≥ 95% 95% Cover Min	IEC 60115-1 4.17 245°C ± 5°C 錫槽, 保持3s ± 0.3s Lead-free solder bath at 245°C ± 5°C for 3s ± 0.3s
耐焊接熱 Resistance to Soldering Heat	無可見損傷 No mechanical damage $\Delta R \leq \pm(1.0\%R + 0.05\Omega)$	IEC 60115-1 4.18 270°C ± 5°C 錫槽, 保持10s ± 1s Lead-free solder bath at 270°C ± 5°C for 10s ± 1s
基板彎曲試驗 Substrate Bending Test	無可見損傷 No mechanical damage $\Delta R \leq \pm(1.0\%R + 0.05\Omega)$	IEC 60115-1 4.33 彎曲距離(Bending distance): 0603、0805:5mm ;1206、1210: 4mm; 2010、2512: 2mm 保持時間(Duration): 60s ± 5s
剪切力試驗 Shear Test	外觀無可見損傷 No mechanical damage	IEC 60115-1 4.32 施加力(Applying force): 0603: 5N;0805: 9N;1206、1210: 25N; 2010、2512: 45N. 保持時間(Duration): 10s ± 1s.
電阻溫度係數 T.C.R	在規定值內 Within specified T.C.R	IEC 60115-1 4.8 +20°C/-55°C/+20°C/+125°C/+20°C
溫度快速變化 Rapid Change of Temperature	無可見損傷 No mechanical damage $\Delta R \leq \pm(1.0\%R + 0.05\Omega)$	IEC 60115-1 4.19 0603、0805、1206、1210、2010、2512: -55°C(30分鐘) ~ 常溫(5分鐘) ~ 155°C(30分鐘), 300個循環。 0603、0805、1206、1210、2010、2512: -55°C(30min) ~ normal temperature(5min) ~ 155°C(30min), 300 cycles.
短時間過負載 Short Time Overload	無可見損傷 No mechanical damage $\Delta R \leq \pm(5.0\%R + 0.05\Omega)$	IEC 60115-1 4.13 2.5倍額定電壓或最大過負荷電壓(取較小值), 持續5秒。 2.5 times rated voltage or max. overload voltage whichever is lower for 5s.
穩態濕熱 Damp Heat Steady State	無可見損傷 No mechanical damage $\Delta R \leq \pm(3.0\%R + 0.05\Omega)$	IEC 60115-1 4.24 40°C ± 2°C, 93% ± 3%RH, 額定電壓或元件極限電壓(取較小者) 通1.5小時, 斷0.5小時, 持續1000小時。 Resistor should be exposed at 40°C ± 2°C 93% ± 3%RH, and apply rated voltage or limiting element voltage, whichever is lower, for 1.5h on, 0.5h off for 1000h.
70°C 耐久性 Endurance at 70°C	無可見損傷 No mechanical damage $\Delta R \leq \pm(3.0\%R + 0.05\Omega)$	IEC 60115-1 4.25.1 70°C ± 2°C, 1000小時, 額定電壓或元件極限電壓(取較小值), 通1.5小時/斷 0.5小時。 70°C ± 2°C, 1000h, rated voltage or limiting element voltage whichever is lower for 1.5h ON/0.5h OFF.
上限類別溫度耐久性 Endurance at Upper Category Temperature	無可見損傷 No mechanical damage $\Delta R \leq \pm(2.0\%R + 0.05\Omega)$	IEC 60115-1 4.25.3 0603、0805、1206、1210、2010、2512: 155°C ± 2°C, 1000h.
絕緣電阻 Insulation Resistance	1000MΩ Min	IEC 60115-1 4.6 在電極與基片間施加100V ± 15V直流電壓, 保持1分鐘, 然後測絕緣電阻值。 Apply DC 100V ± 15V between substrate and terminations for 1min, then check insulation resistance.
耐溶劑 Component Solvent Resistance	無可見損傷 No mechanical damage $\Delta R \leq \pm(1.0\%R + 0.05\Omega)$	IEC 60115-1 4.29 異丙醇(IPA), 23°C ± 5°C, 浸10小時。 Iso-propyl alcohol (IPA), 23°C ± 5°C, 10h.

### • 包裝 Packaging

包裝方式見附錄 Packaging can refer to the Appendix.

## 附錄 Appendix

### ■ 推薦焊盤尺寸 Recommend Solder Pad Size

- 片式固定電阻器 Chip fixed resistor

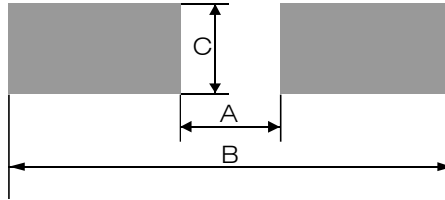

單位 unit: mm

厚膜電阻及薄膜電阻 Thick Film Resistor and Thin Film Resistor			
型號 Type	A	B	C
01005	0.17	0.60	0.22
0201	0.23	0.84	0.38
0402	0.45	1.45	0.60
0603	0.80	2.50	0.95
0805	1.05	3.25	1.40
1206	1.90	4.50	1.75
1210	2.00	4.60	2.70
2010	3.50	6.50	2.70
2512	4.80	7.80	3.40
2512 (2W)	2.70	7.80	3.60

單位 unit: mm

合金片式固定電阻 Metal Foil Resistor				
型號 Type	阻值 (mΩ)	A	B	C
0603	R003~R004	0.4	2.8	1.0
	R005~R030	0.6		
0805	R003~R004	0.5	3.2	1.4
	R005~R047	0.8		
1206	R003~R004	0.8	4.4	1.8
	R005~R068	1.8		
2010	R003~R009	1.6	6.3	2.9
	R010~R100	2.7		
2512	R002~R004	1.0	8.0	3.4
	R005~R200	3.8		

- 厚膜片式網絡電阻器 Thick film chip network resistor

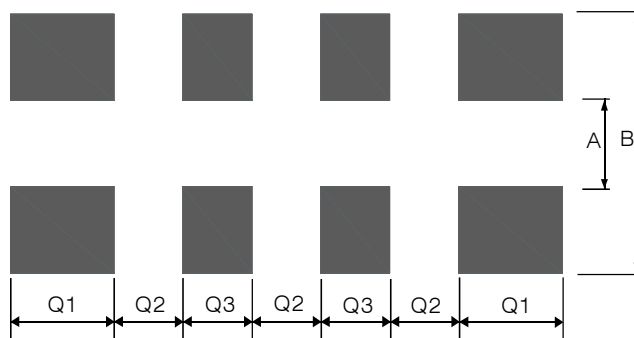

RCMY08 / RCMT08 / RCML08

單位 unit: mm

型號 Type	A	B	Q1	Q2	Q3
RCMY08	0.30	0.90	0.20	0.20	0.20
RCMT08	0.38	1.60	0.40	0.20	0.30
RCML08	0.80	2.70	0.60	0.40	0.40

## ■ 包装 Packaging

### ● 紙帶編帶 Paper Taping

適用於01005、0201、0402、RCMY08、RCMT08；

For 01005、0201、0402、RCMY08、RCMT08；

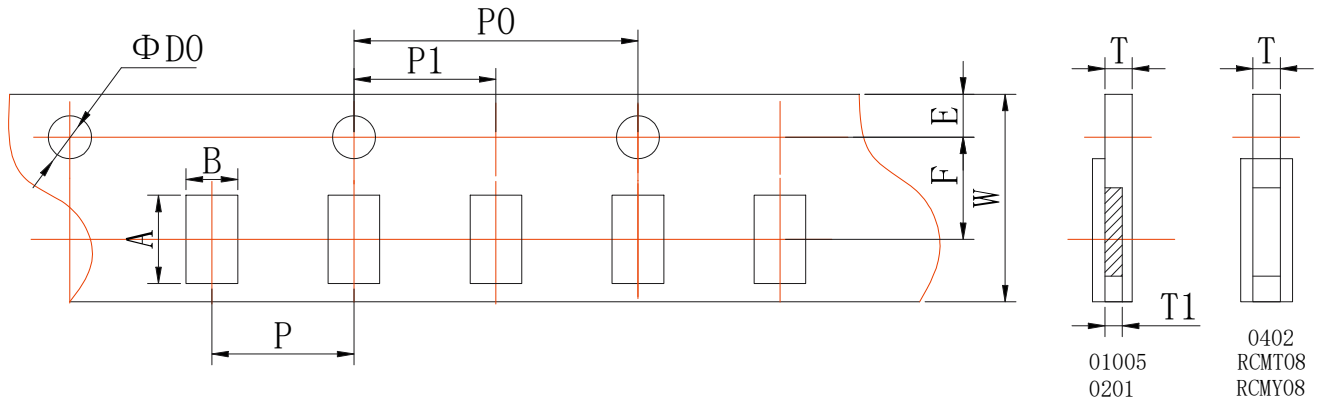

單位 unit: mm

型號 Type	A	B	W	F	E
01005	0.45±0.02	0.25±0.02	8.00±0.02	3.50±0.05	1.75±0.05
0201	0.70±0.10	0.40±0.10	8.00±0.20	3.50±0.05	1.75±0.10
0402	1.20±0.10	0.70±0.10	8.00±0.20	3.50±0.05	1.75±0.10
RCMY08	1.57±0.05	0.77±0.05	8.00±0.20	3.50±0.05	1.75±0.10
RCMT08	2.20±0.10	1.20±0.10	8.00±0.20	3.50±0.05	1.75±0.10

單位 unit: mm

型號 Type	P	P0	P1	ΦD0	T1	T
01005	2.00±0.05	4.00±0.10	2.00±0.05	1.55±0.02	0.17±0.02	0.31±0.02
0201	2.00±0.05	4.00±0.10	2.00±0.05	1.50±0.10	0.28±0.04	0.42±0.05
0402	2.00±0.05	4.00±0.10	2.00±0.05	1.50±0.10	/	0.42±0.05
RCMY08	2.00±0.05	4.00±0.10	2.00±0.05	1.50±0.10	/	0.60±0.10
RCMT08	2.00±0.10	4.00±0.10	2.00±0.05	1.50±0.10	/	0.60±0.10

適用於0603、0805、1206、1210、RCML08；

For 0603、0805、1206、1210、RCML08；

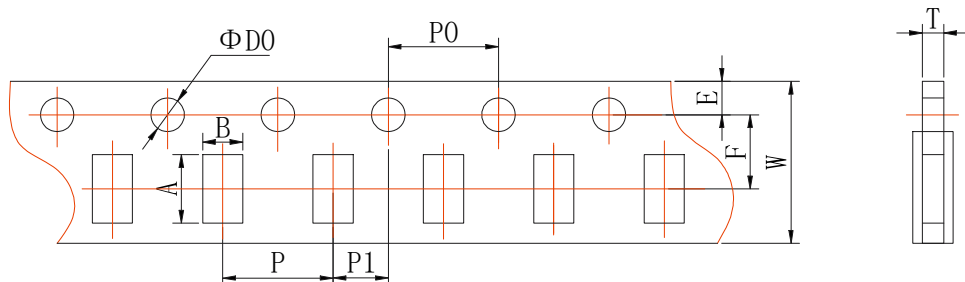

# 片式電阻包裝方式及注意事項

## PACKAGING AND PRECAUTION OF CHIP RESISTOR

單位 unit: mm

型號 Type	A	B	W	F	E
0603	$1.85 \pm 0.10$	$1.10 \pm 0.10$	$8.00 \pm 0.20$	$3.50 \pm 0.05$	$1.75 \pm 0.10$
0805	$2.35 \pm 0.10$	$1.65 \pm 0.10$	$8.00 \pm 0.20$	$3.50 \pm 0.05$	$1.75 \pm 0.10$
1206	$3.50 \pm 0.20$	$1.90 \pm 0.20$	$8.00 \pm 0.20$	$3.50 \pm 0.05$	$1.75 \pm 0.10$
1210	$3.50 \pm 0.20$	$2.80 \pm 0.20$	$8.00 \pm 0.20$	$3.50 \pm 0.05$	$1.75 \pm 0.10$
RCML08	$3.50 \pm 0.20$	$1.90 \pm 0.20$	$8.00 \pm 0.20$	$3.50 \pm 0.05$	$1.75 \pm 0.10$

單位 unit: mm

型號 Type	P	P0	P1	$\Phi D0$	T	
					厚膜電阻及薄膜電阻 Thick Film Resistor and Thin Film Resistor	合金片式固定電阻 Metal Foil Resistor
0603	$4.00 \pm 0.10$	$4.00 \pm 0.10$	$2.00 \pm 0.05$	$1.50 \pm 0.10$	$0.60 \pm 0.10$	$0.75 \pm 0.10$
0805	$4.00 \pm 0.10$	$4.00 \pm 0.10$	$2.00 \pm 0.05$	$1.50 \pm 0.10$	$0.75 \pm 0.10$	$0.95 \pm 0.10$
1206	$4.00 \pm 0.10$	$4.00 \pm 0.10$	$2.00 \pm 0.05$	$1.50 \pm 0.10$	$0.75 \pm 0.10$	$0.95 \pm 0.10$
1210	$4.00 \pm 0.10$	$4.00 \pm 0.10$	$2.00 \pm 0.05$	$1.50 \pm 0.10$	$0.75 \pm 0.10$	---
RCML08	$4.00 \pm 0.10$	$4.00 \pm 0.10$	$2.00 \pm 0.05$	$1.50 \pm 0.10$	$0.75 \pm 0.10$	---

### ● 塑料帶編帶 Embossed Taping

適用於2010、2512:

For 2010、2512:

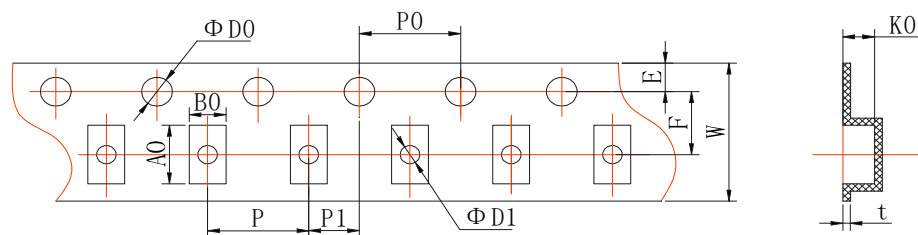

單位 unit: mm

型號 Type	A0	B0	W	F	E	t
2010	$5.50 \pm 0.15$	$2.82 \pm 0.15$	$12.00 \pm 0.10$	$5.50 \pm 0.10$	$1.75 \pm 0.10$	$0.25 \pm 0.05$
2512	$6.78 \pm 0.15$	$3.45 \pm 0.15$	$12.00 \pm 0.10$	$5.50 \pm 0.10$	$1.75 \pm 0.10$	$0.25 \pm 0.05$

單位 unit: mm

型號 Type	P	P0	P1	$\Phi D0$	$\Phi D1$	K0	
						厚膜電阻及薄膜電阻 Thick Film Resistor and Thin Film Resistor	合金片式固定電阻 Metal Foil Resistor
2010	$4.00 \pm 0.10$	$4.00 \pm 0.10$	$2.00 \pm 0.05$	$1.50 \pm 0.10 / -0$	$1.50 \pm 0.10$	$0.84 \pm 0.10$	$0.84 \pm 0.10$
2512	$4.00 \pm 0.10$	$4.00 \pm 0.10$	$2.00 \pm 0.05$	$1.50 \pm 0.10 / -0$	$1.50 \pm 0.10$	$0.81 \pm 0.10$	$1.00 \pm 0.10$

● 卷盤 Reel

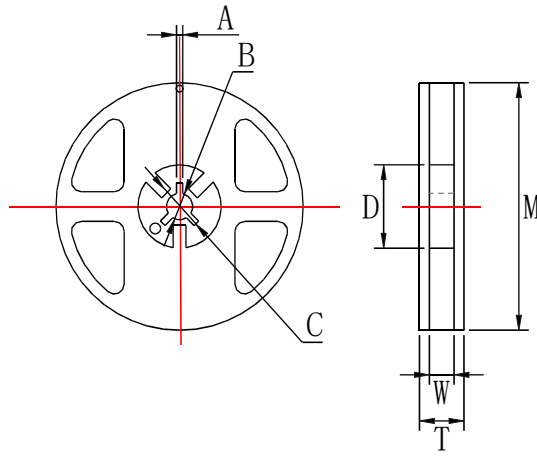

單位 unit: mm

型號 Type	M	W	T	A	B	C	D
01005、0201 0402、0603 0805、1206 1210、RCMY08、 RCMT08、RCML08	178±2.0	9.5±1.0	12.5±1.5	2.0±0.5	13.0±0.5	21.0±0.5	58.0±2.0
2010、2512	178±2.0	13.0±0.5	15.5±1.5	2.0±0.5	13.0±0.5	21.0±0.5	57.0±2.0

● 編帶包裝能力 Taping Ability

面帶拉力 Top tape peel strength

面帶拉力强度未11~70g( 0.1N~0.7N) ， 速度：300mm/min,經下列試驗后不允許有破裂斷帶現象。

Peel strength is 11~70g (0.1N~0.7N),with speed of 300mm/min,and should not have flash and tear after peeling.

測試方法 Test method:

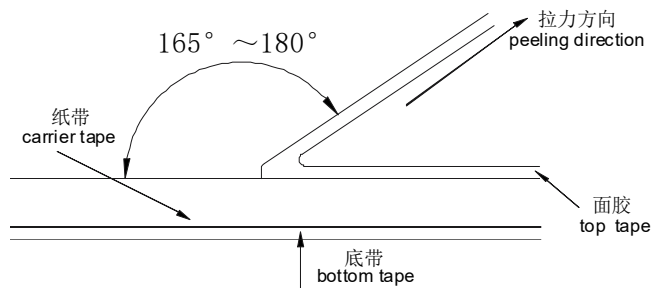

電阻松動自如，無粘面膠帶、底膠帶現象。

Resistor is free, no sticking to top tape and bottom tape.

電阻易從紙帶中取出，且晶片孔無機械損傷。

Resistor is easy to take out from carrier tape and chip hole have no mechanical damage.

# 片式電阻包裝方式及注意事項

## PACKAGING AND PRECAUTION OF CHIP RESISTOR

### ● 包裝數量 Packaging Quantity

包裝方法 Packaging style	編帶 Tape & reel				塑料袋散裝 Case		
型號 Type	01005	0201, 0402 RCMY08, RCMT08	0603, 0805 1206, 1210 RCML08	2010 2512	01005 0201 0402	0603, 0805 1206, RCMY08, RCMT08, RCML08	1210 2010 2512
數量 Quantity(pcs)	20000	10000	5000	4000	≤50000	≤10000	≤4000

### ■ IEC E-24、E-96系列電阻值代碼對照表

#### IEC E-24、E-96 Series Resistance Cross-reference List

#### ● E-24 系列 E-24 series ( $\times 10^n \Omega$ )

(單位 unit: 0.001 $\Omega$ 、0.01 $\Omega$ 、0.1 $\Omega$ 、1 $\Omega$ 、10 $\Omega$ 、100 $\Omega$ 、1k $\Omega$ 、10k $\Omega$ 、100k $\Omega$ 、1M $\Omega$ 、10M $\Omega$ 、100M $\Omega$ 、1000M $\Omega$ )

表一 Table One:

1.0	1.5	2.2	3.3	4.7	6.8
1.1	1.6	2.4	3.6	5.1	7.5
1.2	1.8	2.7	3.9	5.6	8.2
1.3	2.0	3.0	4.3	6.2	9.1

#### ● E-96系列 E-96 series ( $\times 10^n \Omega$ )

(單位unit: 0.001 $\Omega$ 、0.01 $\Omega$ 、0.1 $\Omega$ 、1 $\Omega$ 、10 $\Omega$ 、100 $\Omega$ 、1k $\Omega$ 、10k $\Omega$ 、100k $\Omega$ 、1M $\Omega$ 、10M $\Omega$ 、100M $\Omega$ 、1000M $\Omega$ )

表二 Table Two:

1.00	1.33	1.78	2.37	3.16	4.22	5.62	7.50
1.02	1.37	1.82	2.43	3.24	4.32	5.76	7.68
1.05	1.40	1.87	2.49	3.32	4.42	5.90	7.87
1.07	1.43	1.91	2.55	3.40	4.53	6.04	8.06
1.10	1.47	1.96	2.61	3.48	4.64	6.19	8.25
1.13	1.50	2.00	2.67	3.57	4.75	6.34	8.45
1.15	1.54	2.05	2.74	3.65	4.87	6.49	8.66
1.18	1.58	2.10	2.80	3.74	4.99	6.65	8.87
1.21	1.62	2.15	2.87	3.83	5.11	6.81	9.09
1.24	1.65	2.21	2.94	3.92	5.23	6.98	9.31
1.27	1.69	2.26	3.01	4.02	5.36	7.15	9.53
1.30	1.74	2.32	3.09	4.12	5.49	7.32	9.76



● E-96系列0603型號《乘數代碼對照表》及《電阻值代碼對照表》

E-96 series(0603)《multiplied Cross-reference List》and《Resistance Cross-reference List》

表三 Table Three:

乘數multiplied	$\times 10^0$	$\times 10^1$	$\times 10^2$	$\times 10^3$	$\times 10^4$	$\times 10^5$	$\times 10^6$	$\times 10^7$	$\times 10^{-1}$	$\times 10^{-2}$	$\times 10^{-3}$
代碼 code	A	B	C	D	E	F	G	H	X	Y	Z

表四 Table Four:

代號 Code	E-96系列電阻 E-96 resistance	代號 Code	E-96系列電阻 E-96 resistance	代號 Code	E-96系列電阻 E-96 resistance	代號 Code	E-96系列電阻 E-96 resistance
01	100	25	178	49	316	73	562
02	102	26	182	50	324	74	576
03	105	27	187	51	332	75	590
04	107	28	191	52	340	76	604
05	110	29	196	53	348	77	619
06	113	30	200	54	357	78	634
07	115	31	205	55	365	79	649
08	118	32	210	56	374	80	665
09	121	33	215	57	383	81	681
10	124	34	221	58	392	82	698
11	127	35	226	59	402	83	715
12	130	36	232	60	412	84	732
13	133	37	237	61	422	85	750
14	137	38	243	62	432	86	768
15	140	39	249	63	442	87	787
16	143	40	255	64	453	88	806
17	147	41	261	65	464	89	825
18	150	42	267	66	475	90	845
19	154	43	274	67	487	91	866
20	158	44	280	68	499	92	887
21	162	45	287	69	511	93	909
22	165	46	294	70	523	94	931
23	169	47	301	71	536	95	953
24	174	48	309	72	549	96	976

### ■ 厚膜電阻阻值代碼及標記規則

#### Description for Resistance Value Code and Marking of Thick Film Chip Resistor



- 阻值代碼 Resistance Value Code

所有厚膜電阻的阻值代碼與其標記是相對應的。

All the resistance value code of thick film chip resistor is corresponding with the marking .

- 標記 Marking

- \* E-24系列( $\geq 0603$ 、 $\geq \pm 5\%$ ): 採用三位數字表示, 前二位表示電阻值有效數字, 第三位表示乘以10的次方數。  
E-24 series: Express resistance value on the glass side with three digits, the first two digits should be significant and the third one denote number of zeros.

例 For example:  

- \* E-24系列 ( $0603$ 、 $\leq \pm 1\%$ ): 在三位數字標記下方增加下橫綫識別。

E-24 series( $0603$ 、 $\leq \pm 1\%$ ): Three digits with one short bar under marking letter.

例 For example: 

- \* E-96系列和E24系列 ( $\geq 0805$ 、 $\leq \pm 1\%$ ):

▲ 採用四位數字表示, 前三位表示電阻值有效數字, 第四位表示乘以10的次方數。

E-96 series & E-24 series ( $\geq 0805$ 、 $\leq \pm 1\%$ ):

Express the resistance value with four digits, the first three digits are significant figures and the fourth denotes the number of zeros.

例 For example: 

- \* E-96系列 ( $0603$ 、 $\leq \pm 1\%$ ):

▲ 採用三位代碼表示, 前二位表示E-96系列阻值代碼, 後一位字母表示乘數代碼(見表三和表四)。

Express the resistance value with three code, the first two digit code denote the resistance of E-96 series, and the third code of letter denote the multiplier



(see the table three and four).

例 For example: 

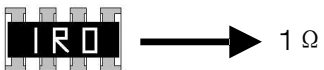
- \* 小數點以“R”表示 The decimal point should be expressed by “R” .

例 For example:  

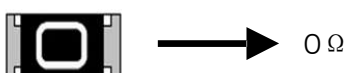
- \* 跨接電阻以“0”表示 The jumper should be expressed by “0”

例 For example:  

- \*  $\leq 0402$ 產品不作標記 For the chip resistor( $\leq 0402$ ), there is no mark on the glass side.

例 For example: 

- \* 非IEC標準系列的電阻值標記表示方法: 一般以最接近IEC E24系列標稱阻值的標記表示方法。

For the resistance which don't belong to IEC serial, use the resistance of IEC serial which is most close to the required resistance of non-IEC serial for replacement.

- \* 客戶對標記有特殊要求時, 則按照協商的結果印刷標記。

To get agreement by both party if there special requirement for the marking.

## ■ 薄膜電阻阻值代碼及標記規則

### Description for Resistance Value Code and Marking of Thin Film Chip Resistor

- 阻值代碼 Resistance Value Code

所有薄膜電阻全尺寸統一採用四位數阻值代碼表示。

All resistance value code of thin film chip resistor used four digits.

例 Example

TD03G4701BT

四位數代號表示，如：4701=4.7KΩ；1R50=1.5Ω

To use four digits code represent resistance value，

例 Example 4701=4.7KΩ；1R50=1.5Ω

- 標記 Marking

\* 當阻值同時存在于E24和E96系列時，優先採用E96系列。

When resistance value belongs to E24 as well as E96 series, we suggest preferentially use E96 series.

例 Example 10K=1002, ≠103

\* ≥0805 產品標記 For the chip resistor (≥0805):

▲ 印刷四位數字代碼；

Express the resistance value with four digits code;

例 Example



\* 0603標記 Marking for 0603 Size Resistor

▲ 0603-E96系列：印刷三位字母代碼；

For resistance value belongs to E96 series, express the resistance value with three digits code.

例 Example



▲ 0603-E24系列：印刷三位數字代碼，

For resistance value belongs to E24 series, express the resistance value with three digits code.

例 Example



\* ▲ 小數點以"R"表示 The decimal point should be expressed by"R".

例 Example



\* ≤0402產品：不作標記 For the chip resistor (≤0402), there is no mark on the glass side.

例 Example



### ■ 電流檢測電阻阻值代碼及標記規則

#### Description for Resistance Value Code and Marking of Current Sensing Thick Film Chip Resistor

##### ● 阻值代碼 Resistance Value Code

所有電流檢測電阻全尺寸統一採用四位數阻值代碼表示。

All resistance value code of current sensing thick film chip resistor used four digits.

例 Example

RBF03MR010FT

四位數代號表示，如：R010=10mΩ；30M1=30.1mΩ

To use four digits code represent resistance value，

例 Example R010=10mΩ；30M1=30.1mΩ

##### ● 標記 Marking

\* E-24和E-96系列(≥0805、≤±5%)：採用四位標記代碼。

For the chip resistor (≥0805、≤±5%)，when resistance value belongs to E24 and E96 series，we suggest preferentially use four digits.

標記代碼 Mark Code	阻值範圍 Resistance Value	示例 Sample
R00X	1mΩ ≤ R ≤ 9mΩ	R005 = 5mΩ
R0XX	10mΩ ≤ R ≤ 99mΩ	R033 = 33mΩ
RXXX	100mΩ ≤ R ≤ 999mΩ	R100 = 100mΩ
XMXX	1mΩ < R < 10mΩ (包含小數點后兩位有效數字) (Contains two significant digits after the decimal point.)	5M10 = 5.1mΩ
XXMX	10mΩ < R < 100mΩ (包含小數點后一位有效數字) (Contains one significant digit after the decimal point.)	30M1 = 30.1mΩ

\* E-24和E-96系列(0603、≤±5%)：採用三位標記代碼。

For the chip resistor (0603、≤±5%)，when resistance value belongs to E24 and E96 series，we suggest preferentially use three digits.

標記代碼 Mark Code	阻值範圍 Resistance Value Range	示例 Sample
V0X	1mΩ ≤ R ≤ 9mΩ	V05 = 5mΩ
VXX	10mΩ ≤ R ≤ 99mΩ	V33 = 33mΩ
RXX	100mΩ ≤ R ≤ 999mΩ	R10 = 100mΩ
VMX	1mΩ < R < 10mΩ (包含小數點后一位有效數字) (Contains one significant digit after the decimal point.)	5M1 = 5.1mΩ

\* ≤0402產品不印刷標記。

For the chip resistor (≤0402)，there is no mark on the glass side.

\* 非IEC標準系列的電阻值標記表示方法：一般以最接近IEC E24系列標稱阻值的標記表示方法。

For the resistance which don't belong to IEC serial，use the resistance of IEC serial which is most close to the required resistance of non-IEC serial for replacement.

\* 客戶對標記有特殊要求時，則按照協商的結果印刷標記。

To get agreement by both party if there special requirement for the marking.

## ■ 片式電阻器使用說明 Chip Resistor Instructions for Use

### ● 本產品在以下特殊環境下應用，性能可能會受到影響：

- 1、在各種類型的液體，包括水、油、化學品、有機溶劑的使用。
- 2、在戶外直接暴露在陽光的地方，或在灰塵多的地方使用。
- 3、在產品暴露的地方，有海風或腐蝕性氣體，包括氯氣、硫化氫、氨氣、二氧化硫、二氧化氮等。
- 4、在產品暴露于靜電或電磁波的地方使用。
- 5、在產生熱量的部件、塑料綫，或其他易燃物品附近使用。
- 6、在用樹脂或其他塗層材料密封產品的情況下使用。
- 7、焊接後使用不潔焊料或使用水或水溶性清洗劑清洗產品。
- 8、片狀電阻器的基材是氧化鋁。由于和安裝基板的熱膨脹系數不同，在反復施加提供熱循環等熱應力時，接合部的焊錫（焊縫部）有時會發生裂紋。如果環境溫度反復發生很大的變動，并且載荷反復進行ON/OFF，則需要注意龜裂的發生。因熱應力而發生的龜裂，取決于所安裝的焊盤的大小、焊錫量、安裝基板的散熱性等，因此在環境溫度有很大的變化或載荷ON/OFF的條件下使用時，請充分注意以進行設計。

### ● Application of the products in a special environment can deteriorate product performance:

- 1、Use in various types of liquid, including water, oils, chemicals, and organic solvents.
- 2、Use outdoors where the products are exposed to direct sunlight, or in dusty places.
- 3、Use in places where the products are exposed to sea winds or corrosive gases, including  $Cl_2$ ,  $H_2S$ ,  $NH_3$ ,  $SO_2$ , and  $No_2$  etc.
- 4、Use in places where the products are exposed to static electricity or electromagnetic waves.
- 5、Use in proximity to heat-producing components, plastic cords, or other flammable items.
- 6、Use involving sealing or coating the products with resin or other coating materials.
- 7、Use involving unclean solder or use of water or water-soluble cleaning agents for cleaning after soldering.
- 8、The substrate of chip resistors is alumina. Cracks may occur at the connection of solder (solder fillet portion) due to the difference of the coefficient of thermal expansion from a mounting board when heat stress like heat cycle, etc. are repeatedly given to them. Care should be taken to the occurrence of the cracks when the change in ambient temperature or ON/OFF of load is repeated. The occurrence of the crack by heat stress may be influenced by the size of a pad, solder volume, heat radiation of mounting board etc., so please pay careful attention to designing when a big change in ambient temperature and conditions for use like ON/OFF of load can be assumed.

### ● 產品使用注意事項

- 1、避免采用超過正常額定功率的功率，超過額定功率的穩態負載條件下可能會對產品性能和可靠性產生負面影響。
- 2、用鑷子拿起產品時要小心，有可能會將保護或電阻體夾碎。
- 3、手動安裝產品時，烙鐵頭勿觸碰產品。
- 4、貯存條件：溫度  $5^{\circ}C \sim 30^{\circ}C$ ，相對濕度30%~70%。  
建議在符合上述儲存條件下六個月內使用。
- 5、用于車載設備、醫療設備、航空設備以及其它涉及人身安全、或可能引起重大損失的設備上時，請務必事先與我公司聯系。這些產品在這類用途中出現故障或失靈可能導致人身事故或嚴重損壞。

### ● Precautions on use of products

- 1、Avoid applying power exceeding normal rated power, exceeding the power rating under steady-state loading condition may negatively affect product performance and reliability.
- 2、Be careful when pick up the products with tweezers. There may be a care that the overcoat and / or the body can be chipped.
- 3、Soldering tip shall not touch the product when install product manually.
- 4、Storage conditions: T:  $5^{\circ}C \sim 30^{\circ}C$ , RH: 30%~70%.  
The products are suggested to be used within six months when received, and the storage condition mentioned above should be followed.
- 5、Contact our sales representatives before you use our products for applications including automotive, medical equipment and aerospace equipment. Malfunction or failure of the products in such applications may cause loss of human life or serious damage.

### ■ 焊接 Soldering

- 推薦的回流焊曲線 Recommended reflow profile
- 推薦的波峰焊曲線 Recommended wave solder profile

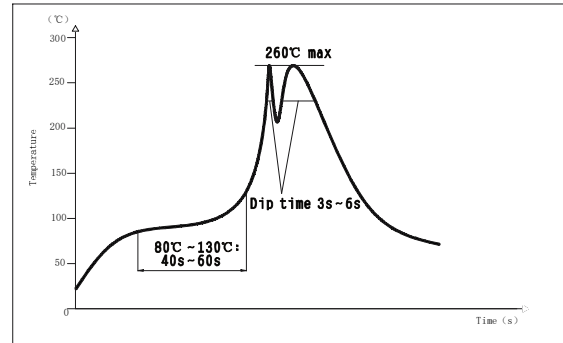
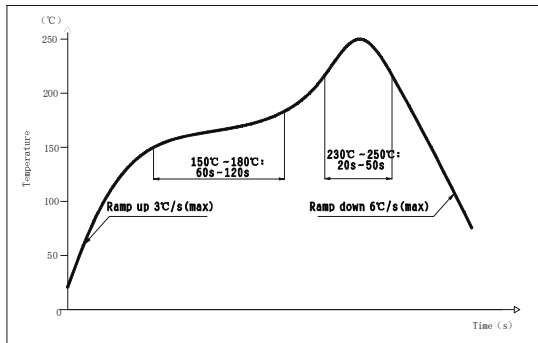

- 推薦的焊膏類型 Recommended solder alloy: 96.5Sn/3.0Ag/0.5Cu

### ■ 修訂履歷 Revision History

版本Version	日期Date	修訂內容 Change Description	修改確認 Checked by
V2020.0	2020-06-23	- 原版 The original version.	吳曉玲 Xiaoling Wu
V2020.1.0	2021-02-24	- 刪除 E-24系列 客戶特殊要求標記說明 Delete marking instructions for special requirements of customers	杜建業 Jianye Du

注：上述所提供之內容為產品規格說明。在產品未變更時，風華保有修改此內容不另行通知之所有權利，任何產品變更將會以PCN通知客戶。

Remark: Information provided above is intended to indicate product specifications only. Fenghua reserves all the rights for revising this content without further notification, as long as products are unchanged. Any product change will be announced by PCN.

## X-ON Electronics

Largest Supplier of Electrical and Electronic Components

*Click to view similar products for* [Thick Film Resistors - SMD category:](#)

*Click to view products by* [Fenghua Advanced manufacturer:](#)

Other Similar products are found below :

[CR-05FL7--150R](#) [CR-05FL7--698K](#) [CR-12FP4--324R](#) [CR-12JP4--680R](#) [M55342K06B10D0RS6](#) [M55342K06B14E0RS6](#)  
[M55342K06B1E78RS3](#) [M55342K06B24E9RS6](#) [M55342K06B6E19RWL](#) [M55342K06B6E81RS3](#) [M55342M05B200DRWB](#)  
[M55342M06B4K70MS3](#) [MC0603-511-JTW](#) [742C083750JTR](#) [MCR01MZPF1202](#) [MCR01MZPF1601](#) [MCR01MZPF1800](#)  
[MCR01MZPF6201](#) [MCR01MZPF9102](#) [MCR01MZPJ113](#) [MCR01MZPJ121](#) [MCR01MZPJ125](#) [MCR01MZPJ751](#) [MCR03EZHZ103](#)  
[MCR03EZPF2004](#) [MCR03EZPJ270](#) [MCR03EZPJ821](#) [MCR10EZPF1102](#) [MCR10EZPF2700](#) [MCR18EZPJ330](#) [RC1005F1152CS](#)  
[RC1005F1182CS](#) [RC1005F1372CS](#) [RC1005F183CS](#) [RC1005F1911CS](#) [RC1005F1912CS](#) [RC1005F203CS](#) [RC1005F2052CS](#)  
[RC1005F241CS](#) [RC1005F2431CS](#) [RC1005F3011CS](#) [RC1005F303CS](#) [RC1005F4321CS](#) [RC1005F4642CS](#) [RC1005F471CS](#)  
[RC1005F4751CS](#) [RC1005F5621CS](#) [RC1005F6041CS](#) [RC1005J106CS](#) [RC1005J121CS](#)