



# 承 认 书

## APPROVAL SHEET

客户名称:

CUSTOMER

品 名:

PARTNAME

薄膜片式固定电阻器 – T 系列

Thin Film Chip Fixed Resistor – T Series

规 格:

- T\*02  \* \* \*
- T\*03  \* \* \*
- T\*05  \* \* \*
- T\*06  \* \* \*
- T\*1210  \* \* \*
- T\*10  \* \* \*
- T\*12  \* \* \*

SPECIFICATION

版 本 号:

VERSION

T-2.0

日 期:

DATE

制 造			客 户		
APPROVAL			APPROVAL		
拟制	审核	确认	检验	审核	批准



序号 No	目 录 TABLE OF CONTENTS
1.0	概述 Summary
2.0	结构及尺寸 Structure and Dimension
3.0	型号规格表示办法 How To Order
4.0	电气性能 Performance Specification
5.0	特性 Characteristics
6.0	包装 Package
7.0	环保情况说明 Environmental Protection Statement
8.0	推荐使用的焊接曲线 Recommended soldering profile
9.0	使用说明 Chip Resistor Instructions for Use
10.0	使用注意事项 Precautions for Use



薄膜片式固定电阻器 Thin Film Chip Fixed Resistor

版本号 Version No: T-2.0

T Series

1.0 概述 Summary

薄膜片式电阻主要生产的型号包括：0201、0402、0603、0805、1206、1210、2010、2512。其特点是：  
The sizes for thin film chip resistor are including : 0201、0402、0603、0805、1206、1210、2010、2512, and the features are as below:

◆特性 Feature

- 低温度系数 ( $\pm 5\text{ppm} / ^\circ\text{C}$ )、低噪音; Low TCR ( $\pm 5\text{ppm} / ^\circ\text{C}$ )、and low noise;
- 高精度 (低至  $\pm 0.05\%$ ) ; High accuracy ( $\pm 0.05\%$ ) ;
- 适应再流焊与波峰焊; Suit for re-flow and wave soldering;
- 良好的耐湿性, 高可靠性 Excellent moisture resistance, corrosion resistance;
- 符合 ROHS 指令要求。 Compliant with ROHS directive;
- 符合无卤素要求 Compliant with halogen free requirement.

◆应用领域 Application

医学仪器、测试/测量设备、打印设备、自动设备控制器、转换器、通讯设备、手机等。  
Medical Equipment、Test/Measurement Equipment、Printer Equipment、Automatic Equipment Controller、Converters、Communication Device、Mobile phone etc.

2.0 结构及尺寸 Structure and Dimension

2.1 结构 Structure

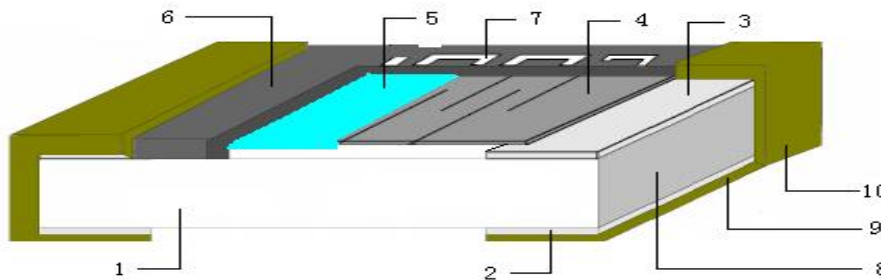

1、陶瓷基片 Ceramic Substrate	6、保护层 Protective Coating
2、背电极 Bottom Electrode	7、标 记 Marking
3、面电极 Top Electrode	8、端电极 Inner Termination
4、电阻体 Resistive Layer	9、中间电极 Middle Termination
5、钝化层 Passivation	10、外部电极 Outer Termination



薄膜片式固定电阻器 Thin Film Chip Fixed Resistor	版本号 Version No: T-2.0
T Series	

### 2.2 尺寸 Dimension

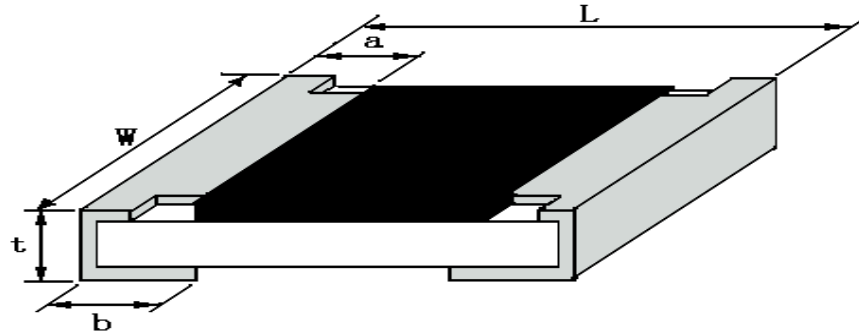

型号 Type	L (mm)	W (mm)	t (mm)	a (mm)	b (mm)
0201	0.60±0.05	0.30±0.05	0.23±0.05	0.10±0.05	0.15±0.05
0402	1.00±0.10	0.50±0.10	0.30±0.10	0.20±0.10	0.25±0.10
0603	1.60±0.15	0.80±0.15	0.40±0.10	0.30±0.20	0.30±0.20
0805	2.00±0.20	1.25±0.15	0.50±0.10	0.30±0.20	0.40±0.20
1206	3.20±0.20	1.60±0.15	0.55±0.10	0.30±0.20	0.50±0.20
1210	3.20±0.20	2.50±0.20	0.55±0.10	0.30±0.20	0.50±0.20
2010	5.00±0.20	2.50±0.20	0.55±0.10	0.60±0.20	0.60±0.20
2512	6.40±0.20	3.20±0.20	0.55±0.10	0.60±0.20	0.60±0.20

### 2.3 产品外观 Appearance

#### 2.3.1 电阻器表面保护膜覆盖完好且难以脱落,表面平整;

The surface of resistor is covered with protective coating which hard to fade, and the surface of coating should be avoided unevenness.

#### 2.3.2 电阻器端电极覆盖均匀、镀层较难脱落、而且平整、无开裂、针孔、变色;

The terminal of resistor is covered equable, the plating is hard to fade, and should be avoided unevenness, flaw, pinhole and discoloration.

#### 2.3.3 电阻器芯片无裂痕、标记可辨。

The resistor body is crack-free, and with a clear marking



薄膜片式固定电阻器 Thin Film Chip Fixed Resistor	版本号 Version No: T-2.0
T Series	

### 3.0 型号规格表示办法 How To Order

功率代号 Power Rating Series	
代号 Code	额定功率代号 Power rating
A	1/32W
C	1/16W
D	1/10W
E	1/8W
F	1/4W
G	1/2W
R	1/3W

电阻温度系数 Resistance Temperature Coefficient	
代号 Code	T.C.R (ppm/°C)
D	±5
E	±10
F	±15
G	±25
H	±50

包装方式代号 Packing Style Code	
代号 Code	包装方法 Packaging Style
T	编带包装 Tape & Reel
C	塑料袋散装 Case

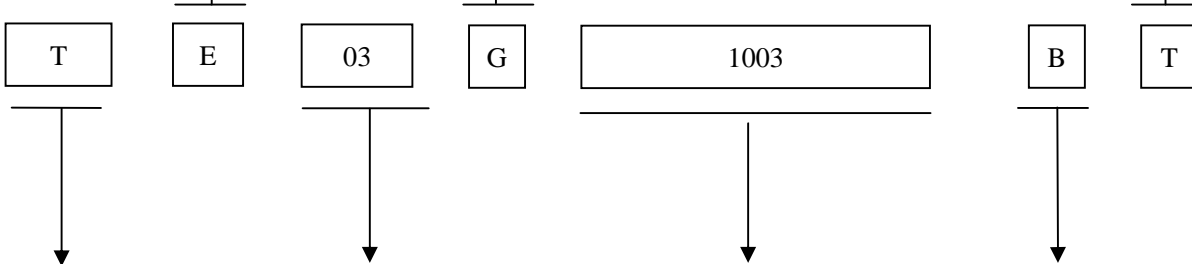

产品代号 Product Code
薄膜片式固定电阻 Thin Film Chip Fixed Resistor (T Series)

代号 Code	型号 Type
01	0201
02	0402
03	0603
05	0805
06	1206
1210	1210
10	2010
12	2512

电阻值代号 Resistance Value Code
四位数：前三位表示有效数字，第四位表示有效数字后零的个数。 Four digits: The first three digits are significant figures and the four one denotes number of zeros. 小数点用 R 表示。Decimal point should be expressed by "R". 例如 Example : 4701=4.7KΩ (E-24) 1003=100KΩ (E-96) 5R10=5.1Ω

电阻值误差精度代号 Resistance Tolerance Code	
A	±0.05%
B	±0.1%
C	±0.25%
D	±0.5%
F	±1%



薄膜片式固定电阻器 Thin Film Chip Fixed Resistor	版本号 Version of: 2.0
T Series	

3.1 标记表示方法 The Explanation For The Resistance Value Marking

IEC E-24、E-96 系列阻值对照表

IEC E-24、E-96 Series Resistance Cross-reference List

E-24 系列 ( E-24 series)

( $\times 10^n \Omega$ )

(单位 unit: 1 $\Omega$ 、10 $\Omega$ 、100 $\Omega$ 、1K $\Omega$ 、10K $\Omega$ 、100K $\Omega$ 、1M $\Omega$ 、10M $\Omega$ )

表 1 Table one

1.0	1.5	2.2	3.3	4.7	6.8
1.1	1.6	2.4	3.6	5.1	7.5
1.2	1.8	2.7	3.9	5.6	8.2
1.3	2.0	3.0	4.3	6.2	9.1

E-96 系列 (E-96 series)

( $\times 10^n \Omega$ )

(单位: 1 $\Omega$ 、10 $\Omega$ 、100 $\Omega$ 、1K $\Omega$ 、10K $\Omega$ 、100K $\Omega$ 、1M $\Omega$ 、10M $\Omega$ )

表 2 Table two

1.00	1.33	1.78	2.37	3.16	4.22	5.62	7.50
1.02	1.37	1.82	2.43	3.24	4.32	5.76	7.68
1.05	1.40	1.87	2.49	3.32	4.42	5.90	7.87
1.07	1.43	1.91	2.55	3.40	4.53	6.04	8.06
1.10	1.47	1.96	2.61	3.48	4.64	6.19	8.25
1.13	1.50	2.00	2.67	3.57	4.75	6.34	8.45
1.15	1.54	2.05	2.74	3.65	4.87	6.49	8.66
1.18	1.58	2.10	2.80	3.74	4.99	6.65	8.87
1.21	1.62	2.15	2.87	3.83	5.11	6.81	9.09
1.24	1.65	2.21	2.94	3.92	5.23	6.98	9.31
1.27	1.69	2.26	3.01	4.02	5.36	7.15	9.53
1.30	1.74	2.32	3.09	4.12	5.49	7.32	9.76



薄膜片式固定电阻器 Thin Film Chip Fixed Resistor

版本号 Version No: T-2.0

T Series

3.2 电阻值代码及标记规则

Description for Resistance Value Code and Marking of Thin Film Chip Resistor

■ 阻值代码 Resistance Value Code

所有薄膜电阻包括 0201、0402、0603、0805、1206、1210、2010、2512 统一采用四位数字阻值代码表示。  
All resistance value code of thin film chip resistor, including 0201、0402、0603、0805、1206、1210、2010、2512 size used four digits.

例 Example: TD03G 4701 BT

四位数字代号表示, 如: 4701=4.7KΩ 5R10=5.1Ω。

■ 标记 Marking

当阻值同时存在于 E24 和 E96 系列时, 优先采用 E96 系列。

When resistance value belongs to E24 as well as E96 series, we suggest preferentially use E96 series.

例 Example: 10K=1002, ≠103

▲ 0805、1206、1210、2010、2512 标记 Marking for 0805、1206、1210、2010、2512 Size Resistor

0805、1206、1210、2010、2512 印刷四位数字代码;

For 0805、1206、1210、2010、2512 size resistor, express the resistance value with four digits code;

例 Example:



▲ 0603 标记 Marking for 0603 Size Resistor

0603-E96 系列:

0603 印刷三位代码表示, 前二位表示 E-96 系列阻值代码, 后一位字母表示乘数代码 (见表 3 和表 4)。

For the specification of 0603, expressing the resistance value with three digits. The first two digits code denote the resistance of E-96 series, and the third code of letter denote the multiplier (refer to table 3 and table 4).

例 Example:



▲ 0603-E24 系列: 印刷三位数字代码,

For resistance value belongs to E24 series, express the resistance value with three digits code.

例 Example:



▲ 0201、0402: 不作标记 For the dimension type of 0201、0402 there is no mark on the glass side.

例 Example:



■ 客户对标记有特殊要求时, 则按照协商的结果印刷标记。

To get agreement by both parties if there is special requirement for the marking.



薄膜片式固定电阻器 Thin Film Chip Fixed Resistor	版本号 Version No: T-2.0
T Series	

表3 Table Three: E-96 系列阻值代码 E-96 Series Resistance Value Code

代号 Code	E-96 阻值 The resistance of E-96 series	代号 Code	E-96 阻值 The resistance of E-96 series	代号 Code	E-96 阻值 The resistance of E-96 series	代号 Code	E-96 阻值 The resistance of E-96 series
01	100	25	178	49	316	73	562
02	102	26	182	50	324	74	576
03	105	27	187	51	332	75	590
04	107	28	191	52	340	76	604
05	110	29	196	53	348	77	619
06	113	30	200	54	357	78	634
07	115	31	205	55	365	79	649
08	118	32	210	56	374	80	665
09	121	33	215	57	383	81	681
10	124	34	221	58	392	82	698
11	127	35	226	59	402	83	715
12	130	36	232	60	412	84	732
13	133	37	237	61	422	85	750
14	137	38	243	62	432	86	768
15	140	39	249	63	442	87	787
16	143	40	255	64	453	88	806
17	147	41	261	65	464	89	825
18	150	42	267	66	475	90	845
19	154	43	274	67	487	91	866
20	158	44	280	68	499	92	887
21	162	45	287	69	511	93	909
22	165	46	294	70	523	94	931
23	169	47	301	71	536	95	953
24	174	48	309	72	549	96	976

表4 Table Four: 乘数代码 Multiplied Code

乘数次方 Multiplier	$\times 10^0$	$\times 10^1$	$\times 10^2$	$\times 10^3$	$\times 10^4$	$\times 10^5$	$\times 10^6$	$\times 10^7$	$\times 10^{-1}$	$\times 10^{-2}$	$\times 10^{-3}$
代 码 Code	A	B	C	D	E	F	G	H	X	Y	Z





薄膜片式固定电阻器 Thin Film Chip Fixed Resistor r					版本号 Version No: T-2.0				
T Series									
4.0 电气性能 Performance Specification									
◆ 额定值 Ratings									
项目 Item  型号 Type	70℃下 额定功率 Rated Power at 70℃ (W)	元件极限 电压 Limiting Element Voltage (V)	最大过负 荷电压 Max .Over load Voltage (V)	阻值范围 Resistance Range					温度系数 TCR (ppm/℃)
				±0.05%	±0.1%	±0.25%	±0.5%	±1%	
0201	1/32W	15V	30V	----			49.9Ω ~ 4.99KΩ	±25	
				----			49.9Ω ~ 33KΩ	±50	
0402	1/16W	25V	50V	24.9Ω ~ 5KΩ				±5	
				10Ω ~ 12KΩ				±10	
				10Ω ~ 100KΩ				±15 ±25 ±50	
0603	1/16W 1/10W	50V	100V	24.9Ω ~ 15KΩ				±5	
				10Ω ~ 200KΩ				±10 ±15	
				10Ω ~ 332KΩ		1Ω ~ 332KΩ		±25 ±50	
0805	1/10W 1/8W	100V	200V	24.9Ω ~ 30KΩ				±5	
				4.7Ω ~ 330KΩ				±10 ±15	
				4.7Ω ~ 1MΩ		1Ω ~ 1MΩ		±25 ±50	
1206	1/8W 1/4W	150V	300V	24.9Ω ~ 50KΩ				±5	
				4.7Ω ~ 470KΩ				±10 ±15	
				4.7Ω ~ 1MΩ		1Ω ~ 1MΩ		±25 ±50	
1210 2010	1/4W 1/3W	150V	300V	24.9Ω ~ 50KΩ				±5	
				4.7Ω ~ 470KΩ				±10 ±15	
				4.7Ω ~ 1MΩ		1Ω ~ 1MΩ		±25 ±50	
2512	1/2W	150V	300V	24.9Ω ~ 50KΩ				±5	
				4.7Ω ~ 470KΩ				±10 ±15	
				4.7Ω ~ 1MΩ		1Ω ~ 1MΩ		±25 ±50	

1、 $E = \sqrt{P \times R}$  或元件极限电压两者中的较小值  
 $E = \sqrt{P \times R}$  or Limiting element voltage whichever is lower  
E: 额定电压 Rated Voltage (V) R: 标称阻值 Normal Resistance (Ω) P: 额定功耗 Rated Power (W)

2、使用温度: -55℃ ~ 155℃  
Operating temperature range: -55℃ ~ 155℃



薄膜片式固定电阻器 Thin Film Chip Fixed Resistor	版本号 Version No: T-2.0
T Series	

◆ 负荷下降曲线 Power Derating Curve

使用温度范围 Operating Temperature Range: -55°C~155°C

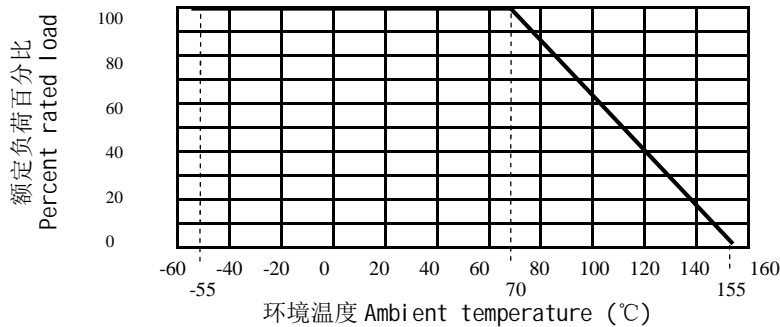

5.0 特性 Characteristics

试验项目 Test Item	标准 Specification		试验方法 Test Method (IEC 60115-1)
	常规功率系列 Normal power rating	提升功率系列 High power rating	
电阻温度系数 T.C.R	在规定值内 within specified T.C.R		IEC 60115-1 4.8 +25°C/-55°C/+25°C/+125°C/+25°C
绝缘电阻 Insulation Resistance	≥1000MΩ		IEC 60115-1 4.6 在电极与基片间施加 100V±15V 直流电压,保持 1 分钟,然后测绝缘电阻值。 Apply DC 100V between termination and substrate for 1 minute, then check the insulation resistance.
耐电压 Voltage Proof	无击穿或飞弧 No breakdown or flashover		IEC 60115-1 4.7 在电极与基片间以大约 100V/s 的速率施加有效值为最大过负荷电压的交流电压,保持 60s ±5s。 Apply max. overload voltage of AC RMS at a rate of approximately 100V/s between substrate and terminations for 60s±5s.
短时间过负载 Short Time Overload	无可见损伤 No mechanical damage. ΔR ≤ ± (0.2%R + 0.05 Ω)		IEC 60115-1 4.13 2.5 倍额定电压或最大过负载电压(取较小者)保持 5 秒 Apply 2.5 times rated voltage or Max overload voltage, whichever is lower, for 5 seconds.
耐焊接热 Resistance to Soldering Heat	无可见损伤 No mechanical damage. ΔR ≤ ± (0.2%R + 0.05 Ω)		IEC 60115-1 4.18 270°C±5°C 锡槽, 保持 10s±1s Lead-free solder bath at 270°C±5°C for 10s±1s
可焊性 Solder-ability	可焊面积≥95%. The termination coverage should be 95% cover min		IEC 60115-1 4.17 245°C±5°C 锡槽, 保持 3s±0.3s Lead-free solder bath at 245°C±5°C for 3s±0.3s
温度快速变化 Rapid Change of Temperature	无可见损伤 No mechanical damage. ΔR ≤ ± (0.25%R + 0.05 Ω)		IEC 60115-1 4.19 -55°C~155°C 100 个循环 -55°C~155°C 100cycles



薄膜片式固定电阻器 Thin Film Chip Fixed Resistor		版本号 Version No: T-2.0	
T Series			
试验项目 Test Item	标准 Specification		测试方法 Test Method
	常规功率系列 Normal power rating	提升功率系列 High power rating	
70℃耐久性 Endurance at 70℃	无可见损伤 No mechanical damage. $\Delta R \leq \pm (0.2\%R + 0.05 \Omega)$	无可见损伤 No mechanical damage. $\Delta R \leq \pm (0.5\%R + 0.05 \Omega)$	IEC 60115-1 4.25.1 70℃±2℃额定电压或元件极限电压(取较小者)通 1.5 小时,断 0.5 小时,持续 1000 小时。 Resistor should be exposed at 70℃±2℃, and apply rated voltage or limiting element voltage, whichever is lower, for 1.5h on, 0.5h off for 1000h.
稳态湿热 Damp Heat, Steady State	无可见损伤 No mechanical damage. $\Delta R \leq \pm (0.3\%R + 0.05 \Omega)$	无可见损伤 No mechanical damage. $\Delta R \leq \pm (0.5\%R + 0.05 \Omega)$	IEC 60115-1 4.24 40℃±2℃, 93%±3%RH, 额定电压或元件极限电压(取较小者)通 1.5 小时,断 0.5 小时,持续 1000 小时。 Resistor should be exposed at 40℃±2℃ 93%±3%RH, and apply rated voltage or limiting element voltage, whichever is lower, for 1.5h on, 0.5h off for 1000h.
低温负载 Operation at Low Temperature	无可见损伤 No mechanical damage. $\Delta R \leq \pm (0.2\%R + 0.05 \Omega)$	无可见损伤 No mechanical damage. $\Delta R \leq \pm (0.5\%R + 0.05 \Omega)$	IEC 60115-1 4.36 -55℃±5℃, 无负载 1 小时, 额定电压或元件极限电压(取较小值) 45 分钟, 无负载 15 分钟。 -55℃±5℃, 1h without load, rated voltage or limiting element voltage whichever is lower for 45min, 15min without load.
上限类别温度 耐久性 Endurance at Upper Category Temperature	无可见损伤 No mechanical damage. $\Delta R \leq \pm (0.2\%R + 0.05 \Omega)$		IEC 60115-1 4.25.3 155℃±2℃, 96 小时 155℃±2℃, 96 hrs
基板弯曲试验 Substrate Bending Test	无可见损伤 No mechanical damage. $\Delta R \leq \pm (0.2\%R + 0.05 \Omega)$		IEC 60115-1 4.33 弯曲距离(Bending distance): 0201、0402、0603、0805: 5mm; 1206、1210: 4mm; 2010、2512: 2mm 保持时间(Duration): 60s±5s



薄膜片式固定电阻器 Thin Film Chip Fixed Resistor

T Series

版本号 Version No: T-2.0

6.0 包装 Package

6.1 编带包装 Taping

6.1.1 结构尺寸 Dimension And Structure

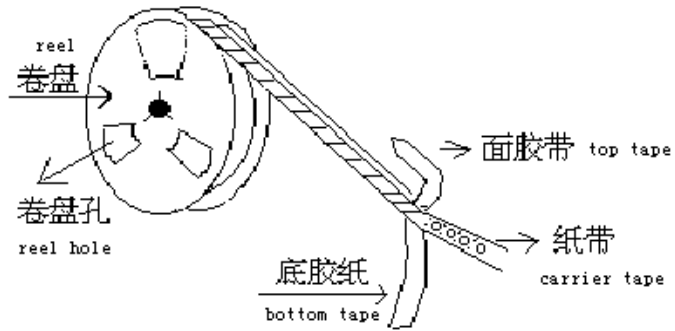

(A) 载带尺寸 Carrier Tape Dimension

■ 纸带编带 Paper Carrier Tape

For 0201、0402 type

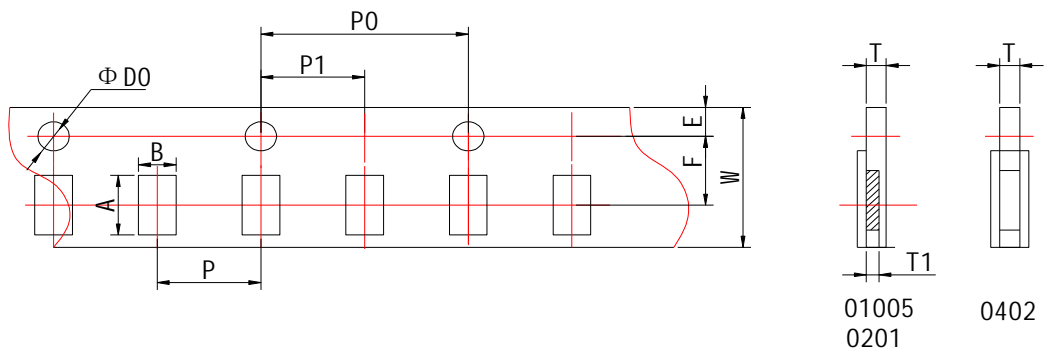

For 0603、0805、1206、1210 type

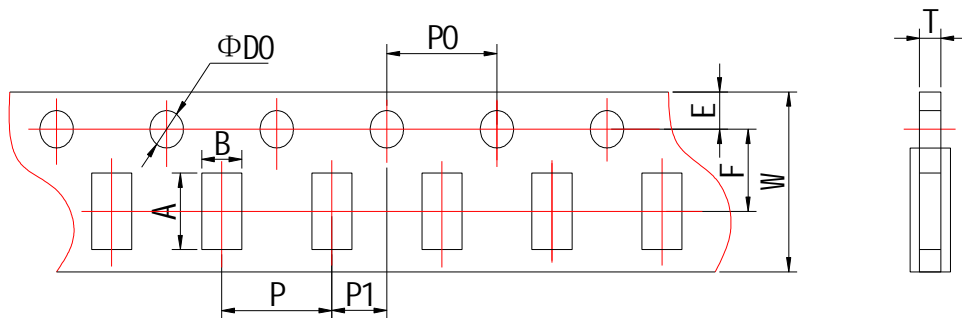



薄膜片式固定电阻器 Thin Film Chip Fixed Resistor	版本号 Version No: T-2.0
T Series	

单位 Unit:mm

型号 Type	A	B	W	F	E
0201	0.70±0.10	0.40±0.10	8.00±0.20	3.50±0.05	1.75±0.10
0402	1.20±0.10	0.70±0.10	8.00±0.20	3.50±0.05	1.75±0.10
0603	1.85±0.10	1.10±0.10	8.00±0.20	3.50±0.05	1.75±0.10
0805	2.35±0.10	1.65±0.10	8.00±0.20	3.50±0.05	1.75±0.10
1206	3.50±0.20	1.90±0.20	8.00±0.20	3.50±0.05	1.75±0.10
1210	3.50±0.20	2.80±0.20	8.00±0.20	3.50±0.05	1.75±0.10

单位 Unit:mm

型号 Type	P	P0	P1	ΦD0	T	
0201	2.00±0.05	4.00±0.10	2.00±0.05	1.50±0.10	T1: 0.28±0.04	T: 0.42±0.05
0402	2.00±0.05	4.00±0.10	2.00±0.05	1.50±0.10	0.42±0.05	
0603	4.00±0.10	4.00±0.10	2.00±0.05	1.50±0.10	0.60±0.10	
0805	4.00±0.10	4.00±0.10	2.00±0.05	1.50±0.10	0.75±0.10	
1206	4.00±0.10	4.00±0.10	2.00±0.05	1.50±0.10	0.75±0.10	
1210	4.00±0.10	4.00±0.10	2.00±0.05	1.50±0.10	0.75±0.10	

备注：0201 型号中 T1 指纸带方孔槽深；T 指纸带厚度。

Remark: For 0201type, T1 refers to the whole depth of paper carrier tape; T refers to the thickness of the paper carrier tape.

■塑料带编带 Embossed taping

适用于 2010、2512: For 2010、2512:

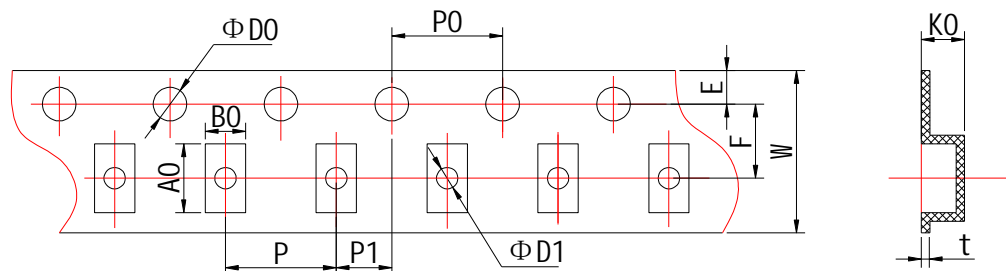



薄膜片式固定电阻器 Thin Film Chip Fixed Resistor						版本号 Version No: T-2.0
T Series						

单位 Unit:mm

型号 Type	A0	B0	W	F	E	t
2010	5.45±0.10	2.77±0.10	12.00±0.10	5.50±0.10	1.75±0.10	0.24±0.05
2512	6.73±0.10	3.40±0.10	12.00±0.10	5.50±0.10	1.75±0.10	0.24±0.05

单位 Unit:mm

型号 Type	P	P0	P1	ΦD0	ΦD1	K0
2010	4.00±0.10	4.00±0.10	2.00±0.05	1.50+0.10/-0	1.50±0.10	0.84±0.10
2512	4.00±0.10	4.00±0.10	2.00±0.05	1.50+0.10/-0	1.50±0.10	0.81±0.10

(B) 卷盘尺寸 Reel Dimension

型号 Type	M	W	T	A	B	C	D
0201 0402 0603 0805 1206 1210	178±2.0	9.5±1.0	12.5±1.5	2.0±0.5	13.0±0.5	21.0±0.5	58.0±2.0
2010 2512	178±2.0	13.0±0.5	15.5±1.5	2.0±0.5	13.0±0.5	21.0±0.5	57.0±2.0

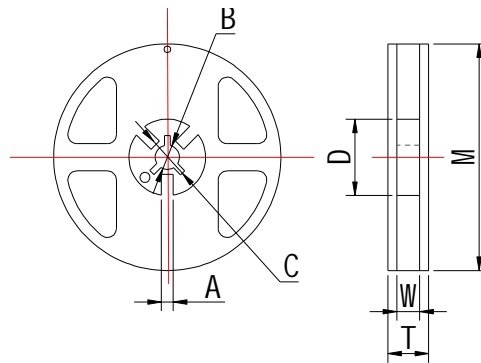

6.1.2 编带包装标准 Taping Specification

(A) 能力 Ability

■面带拉力 top tape peel strength

面带拉力强度为 11~70g(0.1N~0.7N)，速度：300mm/min，经下列试验后不允许有破裂断带现象。  
Peel strength is 11~70g(0.1N~0.7N)，with speed of 300mm/min，and should not have flash and tear after peeling.

测试方法 test method:

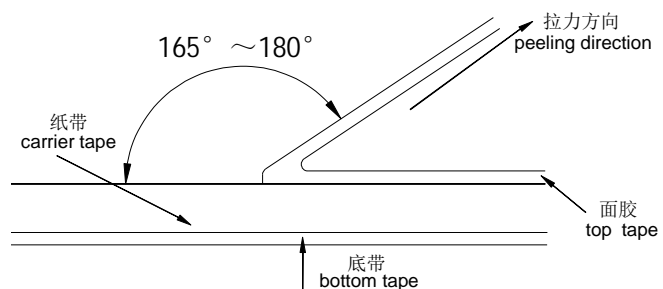



薄膜片式固定电阻器 Thin Film Chip Fixed Resistor	版本号 Version No: T-2.0
T Series	

- 电阻松动自如,无粘面、底胶现象.  
Resistor is free, no sticking to top tape and bottom tape.
- 电阻易从纸带中取出,且芯片孔无机械损伤.  
Resistor is easy to take out from carrier tape and chip hole have no mechanical damage.

(B) 编带包装数量 Quantity In Taping unit: PCS / reel

型号规格 Type	数量 Quantity
0201 0402	10000
0603 0805 1206 1210	5000
2010 2512	4000

(C) 载带说明 Carrier Tape Statement

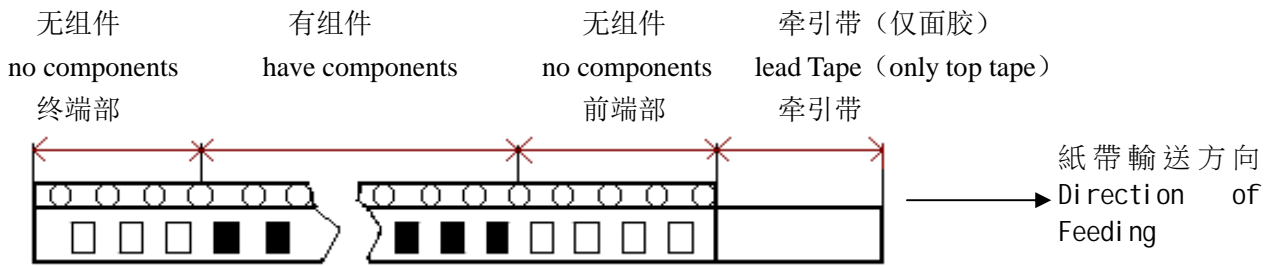

长度 length unit: mm

终端部 terminal	前端部 front	牵引带 lead tape
80~280	350-400	120-140

6.1.3 外包装 Outer Packaging

第一次包装: 数量: 1卷~10卷  
the first package : 1~10 reels

第二次包装: 数量: 最多 25 盒  
the second package: 25 case Max

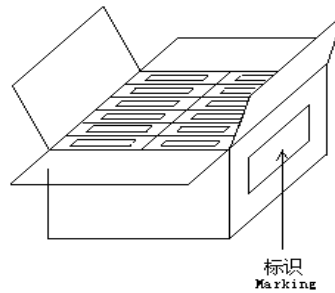
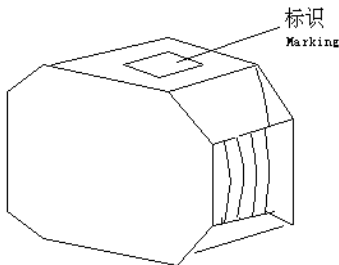

- 当包装数量不能达到最大时,剩余空隙部位采用辅助材料填满.  
When quantity shall not reach the max , the remaining empty space shall be buried with buffer material.
- 当数量为最小时,使用别的方法包装,确保运输过程中无问题是至关重要的.  
When the quantity is a few, alternative packing methods may be used. It is very important to ensure the safety of the products during transportation.



薄膜片式固定电阻器 Thin Film Chip Fixed Resistor	版本号 Version No: T-2.0
T Series	

6.1.4 标签 Label

■卷盘标签 label on the reel

- (1. 客户物料号 customer part No. 2. 客户订单号 customer P/O) 3. 型号规格 Part No  
 4. 数量 quantity 5. 标称阻值 resistance 6. 额定功率 rated power  
 7. 电阻值误差 tolerance 8. 出厂日期 delivery date 9. QC 印章 QC marking  
 10. ROHS marking

■内箱标签 label on inner packaging box

- (1. 客户物料 customer part No. 2. 客户订单号 customer P/O) 3. 型号规格 Part No  
 4. 数量 quantity 5. 标称阻值 resistance 6. 额定功率 rated power  
 7. 电阻值误差 tolerance 8. 出厂日期 delivery date 9. QC 印章 QC marking  
 10. ROHS marking

■外箱标签 label on outer packaging box

1. 客户名称 customer name 2. 合同编号 contract No. 3. 产品名称 product name  
 4. 风华型号规格 part No. 5. 数量 quantity 6. 箱号 case No.  
 7. 制造者名称 maker name 8. QC 印章 QC marking 9. 客户订单号: customer P/O  
 10. 客户订单号: customer P/O 11. 客户物料号: customer part No 12. 出货日期: delivery date  
 13. 装箱清单号: Packing list number 14. 毛重: gross weight 15. 净重: net weight  
 16. 原产地 Country of origin



备注 Remark:

①( )部分可按客户要求而定。

The content with bracket could be designed according to customers' requirement.

①一般情况下，环保产品采用“ROHS”标示。

Usually, the environmental product will be used “ROHS” label.

卷盘标签上的环保标识 Environmental Logo on Reel Label	外箱上的环保标识 Environmental Logo on Outer Box
	





薄膜片式固定电阻器 Thin Film Chip Fixed Resistor

版本号 Version No: T-2.0

T Series

**7.0 环保情况说明 Environmental Protection Statement**

※ 产品符合 ROHS 指令 Compliant with ROHS Directive.

1) 表面处理层（即外部电极）无铅（Pb≤100ppm）

The termination of the chip resistor is lead-free (Pb≤100ppm).

2) 本体中的铅属于 ROHS 指令豁免的“玻璃中的铅”

The Pb in the resistor body is belong to the ROHS exemptions of “Pb in glass material”

※ 根据中国《电子信息产品污染控制管理办法》的规定，片式电阻器的有害物质情况如下：

According to the requirement of Administration on the Control of Pollution caused by Electronic Information Products, below are the hazardous substance information for the chip resistor:

部件名称 part name	有毒有害物质或元素 hazardous substance					
	铅 (Pb)	汞 (Hg)	镉 (Cd)	六价铬 (Cr <sup>6+</sup> )	多溴联苯 (PBB)	多溴二苯醚 (PBDE)
片式电阻器 chip resistor	×	○	○	○	○	○

○: 表示该有毒有害物质在该部件所有均质材料中的含量均在SJ/T11363-2006标准规定的限量要求以下。

○: Indicates that this toxic or hazardous substance contained in all of the homogeneous materials for this part is below the threshold requirement in ST/J11363-2006.

×: 表示该有毒有害物质至少在该部件的某一均质材料中的含量超出 SJ/T11363-2006 标准规定的限量要求。

×: Indicates that this toxic or hazardous substance contained in at least one of the homogeneous materials used for this part is above the threshold requirement in ST/J11363-2006.

※ 产品的环保使用期限标志如下：

The Environment Friendly Use Period logo as below:



备注：此环保使用期限只适用于产品是在本产品承认书中所规定的条件下工作。

Remarks: Above “Environment Friendly Use Period” only applicable under the condition specified in this approval sheet.

**8.0 表面处理无铅片阻推荐使用的焊接曲线 Recommended Soldering Profile**

■ 推荐的回流焊曲线 Recommended re-flow profile

回流3次 Re-flow 3 times

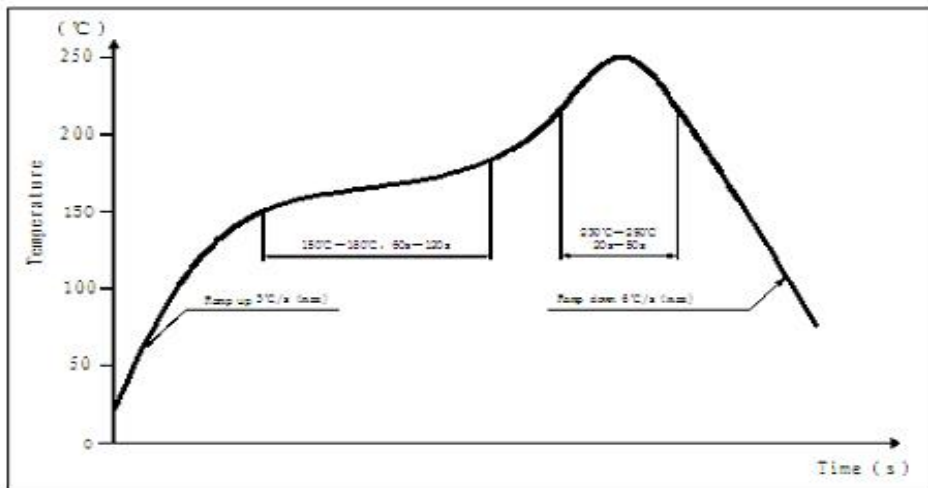



薄膜片式固定电阻器 Thin Film Chip Fixed Resistor

版本号 Version No: T-2.0

T Series

■ 推荐的波峰焊曲线 Recommended wave solder profile

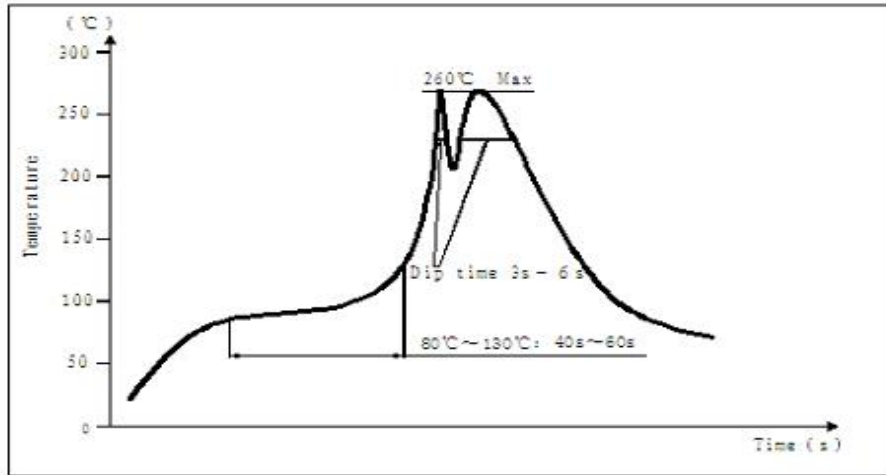

■ 推荐的 焊膏 / 焊锡 类型 Recommended solder alloy: 96.5Sn-3.0Ag-0.5Cu

9.0 使用说明 Chip Resistor Instructions for Use

n 本产品以下特殊环境下应用，性能可能会受到影响：

Application of the products in a special environment can deteriorate product performance:

1、在不同类型的液体，包括水，油，化学品，有机溶剂的使用。

Use in various types of liquid, including water, oils, chemicals, and organic solvents.

2、在户外直接暴露在阳光的地方，或在灰尘多的地方使用。

Use outdoors where the products are exposed to direct sunlight, or in dusty places.

3、在产品暴露的地方，有海风或腐蚀性气体，包括氯气，硫化氢，氨气，二氧化硫，二氧化氮等。

Use in places where the products are exposed to sea winds or corrosive gases, including  $Cl_2$ ,  $H_2S$ ,  $NH_3$ ,  $SO_2$ , and  $NO_2$  etc.

4、在产品暴露于静电或电磁波的地方使用。

Use in places where the products are exposed to static electricity or electromagnetic waves.

5、在产生热量的部件、塑料线，或其他易燃物品附近使用。

Use in proximity to heat-producing components, plastic cords, or other flammable items.

6、在用树脂或其他涂层材料密封产品的情况下使用。

Use involving sealing or coating the products with resin or other coating materials.

7、焊接后使用不洁焊料或使用水或水溶性清洗剂清洗产品。

Use involving unclean solder or use of water or water-soluble cleaning agents for cleaning after soldering.



薄膜片式固定电阻器 Thin Film Chip Fixed Resistor	版本号 Version No: T-2.0
T Series	

**10.0 产品使用注意事项 Precautions on Use of Products**

1、避免采用超过正常额定功率的功率，超过额定功率的稳态负载条件下可能会对产品性能和可靠性产生负面影响。

Avoid applying power exceeding normal rated power, exceeding the power rating under steady-state loading condition may negatively affect product performance and reliability.

2、用镊子拿起产品时要小心。有可能会将保护或电阻体夹碎。

Be careful when pick up the products with tweezers. There may be a care that the overcoat and / or the body can be chipped.

3、手工安装产品时，烙铁头不要触碰产品。

Soldering tip shall not touch the product when install product manually.

**n** 贮存条件:温度 5℃~30℃,相对湿度 30%~70%.

Storage conditions: T: 5℃~30℃,RH: 30%~70%.

建议在符合以上贮存条件下 6 个月内使用。

The products are suggested to be used within six months when received, and the storage condition mentioned above should be followed.

**n** 请您盖章确认后将复印件返还我司，如三个月后未返回我司将视做默认接受。

Be sure to return a copy to our company after stamping your company acceptance, if no copy returned after three months, we would judge that you shall receive and accept this approval sheet.

**n** 如承认书有任何变更，之前的版本自动作废。

If there is any amendment, a former version shall become invalid.

## X-ON Electronics

Largest Supplier of Electrical and Electronic Components

*Click to view similar products for* [Thick Film Resistors - SMD category:](#)

*Click to view products by* [Fenghua Advanced manufacturer:](#)

Other Similar products are found below :

[CR-05FL7--150R](#) [CR-05FL7--698K](#) [CR-12JP4--680R](#) [CRCW04021K20FKEE](#) [CRCW04028R20JNEE](#) [CRCW06032K10FKEC](#)  
[CRCW06036K80FKEE](#) [M55342K03B499DRS6](#) [M55342K06B6E19RWL](#) [M55342K09B5D62RS6](#) [M55342M06B26E7RS3](#) [742C083750JTR](#)  
[MCR01MRTF1001](#) [MCR01MZPF1202](#) [MCR01MZPF1601](#) [MCR01MZPF1800](#) [MCR01MZPF6201](#) [MCR01MZPF9102](#) [MCR01MZPJ121](#)  
[MCR01MZPJ125](#) [MCR01MZPJ751](#) [MCR03EZHZ103](#) [MCR03EZPF2004](#) [MCR03EZPJ270](#) [MCR03EZPJ821](#) [MCR10EZPF1102](#)  
[MCR18EZPJ330](#) [RC1005F1152CS](#) [RC1005F1372CS](#) [RC1005F2052CS](#) [RC1005F471CS](#) [RC1005F4751CS](#) [RC1005F5621CS](#)  
[RC1005F6041CS](#) [RC1005J121CS](#) [RC1005J122CS](#) [RC1005J180CS](#) [RC1005J181CS](#) [RC1005J202CS](#) [RC1005J391CS](#) [RC1005J512CS](#)  
[RC1005J683CS](#) [RC1005J823CS](#) [RC1608F333CS](#) [RC1608F5110CS](#) [RC1608J121CS](#) [RC2012F2493CS](#) [RC2012F2740CS](#) [RC2012J105CS](#)  
[RC2012J470CS](#)