

■ 高稳定性薄膜片式固定电阻器 - TH 系列

High Stability Thin Film Chip Fixed Resistor - TH Series

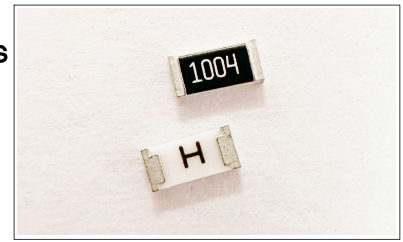

◆ 特点 Features

- * 低温度系数及高精度 ($\pm 0.05\%$; $\pm 5\text{ppm}/^\circ\text{C}$)
Low TCR and high accuracy ($\pm 0.05\%$; $\pm 5\text{ppm}/^\circ\text{C}$)
- * 适应再流焊与波峰焊
Suit for re-flow and wave soldering
- * 具有抗硫化性能
With good sulfuration-resistant performance
- * 符合RoHS指令要求
Compliant with RoHS directive
- * 符合无卤素要求
Halogen free requirement
- * 特殊钝化材料, 具有良好的耐湿性、耐腐蚀性、高可靠性
Using special passivation material, and has good moisture resistance, corrosion resistance, high reliability.

◆ 应用领域 Applications

医学仪器、测试/测量设备、打印设备、自动设备控制器、转换器、通讯设备、手机等。
 Medical Equipment, Test/Measurement Equipment, Printer Equipment, Automatic Equipment Controller, Converters, Communication Device, Mobile phone etc.

◆ 型号表示方法 Part Number

TH	E	05	G	1003	B	T					
产品代号 Product Code	额定功率代号 Power Rating Code		封装尺寸 Dimensions		电阻温度系数代号 T.C.R Code	电阻值代号 Resistance Value Code	阻值误差精度代号 Resistance Tolerance Code	包装方式代号 Packaging Style Code			
TH 系列 薄膜片式 固定电阻 TH Series Thin Film Chip Fixed Resistor	代号 Code	额定功率系列 Power rating	代号 Code	型号 Type	代号 Code	T.C.R (ppm/ $^\circ\text{C}$)	四位数字表示: 四digits 前三位表示有效数字, 第四位表示有效数字 后零的个数。 Four digits: The first three digits are significant figures and the four one denotes number of zeros. 小数点用R表示 Decimal point should be expressed by "R" 例如 Example: 4701: 4.7K Ω 1003: 100K Ω 10r5: 10.5 Ω	代号 Code	误差精度 Tolerance	代号 Code	包装方法 Packaging Style
	A	1/32W	01	0201	D	± 5	A	$\pm 0.05\%$	T	编带包装 Tape & Reel	
	C	1/16W	02	0402	E	± 10	B	$\pm 0.1\%$			
	D	1/10W	03	0603	F	± 15	C	$\pm 0.25\%$			
	E	1/8W	05	0805	G	± 25	D	$\pm 0.5\%$			
	F	1/4W	06	1206	H	± 50	F	$\pm 1\%$			
	G	1/2W	1210	1210							
	R	1/3W	10	2010							
	H	3/4W	12	2512							
	J	1W									

◆ 结构 Construction

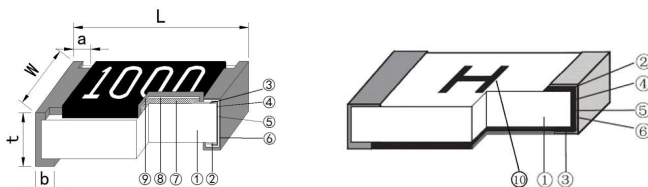

- ① 陶瓷基板 Ceramic Substrate
- ② 背电极 Bottom Electrode
- ③ 面电极 Top Electrode
- ④ 端电极 Edge Electrode
- ⑤ 中间电极 Barrier Layer
- ⑥ 外部电极 External Electrode
- ⑦ 电阻体 NiCr Resistor Layer
- ⑧ 钝化层 Passivation
- ⑨ 保护层 Protective Coating
- ⑩ 薄膜电阻专用识别码 Thin Film Chip Resistor Code

◆ 规格尺寸 Dimensions

单位 Unit:mm

型号 Type	L	w	t	a	b
0201	0.60 \pm 0.03	0.30 \pm 0.03	0.23 \pm 0.03	0.10 \pm 0.05	0.15 \pm 0.05
0402	1.00 \pm 0.05	0.50 \pm 0.05	0.30 \pm 0.05	0.20 \pm 0.10	0.25 \pm 0.10
0603	1.60 \pm 0.10	0.80 \pm 0.10	0.45 \pm 0.10	0.30 \pm 0.20	0.30 \pm 0.20
0805	2.00 \pm 0.10	1.25 \pm 0.15	0.50 \pm 0.10	0.30 \pm 0.20	0.40 \pm 0.20
1206	3.20 \pm 0.20	1.60 \pm 0.15	0.55 \pm 0.10	0.40 \pm 0.20	0.50 \pm 0.20
1210	3.20 \pm 0.20	2.50 \pm 0.20	0.55 \pm 0.10	0.40 \pm 0.20	0.50 \pm 0.20
2010	5.00 \pm 0.20	2.50 \pm 0.20	0.55 \pm 0.10	0.60 \pm 0.20	0.60 \pm 0.20
2512	6.40 \pm 0.20	3.20 \pm 0.20	0.55 \pm 0.10	0.60 \pm 0.20	0.60 \pm 0.20

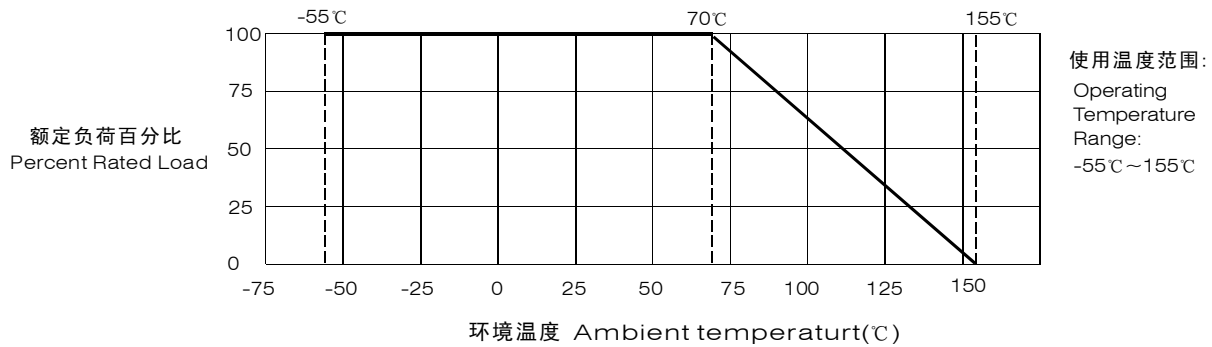
◆ 负荷下降曲线 Derating Curve

注：当电阻使用的环境温度超过70°C时，其额定负荷(额定功率)按上述曲线下降。

Note: For resistors operated in ambient over 70°C, rated load (rated power) shall be derated in accordance with the above figure.

◆ 额定值 Ratings

项目 Item 型号 Type	70°C下额定功率(注) Rated Power at 70°C (note)	元件极限电压 Limiting Element Voltage	最大过负荷电压 Max. Overload Voltage	阻值范围 Resistance Range					电阻温度系数 TCR (ppm/°C)
				±0.05%	±0.1%	±0.25%	±0.5%	±1%	
0201	1/32W	15V	30V	---	49.9Ω ~ 33KΩ				±25 ±50
0402	1/16W	25V	50V	49.9Ω ~ 4.99KΩ					±5
				49.9Ω ~ 30KΩ	10Ω ~ 47KΩ				±10 ±15
				49.9Ω ~ 50KΩ	10Ω ~ 150KΩ	10Ω ~ 250KΩ			±25 ±50
0603	N:1/16W H:1/10W	75V	150V	24.9Ω ~ 15KΩ					±5
				24.9Ω ~ 200KΩ	4.7Ω ~ 200KΩ				±10 ±15
				24.9Ω ~ 200KΩ	4.7Ω ~ 332KΩ	1Ω ~ 1MΩ			±25 ±50
0805	N:1/10W H:1/8W	150V	300V	24.9Ω ~ 30KΩ					±5
				24.9Ω ~ 330KΩ	4.7Ω ~ 510KΩ				±10 ±15
				24.9Ω ~ 330KΩ	4.7Ω ~ 1MΩ	1Ω ~ 1MΩ			±25 ±50
1206	N:1/8W H:1/4W	200V	400V	24.9Ω ~ 50KΩ					±5
				24.9Ω ~ 470KΩ	4.7Ω ~ 510KΩ				±10 ±15
				24.9Ω ~ 470KΩ	4.7Ω ~ 1MΩ	1Ω ~ 1MΩ			±25 ±50
1210	N:1/4W H:1/3W	200V	400V	24.9Ω ~ 50KΩ					±5
				24.9Ω ~ 470KΩ	4.7Ω ~ 510KΩ				±10 ±15
				24.9Ω ~ 470KΩ	4.7Ω ~ 1MΩ	1Ω ~ 1MΩ			±25 ±50
2010	N:1/4W H:1/3W	200V	400V	24.9Ω ~ 50KΩ					±5
				24.9Ω ~ 470KΩ	4.7Ω ~ 510KΩ				±10 ±15
				24.9Ω ~ 470KΩ	4.7Ω ~ 1MΩ	1Ω ~ 1MΩ			±25 ±50

备注：“N”表示常规功率系列，“H”表示高功率系列。

Remark: "N" for normal power series, "H" for high power series.

◆ 额定值 Ratings

(续上页 Continue)

项目 Item 型号 Type	70℃下额定功率(注) Rated Power at 70℃ (note)	元件极限电压 Limiting Element Voltage	最大过负荷电压 Max .Overload Voltage	阻值范围 Resistance Range					电阻温度系数 TCR (ppm/℃)
				±0.05%	±0.1%	±0.25%	±0.5%	±1%	
2512	N:1/2W	200V	400V	24.9Ω ~ 50KΩ					±5
	N:1/2W H:3/4W	200V	400V	24.9Ω~ 470KΩ	4.7Ω ~ 510KΩ				±10 ±15
				24.9Ω~ 470KΩ	4.7Ω ~ 1MΩ	1Ω ~ 1MΩ		±25 ±50	

 注：1、额定电压= $\sqrt{\text{额定功率} \times \text{标称电阻值}}$ 或元件极限电压中的较小值。

2、使用温度范围：-55℃ ~ 155℃。

3、“N”表示常规功率系列，“H”表示高功率系列。

 Note: 1、Rated Voltage= $\sqrt{\text{Power Rating} \times \text{Resistance Value}}$ or Limiting element voltage whichever is lower.

2、Operating temp. Range: -55℃ ~ 155℃.

3、"N"for normal power series,"H"for high power series.

◆ 特性 Characteristics

试验项目 Test Item	标准 Specification		测试方法 (IEC 60115-1) Test Method (IEC 60115-1)
	常规功率系列 Normal power rating	高功率系列 High power rating	
电阻温度系数 T.C.R	在规定值内 within specified T.C.R		IEC 60115-1 4.8 +25℃/-55℃/+25℃/+125℃/+25℃
绝缘电阻 Insulation Resistance	1000MΩ Min		IEC 60115-1 4.6 在电极与基片间施加100V±15V直流电压,保持1分钟,然后测绝缘电阻值。 Apply DC 100V±15V between substrate and termination for 1 minute, then check the insulation resistance.
耐电压 Voltage Proof	无击穿或电弧 No breakdown or flashover		IEC 60115-1 4.7 在电极与基片间以大约100V/s的速率施加有效值为最大过负荷电压的交流电压,保持60s±5s。 Apply max. overload voltage of AC RMS at a rate of approximately 100V/s between substrate and terminations for 60s±5s.
短时间过载 Short Time Overload	无可见损伤 No mechanical damage $\Delta R \leq \pm(0.2\%R+0.05\Omega)$	无可见损伤 No mechanical damage $\Delta R \leq \pm(0.5\%R+0.05\Omega)$	IEC 60115-1 4.13 施加2.5倍额定电压或最大过负荷电压(取较小者)持续5秒。 Apply 2.5 times rated voltage or Max overload voltage, whichever is lower, for 5 s.
耐焊接热 Resistance to Soldering Heat	无可见损伤 No mechanical damage $\Delta R \leq \pm(0.1\%R+0.05\Omega)$		IEC 60115-1 4.18 270℃±5℃ 10秒±1秒 270℃±5℃ 10s±1s
可焊性 Solder-ability	可焊面积≥95% 95% Cover Min		IEC 60115-1 4.17 245℃±5℃ 3秒±0.3秒 245℃±5℃ 3s±0.3s
温度快速变化 Rapid Change of Temperature	无可见损伤 No mechanical damage $\Delta R \leq \pm(0.1\%R+0.05\Omega)$		IEC 60115-1 4.19 -55℃~155℃ 100个循环 -55℃~155℃ 100 cycles.
70℃耐久性 Endurance at 70℃	无可见损伤 No mechanical damage $\Delta R \leq \pm(0.2\%R+0.05\Omega)$	无可见损伤 No mechanical damage $\Delta R \leq \pm(0.5\%R+0.05\Omega)$	IEC 60115-1 4.25.1 70℃±2℃额定电压或元件极限电压(取较小者)通1.5小时,断0.5小时,持续1000小时。 Resistor should be exposed at 70℃±2℃, and apply rated voltage or limiting element voltage, whichever is lower, for 1.5h on, 0.5h off for 1000h.

◆ 特性 Characteristics

(续上页 Continue)

試驗項目 Test Item	標 准 Specification		測試方法 (IEC 60115-1) Test Method (IEC 60115-1)
	常規功率系列 Normal power rating	高功率系列 High power rating	
稳态湿热 Damp Heat, Steady State	无可见损伤 No mechanical damage $\Delta R \leq \pm(0.2\%R+0.05\Omega)$	无可见损伤 No mechanical damage $\Delta R \leq \pm(0.5\%R+0.05\Omega)$	IEC 60115-1 4.24 40°C ± 2°C, 93% ± 3%RH, 额定电压或元件极限电压(取较小者)通1.5小时, 断0.5小时, 持续1000小时。 Resistor should be exposed at 40°C ± 2°C 93% ± 3%RH and apply rated voltage or limiting element voltage, whichever is lower, for 1.5h on, 0.5h off for 1000h.
低温负载 Operation at Low Temperature	无可见损伤 No mechanical damage $\Delta R \leq \pm(0.1\%R+0.05\Omega)$	无可见损伤 No mechanical damage $\Delta R \leq \pm(0.5\%R+0.05\Omega)$	IEC 60115-1 4.36 -55°C ± 5°C, 无负载1小时, 额定电压或元件极限电压(取较小值)45分钟, 无负载15分钟。 -55°C ± 5°C, 1h without load, rated voltage or limiting element voltage whichever is lower for 45min, 15min without load.
上限类别温度 耐久性 Endurance at Upper Category Temperature	无可见损伤 No mechanical damage $\Delta R \leq \pm(0.2\%R+0.05\Omega)$		IEC 60115-1 4.25.3 155°C ± 2°C 96小时。 Resistor should be exposed at 155°C ± 2°C for 96 hours.
基板弯曲试验 Substrate Bending Test	无可见损伤 No mechanical damage $\Delta R \leq \pm(0.1\%R+0.05\Omega)$		IEC 60115-1 4.33 保持时间(Duration): 60s ± 5s 弯曲距离(Bending Distance): 0201、0402、0603、0805: 5mm; 1206、1210: 4mm; 2010、2512: 2mm
抗硫化性能 Sulfuration- Resistant	无可见损伤 No mechanical damage $\Delta R \leq \pm(0.5\%R+0.05\Omega)$		切削油: 硫磺粉, 恒温: 105°C ± 3°C, 放置时间: 1000小时 Cutting oil :sulphur powder ,constant temperature: 105°C ± 3°C, for 1000h.

◆ 包装 Packaging

包装方式见附录 Packaging can refer to the Appendix.

附录 Appendix

◆ 推荐焊盘尺寸 Recommend Solder Pad Size

单位 unit: mm

- 片式固定电阻器 Chip fixed resistor

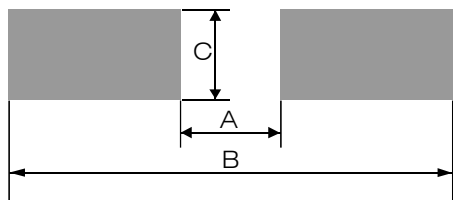

厚膜电阻及薄膜电阻 Thick Film Resistor and Thin Film Resistor			
型号 Type	A	B	C
01005	0.17 ± 0.03	0.60 ± 0.03	0.22 ± 0.03
0201	0.23 ± 0.05	0.84 ± 0.05	0.38 ± 0.05
0402	0.45 ± 0.05	1.45 ± 0.05	0.60 ± 0.05
0603	0.80 ± 0.05	2.50 ± 0.05	0.95 ± 0.05
0805	1.05 ± 0.1	3.25 ± 0.1	1.40 ± 0.1
1206	1.90 ± 0.1	4.50 ± 0.1	1.75 ± 0.1
1210	2.00 ± 0.1	4.60 ± 0.1	2.70 ± 0.1
2010	3.50 ± 0.1	6.50 ± 0.1	2.70 ± 0.1
2512 (1W、1.5W)	4.80 ± 0.1	7.80 ± 0.1	3.40 ± 0.1
2512 (2W)	2.70 ± 0.1	7.80 ± 0.1	3.60 ± 0.1
0508	0.60 ± 0.1	2.20 ± 0.1	2.00 ± 0.1
0612	0.60 ± 0.1	2.90 ± 0.1	3.30 ± 0.1
1225	1.40 ± 0.1	4.50 ± 0.1	6.40 ± 0.1

- 厚膜片式网络电阻器 Thick film chip network resistor

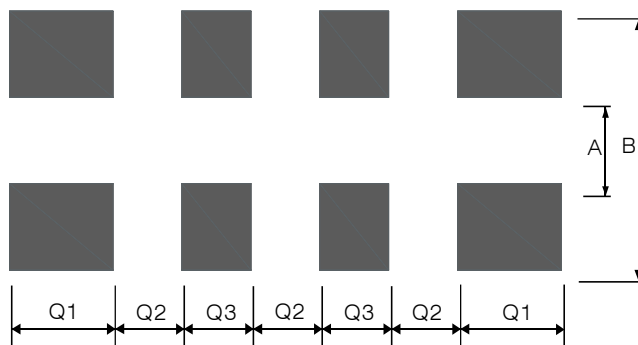

单位 unit: mm

型号 Type	A	B	Q1	Q2	Q3
2R01	0.30 ± 0.05	0.90 ± 0.05	0.30 ± 0.05	0.20 ± 0.05	---
4R01	0.30 ± 0.05	0.90 ± 0.05	0.20 ± 0.05	0.20 ± 0.05	0.20 ± 0.05
2R02	0.35 ± 0.05	1.25 ± 0.05	0.65 ± 0.05	0.20 ± 0.05	0.30 ± 0.05
4R02	0.38 ± 0.05	1.60 ± 0.05	0.40 ± 0.05	0.20 ± 0.05	---
4R03	0.80 ± 0.05	2.70 ± 0.05	0.60 ± 0.05	0.40 ± 0.05	0.40 ± 0.05
备注 Remarks	1、2R01型号包含including: RC-MY04、RCMY04、RH-MY04、RHMY04 2、4R01型号包含including: RC-MY08、RCMY08、RH-MY08、RHMY08 3、2R02型号包含including: RC-MT04、RCMT04、RH-MT04、RHMT04 4、4R02型号包含including: RC-MT08、RCMT08、RH-MT08、RHMT08 5、4R03型号包含including: RC-ML08、RCML08、RH-ML08、RHML08 6、上述型号说明适用于附录中所有型号。 The above description applies to all types in the appendix.				

◆ 包装 Packaging
● 纸带编带 Paper Taping

适用于01005、0201、0402、2R01、4R01、2R02、4R02:

For 01005、0201、0402、2R01、4R01、2R02、4R02:

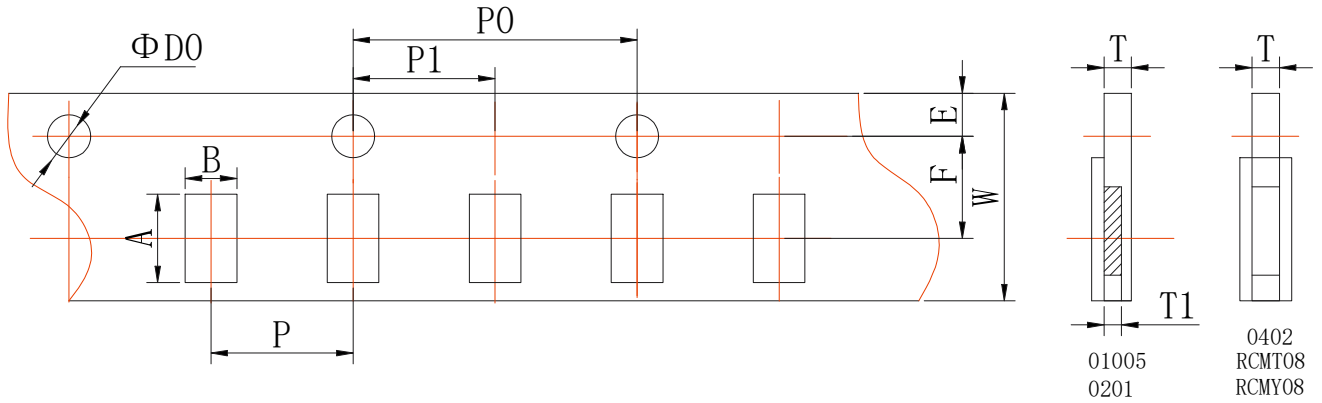

单位 unit: mm

型号 Type	A	B	W	F	E
01005	0.45±0.02	0.25±0.02	8.00±0.02	3.50±0.05	1.75±0.05
0201	0.70±0.10	0.40±0.10	8.00±0.20	3.50±0.05	1.75±0.10
0402	1.15±0.10	0.65±0.10	8.00±0.20	3.50±0.05	1.75±0.10
2R01	0.97±0.05	0.77±0.05	8.00±0.20	3.50±0.05	1.75±0.10
4R01	1.57±0.05	0.77±0.05	8.00±0.20	3.50±0.05	1.75±0.10
2R02	1.45±0.10	1.20±0.10	8.00±0.20	3.50±0.05	1.75±0.10
4R02	2.20±0.10	1.20±0.10	8.00±0.20	3.50±0.05	1.75±0.10

单位 unit: mm

型号 Type	P	P0	P1	ΦD0	T1	T
01005	2.00±0.05	4.00±0.10	2.00±0.05	1.55±0.02	0.17±0.02	0.31±0.02
0201	2.00±0.05	4.00±0.10	2.00±0.05	1.50±0.10	0.28±0.04	0.42±0.05
0402	2.00±0.05	4.00±0.10	2.00±0.05	1.50±0.10	/	0.44±0.05
2R01	2.00±0.10	4.00±0.10	2.00±0.05	1.50±0.10	/	0.60±0.10
4R01	2.00±0.10	4.00±0.10	2.00±0.05	1.50±0.10	/	0.60±0.10
2R02	2.00±0.10	4.00±0.10	2.00±0.05	1.50±0.10	/	0.60±0.10
4R02	2.00±0.10	4.00±0.10	2.00±0.05	1.50±0.10	/	0.60±0.10

适用于0603、0805、0508、1206、0612、1210、4R03:

For 0603、0805、0508、1206、0612、1210、4R03:

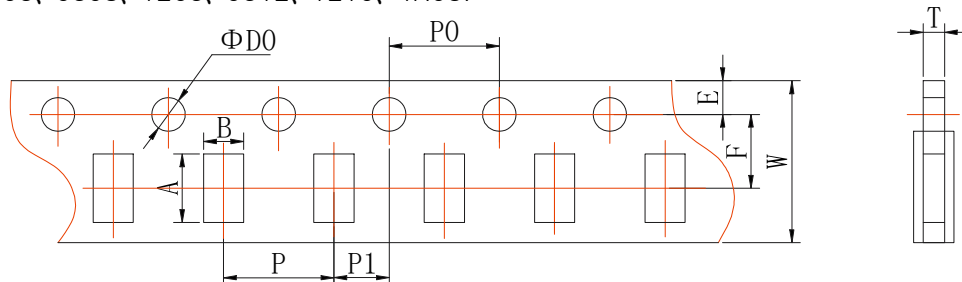

单位 unit: mm

型号 Type	A	B	W	F	E
0603	1.80±0.10	1.05±0.10	8.00±0.20	3.50±0.05	1.75±0.10
0805	2.30±0.10	1.50±0.10	8.00±0.20	3.50±0.05	1.75±0.10
0508	2.30±0.10	1.50±0.10	8.00±0.20	3.50±0.05	1.75±0.10
1206	3.50±0.20	1.90±0.20	8.00±0.20	3.50±0.05	1.75±0.10
0612	3.50±0.20	1.90±0.20	8.00±0.20	3.50±0.05	1.75±0.10
1210	3.50±0.20	2.80±0.20	8.00±0.20	3.50±0.05	1.75±0.10
4R03	3.50±0.20	1.90±0.20	8.00±0.20	3.50±0.05	1.75±0.10

单位 unit: mm

型号 Type	P	P0	P1	ΦD0	T	
					厚膜电阻及薄膜电阻 Thick Film Resistor and Thin Film Resistor	合金片式固定电阻 Metal Foil Resistor
0603	4.00±0.10	4.00±0.10	2.00±0.05	1.50±0.10	0.60±0.10	0.75±0.10
0805	4.00±0.10	4.00±0.10	2.00±0.05	1.50±0.10	0.75±0.10	0.95±0.10
0508	4.00±0.10	4.00±0.10	2.00±0.05	1.50±0.10	0.75±0.10	0.95±0.10
1206	4.00±0.10	4.00±0.10	2.00±0.05	1.50±0.10	0.75±0.10	0.95±0.10
0612	4.00±0.10	4.00±0.10	2.00±0.05	1.50±0.10	0.75±0.10	0.95±0.10
1210	4.00±0.10	4.00±0.10	2.00±0.05	1.50±0.10	0.75±0.10	---
4R03	4.00±0.10	4.00±0.10	2.00±0.05	1.50±0.10	0.75±0.10	---

● 塑料带编带 Embossed Taping

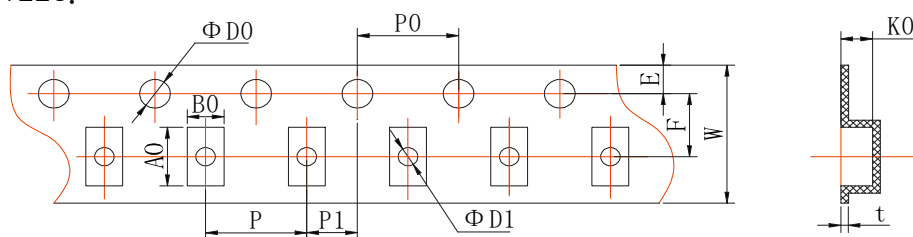
 适用于2010、2512、1225;
 For 2010、2512、1225:

单位 unit: mm

型号 Type	A0	B0	W	F	E	t
2010	5.50±0.15	2.82±0.15	12.00±0.10	5.50±0.10	1.75±0.10	0.25±0.05
2512	6.78±0.15	3.45±0.15	12.00±0.10	5.50±0.10	1.75±0.10	0.25±0.05
1225	6.78±0.15	3.45±0.15	12.00±0.10	5.50±0.10	1.75±0.10	0.25±0.05

单位 unit: mm

型号 Type	P	P0	P1	ΦD0	ΦD1	K0	
						厚膜电阻及薄膜电阻 Thick Film Resistor and Thin Film Resistor	合金片式固定电阻 Metal Foil Resistor
2010	4.00±0.10	4.00±0.10	2.00±0.05	1.50+0.10/-0	1.50±0.10	0.84±0.10	0.84±0.10
2512	4.00±0.10	4.00±0.10	2.00±0.05	1.50+0.10/-0	1.50±0.10	0.81±0.10	1.00±0.10
1225	4.00±0.10	4.00±0.10	2.00±0.05	1.50+0.10/-0	1.50±0.10	0.81±0.10	1.00±0.10

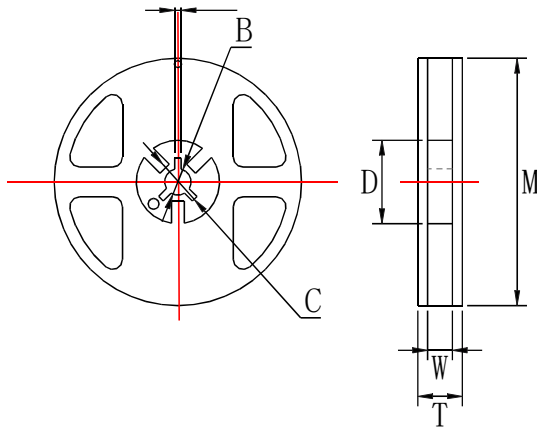
● 卷盘 Reel

单位 unit: mm

卷盘尺寸 Reel Type	型号 Type	M	W	T	A	B	C	D
7英寸 7inch dia.Reel	01005、0201 0402、0603 0805、1206 1210、2R01 4R01、2R02 4R02、4R03 0508、0612	178±2.0	9.5±1.0	12.5±1.5	2.0±0.5	13.0±0.5	21.0±0.5	58.0±2.0
	2010、2512 1225	178±2.0	13.0±0.5	15.5±1.5	2.0±0.5	13.0±0.5	21.0±0.5	57.0±2.0
13英寸 13inch dia.Reel	0201、0402 0603、0805 1206	330±2.0	9.5±1.0	13.4±1.0	2.0±0.5	13.0±0.5	21.0±0.5	100.0±1.0

● 编带包装能力 Taping Ability

面带拉力 Top tape peel strength

面带拉力强度为11~70g(0.1N~0.7N) ，速度：300mm/min,经下列试验后不允许有破裂断带现象。

Peel strength is 11~70g (0.1N~0.7N),with speed of 300mm/min,and should not have flash and tear after peeling.

测试方法Test method:

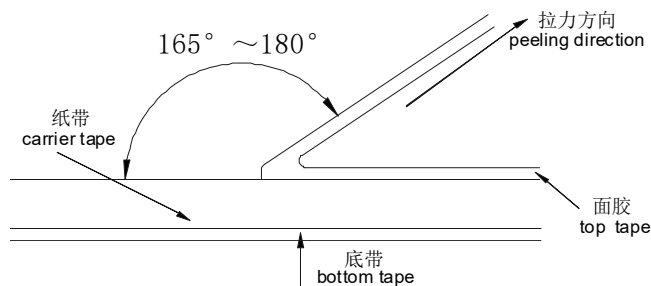

电阻松动自如，无粘面胶带、底胶带现象。

Resistor is free, no sticking to top tape and bottom tape.

电阻易从纸带中取出，且晶片孔无机械损伤。

Resistor is easy to take out from carrier tape and chip hole have no mechanical damage.

● 包装数量 Packaging Quantity

包装方法 Packaging style	7英寸卷盘 7inch dia.Reel					13英寸卷盘 13inch dia.Reel	
	01005	0201	0402、2R01 2R02、4R01 4R02	0603、0805 1206、1210 4R03、0508 0612	2010、2512 1225	0201、0402	0603、0805 1206
型号 Type	01005	0201	0402、2R01 2R02、4R01 4R02	0603、0805 1206、1210 4R03、0508 0612	2010、2512 1225	0201、0402	0603、0805 1206
数量 Quantity(pcs)	20000	15000	10000	5000	4000	50000	20000

◆ IEC E-24、E-96系列电阻值代码对照表
IEC E-24、E-96 Series Resistance Cross-reference List
● E-24 系列 E-24 series($\times 10^n\Omega$)

 (单位 unit: 0.001 Ω 、0.01 Ω 、0.1 Ω 、1 Ω 、10 Ω 、100 Ω 、1k Ω 、10k Ω 、100k Ω 、1M Ω 、10M Ω 、100M Ω 、1000M Ω)

表一 Table One:

1.0	1.5	2.2	3.3	4.7	6.8
1.1	1.6	2.4	3.6	5.1	7.5
1.2	1.8	2.7	3.9	5.6	8.2
1.3	2.0	3.0	4.3	6.2	9.1

● E-96系列 E-96 series ($\times 10^n\Omega$)

 (单位unit: 0.001 Ω 、0.01 Ω 、0.1 Ω 、1 Ω 、10 Ω 、100 Ω 、1k Ω 、10k Ω 、100k Ω 、1M Ω 、10M Ω 、100M Ω 、1000M Ω)

表二 Table Two:

1.00	1.33	1.78	2.37	3.16	4.22	5.62	7.50
1.02	1.37	1.82	2.43	3.24	4.32	5.76	7.68
1.05	1.40	1.87	2.49	3.32	4.42	5.90	7.87
1.07	1.43	1.91	2.55	3.40	4.53	6.04	8.06
1.10	1.47	1.96	2.61	3.48	4.64	6.19	8.25
1.13	1.50	2.00	2.67	3.57	4.75	6.34	8.45
1.15	1.54	2.05	2.74	3.65	4.87	6.49	8.66
1.18	1.58	2.10	2.80	3.74	4.99	6.65	8.87
1.21	1.62	2.15	2.87	3.83	5.11	6.81	9.09
1.24	1.65	2.21	2.94	3.92	5.23	6.98	9.31
1.27	1.69	2.26	3.01	4.02	5.36	7.15	9.53
1.30	1.74	2.32	3.09	4.12	5.49	7.32	9.76

● E-96系列0603型号《乘数代码对照表》及《电阻值代码对照表》

E-96 series(0603)《multiplied Cross-reference List》and《Resistance Cross-reference List》

表三 Table Three:

乘数multiplied	$\times 10^0$	$\times 10^1$	$\times 10^2$	$\times 10^3$	$\times 10^4$	$\times 10^5$	$\times 10^6$	$\times 10^7$	$\times 10^{-1}$	$\times 10^{-2}$	$\times 10^{-3}$
代码 code	A	B	C	D	E	F	G	H	X	Y	Z

表四 Table Four:

代号 Code	E-96系列电阻 E-96 resistance	代号 Code	E-96系列电阻 E-96 resistance	代号 Code	E-96系列电阻 E-96 resistance	代号 Code	E-96系列电阻 E-96 resistance
01	100	25	178	49	316	73	562
02	102	26	182	50	324	74	576
03	105	27	187	51	332	75	590
04	107	28	191	52	340	76	604
05	110	29	196	53	348	77	619
06	113	30	200	54	357	78	634
07	115	31	205	55	365	79	649
08	118	32	210	56	374	80	665
09	121	33	215	57	383	81	681
10	124	34	221	58	392	82	698
11	127	35	226	59	402	83	715
12	130	36	232	60	412	84	732
13	133	37	237	61	422	85	750
14	137	38	243	62	432	86	768
15	140	39	249	63	442	87	787
16	143	40	255	64	453	88	806
17	147	41	261	65	464	89	825
18	150	42	267	66	475	90	845
19	154	43	274	67	487	91	866
20	158	44	280	68	499	92	887
21	162	45	287	69	511	93	909
22	165	46	294	70	523	94	931
23	169	47	301	71	536	95	953
24	174	48	309	72	549	96	976

◆ 厚膜电阻阻值代码及标记规则
Description for Resistance Value Code and Marking of Thick Film Chip Resistor
● 阻值代码 Resistance Value Code



所有厚膜电阻的阻值代码与其标记是相对应的。

All the resistance value code of thick film chip resistor is corresponding with the marking .

● 标记 Marking

* E-24系列(≥ 0603 、 $\geq \pm 5\%$): 采用三位数字表示, 前二位表示电阻值有效数字, 第三位表示乘以10的次方数。

E-24 series: Express resistance value on the glass side with three digits, the first two digits should be significant and the third one denote number of zeros.

例 For example:  \longrightarrow 30K Ω  \longrightarrow 33 Ω

* E-24系列 (0603、 $\leq \pm 1\%$): 在三位数字标记下方增加下横线识别。

E-24 series(0603、 $\leq \pm 1\%$): Three digits with one short bar under marking letter.

例 For example: 

* E-96系列和E24系列 (0508、0805、0612、1206、1225、1210、2010、2512、 $\pm 1\%$ & $\pm 0.5\%$) :

▲ 采用四位数字表示, 前三位表示电阻值有效数字, 第四位表示乘以10的次方数。

E-96 series & E-24 series (0508、0805、0612、1206、1225、1210、2010、2512、 $\pm 1\%$ & $\pm 0.5\%$):

Express the resistance value with four digits, the first three digits are significant figures and the fourth denotes the number of zeros.

例 For example:  \longrightarrow 100K Ω

* E-96系列 (0603、 $\leq \pm 1\%$):

▲ 采用三位代码表示, 前二位表示E-96系列阻值代码, 后一位字母表示乘数代码 (见表三和表四)。

Express the resistance value with three code, the first two digit code denote the resistance of E-96 series, and the third code of letter denote the multiplier

(see the table three and four).

例 For example:  \longrightarrow 2M Ω

* 小数点以“R”表示 The decimal point should be expressed by “R” .

例 For example:  \longrightarrow 5.6 Ω  \longrightarrow 22 Ω

* 跨接电阻以“0”表示 The jumper should be expressed by “0”

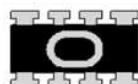
例 For example:  \longrightarrow 0 Ω  \longrightarrow 0 Ω

* ≤ 0402 产品不作标记 For the chip resistor(≤ 0402), there is no mark on the glass side.

例 For example: 

* 非IEC标准系列的电阻值标记表示方法: 一般以最接近IEC E24系列标称阻值的标记表示方法。

For the resistance which don't belong to IEC serial, use the resistance of IEC serial which is most close to the required resistance of non-IEC serial for replacement.

* 客户对标记有特殊要求时, 则按照协商的结果印刷标记。

To get agreement by both party if there special requirement for the marking.

◆ 薄膜电阻阻值代码及标记规则
Description for Resistance Value Code and Marking of Thin Film Chip Resistor
● 阻值代码 Resistance Value Code

所有薄膜电阻全尺寸统一采用四位数阻值代码表示。

All resistance value code of thin film chip resistor used four digits.

例 Example

TD03G4701BT

四位数代号表示，如：4701=4.7KΩ；1R50=1.5Ω

To use four digits code represent resistance value，

例 Example 4701=4.7KΩ；1R50=1.5Ω

● 标记 Marking

* 当阻值同时存在于E24和E96系列时，优先采用E96系列。

When resistance value belongs to E24 as well as E96 series, we suggest preferentially use E96 series.

例 Example 10K=1002, ≠103

* ≥0805 产品标记 For the chip resistor (≥0805):

▲ 印刷四位数字代码；

Express the resistance value with four digits code;

例 Example



* 0603标记 Marking for 0603 Size Resistor

▲ 0603-E96系列：印刷三位字母代码；

For resistance value belongs to E96 series, express the resistance value with three digits code.

例 Example



▲ 0603-E24系列：印刷三位数字代码；

For resistance value belongs to E24 series, express the resistance value with three digits code.

例 Example



* ▲ 小数点以"R"表示 The decimal point should be expressed by"R".

例 Example



* ≤0402产品：不作标记 For the chip resistor (≤0402), there is no mark on the glass side.

例 Example



◆ 电流检测电阻阻值代码及标记规则
Description for Resistance Value Code and Marking of Current Sensing Thick Film Chip Resistor
● 阻值代码 Resistance Value Code

所有电流检测电阻全尺寸 统一采用四位数阻值代码表示。

All resistance value code of current sensing thick film chip resistor used four digits.

例 Example

RBF03MR010FT

四位数代号表示, 如: R010=10mΩ ; 30M1=30.1mΩ

To use four digits code represent resistance value ,

例 Example R010=10mΩ ; 30M1=30.1mΩ

● 标记 Marking

* E-24和E-96系列(0508、0805、0612、1206、1225、1210、2010、2512、 $\leq \pm 5\%$): 采用四位标记代码。

For the chip resistor (0508、0805、0612、1206、1225、1210、2010、2512 $\leq \pm 5\%$), when resistance value belongs to E24 and E96 series, we suggest preferentially use four digits.

标记代码 Mark Code	阻值范围 Resistance Value	示例 Sample
R00X	$1\text{m}\Omega \leq R \leq 9\text{m}\Omega$	R005=5mΩ
R0XX	$10\text{m}\Omega \leq R \leq 99\text{m}\Omega$	R033=33mΩ
RXXX	$100\text{m}\Omega \leq R \leq 999\text{m}\Omega$	R100=100mΩ
XMXX	$1\text{m}\Omega < R < 10\text{m}\Omega$ (包含小数点后两位有效数字) (Contains two significant digits after the decimal point.)	5M10=5.1mΩ
XXMX	$10\text{m}\Omega < R < 100\text{m}\Omega$ (包含小数点后一位有效数字) (Contains one significant digit after the decimal point.)	30M1=30.1mΩ

* E-24和E-96系列(0603, $\leq \pm 5\%$): 采用三位标记代码。

For the chip resistor (0603, $\leq \pm 5\%$), when resistance value belongs to E24 and E96 series, we suggest preferentially use three digits.

标记代码 Mark Code	阻值范围 Resistance Value Range	示例 Sample
V0X	$1\text{m}\Omega \leq R \leq 9\text{m}\Omega$	V05=5mΩ
VXX	$10\text{m}\Omega \leq R \leq 99\text{m}\Omega$	V33=33mΩ
RXX	$100\text{m}\Omega \leq R \leq 999\text{m}\Omega$	R10=100mΩ
XXM	$1\text{m}\Omega < R < 10\text{m}\Omega$ (包含小数点后一位有效数字) (Contains one significant digit after the decimal point.)	5M1=5.1mΩ

* ≤ 0402 产品不印刷标记。

For the chip resistor (≤ 0402), there is no mark on the glass side.

* 非IEC标准系列的电阻值标记表示方法: 一般以最接近IEC E24系列标称阻值的标记表示方法。

For the resistance which don't belong to IEC serial, use the resistance of IEC serial which is most close to the required resistance of non-IEC serial for replacement.

* 客户对标记有特殊要求时, 则按照协商的结果印刷标记。

To get agreement by both party if there special requirement for the marking.

◆片式电阻器使用说明 Chip Resistor Instructions for Use

● 本产品以下特殊环境下应用，性能可能会受到影响：

- 1、在各种类型的液体，包括水、油、化学品、有机溶剂的使用。
- 2、在户外直接暴露在阳光的地方，或在灰尘多的地方使用。
- 3、在产品暴露的地方，有海风或腐蚀性气体，包括氯气、硫化氢、氨气、二氧化硫、二氧化氮等。
- 4、在产品暴露于静电或电磁波的地方使用。
- 5、在产生热量的部件、塑料线，或其他易燃物品附近使用。
- 6、在用树脂或其他涂层材料密封产品的情况下使用。
- 7、焊接后使用不洁焊料或使用水或水溶性清洗剂清洗产品。
- 8、片状电阻器的基材是氧化铝。由于和安装基板的热膨胀系数不同，在反复施加提供热循环等热应力时，接合部的焊锡（焊缝部）有时会发生裂纹。如果环境温度反复发生很大的变动，并且载荷反复进行ON/OFF，则需要注意龟裂的发生。因热应力而发生的龟裂，取决于所安装的焊盘的大小、焊锡量、安装基板的散热性等，因此在环境温度有很大的变化或载荷ON/OFF的条件下使用时，请充分注意以进行设计。

◆ Application of the products in a special environment can deteriorate product performance:

- 1、Use in various types of liquid, including water, oils, chemicals, and organic solvents.
- 2、Use outdoors where the products are exposed to direct sunlight, or in dusty places.
- 3、Use in places where the products are exposed to sea winds or corrosive gases, including Cl_2 , H_2S , NH_3 , SO_2 , and No_2 etc.
- 4、Use in places where the products are exposed to static electricity or electromagnetic waves.
- 5、Use in proximity to heat-producing components, plastic cords, or other flammable items.
- 6、Use involving sealing or coating the products with resin or other coating materials.
- 7、Use involving unclean solder or use of water or water-soluble cleaning agents for cleaning after soldering.
- 8、The substrate of chip resistors is alumina. Cracks may occur at the connection of solder (solder fillet portion) due to the difference of the coefficient of thermal expansion from a mounting board when heat stress like heat cycle, etc. are repeatedly given to them. Care should be taken to the occurrence of the cracks when the change in ambient temperature or ON/OFF of load is repeated. The occurrence of the crack by heat stress may be influenced by the size of a pad, solder volume, heat radiation of mounting board etc., so please pay careful attention to designing when a big change in ambient temperature and conditions for use like ON/OFF of load can be assumed.

◆ 产品使用注意事项

- 1、避免采用超过正常额定功率的功率，超过额定功率的稳态负载条件下可能会对产品性能和可靠性产生负面影响。
- 2、用镊子拿起产品时要小心，有可能会将保护或电阻体夹碎。
- 3、手动安装产品时，烙铁头勿触碰产品。
- 4、贮存条件：温度 $5^{\circ}C \sim 30^{\circ}C$ ，相对湿度30%~70%。
建议在符合上述储存条件下六个月内使用。
- 5、用于车载设备、医疗设备、航空设备以及其它涉及人身安全、或可能引起重大损失的设备上时，请务必事先与我公司联系。这些产品在这类用途中出现故障或失灵可能导致人身事故或严重损坏。

◆ Precautions on use of products

- 1、Avoid applying power exceeding normal rated power, exceeding the power rating under steady-state loading condition may negatively affect product performance and reliability.
- 2、Be careful when pick up the products with tweezers. There may be a care that the overcoat and / or the body can be chipped.
- 3、Soldering tip shall not touch the product when install product manually.
- 4、Storage conditions: T: $5^{\circ}C \sim 30^{\circ}C$, RH: 30%~70%.
The products are suggested to be used within six months when received, and the storage condition mentioned above should be followed.
- 5、Contact our sales representatives before you use our products for applications including automotive, medical equipment and aerospace equipment. Malfunction or failure of the products in such applications may cause loss of human life or serious damage.

◆ 焊接 Soldering

- 推荐的回流焊曲线 Recommended reflow profile
- 推荐的波峰焊曲线 Recommended wave solder profile

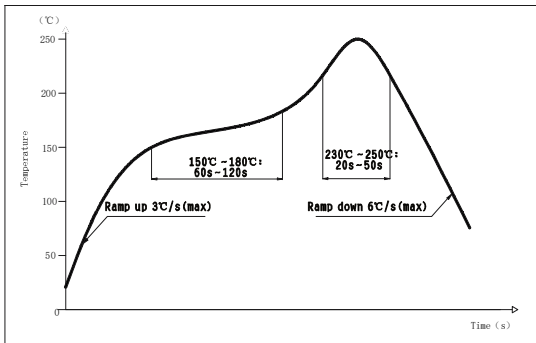

- 推荐的焊膏类型 Recommended solder alloy: 96.5Sn/3.0Ag/0.5Cu

■ 修订履历 Revision History

版本Version	日期Date	修订内容 Change Description	修改确认 Checked by
V2020.0	2020-06-23	- 原版 The original version.	吴晓玲 Xiaoling Wu
V2020.1.0	2020-10-15	- “结构”增加薄膜电阻产品背面示意图 Add the construction diagram of bottom of thin film chip resistor.	麦俊 Jun Mai
V2020.2.0	2021-01-15	- 修改额定值参数 Revise the parameters of Ratings.	麦俊 Jun Mai
V2020.3.0	2021-02-24	- 删除 E-24系列 客户特殊要求标记说明 Delete marking instructions for special requirements of customers	杜建业 Jianye Du
V4.0	2021-08-13	- 增加 “应用领域”。 Add the application. - 附录中“推荐焊盘尺寸”：增加偏差值。 Add the tolerance to Recommend Solder Pad Size.	卢振强 Zhenqiang Lu
V5.0	2021-12-10	- 修改“额定值”阻值范围 Revise the resistance range in ratings.	陈洁峰 Jiefeng Chen
V6.0	2022-02-25	- 附录中“包装数量”：修改0201尺寸为15K包装数量。 Revise the quantity of 0201 15Kpcs to Packaging Quantity.	杜建业 Jianye Du
V7.0	2022-03-21	- 修改“额定值”中0201的阻值精度范围。 Revise the tolerance range of 0201.	张继康 Jikang Zhang
V8.0	2022-06-16	- 修改产品标记由数码体改为手写体。 Modify the product marking from digital to handwritten. - 修改“额定值”中的“阻值范围”。 Modify the resistance range of Ratings..	杜建业 Jianye Du 张继康 Jikang Zhang
V9.0	2023-02-20	- 附录：增加RH-MY04, RH-MY08产品编带包装参数。 Appendix: Add the taping parameters of RH-MY04, RH-MY08. - 附录：修改0201,0402,0603,0805编带包装A,B,T参数。 Appendix: Modify the taping parameters A,B,T of 0201,0402,0603,0805.	卢振强 Zhenqiang Lu

注：上述所提供之内容为产品规格说明。在产品未变更时，风华保有修改此内容不另行通知之所有权利，任何产品变更将会以PCN通知客户。

Remark: Information provided above is intended to indicate product specifications only. Fenghua reserves all the rights for revising this content without further notification, as long as products are unchanged. Any product change will be announced by PCN.

X-ON Electronics

Largest Supplier of Electrical and Electronic Components

Click to view similar products for [Thick Film Resistors - SMD category:](#)

Click to view products by [Fenghua Advanced manufacturer:](#)

Other Similar products are found below :

[CR-05FL7--150R](#) [CR-05FL7--698K](#) [CR-12JP4--680R](#) [CRCW04021K20FKEE](#) [CRCW04028R20JNEE](#) [CRCW06032K10FKEC](#)
[CRCW06036K80FKEE](#) [M55342K03B499DRS6](#) [M55342K06B6E19RWL](#) [M55342K09B5D62RS6](#) [M55342M06B26E7RS3](#) [742C083750JTR](#)
[MCR01MRTF1001](#) [MCR01MZPF1202](#) [MCR01MZPF1601](#) [MCR01MZPF1800](#) [MCR01MZPF6201](#) [MCR01MZPF9102](#) [MCR01MZPJ121](#)
[MCR01MZPJ125](#) [MCR01MZPJ751](#) [MCR03EZHZ103](#) [MCR03EZPF2004](#) [MCR03EZPJ270](#) [MCR03EZPJ821](#) [MCR10EZPF1102](#)
[MCR10EZPF2700](#) [MCR18EZPJ330](#) [RC1005F1152CS](#) [RC1005F1372CS](#) [RC1005F2052CS](#) [RC1005F471CS](#) [RC1005F4751CS](#)
[RC1005F5621CS](#) [RC1005F6041CS](#) [RC1005J121CS](#) [RC1005J122CS](#) [RC1005J180CS](#) [RC1005J181CS](#) [RC1005J202CS](#) [RC1005J391CS](#)
[RC1005J512CS](#) [RC1005J683CS](#) [RC1005J823CS](#) [RC1608F333CS](#) [RC1608F5110CS](#) [RC1608J121CS](#) [RC2012F2493CS](#) [RC2012F2740CS](#)
[RC2012J105CS](#)