



承 认 书

APPROVAL SHEET

客户名称:

Customer

产品名称:

Part Name

产品规格:

Specification

版本号:

Version No.

日期:

DATE

/

叠层片式高频电感

Chip high frequency inductors

VHF060303HQ□□T Series

21.01

2021-5-6

| Manufacturer | | | Customer | | |
|--------------|------------|------------|----------|------------|-------------|
| 拟制 | 审核 | 确认 | 检验 | 审核 | 批准 |
| Draft by | Checked by | Approve by | Check by | Checked by | Approval by |
| 徐雪枫 | 何佳明 | 滕冲 | | | |



| 序号 No | 目 录 TABLE OF CONTENTS |
|----------|---|
| 1 | 外形尺寸与内部结构 Dimension & Inner-configuration |
| 2 | 产品品名构成 Product Spec. Model |
| 3 | 电性能参数表 Electrical Characteristics List |
| 4 | 可靠性试验项目 Reliability Testing Items |
| 5 | 产品包装 Packaging |
| 6 | 推荐焊接条件 Recommend Soldering Conditions |
| 7 | 清洗 Cleaning |
| 8 | 存储要求 Storage Requirements |
| 9 | ODS (消耗臭氧层物质) 的使用情况 Usage Of ODS |
| 10 | 注意事项 Notes |



1 外形尺寸与内部结构 Dimension & Inner-configuration:

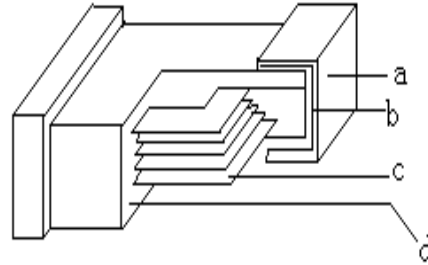
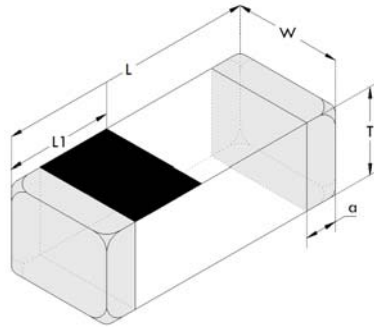

- a. 镀层 Ni/Sn plating
- b. 银层 Ag layer
- c. 内电极 Inner electrode
- d. 瓷体 Body

| 序号 No. | 部位 Component | 材料 Material | |
|--------|---------------------------|--|------------|
| 1 | 瓷体Body | 甚高频电感：陶瓷体系Al ₂ O ₃ | |
| 2 | 内电极Inner electrode | 纯银Ag | |
| 3 | 端电极 Terminal electrode | 银层 Ag layer | 银Ag |
| | | Ni/Sn镀层Ni/Sn plating | 镍层-锡层Ni-Sn |

单位Unit: mm(inch)

| 型号 Size | L | W | T | a | L1 |
|---------|------------------------|------------------------|------------------------|-------------------------|------------------------|
| 060303 | 0.6±0.03 (0.024±0.001) | 0.3±0.03 (0.012±0.001) | 0.3±0.03 (0.012±0.001) | 0.15±0.05 (0.006±0.002) | 0.3±0.03 (0.012±0.001) |
| | | | | | |

2 产品品名构成 Product Spec. Model

VHF 060303 HQ 1N0 □ T

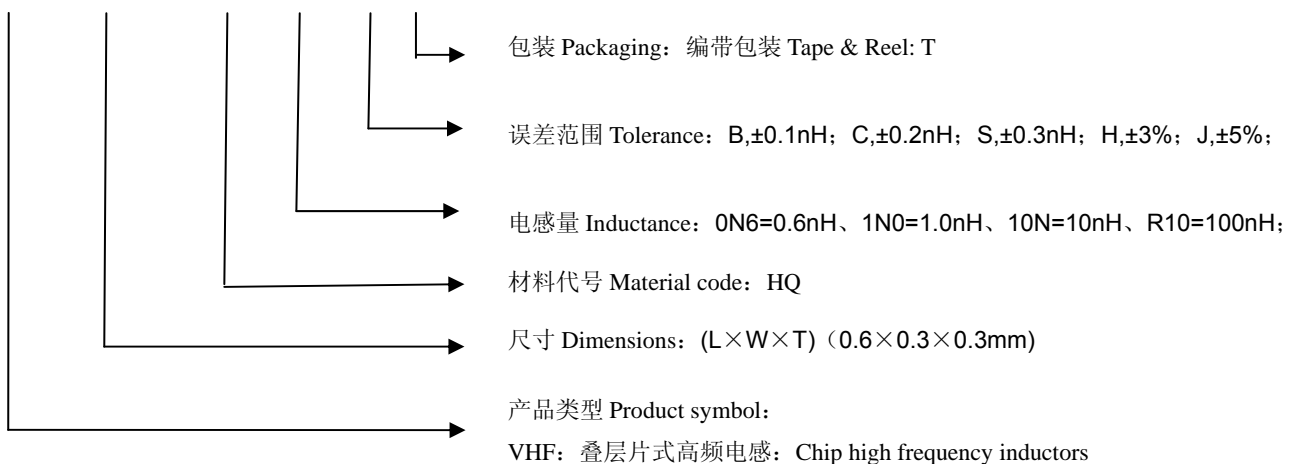



3 电性能参数表 Electrical Characteristics List

| 型号规格 Part NO. | 客户料号 Customer P/N | 标称感量 Inductance (nH) | Q 值 (min) | 直流电阻 RDC (Ω) max | 测试频率 Test frequency (MHz) | 测试电压 Test voltage (mV) | 自谐振频率 SRF (MHz) min | 额定电流 Rated current (mA)max |
|------------------|----------------------|-------------------------|--------------|------------------------------|------------------------------|---------------------------|------------------------|-------------------------------|
| VHF060303HQ0N6□T | | 0.6 | 14 | 0.05 | 500 | 50 | 10000 | 1000 |
| VHF060303HQ0N7□T | | 0.7 | 14 | 0.05 | 500 | 50 | 10000 | 1000 |
| VHF060303HQ0N8□T | | 0.8 | 14 | 0.06 | 500 | 50 | 10000 | 1000 |
| VHF060303HQ0N9□T | | 0.9 | 14 | 0.06 | 500 | 50 | 10000 | 800 |
| VHF060303HQ1N0□T | | 1.0 | 14 | 0.07 | 500 | 50 | 10000 | 800 |
| VHF060303HQ1N1□T | | 1.1 | 14 | 0.07 | 500 | 50 | 10000 | 800 |
| VHF060303HQ1N2□T | | 1.2 | 14 | 0.10 | 500 | 50 | 10000 | 800 |
| VHF060303HQ1N3□T | | 1.3 | 14 | 0.10 | 500 | 50 | 10000 | 700 |
| VHF060303HQ1N4□T | | 1.4 | 14 | 0.10 | 500 | 50 | 10000 | 700 |
| VHF060303HQ1N5□T | | 1.5 | 14 | 0.10 | 500 | 50 | 10000 | 650 |
| VHF060303HQ1N6□T | | 1.6 | 14 | 0.10 | 500 | 50 | 10000 | 650 |
| VHF060303HQ1N7□T | | 1.7 | 14 | 0.10 | 500 | 50 | 10000 | 650 |
| VHF060303HQ1N8□T | | 1.8 | 14 | 0.15 | 500 | 50 | 9000 | 650 |
| VHF060303HQ2N0□T | | 2.0 | 14 | 0.15 | 500 | 50 | 8500 | 650 |
| VHF060303HQ2N2□T | | 2.2 | 14 | 0.15 | 500 | 50 | 7500 | 650 |
| VHF060303HQ2N4□T | | 2.4 | 14 | 0.15 | 500 | 50 | 7500 | 550 |
| VHF060303HQ2N6□T | | 2.6 | 14 | 0.20 | 500 | 50 | 7500 | 550 |
| VHF060303HQ2N7□T | | 2.7 | 14 | 0.20 | 500 | 50 | 7500 | 550 |
| VHF060303HQ2N8□T | | 2.8 | 14 | 0.20 | 500 | 50 | 7500 | 500 |
| VHF060303HQ3N0□T | | 3.0 | 14 | 0.20 | 500 | 50 | 7500 | 450 |
| VHF060303HQ3N3□T | | 3.3 | 14 | 0.25 | 500 | 50 | 7500 | 450 |
| VHF060303HQ3N6□T | | 3.6 | 14 | 0.25 | 500 | 50 | 6500 | 400 |
| VHF060303HQ3N9□T | | 3.9 | 14 | 0.25 | 500 | 50 | 6500 | 400 |
| VHF060303HQ4N3□T | | 4.3 | 14 | 0.35 | 500 | 50 | 6000 | 350 |
| VHF060303HQ4N7□T | | 4.7 | 14 | 0.40 | 500 | 50 | 6000 | 350 |
| VHF060303HQ5N1□T | | 5.1 | 14 | 0.40 | 500 | 50 | 5500 | 350 |
| VHF060303HQ5N6□T | | 5.6 | 14 | 0.40 | 500 | 50 | 5000 | 350 |
| VHF060303HQ6N2□T | | 6.2 | 14 | 0.40 | 500 | 50 | 5000 | 300 |
| VHF060303HQ6N8□T | | 6.8 | 14 | 0.50 | 500 | 50 | 4500 | 300 |



补偿值表
The compensation value table

| 产品系列 Product series | 电感量范围 Inductance range | 测试频率 Test Frequency | 电感量范围 Inductance range | 补偿值 Compensation value |
|------------------------|---------------------------|------------------------|---------------------------|---------------------------|
| VHF060303HQ | Ls<33nH | 500MHz | Ls<3N6 | 0.25nH |
| | | | 3N6≤Ls<6N8 | 0.43nH |
| | | | 6N8≤Ls<9N1 | 0.50nH |
| | | | 9N1≤Ls<33N | 0.85nH |
| | Ls≥33nH | 300MHz | Ls≥33N | 0.85nH |

说明:

产品测试值=标称值-补偿值

如: VHF060303HQ1N0ST,其感量标称值是 1.0nH, 补偿值是 0.25nH, 则实际测试中心值是 0.75nH。

0.75nH (测试值) =1.0nH (标称值) -0.25nH (补偿值)。

Explain:

Test values=Nominal inductance-Compensation value

For example :VHF060303HQ1N0ST,The nominal inductance of its inductance is 1.0nH,the compensation value is 0.25nH,and the actual test center value is 0.75nH.

0.75nH (Test values) =1.0nH (Nominal inductance) -0.25nH (Compensation value) .



4 可靠性试验项目 Reliability Testing Items

| 序号 No. | 项目 Items | 要求 Requirements | 试验方法及备注 Test Methods and Remarks |
|-----------|---------------------------------------|---|---|
| 1 | 工作温度范围 Operating Temperature Range | -55℃~+125℃ | |
| 2 | 可焊性 Solder ability | 至少 95%端电极表面被焊锡覆盖。 At least 95% of terminal electrode should be covered with solder | 预热温度:120℃ ~ 150℃ 预热时间: 60s 焊料: (96.5%Sn/3.0%Ag/0.5%Cu) 焊锡 焊锡温度: 245℃ ±5℃ 浸锡深度:10mm 浸锡时间 : 5 ± 1s 浸渍到助焊剂约:3 ~ 5 s Preheating temperature:120℃ to 150℃ Preheating time: 60s Solder 96.5%Sn/3.0%Ag/0.5%Cu of the Sn solder. Solder temperature: 245 ± 5℃ Immersion tin depth:10mm Duration : 5 ± 1s Dip performance to a flux of about:3 ~ 5 s |
| 3 | 耐焊接热 Resistance to Soldering | 至少 95%的焊锡覆盖在端电极表面, 无可 见机械损伤。 电感量变化率如下: 陶瓷体电感 (H 料): ±10% 品质因素变化率 (陶瓷) ±20%, At least 95% of terminal electrode should be covered with solder. No mechanical damage. Inductance : H : change within ±10% Q value change(ceramic): within ±20% | 预热温度: 120℃ ~ 150℃ 预热时间: 60s 焊料: (96.5%Sn/3.0%Ag/0.5%Cu) 焊锡 浸锡温度: 260℃ ±5℃ 浸锡深度:10mm 浸锡时间 : 10 ± 1s 浸渍到助焊剂约:3 ~ 5 s Preheating temperature: 120℃ to 150℃ Preheating time: 60s Solder 96.5%Sn/3.0%Ag/0.5%Cu of the Sn solder. Solder temperature: 260℃ ± 5℃ Immersion tin depth:10mm Duration : 10 ± 1s Dip performance to a flux of about:3 ~ 5 s |

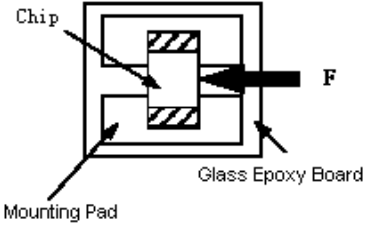
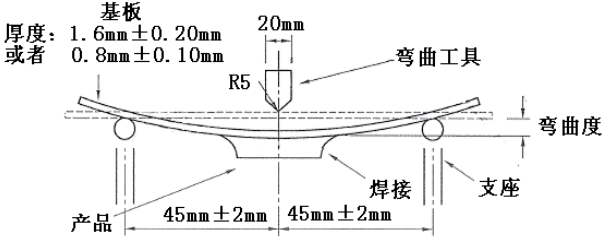

| 序号 No. | 项目 Items | 要求 Requirements | 试验方法及备注 Test Methods and Remarks |
|-----------|-----------------------------------|--|--|
| 4 | 端电极强度 Adhesion of electrode | 端电极与磁体不应受损，无可见机械损伤。 The termination and body should be no damage. | 施加力：0603 系列为 3N 保持时间：10±1S Applied force: 3N force for 0603 series. Keep time : 10±1S  |
| 5 | 耐低温 Low temperature resistance | 无可见机械损伤， 电感量变化率小于±10%， 品质因素变化率（陶瓷）小于±20%， No mechanical damage. Inductance change: within ±10% Q value change(ceramic): within ±20% | 测试温度：-55±2℃ +24 测试时间：1000-0 h Temperature: -55±2℃ +24 Testing time: 1000 ⁻⁰ h |
| 6 | 抗弯强度 Bending strength | 无可见机械损伤， No mechanical damage | 测试基板：玻璃环氧树脂基板 加压速度为 0.5mm/s, 弯度:2mm, 保持时间 20s±1s Testing board: glass epoxy-resin substrate For 0.5 mm/s compression speed, curvature: 2mm, hold time 20s±1s  |
| 7 | 振动 Vibration | 无可见机械损伤， 电感量变化率小于±10%， 品质因素变化率（陶瓷）小于±20%， No mechanical damage. Inductance change: within ±10% Q value change(ceramic): within ±20% | 振幅：1.5mm 测试时间：沿三个垂直方向各做 2 小时 频率范围：10Hz ~ 55Hz ~ 10Hz（1 分钟） Amplitude modulation: 1.5mm Test time: A period of 2h in each of 3 mutually perpendicular directions. Frequency range: 10Hz to 55Hz to 10Hz for 1min. |



| 序号 No. | 项目 Items | 要求 Requirements | 试验方法及备注 Test Methods and Remarks |
|-----------|------------------------------------|--|--|
| 8 | 耐高温 High temperature resistance | 无可见机械损伤, 电感量变化率小于±10%, 品质因素变化率(陶瓷)小于±20%, No mechanical damage. Inductance change: within ±10% Q value change(ceramic): within ±20% | 测试时间: $1000 \begin{smallmatrix} +24 \\ -0 \end{smallmatrix} \text{ h}$ 测试温度: $125^\circ\text{C} \pm 2^\circ\text{C}$ Testing time: $1000 \begin{smallmatrix} +24 \\ -0 \end{smallmatrix} \text{ h}$ Temperature: $125^\circ\text{C} \pm 2^\circ\text{C}$ |
| 9 | 恒定湿热 Static Humidity | 无可见机械损伤, 电感量变化率小于±10%, 品质因素变化率(陶瓷)小于±20%, No mechanical damage. Inductance change: within ±10% Q value change(ceramic): within ±20% | 湿度: 90%~95% RH, 温度: $60^\circ\text{C} \pm 2^\circ\text{C}$ 测试时间: $1000 \begin{smallmatrix} +24 \\ -0 \end{smallmatrix} \text{ h}$ Humidity: 90% to 95% RH Temperature: $60^\circ\text{C} \pm 2^\circ\text{C}$ Testing time: $1000 \begin{smallmatrix} +24 \\ -0 \end{smallmatrix} \text{ h}$ |
| 10 | 高温负载 High temperature load | 无可见机械损伤, 电感量变化率小于±10%, 品质因素变化率(陶瓷)小于±20%, No mechanical damage. Inductance change: within ±10% Q value change(ceramic): within ±20% | 施加电流: 额定电流 测试时间: $1000 \begin{smallmatrix} +24 \\ -0 \end{smallmatrix} \text{ h}$ 测试温度: $125^\circ\text{C} \pm 2^\circ\text{C}$ impose current: at room Testing time: $1000 \begin{smallmatrix} +24 \\ -0 \end{smallmatrix} \text{ h}$ Temperature: $125^\circ\text{C} \pm 2^\circ\text{C}$ |
| 11 | 温度冲击 Temperature Shock | 无可见机械损伤, 电感量变化率小于±10%, 品质因素变化率(陶瓷)小于±20%, No mechanical damage. Inductance change: within ±10% Q value change(ceramic): within ±20% | 温度: -55°C , 30±3 分钟 $+125^\circ\text{C}$, 30±3 分钟 循环次数: 100 Temperature: -55°C for 30±3min $+125^\circ\text{C}$ for 30±3min Number of cycles: 100 |

注: 以上要求测试电性能的项目, 应试验后在标准条件下放置 24 小时后测试。

Note: When there are questions concerning, measurement shall be made after 24±2hrs of recovery under the standard condition.



5 产品包装 Packaging

1) 编带图 Taping drawings

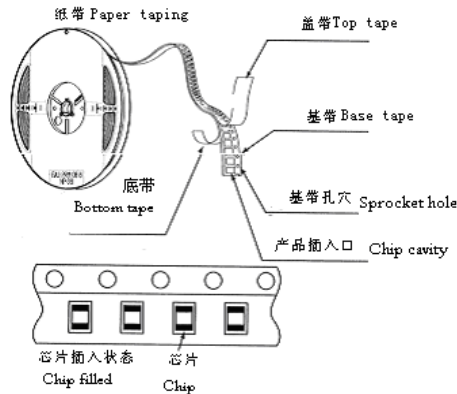

2) 卷盘尺寸 Reel dimensions (Unit: mm)

| 型号 Size | A | B | C | N | G |
|---------|---------|----------|----------|--------|---|
| CF-8 | 178±2.0 | 22.0±2.0 | 12.5±1.5 | 57±2.0 | 8 |
| | | | | | |

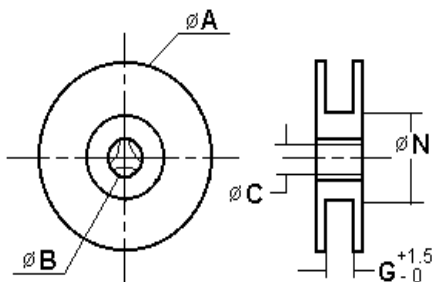

3) 导带及空格部分 Leader and blank portion

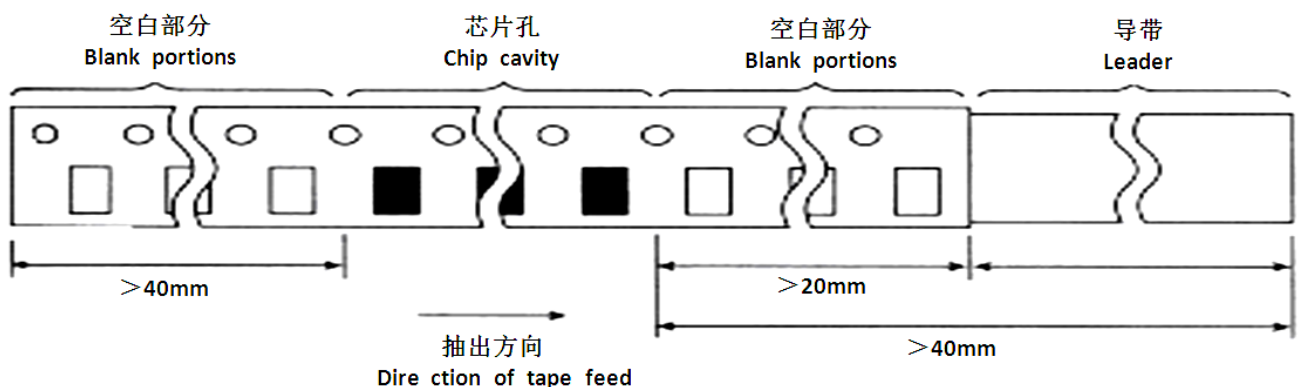

4) 编带尺寸 Taping dimensions (Unit: mm)

● 纸带 Paper tape

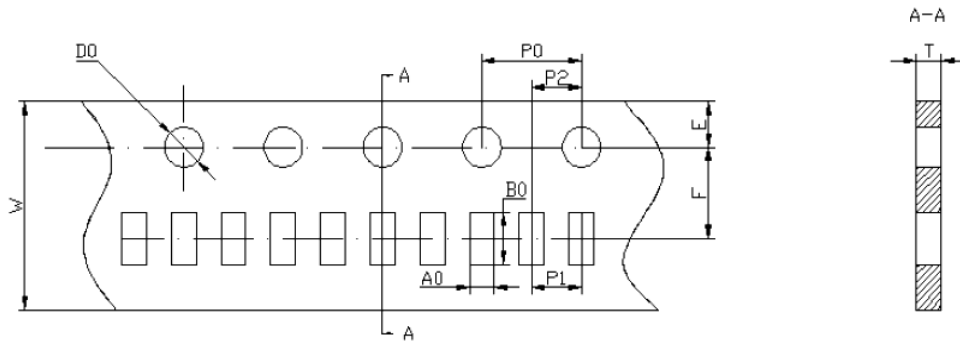

| 型号 Size | A0 | B0 | W | F | E | P1 | P2 | P0 | D0 | T |
|------------|---------------|---------------|---------|--------------|---------------|----------|----------|----------|---------------|---------------|
| 060303 | 0.35± 0.03 | 0.66± 0.03 | 8.0±0.1 | 3.5± 0.05 | 1.75± 0.05 | 2.0±0.05 | 2.0±0.05 | 4.0±0.05 | 1.55±0.0 5 | 0.42± 0.03 |

5) 剥离力检验 Peeling off force

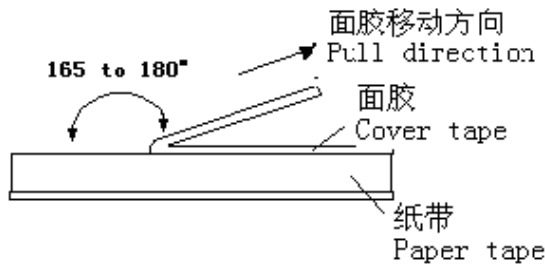

- ① 盖带的剥离力：沿面胶移动方向拉时要求剥离力为 0.1N~0.7N。
Peeling force should be 0.1~0.7N pulling in the direction of arrow.
- ② 剥离速度：300mm/min
Speed of peeling off: 300mm/min.
- ③ 在纸带剥落时，面胶不能有破损，不能粘纸带。
The cover bond should not be damaged and bond the tape when it peeled off.

6) 包装数量 (单位: 粒) Packaging number (Unit: Pcs)

| | |
|-----------|--------|
| 型号 Size | 060303 |
| 每卷数量 REEL | 15000 |
| 每盒数量 BOX | 150000 |
| 每箱数量 CASE | 900000 |

7) 标签粘贴位置 Label stick station

| 卷盘标签 Reel label | 纸盒标签 Carton label | 纸盒标签 Carton label | 外箱标签 Outer box label |
|-----------------|-------------------|-------------------|----------------------|
| | | | |



6 推荐焊接条件 Recommend Soldering Conditions

1) 焊接条件 Soldering Conditions

产品适用于回流焊 Products can be applied to reflow soldering.

① 焊接要求 Soldering conditions

- 预热时，产品表温与焊料温度的温差最大不允许超出 150℃，焊接完冷却时，产品表温与溶剂温度之间的温差最大不超过 100℃。预热不足有可能引发产品表面裂纹，从而导致产品品质下降。

Pre-heating should be in such a way that the temperature difference between solder and ferrite surface is limited to 150℃ max. Also cooling into solvent after soldering should be in such way that the temperature difference is limited to 100℃ max. Un-enough pre-heating may cause cracks on the ferrite, resulting in the deterioration of product quality.

- 产品要在以下画出的曲线允许的范围进行焊接。其它焊接条件可能引起产品电极的腐蚀。当焊接重复时，允许的时间为第一次做的累计时间。

Products should be soldered within the following allowable range indicated by the slanted line. The excessive soldering conditions may cause the corrosion of the electrode. When soldering is repeated, allowable time is the accumulated time.

2) 回流焊曲线 Reflow soldering profile

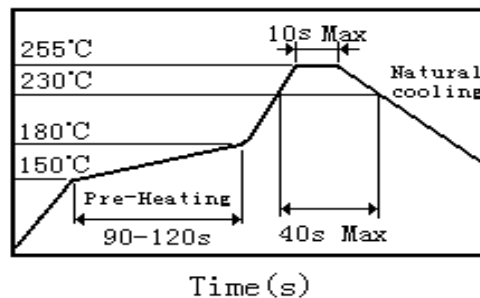

3) 手工焊接 Iron soldering

烙铁温度：350℃ (Max)

功率：最大为 30W

烙铁停留时间：<5S (注意不要将烙铁碰到产品端电极)。

Perform soldering at 350℃ on 30W max.

Soldering Time: < 5S (Take care not to apply the tip of the soldering iron to the terminal electrodes)。

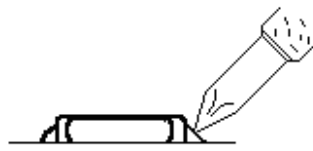

7 清洗 Cleaning

1) 清洗条件 Cleaning Conditions

清洗温度：60℃ (最高) Cleaning temperature : 60℃ max

清洗时间：1 分钟 (最少) Cleaning time: 1 minute min.

超声波功率：最大为 200W Ultrasonic output power: 200W max



8 存储要求 Storage Requirements

1) 存储期限 Storage period

距电感公司出厂检验时间 1 年内，产品可以使用检验时间可以通过包装外侧标记的检验号确认。若时间超过 1 年，应检查焊接性能后方可使用。

Products which inspected inductor company over 1 year ago should be examined and used, which can be Confirmed with inspection No. marked on the container. Solder ability should be checked if this period is exceeded.

2) 存储条件 Storage conditions

(1) 存放货物的库房应满足以下条件：温度：-10 ~ +40℃，相对湿度：30 ~ 70%。

(2) 禁止将产品保管在腐蚀性物质中，如硫磺、氯气或酸，否则将引起端头氧化，导致降低焊接性。

(3) 为了避免受潮气、灰尘等物质的影响，产品应保管于货架上。

(4) 产品保管在库房中，应避免热冲击、振动以及直接光照等等。

(5) 产品应密封包装。

(1) Products should be storage in the warehouse on the following conditions:

Temperature : -10~+40℃ Humidity: 30~70% relative humidity

(2) Don't keep products in corrosive gases such as sulfur, chlorine gas or acid , or it may case oxidization of Electrodes resulting in poor solder ability.

(3) Products should be stored on the palette for the prevention of the influence from humidity, dust and so on.

(4) Products should be stored in the warehouse without heat shock, vibration, direct sunlight and so on.

(5) Products should be stored under the airtight packaged condition.

9 ODS（消耗臭氧层物质）的使用情况 Usage Of ODS

1) 对于以下所列物质，我公司在生产过程中绝不使用。

ODS: CCl₄（四氯化碳）、HCFC 等。

For ODS listed below , we don't use in process.

ODS: CCl₄, HCFC, etc.

10 注意事项 Notes

(1) 若本次承认的为“整体无铅”产品，则表明该产品符合 RoHS 指令的要求。

(2) 本承认书保证我司产品作为一个单体时的质量情况，当我司产品被安装到贵司产品上时请保证贵司的产品已根据贵司的规范进行了有效评价和确认。

(3) 如果贵司对我司产品的试用已超过了本测试规范所界定的产品功能，对于此所引发的失效我司将不予保证。

(1) If the parcel label on product is "Unitary lead free" that indicate the products in accord with ROHS appointed requests.

(2) This product specification guarantees the quality of our product as a single unit, Please make sure that your product has been evaluated and confirmed against your specifications when our product is mounted to your product.

(3) We can't warrant against failure caused by any use of our product that deviates from the intended use as described in this product specification.

X-ON Electronics

Largest Supplier of Electrical and Electronic Components

Click to view similar products for [Fixed Inductors](#) category:

Click to view products by [Fenghua Advanced](#) manufacturer:

Other Similar products are found below :

[CR32NP-100KC](#) [CR32NP-151KC](#) [CR32NP-180KC](#) [CR32NP-181KC](#) [CR32NP-1R5MC](#) [CR32NP-390KC](#) [CR32NP-3R9MC](#) [CR32NP-680KC](#) [CR32NP-820KC](#) [CR32NP-8R2MC](#) [CR43NP-390KC](#) [CR43NP-560KC](#) [CR43NP-680KC](#) [CR54NP-181KC](#) [CR54NP-470LC](#) [CR54NP-820KC](#) [CR54NP-8R5MC](#) [70F224AI](#) [MGDQ4-00004-P](#) [MHL1ECTTP18NJ](#) [MHQ1005P10NJ](#) [MHQ1005P1N0S](#) [MHQ1005P2N4S](#) [MHQ1005P3N6S](#) [MHQ1005P5N1S](#) [MHQ1005P8N2J](#) [PE-51506NL](#) [PE-53601NL](#) [PE-53602NL](#) [PE-53630NL](#) [PE-53824SNLT](#) [PE-92100NL](#) [PG0434.801NLT](#) [PG0936.113NLT](#) [9220-20](#) [9310-16](#) [PM06-2N7](#) [PM06-39NJ](#) [A01TK](#) [1206CS-471XJ](#) [HC2LP-R47-R](#) [HC2-R47-R](#) [HC3-2R2-R](#) [HCF1305-3R3-R](#) [1206CS-151XG](#) [RCH664NP-140L](#) [RCH664NP-4R7M](#) [RCH8011NP-221L](#) [RCP1317NP-332L](#) [RCP1317NP-391L](#)