



F&F Filipowski sp. j.
Konstantynowska 79/81, 95-200 Pabianice, POLAND
phone/fax (+48 42) 215 23 83 / (+48 42) 227 09 71
www.fif.com.pl; e-mail: biuro@fif.com.pl

CKF-319 TRMS

Phase loss and phase
sequence sensor



Do not dispose of this device in the trash along with other waste!

According to the Law on Waste, electro coming from households free of charge and can give any amount to up to that end point of collection, as well as to store the occasion of the purchase of new equipment (in accordance with the principle of old-for-new, regardless of brand). Electro thrown in the trash or abandoned in nature, pose a threat to the environment and human health.



Purpose

The CKF-319 phase loss and phase sequence microprocessor sensor without neutral wire is designed to protect electric motor powered from the three-phase network in following cases:

- » voltage loss in at least one phase;
- » voltage drop in at least one phase below 150 V;
- » voltage increase in at least one phase above 280 V;
- » voltage asymmetry between phases above the set value;
- » incorrect phase sequence.



The sensor correctly measures the true rms value of the voltage (TrueRMS), even when the power supply voltage is (disturbed) distorted.

Functioning

The correct power supply voltage is indicated by a green LED. Voltage drop below 150 V or increase above 880 V for at least one phase or voltage asymmetry above the set value is signaled by the green LED going off.

Both of the above anomalies (exceeding the voltage threshold, asymmetry) cause the relay of the device to be switched off and, as a result, the motor to be disconnected.

Disconnection is carried out with a set delay in order to avoid accidental shutdowns in case of temporary interferences in the power supply network.

If the voltage drops below 150 V or rises above 280 V, the disconnection is carried out after 1 sec. The countdown to shutdown is indicated by the green diode flashing.

The relay is switched on again automatically when the correct network parameters return (voltage hysteresis is approx. 5 V).

If the phase sequence is changed before the sensor causing an unwanted change of the motor rotation direction, the sensor will not allow the motor to start (the red LED is on and the relay is off). Re-activation is possible after the correct phase sequence has been restored.









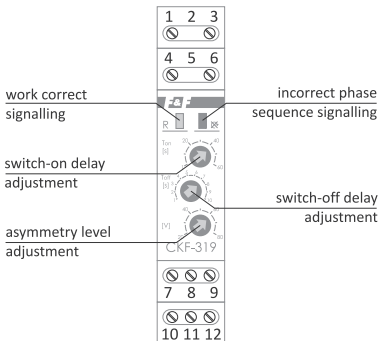

In case of incorrect connection of the input wires (phase in place of the neutral wire), the LEDs flash in green-red sequence, indicating a connection error (in this case, the output relay will not be switched on either).



Long-term operation with an incorrectly connected neutral wire can cause irreparable damage to the controller.

Front panel



Signalling	Description
<p>R </p> <p></p>	<p>Correct network parameters, the relay is on</p>
<p>R </p> <p></p>	<p>Countdown to switch-on or switch-off of the relay (depending on the current state of the output)</p>
<p>R </p> <p></p>	<p>Asymmetry or exceeding of the voltage threshold. Relay switched off (voltage value of any of the phases below 150 V or above 280 V or asymmetry above the set value)</p>
<p>R </p> <p></p>	<p>Incorrect phase sequence. (The system detected an incorrect phase rotation sequence on the input terminals)</p>
<p>R </p> <p></p>	<p>Incorrect connection of neutral wire (phase wire swapped with the neutral wire on the device terminals)</p>

Legend:

R – green LED;  – red LED

Voltage waveforms

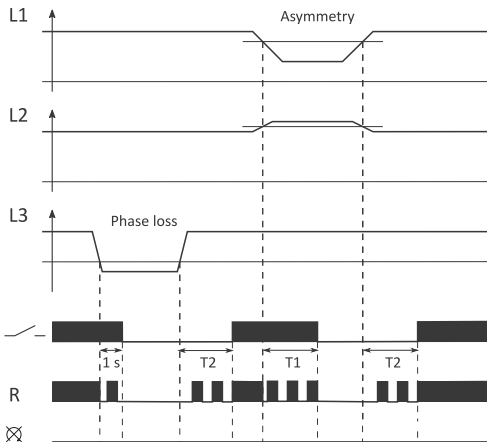

Legend:

$T1 = 1 \div 10 \text{ s}$

$T2 = 1 \div 60 \text{ s}$

If a voltage drop below 150 V or a rise above 280 V is detected, the relay will be switched off with a delay of 1 s. In this case, both LEDs will be switched off. If the phase voltages return to normal values, the relay will be switched on after T2 time.

If a voltage asymmetry between phases occurs, the relay will be switched off after T1 time. The green LED [R] will flash until the relay is switched off (time T1). If the phase voltages return to normal values, the relay will be switched on after T2 time. The green LED [R] will flash until the relay is switched switch (time T2).

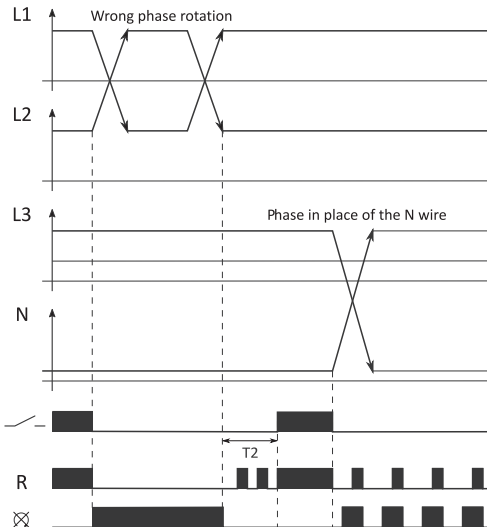

Legend:

$T_2 = 1 \div 60 \text{ s}$

If the wrong phase rotation sequence is detected at the input terminals of the device, the relay will be switched off immediately. The red LED will be on to indicate a phase sequence error. When the correct phase sequence returns, the relay will be switched on with a delay of T_2 . The green LED [R] will flash until the relay is switched switch (time T_2).

If the neutral wire is connected to the wrong terminal, the relay will not be switched on and the LEDs will flash in following order: red, green.

Mounting

1. Check the correct operation of the motor (direction of rotation).
2. Disconnect the power supply.
3. Fix the sensor on a rail in the control box.
4. Connect the phases in sequence to terminals 1, 6, 4. To terminal 3 connect N-wire.
5. Connect the power supply of the switching contactor coil in series to terminals 8-9 or 11-12.
6. Set the desired values using the dials.
7. Switch on the power supply.
8. Green LED is on – correct voltage asymmetry and phase voltage value – the motor can be started.
9. Red LED is on – incorrect phase sequence.
10. Disconnect the power supply.
11. Swap the 2 phases (for example, L2 with L3).
12. Switch on the power supply – the motor can be started
13. In any other case than those described in points 8 and 9, see the signaling table (page 4).

Wiring diagram

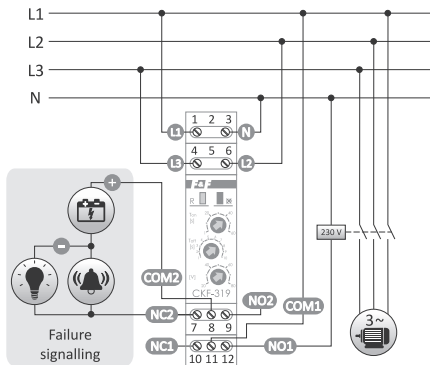

Contacts configuration

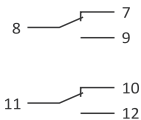



The changeover contact of the relay allows to connect a visual or audible signalling system that informs about the relay activation, which means switching off the motor.

Technical data

power supply	3×400 V+N
contact	separated 2×NO/NC
maximum load current (AC-1)	2×8 A
signaling of correct power supply	2×LED
minimum phase voltage	150 V
maximum phase voltage	280 V
effective voltage unbalance	20÷80 V
voltage hysteresis	5 V
deactivation delay on asymmetry	1÷10 s
deactivation delay in no phase	1 s
activation delay	1÷60 s
power consumption	1.6 W
working temperature	-25÷40°C
terminal	
wire	2.5 mm ² screw terminals
cable	2.5 mm ² screw terminals
tightening torque	0.4 Nm
dimensions	1 module (18 mm)
mounting	on TH-35 rail
ingress protection	IP20

Warranty

The F&F products are covered by a warranty of the 24 months from the date of purchase. Effective only with proof of purchase. Contact your dealer or directly with us.

CE declaration

F&F Filipowski sp. j. declares that the device is in conformity with the essential requirements of The Low Voltage Directive (LVD) 2014/35/EU and the Electromagnetic Compatibility (EMC) Directive 2014/30/UE. The CE Declaration of Conformity, along with the references to the standards in relation to which conformity is declared, can be found at www.fif.com.pl on the product page.

General work safety conditions

- » Please read the instructions carefully before installation.
- » The device should be installed and operated by qualified personnel who are familiar with its design, operation, and associated risks.
- » Do not install a sensor that is damaged or incomplete.
- » The user is responsible for proper grounding of the system, proper selection, installation, and efficiency of other devices connected to the sensor, including safety devices such as over-current, residual current, and overvoltage circuit breakers.
- » Before connecting the power supply, make sure that all cables are connected correctly.
- » It is essential to observe the operating conditions of the sensor (supply voltage, humidity, temperature).
- » To avoid electric shock or damage to the sensor, turn off the power supply whenever the connection is changed.
- » Do not make any changes to the unit yourself. Doing so can result in damage to or improper operation of the device, which in turn can pose a threat to people operating it. In such cases, the manufacturer is not responsible for the resulting events and may refuse the provided warranty in the event of a complaint.

«F&F»[®]

X-ON Electronics

Largest Supplier of Electrical and Electronic Components

Click to view similar products for [Industrial Relays](#) category:

Click to view products by [F&F](#) manufacturer:

Other Similar products are found below :

[6-1617801-8](#) [6-1618107-9](#) [7-1618273-3](#) [EV250-6A-01](#) [FCA-125-CX8](#) [FCA-325-159](#) [FCA-410-138](#) [8000-S3121](#) [8-1618273-6](#) [8-1618393-1](#)
[GCA63A220VAC60HZ](#) [GCA63A277VAC60HZ](#) [GCA63A600VAC60HZ](#) [1-1672275-3](#) [1-1833005-4](#) [H-16/S1](#) [A711Z](#) [H-8C](#) [H-8/S11](#) [H-8/S68](#) [ACC530U20](#) [ACC730U30](#) [RF303ZM4-12](#) [DH18DA](#) [1423675-8](#) [AR4-15F13-C01](#) [AR7-41F11](#) [AVR907](#) [15732A200](#) [B07B032AC1-0329](#) [B329](#) [B490A](#) [1618279-1](#) [BHR124Y](#) [1810DDB-SX](#) [P30C42A12D1-120](#) [2-1617748-6](#) [2-1618375-1](#) [2-1618396-6](#) [2-1618398-1](#)
[JMAPD-5XL](#) [JMGACD-5M](#) [JMGSC-5LW](#) [JMGSCD-5L](#) [PBO-18A1218](#) [PBO-40A3040](#) [K8DSPH1200480VAC](#) [KA-3C-12A](#) [2307497](#) [K-D4A-300M](#)