



Programmable Relay User's Manual

Applied to FLC12 & FLC18



www.fif.com.pl

Contents

- ✧ Introduction
- ✧ Getting started
- ✧ Installation and wiring
- ✧ Programming FLC
- ✧ Configuring & software
- ✧ Applications
- ✧ Technical data

Introduction

Congratulations with your FLC provided by F&F.

The FLogic FLC is a compact and expandable CPU replacing mini PLCs, multiple timers, relays and counters.

The FLC perfectly fits in the space between timing relays and low-end PLCs. Each CPU incorporates not only a real-time clock and calendar, but also provides support for optional expansion I/O modules to enhance control and monitoring applications. Data adjustments can easily be performed via the keypad, the LCD display, or through the F&F-to-use FLC soft. DIN-rail and panel-mounted options are both available, offering full flexibility to the various installation needs of your application.

The FLC is available in 12V and 24V DC versions, making it the ideal solution for relay replacement, or simple control applications as building and parking lot lighting, managing automatic lighting, access control, watering systems, pump control, ventilation systems, home automation and a wide field of other applications demanding low cost to be a primary design issue.

We strongly recommended taking the time to read this manual, before putting the FLogic FLC to work. Installation, programming and use of the unit are detailed in this manual. The feature-rich FLogic FLC provides a for off-line operation mode, allowing full configuration and testing prior to in-field service commissioning. In reviewing this manual you will discover many additional advantageous product properties, it will greatly simplify and optimize the use of your FLC.

Valid range of this manual

The manual applies to devices of FLC12 & FLC18 series modules.

Safety Guideline

This manual contains notices you have to observe in order to ensure your personal safety, as well as to prevent damage to property. The notices referring to your personal safety are highlighted in the manual by a safety alert symbol; notices referring to property damage only have no safety alert symbol. The notices shown below are graded according to the degree of danger.

Caution

Indicates that death or severe personal injury may result if proper precautions are not taken

Caution

With a safety alert symbol indicates that minor personal injury can result if proper precautions are not taken.

Caution

Without a safety alert symbol indicates that property damage can result if proper precautions are not taken.

Attention

Indicate that an unintended result or situation can occur if the corresponding notice is not taken into account.

If more than one degree of danger is present, the warning notice representing the highest degree of danger will be used. A notice warning of injury to persons with a safety alert symbol may also include a warning relating to property damage.

Qualified Personnel

The device/system may only be set up and used in conjunction with this documentation. Commissioning and operation of a device/system may only be performed by qualified personnel. Within the context of the safety notices in this documentation qualified persons are defined as persons who are authorized to commission, ground and label devices, systems and circuits in accordance with established safety practices and standards. Please read the complete operating instructions before installation and commissioning.

F&F does not accept any liability for possible damage to persons, buildings or machines, which occur due to incorrect use or from not following the details.

Prescribed Usage

Note the following:

Warning

This device and its components may only be used for the applications described in the catalog or the technical description, and only in connection with devices or components from other manufacturers which have been approved or recommended by F&F. Correct, reliable operation of the product requires proper transport, storage, positioning and assembly as well as careful operation and maintenance.

Contents

Contents.....	1
Chapter 1 General Introduction to FLC	9
1.1 Overview.....	9
1.2 Highlight feature.....	9
Chapter 2 Hardware models and resources.....	11
2.1 Hardware model selection.....	11
2.2 Structure & dimension.....	11
Chapter 3 Installing/removing FLC	14
3.1 DIN rail mounting.....	14
3.2 Wall-mounting.....	16
3.3 Wiring FLC	18
3.3.1 Connecting the power supply.....	19
3.3.2 Connecting FLC inputs.....	19
3.3.3 Connecting FLC outputs	22
3.3.4 Communication port	25
Chapter 4 Parameters modification HMI operation.....	28
4.1 Overview of FLC menu.....	28
4.2 LCD panel instruction.....	29
4.3 Select function page.....	32
4.3.1 How to switch Run/Stop.....	34
4.3.2 Set parameter.....	34
4.3.3 Set password.....	37
4.3.4 How to set address of CPU and expansion module.....	41
4.3.5 Set LCD (backlight and Contrast).....	44
4.3.6 Set communication parameters.....	46
4.3.7 Modification of System Time.....	48
Chapter 5 Configuring & Programming software.....	50
5.1 FLogic FLC Functions.....	60
5.2 General Input & Output functions.....	51
5.2.1 Inputs.....	51
5.2.2 Cursor keys.....	52
5.2.3 Outputs.....	52
5.2.4 Permanent logical levels HI and LO.....	53
5.2.5 Panel Key.....	53
5.2.6 Shift register bits.....	54
5.2.7 Analog inputs.....	54
5.2.8 F (Digital flag).....	55
5.2.9 AF (Analog flag).....	56
5.3 Basic functions list – GF.....	56
5.3.1 AND.....	57
5.3.2 AND with edge evaluation.....	58

5.3.3 NAND.....	59
5.3.4 NAND with edge evaluation.....	60
5.3.5 OR.....	60
5.3.6 NOR.....	61
5.3.7 XOR.....	62
5.3.8 NOT.....	63
5.3.9 Boolean Function.....	63
5.4 Basics on special functions.....	64
5.4.1 Designation of the inputs.....	65
5.4.2 Time response.....	66
5.4.3 Backup of the real-time clock.....	66
5.4.4 Retentivity.....	66
5.4.5 Parameter protection.....	67
5.4.6 Calculating the gain and offset of analog values.....	67
5.5 Special functions list – SF.....	69
5.5.1 On-delay.....	73
5.5.2 Off-delay.....	74
5.5.3 On-/Off-delay.....	76
5.5.4 Retentive on-delay.....	77
5.5.5 Wiping relay (pulse output).....	78
5.5.6 Edge triggered wiping relay.....	80
5.5.7 Asynchronous pulse generator.....	81
5.5.8 Random generator.....	82
5.5.9 Stairway lighting switch.....	84
5.5.10 Multiple function switch.....	86
5.5.11 Weekly timer.....	87
5.5.12 Yearly timer.....	90
5.5.13 Up/Down counter.....	95
5.5.14 Hours counter.....	97
5.5.15 Threshold trigger.....	99
5.5.16 Latching relay.....	101
5.5.17 Pulse relay.....	102
5.5.18 Message text.....	103
5.5.18.1 How to change parameters of blocks in displayed message?.....	111
5.5.19 Softkey.....	113
5.5.20 Shift register.....	115
5.5.21 Analog comparator.....	116
5.5.22 Analog threshold trigger.....	119
5.5.23 Analog amplifier.....	121
5.5.24 Analog value monitoring.....	122
5.5.25 Analog differential trigger.....	124
5.5.26 Analog multiplexer.....	126
5.5.27 System cover.....	128
5.5.28 Pulse Width Modulator (PWM).....	129

5.5.29 Analog Ramp.....	132
5.5.30 Analog Math.....	134
5.5.31 Analog math error detection.....	136
5.5.32 Modbus Read.....	138
5.5.33 Modbus Write.....	143
5.5.34 Data latching relay.....	147
5.5.35 PI controller.....	149
5.5.38 Word to Bit.....	160
5.5.39 Bit to Word.....	161
5.5.40 Stopwatch.....	162
5.5.41 Analog filter.....	164
5.5.42 Max/Min.....	165
5.5.43 Average value.....	168
5.5.45 Comport Status.....	170
5.5.46 Astronomical clock.....	173
5.5.47 Cam Control.....	175
5.5.48 Angular Cam Timer.....	176
5.5.49 Pumps Management.....	177
5.5.50 Defrost.....	179
5.5.51 Comparison of 2 values.....	180
5.5.52 Multicompare.....	181
5.5.53 Compare in zone.....	182
5.5.54 Conversion Word bits.....	183
5.5.55 Conversion bits Word.....	184
5.5.56 Demultiplexer.....	184
5.5.57 Multiplexing.....	185
5.5.58 Multiplexer.....	186
5.5.59 Square Boot.....	186
5.5.60 Sin Cos.....	187
5.5.61 Absolute Humidity.....	188
5.6 FLC Logic Soft.....	189
5.7 Main Functions.....	190
5.8 Operation Instructions.....	190
5.8.1 Menu Bar.....	191
5.8.1.1 File.....	191
5.8.1.2 Edit.....	192
5.8.1.3 Tools.....	192
5.8.1.4 SMS.....	193
5.8.1.5 View.....	194
5.8.1.6 Help.....	194
5.8.2 Toolbar.....	194

5.8.3 Programming Toolbar.....	195
5.8.4 Simulation Tool and status window.....	196
5.9 Basic Operation.....	199
5.9.1 Open File.....	199
5.9.1.1 Open New File.....	199
5.9.1.2 Open Existed Document.....	201
5.9.2 Edit Function Diagram Program.....	202
5.9.2.1 Place Function Block.....	202
5.9.2.2 Edit Property of Function Block.....	202
5.9.2.3 Setup link.....	203
5.9.2.4 Delete Function Block or Delete Link.....	205
5.9.2.5 Change block index.....	206
5.10 Simulation Running.....	206
5.11 Save and Print.....	208
5.12 Modify Password and transfer the Program.....	209
5.13 On-line monitoring/test circuit program.....	211
Chapter 6 Applications.....	217
6.1 Dual-function switch.....	217
6.1.1 Standard solution	218
6.1.2 The scheme of FLC	219
6.2 Automatic gate.....	220
6.2.1 Standard solution.....	221
6.2.2 The scheme of FLC	222
6.3 Ventilation system.....	224
6.3.1 Standard solution.....	224
6.3.2 The scheme of FLC	225
6.4 Factory door.....	227
6.4.1 Standard solution.....	227
6.4.2 The scheme of FLC	228
6.5 Daylight lamp system.....	230
6.5.1 Standard solution.....	231
6.5.2 The scheme of FLC	232
6.6 Rainwater pump.....	233
6.6.1 Standard solution.....	235
6.6.2 The scheme of FLC	235
Chapter 7 Modbus function code and Register addresses.....	237
7.1 FLC modbus function code	237
7.2 Register addresses of FLC (FLogic).....	237
Appendix.....	244
A Technical data.....	244
A.1 General technical data.....	244
A.2 Switching capacity and service life of the relay outputs.....	254

Chapter 1 General Introduction to FLC

1.1 Overview

FLogic FLC is a universal logic module made by F&F.

FLC, a compact, expandable CPU that can replace mini PLC, multiple timers, relays and counters, Splitting the difference between a timing relay and a low-end PLC, Each CPU has a real-time clock and calendar, and supports optional expansion I/O modules to enhance your control and monitoring applications. Data adjustments can be done via the on-board keypad and LCD display, or with FLC Logic Soft. It can be either DIN-rail or panel mounted, depending upon the needs of your application, and it is available in 12V and 24V DC versions, and it is the ideal solution for relay replacement applications, simple control applications such as building and parking lot lighting, managing automatic lighting, access control, watering systems, pump control, or ventilation systems in factory, and home automation and applications in which cost is a primary design issue.

1.2 Highlight feature

- 4-lines, 16-characters per line, backlight display.
- Multiple value display and input via keypad and LCD display.
- 70 kinds of function Blocks can be used in a circuit program in maximum
- Standard Modbus RTU/ASCII/TCP communication protocol supported.
- It's optional for FLC to act as slave or master in certain Modbus communication network.
(easy connect to other factory touch screen by RS232 cable, RS485 module)
- Expandable up to 16 linked IO expansion modules reaching 282 I/O points in maximum
- Optional RS232, RS485
- Multiple channels analog inputs available with DC 0-10V signal, PT100 signal & 0/4....20mA.
- Default Real Time Clock (RTC) and summer/winter timer is available
- Backup at Real Time Clock (RTC) at 25°C: 20 days
- 4 channels high-speed counting
- Pre-configured standard functions, e.g. on/ off-delays, pulse relay and softkey
- 2 PWM channels (10 kHz in maximum)

- USB communication download cable with photo-electricity isolation
- Programmable capability up to 1024 function blocks (FLC18); 512 function blocks (FLC12)
- Mounting via modular 35mm DIN rail or screw fixed mounting plate
- Kinds of analog signals process capacity (DC 0..10V ,0/4...20mA and PT100 probe inputs and DC 0..10V and 0/4...20mA outputs)
- Low cost

Some of the things FLC can do for you?

The FLogic FLC provides solutions for commercial, industrial, building and domestic applications such as lighting, pumping, ventilation, shutter operations or in switching cabinets. The application field is widespread and these are just a few to mention. Using the RS485 bus allows the user to realize various extensive (real-time monitoring and control applications).

Chapter 2 Hardware models and resources

2.1 Hardware model selection

FLC12 CPU Units (None expandable)								
Model	Expansion	Supply voltage	Inputs	Outputs	High-speed count	PWM	HMI	RTC
FLC12-8DI-4R	no	DC12-24V	4(0...10V)+4 digital	4 relays (10A)	4(15-18)(60KHZ)	no	yes	yes

FLC18 CPU Units (Expandable)								
Model	Expansion	Supply voltage	Inputs	Outputs	High-speed count	PWM	HMI	RTC
FLC18-12DI-6R	yes	DC12-24V	6(0...10V)/6digital al+6 digital	6 relays (10A)	4(19-1C)(60KHZ)	no	yes	yes

Expansion Modules (For FLC 18 series)			
Model	Supply voltage	Inputs	Outputs
FLC18E-8DI-8R	DC12-24V	4digital+4analog(0...10V)/digital	4 relays (10A) +4 relays(3A)
FLC18E-8D-8TN	DC12-24V	4digital+4analog(0...10V)/digital	8 transistors(PNP)(0.3A)
FLC18E-3PT100	DC12-24V	3 Channels PT100, resolution: 0.5°, temperature range : -50℃- 200℃	none
FLC18E-2AQ-VI	DC12-24V	none	2 Channels (DC 0...10V/0...20mA)
FLC18E-4AI-I	DC12-24V	4 Channels (0/4...20 mA), Current Signal	none
FLC18E-RS485	DC12-24V	isolated 485 converter, used to bring out the terminals of RS485 port built-in PR-18&PR-24 series CPU for connection with third party devices.	
Accessories			
FLC-USB	USB communication module /download cable between PC and FLC CPU units		

2.2 Structure & dimension

1. Standard FLC12 series with LCD model:

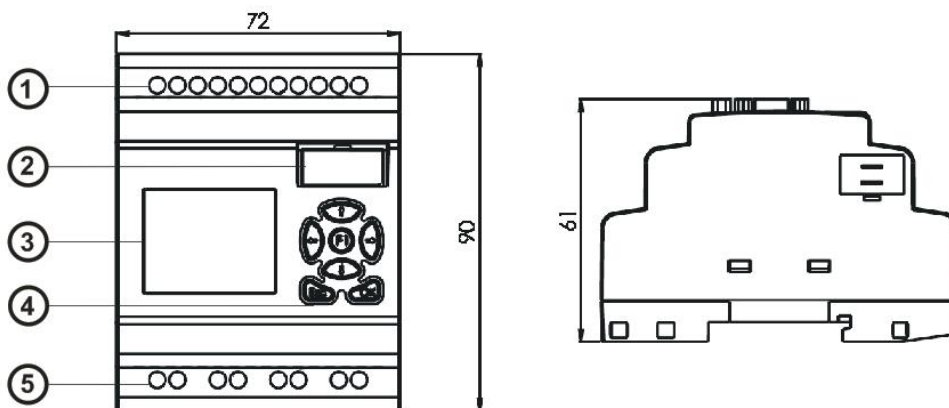

1.Power supply&Input terminals 2. Program Port 3.HMI/LCD panel 4.keypad 5.Output terminals

2. FLC18 series model:

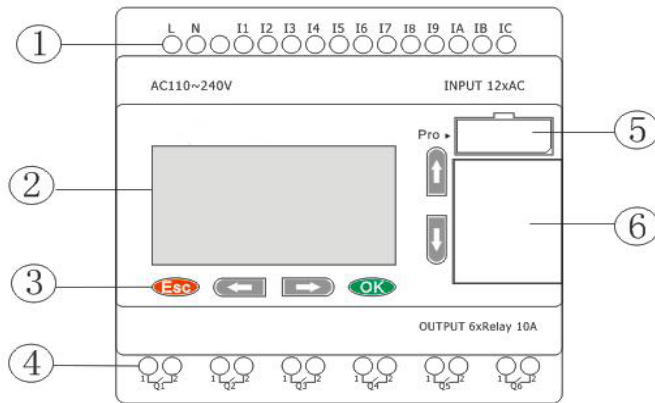

- 1.Power supply&Input terminals 2.HMI/LCD panel 3.keypad 4.Output terminals 5. Program Port 6.Extension port

Dimensions of FLC18:

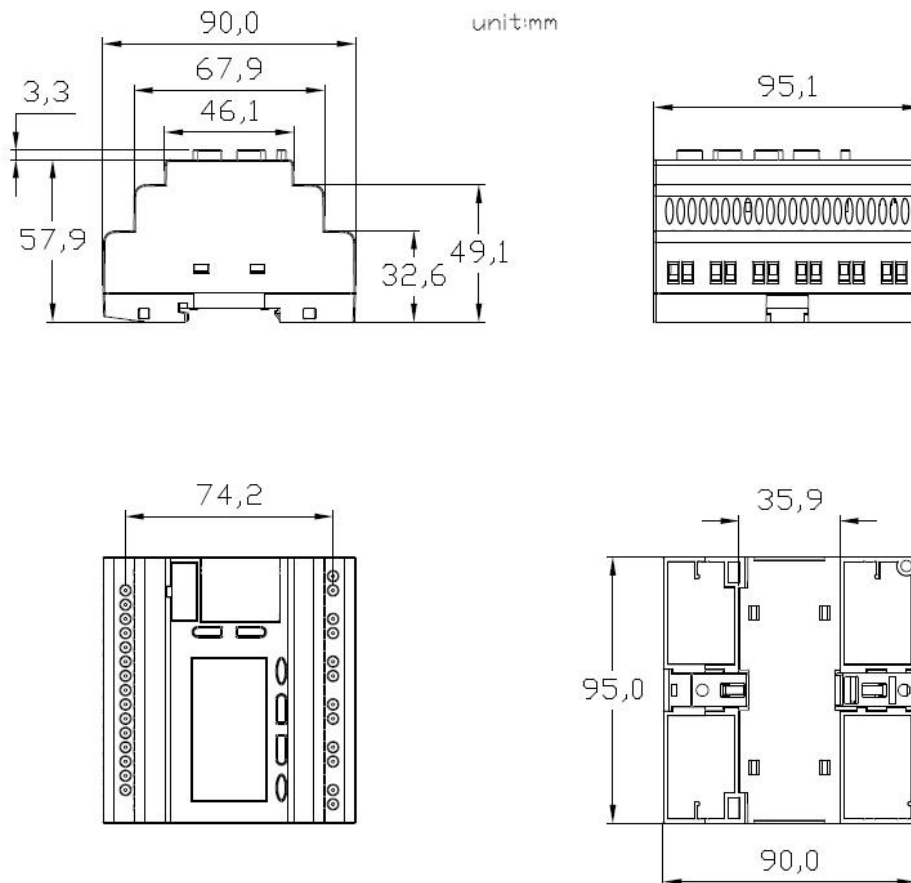

3. FLC18E extension module:

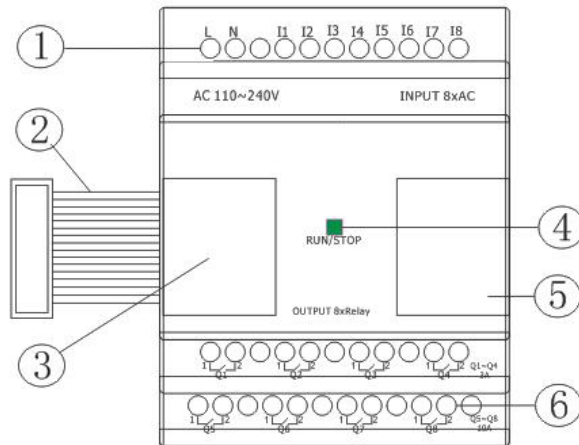

- 1. Power supply&Input terminals
- 2. Connection cable between CPU and extension (Detached)
- 3.Extension port (left)
- 4. RUN/STOP indicator
- 5. Extension port (right)
- 6. Output terminals

Dimensions of FLC18E:

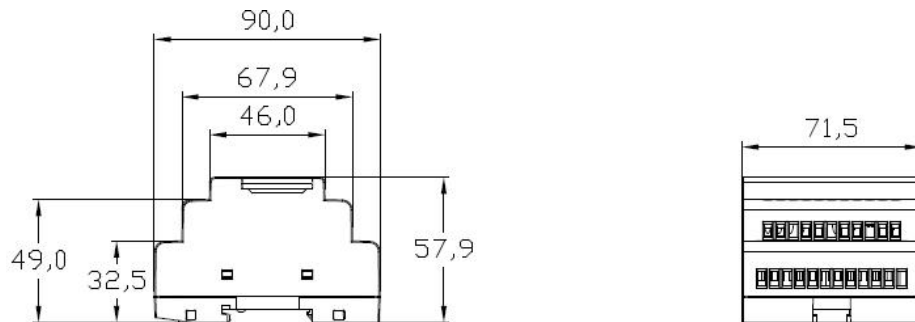

Chapter 3 Installing/removing FLC

Dimensions

The FLC installation dimensions are compliant with DIN 43880.

FLC can be snap-mounted to 35 mm DIN rails to EN 50022 or on the wall.

FLC width:

- FLC18E Series CPU has a width of 95mm.
- FLC18E expansion modules have a width of 72mm.
- FLC12 Series CPU has a width of 72mm

Note

The figure below shows you an example of the installation and removal of an FLC18 CPU and one expansion module of FLC18E.

Warning



Always switch off power before you "remove" and "insert" an expansion module.

3.1 DIN rail mounting

Mounting

How to mount a FLC module and an expansion module onto a DIN rail:

1. Hook the FLC Basic module onto the rail.
2. Push down the lower end to snap it on. The mounting interlock at the rear must engage.

3. Hook the FLC expansion module onto the rail
4. Slide the module towards the left until it touches the FLC CPU.
5. Push down the lower end to snap it on. The mounting interlock at the rear must engage.
6. Remove the plastic cover in the expansion port of CPU and expansion module.
7. Plus the connector on the flat cable to CPU.



Repeat the expansion module steps to mount further expansion modules.

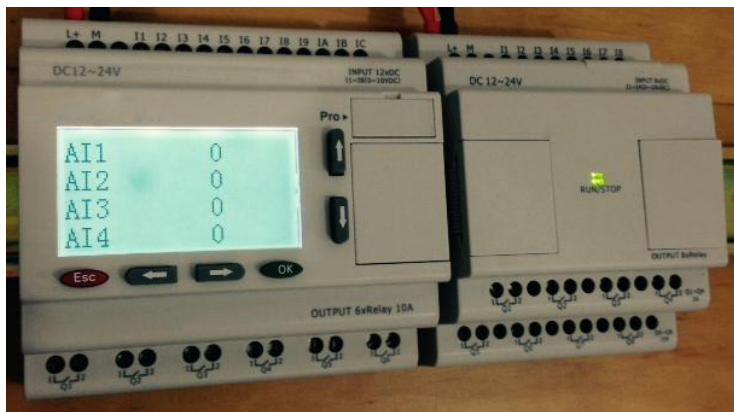

Note: If you need install the expansion and CPU on different rows, you need order the longer flat connection which is used to connected with CPU, the longest distance can be 200 meters between the CPU and the end expansion module.

Removal

To remove FLC:

..... if you have installed only one FLC Basic:

1. Insert a screwdriver into the eyelet at the bottom of the slide interlock and move the latch downward.
2. Swing the FLC Basic off the DIN rail.

..... if you have connected at least one expansion module to FLC Basic:

1. Remove the connector on the flat cable
2. Slide the expansion module off towards the right.
3. Insert a screwdriver into the eyelet at the bottom of the slide interlock and lever it

downward.

4. Swing the expansion module off the profile rail.

Repeat steps 1 to 4 for all other expansion modules.

3.2 Wall-mounting

For wall-mounting, first slide the mounting slides on the rear side of the devices towards the outside. You can now wall-mount FLC by means of two mounting slides and two ØM4 screws (tightening torque 0.8 to 1.2 Nm).

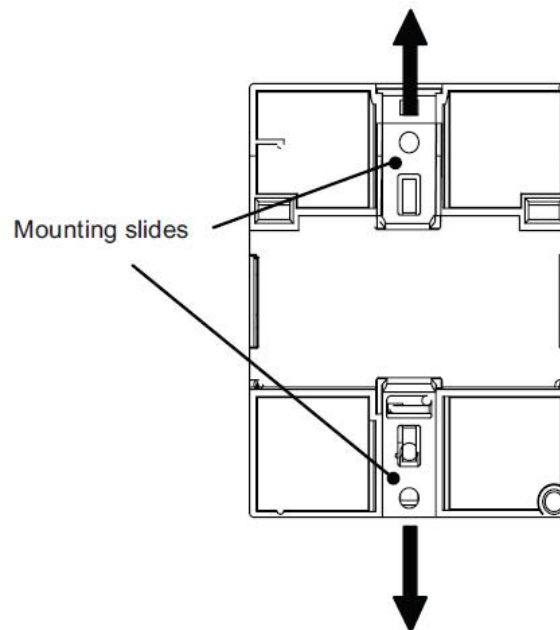

Drilling template for wall-mounting

Before you can wall-mount FLC, you need to drill holes using the template shown below.

All dimensions in mm

Bore hole for Ø M4 screw, tightening torque 0.8 to 1.2 Nm

1. FLC CPU

FLC12 CPU

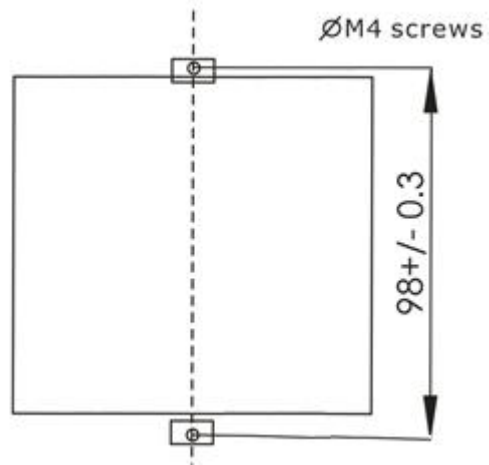

FLC18 series:

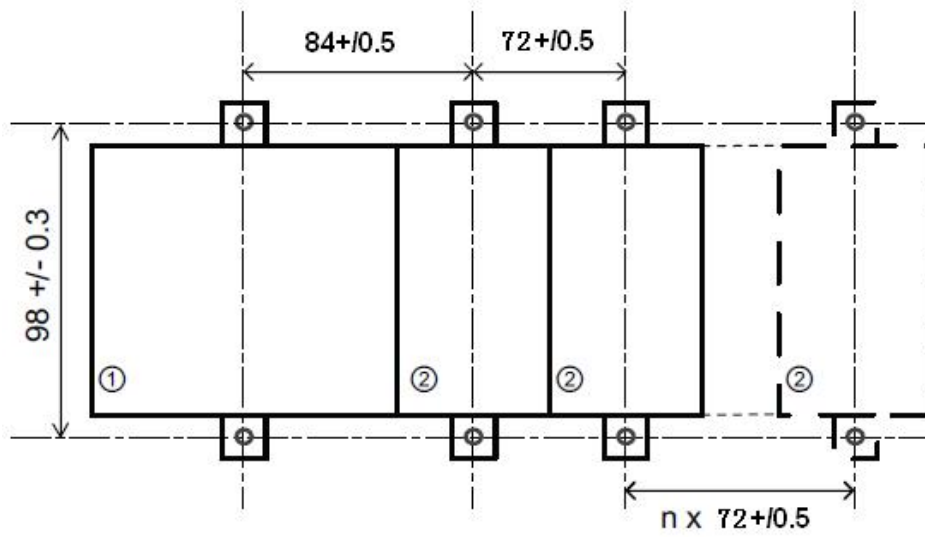

3.3 Wiring FLC

Wire the FLC using a screwdriver with a 3-mm blade.

You do not need wire ferrules for the terminals. You can use conductors with cross-sections of up to the following thicknesses:

- 1 x 2.5 mm²
- 2 x 1.5 mm² for each second terminal chamber
- Tightening torque: 0.4.. .0.5 N/m or 3. ..4 lbs/in

Note

Always cover the terminals after you have completed the installation. To protect FLC adequately from impermissible contact to live parts, local standards must be complied with.

3.3.1 Connecting the power supply

The FLC12, FLC18 versions can be operated with a 12 or 24 V DC power supply.

Note

A power failure may cause an additional edge triggering signal.

Data of the last uninterrupted cycle are stored in FLC.

To connect FLC to the power supply:

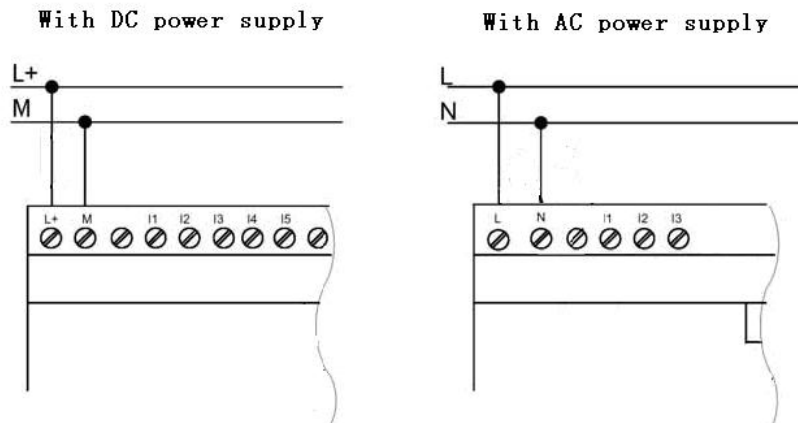

3.3.2 Connecting FLC inputs

1. Requirements

The inputs you connect sensor elements such as: momentary switches, switches, light barriers, daylight control switches etc.

	AC Type	DC Type
Signal status 0	<40VAC <0.03mA	<5VDC <0.1mA
Signal status 1	>79VAC Typical 0.06	>10VDC Typical 0.3mA
Analogue input	NO	AI1-AI4(0-10V DC)(PR-6,PR-12)

Note:

1. FLC12, FLC18 Series and versions. That can receive analog input. They can be set to analog input or digital input as either may be used in the program. They will be recognized as analog inputs when the input terminal is connected with an analog function block, and they will be recognized as switching inputs when the input terminal is not connected with an analog function block.
2. The analog inputs require DC 0V ~ +10V voltage signals. These are divided equally in 0.01V increments. In programming, all the block parameters related to the analog inputs are based on the minimum increment of 0.01V.
3. They can be recognized as switching input when the input voltage is more than 10.0V and cannot be recognized as an analog input.
4. For the switching input off, when the switch status changes from 0 to 1, the time of Status 1 must be greater than 50ms, and when the switch status changes from 1 to 0, the time of Status 0 also must be greater than 50ms.

Connecting FLC is shown as in the following figures:

*** DC type digital inputs**

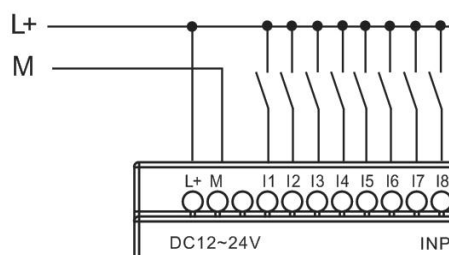

*** Analog Inputs (DC 0...10V)**

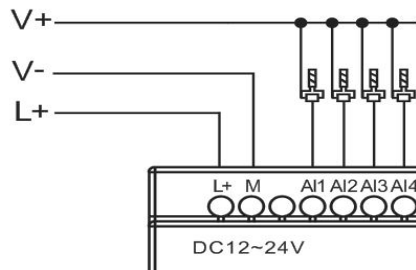

*** Analog inputs current Inputs (0...20mA)**

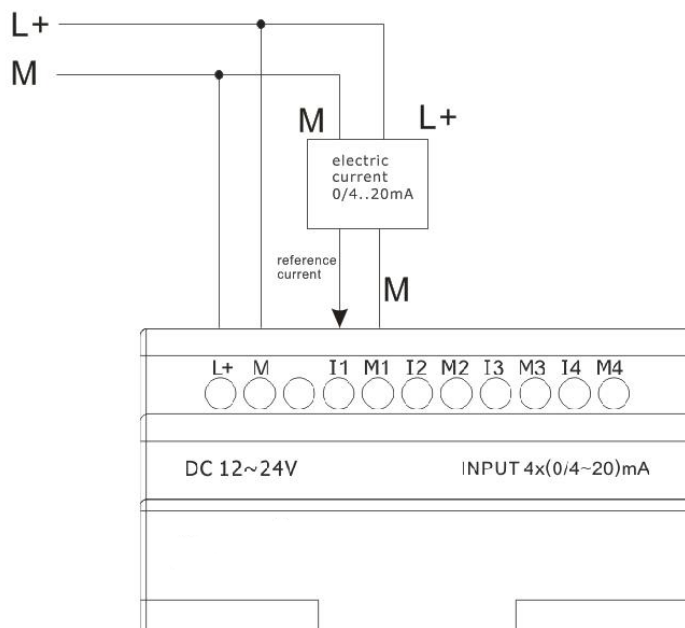

The above figure shows how to make a four-wire current measurement.

FLC18E-3PT100

It can be connected with one two-wire or three-wire resistance-type thermocouple.

When two-wire technology applied, the terminals "M1+ and IC1" (this rule also shall be applied to "M2+ and IC2", "M3+ and IC3") would be short connected. Such connection can not compensate error/ tolerance caused by the resistance in measurement loop. The measurement error of 1 Ω impedance of power cord is proportional to +2.5 °C

The three-wire technology can inhibit the influence of measurement results caused by cable length (ohmic resistance).

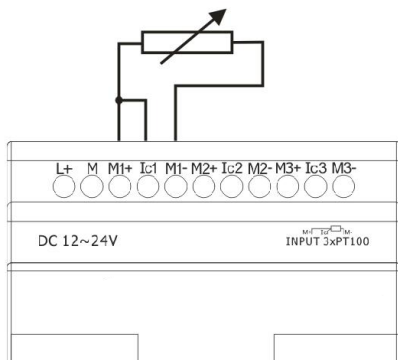

2-wire (short circuit M+ and Ic)

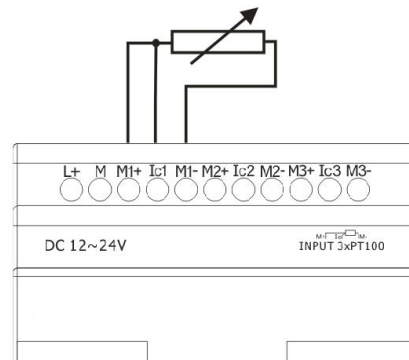

3 wire

3.3.3 Connecting FLC Outputs

1. Requirement for the relay output

Various loads such as lamp, fluorescent tube, motor, contact, etc., can be connected to the outputs of FLC. The maximum ON output current that can be supplied by FLC is 10A for the resistance load and 3A for the inductive load. The connection is in accordance with the following figure:

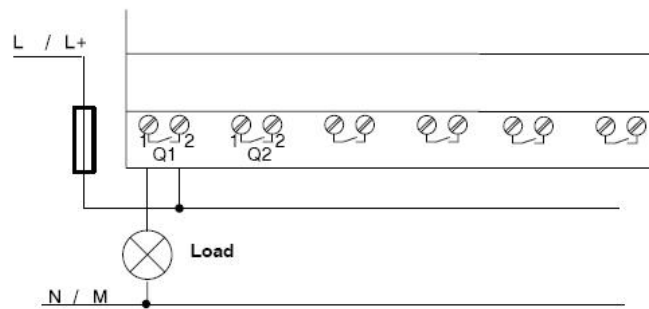

Relay Output

2. Requirement for the electronic transistor output:

The load connected to FLC must have the following characteristics:

- * The maximum switch current cannot exceed 0.3A.
- * When the switch is ON (Q=1), the maximum current is 0.3A.

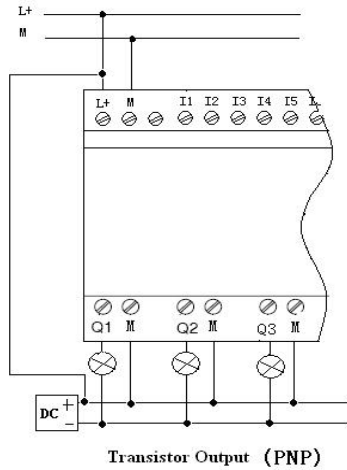

Notes (PNP):

- * The load connecting voltage must be $\leq 60V$ DC and it must be DC.
- * The "+" terminal of the output wiring must be connected with the DC positive voltage, and it must be connected with the "L+" terminal of the FLC power, a load must be connected with the "-" terminal of the DC negative voltage.

FLC18E-2AQ-VI (DC 0..10V analog output).

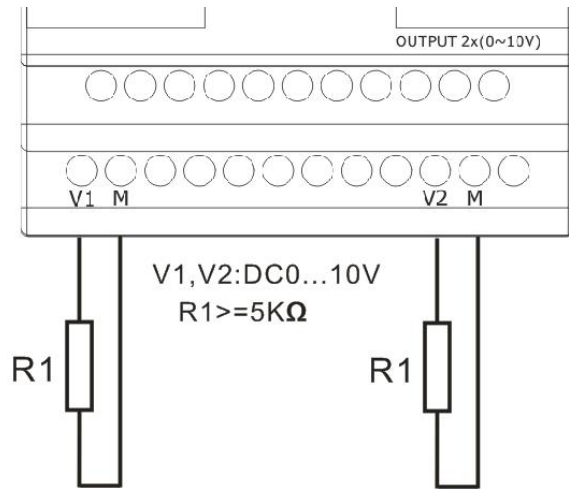

FLC18E-2AQ-VI

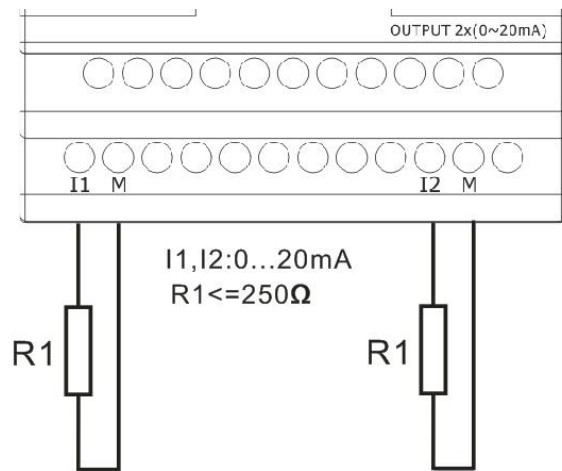

FLC18E-RS485

Actually, FLC18E-RS485 is just a converter with photo isolation bringing out 3 wiring terminals (short circuited inner of such 3 terminals, so only one channel RS485 bus is available) from RS485 port (2x8pin) of FLC18 CPU for your easy connection with other devices.

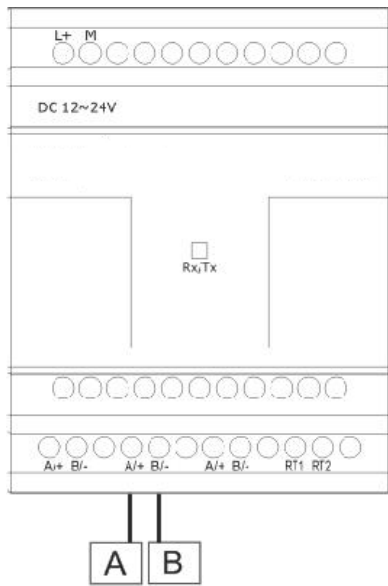

If "RT1", RT2" terminal are short connected, one 120R resistor will be connected between A/+ and B/-

3.3.4 Communication port

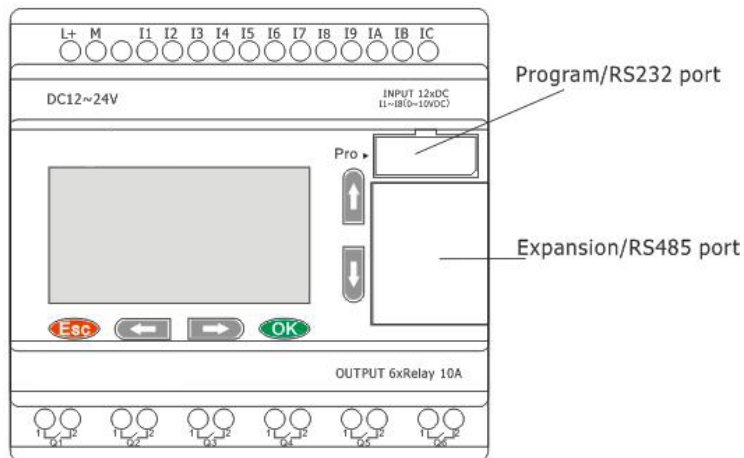

1. Programming port

(FLC-RS232, FLC-USB) should be inserted in this port).

When the programming port should be used as the standard RS232 port (D-shape 9 pin header), the FLC-RS232 cable needed. Blow is show you the pin definition of the header:

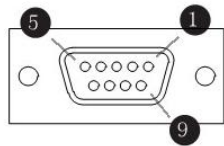

PIN	function
2	RXD
3	TXD
5	GND
others	NULL

2. Expansion port/RS485 (pin definition)

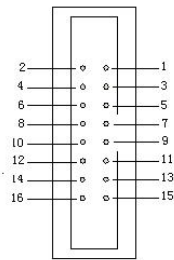

- 3-----RS485 A
- 5-----RS485 B
- 4-----GND
- 6-----GND
- 7-----CANL
- 9-----CANH
- 15-----+5V
- 16-----+5V

Communication between CPU and expansion module will use 4,7,9,15 pin.

FLC18E-RS485 module is required when FLC18 CPU communicate with the third party devices via RS485 bus.

```

>Set COM0 (COM0,Program/RS232port)
Set COM1 (COM1,for PR-RS485)
Set COM2 (COM2, PR-24 built-in RS485 port)
    
```

FLC CPUs

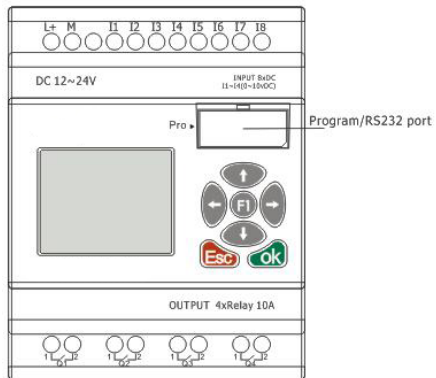

With HMI model

1. Programming port/RS232

Port (FLC-RS232, FLC-USB should be inserted in this port) named COM0.

When the programming port should be used as the standard RS232 port (D-shape 9 pin header), the FLC-RS232 cable is required.

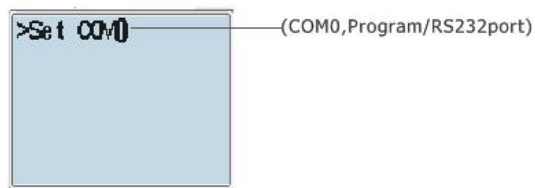

Chapter 4 Parameters modification HMI operation

4.1 Overview of FLC menu

FLC-12, FLC-18 series CPU has same menu on the LCD, so here we show the FLC-18 for example.

Parameter assignment mode

Parameter assignment menu:

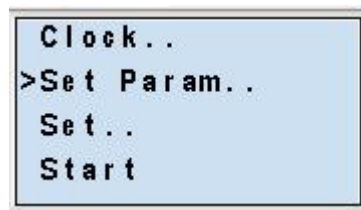

4.2 LCD panel instruction

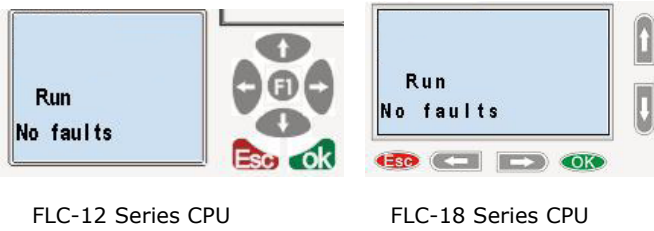

FLC-12 Series CPU

FLC-18 Series CPU

1. **Display area:** 4x16 characters can be displayed.
2. **6x Panel key:** you can modify the parameters, programming, view alarming message.

What this operate panel can do for you?

1. Display the RUN/STOP status of the CPU
 2. Display or modify the Clock
 3. Display the IO status of CPU& extensions
 4. Display all kinds registers value(AI/AO, Parameters of blocks etc.)
 5. Display multiple alarming messages
 6. Modify the parameters of blocks
 7. Backlight can be controlled via programming (Light on Alarm)
 8. System cover message can be customized
 9. Up to 64 different alarming messages is allowed.
 10. The CPU address can be modified
 11. Set password protection
 12. Change communication parameters for COM port
-

Menu shows:

Alarming message

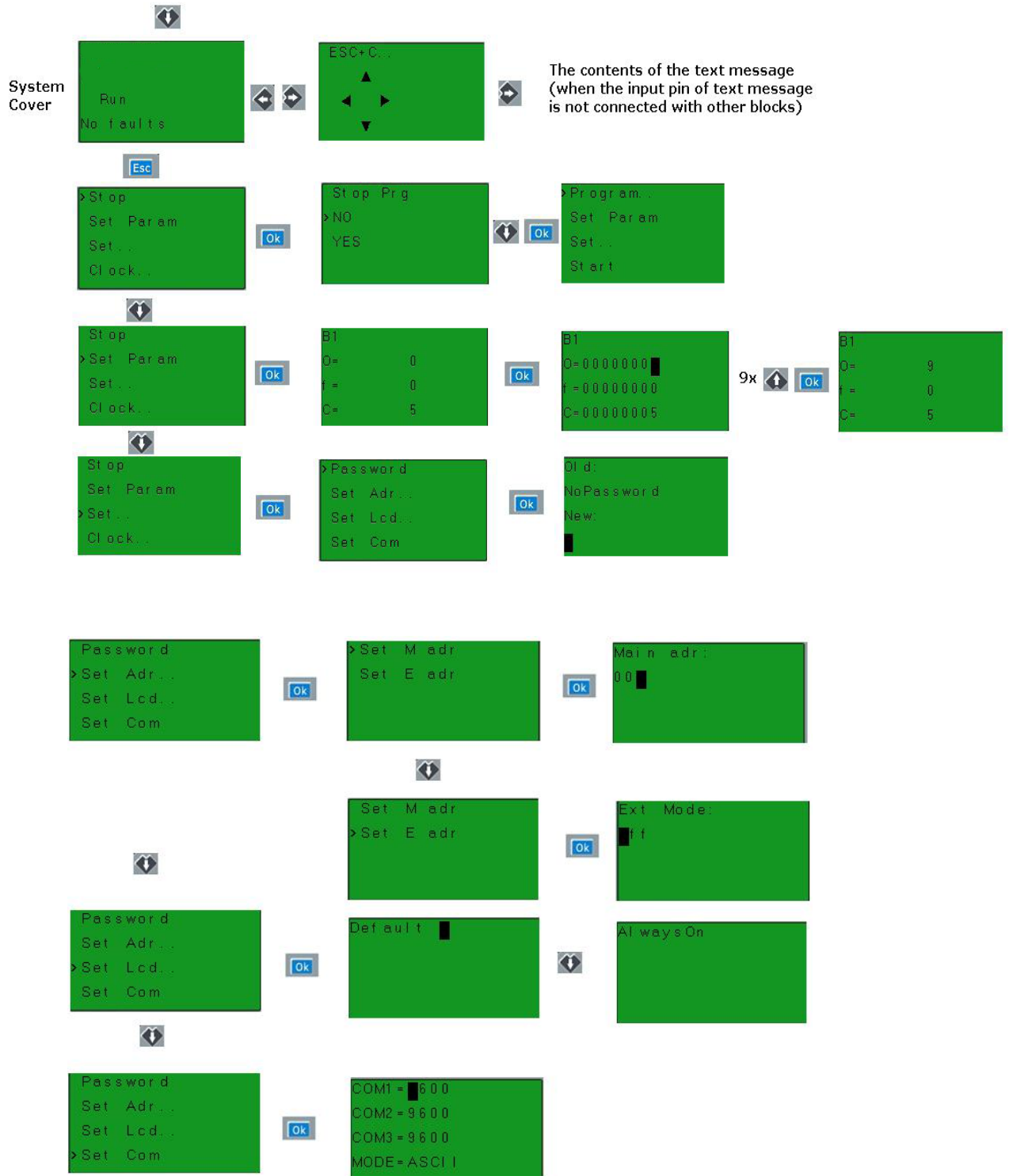



After being powered on, FLC shall self-check program stored in the CPU.

If the program is accurate, then the CPU will be running, meanwhile the system cover will show as follows:

In FLC Logic Soft, this interface is defaulted as its initialization screen.

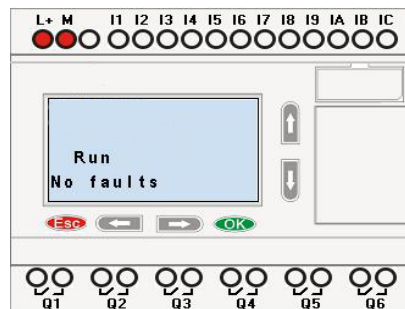

If there are several parameter pages, users can press ◀ or ▶ key to go to the page you would like.

The last page is the cursor mode:

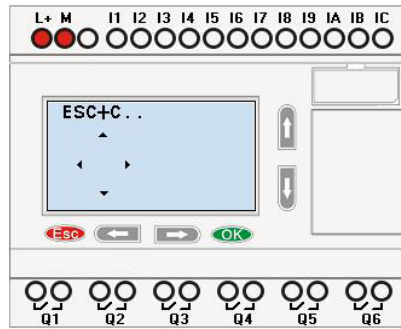

Cursor keys can be controlled in this page by press arrow keys and ESC key at the same time. If FLC has several alarm interfaces in the same period and it only displays the message with highest priority in the function block, also you may go through all alarm messages by pressing ▲ or ▼ key.

Note:

The message text block would be treated as parameter page only when it has no input, otherwise, it may be regarded as alarm page. When input has high pulse, LCD shall display alarm message.

4.3 Select function page

Press ESC key to change from running mode to function page.

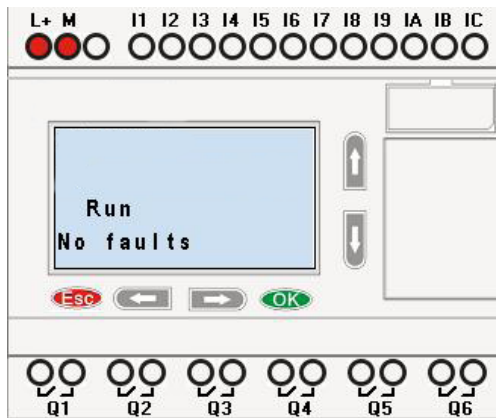

After pressing ESC key, FLC would be switched to function page and meanwhile open function menu as figure below shows.

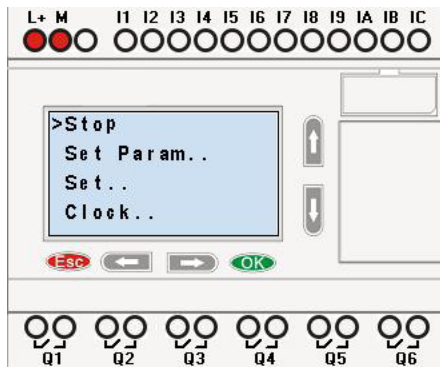

Brief introduction on 5 options of function page:

- **Run/stop**

Select this menu to switch over FLC status between RUN and Stop.
Refer to chapter 4.3.1 for details.

- **Set Param**

To set function block parameter. Refer to chapter 4.3.2 for details.

- **Set...**

Used to set/modify password, set address of CPU&extension, LCD settings and communication parameters settings refer to chapter 4.3.3 and 4.3.4 for details please.

1. "Press "UP" or "DOWN" key to move the cursor to "Set...."
2. Then press **OK** key, FLC will display as follows:

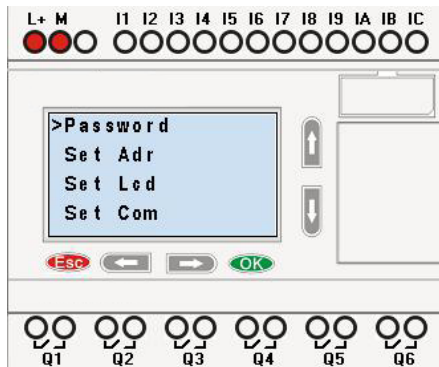

- **Clock**

To set and modify date and time. Refer to chapter 4.3.5 for details.

- **Menu Language**

To change the language of the Menu. Refer to chapter 4.3.6 for detail

4.3.1 How to switch Run/Stop

You should first select FUNCTION PAGE. (Read 4.3)

1. Move the cursor to "Run/stop": Press "UP" or "DOWN" key.
2. Move the cursor to "Yes": Press OK key.

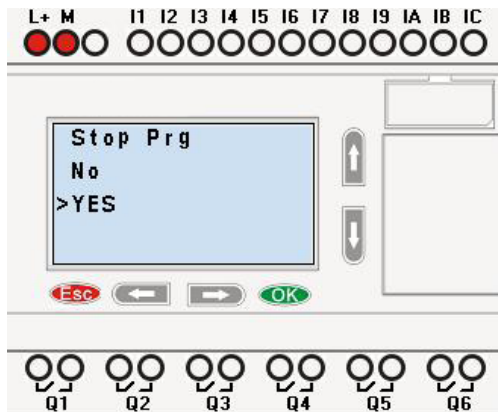

After pressing ESC key, you'll find out your circuit program has changed to "stop" status as figure below shows:

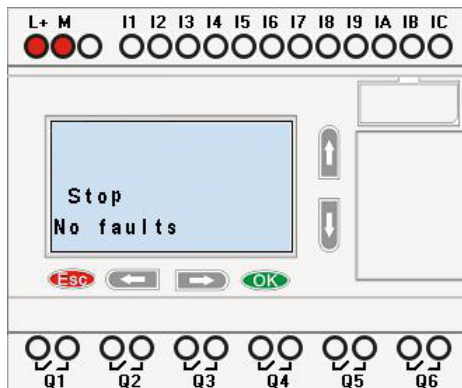

4.3.2 Set parameter

If you want to select a parameter, you need do as the following procedures:

1. Under the FUNCTION PAGE, select "Set parameter": Press ▲ or ▼ key



2. Confirm by pressing **OK** key.

Then FLC displays the first parameter, so you can modify as you like. If there is no parameter to set/modify, you can press ESC key to return.

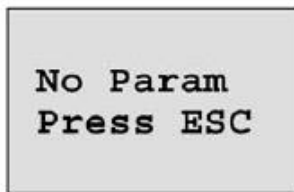
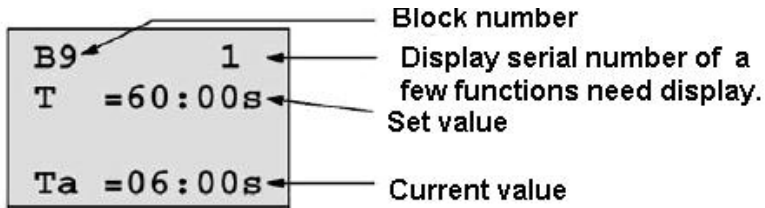

No parameter to edit ,press ESC key to return.

3. Select parameter you intend to modify.

4. Select certain specific value of that parameter which you want to edit, then press OK key.

How to modify parameter?

A. First select certain parameter which you need to edit by following the below procedures:

1. Under the FUNCTION PAGE, select "Set parameter": Press ▲ or ▼ key



2. Confirm by pressing **OK** key.

B. then you can perform the below actions to modify parameter:

1. Move the cursor to the parameter to be modified: press ◀ or ▶ key.
2. Modify value: press ▲ or ▼ key.

- Confirm the value after modification: press OK key.

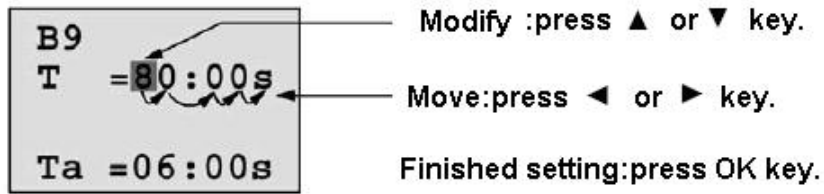

Note:

When FLC is running, not only time value but also time unit (S,M,H) can be altered, but Besides alter time parameter at RUN time, you can alter time base (s=second, m=minute, h=hour).

Current value of time T

View time T in parameter mode:

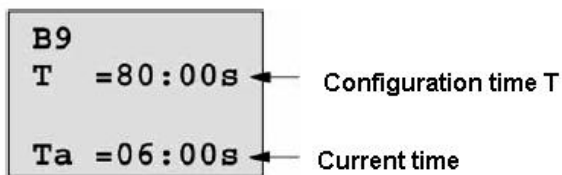

You are allowed to modify configuration time. Switch on/off time for a time segment.

In parameter mode, time segment figure of a timer:

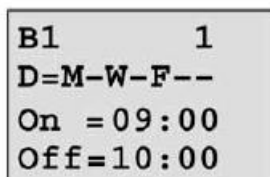

You can alter the time and date of switch on/off.

Current value of counter

In parameter mode, the parameter view of a counter:

B3	
On	=001234
Off	=000000
Cnt	=000120 ← Current count value

Current value of hour counter

In parameter mode, the view of hour counters:

B16	
MI	= 0100h ← Configured time interval
MN	= 0017h ← Time-to-go
OT	=00083h ← Total time expired since the last 1 signal at the Ral input

You can edit configured time interval (MI).

Current value of threshold trigger

In parameter mode, the view of threshold trigger:

B15	
On	=0009 ← On threshold
Off	=0005 ← Off threshold
fa	=0010 ← Course variable

You can alter the threshold value of switching on/off.

4.3.3 Set password

FLC supply password protection function for your program. You can choose according to your need. See the following instruction; you'll understand the method of setting password.

Set one password

A password contains less than or equal to 4 characters and each character is Arabian number from 0 to 9. It is easy to specify, edit or remove the password directly on the FLC in the "Password" menu of the function page:

You should first select the FUNCTION PAGE. (Read 5.2)

1. Move the cursor to "Password": Press "UP" or "DOWN" key.
2. Confirm "Password": Press OK key.

Example: let us set "1234" as password for a program. Now the LCD displays the following interface:

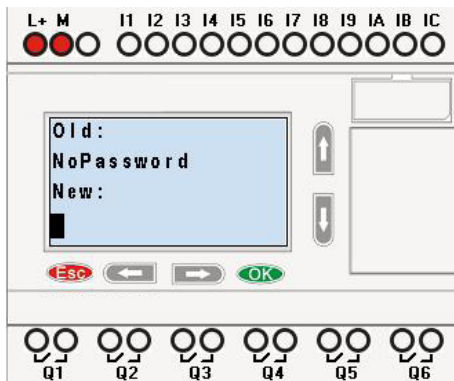

Select "New" option, and then edit it.

3. Select "1": press "UP" key once.
4. Move the cursor to the next character: press "Right" key.
5. Select "2": press "UP" key twice.
6. Move the cursor to the next character: press "Right" key.
7. Select "3": press "UP" key three times.
8. Move the cursor to the next character: press "Right" key.
9. Select "4": press "UP" key four times.

Now display:

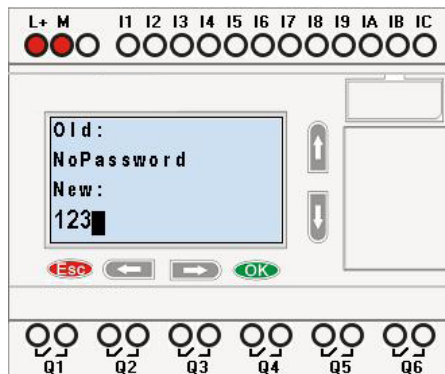

10. Confirm password: press OK key.

Now, the program is protected by the password of "1234", and then you can return to the main menu.

Note:

You can cancel a password newly-set via ESC key. In this instance, FLC will return to main menu and not reserve that password. Such password is for the parameter, that means only when you operate the menu of LCD, the password is required. The program password need be set in FLC Logic Soft by the menu File->Property-> Parameter

Modify password:

In order to modify password, you are required to present current password.

In the menu of the FUNCTION PAGE:

1. Move the cursor to "Password": Press "UP" or "DOWN" key.
2. Confirm "Password": Press OK key.

Select "Old" and input primary password (in our instance is "1234"), the process is the same as the step 3 to step 10 mentioned above.

LCD displays:

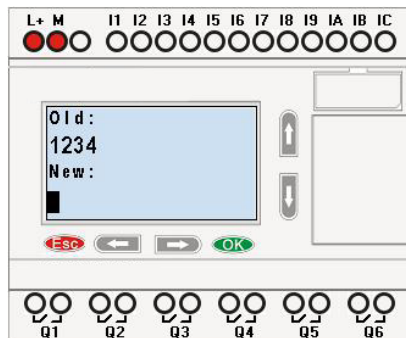

Thus, you could select "New" to input new password such as "8888":

3. Select "8": press "UP" key.
4. Move the cursor to next character: press "Right" key.

Repeat the step 3 and 4 to realize the third and fourth character.

LCD displays:

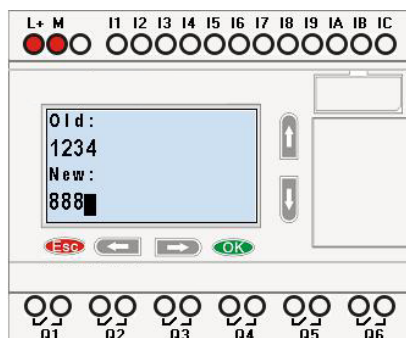

4. Confirm new password: press OK key.

So you have set the new password and then return to main menu.

How to remove the password:

In case you need to remove password e.g. allow the other users to edit your program, then you must know the current password. The process of removing password is the same as that of modifying password.

In the menu of the FUNCTION PAGE. :

1. Move the cursor to "Password": Press "UP" or "DOWN" key.
2. Confirm "Password": Press OK key.

Select "Old" and input primary password (in our instance is "8888"), the process is the same as the step 3 to step 10 mentioned above.

LCD displays as follows:

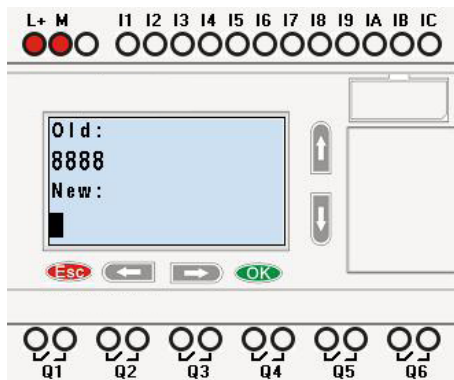

Input nothing under the "New", and let it keep blank to clear password.

4. Confirm "blank" password: press OK key. Now you have cleared password and return to main menu.

If you want to set password next time, the LCD will display:

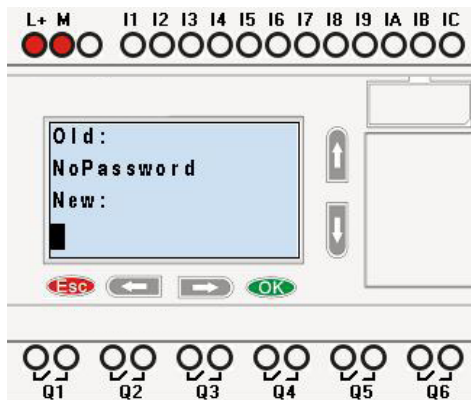

Password settings in FLC Logic Soft.

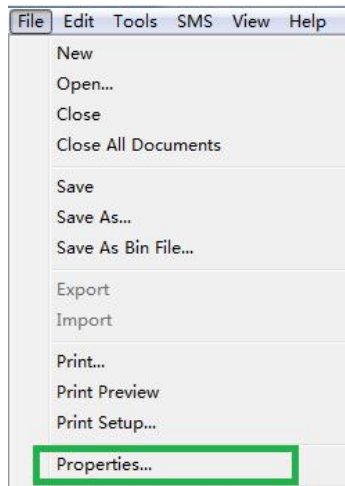

The menu **File->Properties (Parameter)**

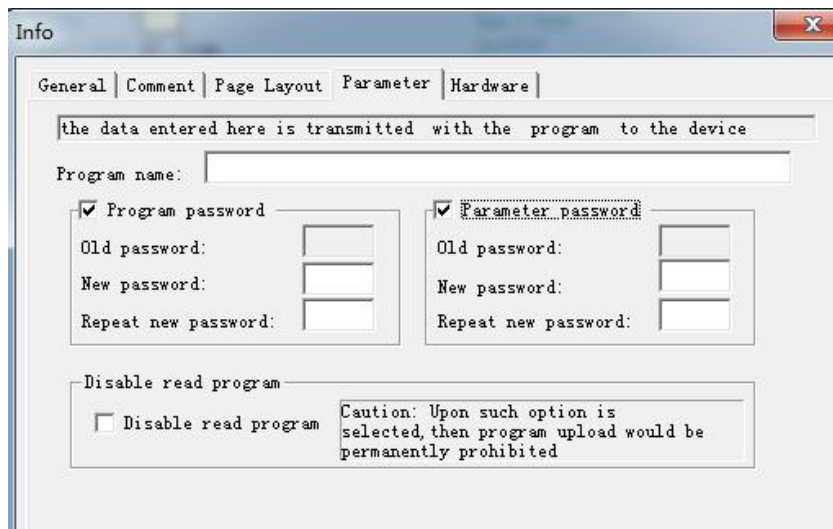

There are 2 password settings can be applied to the program, one is the program password, one is parameter password.

Program password:

If you set the program password, then the password is required when you want to upload the program into PC.

Parameter password:

If you set the parameter password, then the password is required when you want to upload the program into PC.

Note:

- 1.The password which set in the LCD menu is the parameter password.
- 2.The program password cannot be set in the LCD menu, it only can be set in FLC Logic Soft.

4.3.4 How to set address of CPU and expansion module

A. Set CPU address

If there are more than one CPU in a certain communication network,well then the address of CPU must be set differently each other. You can change the address of CPU via FLC Logic Soft, or via the panel key if the CPU with LCD panel. The address range is from 1 to 247.

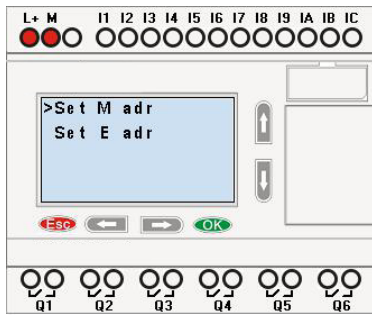

Confirm with "OK"

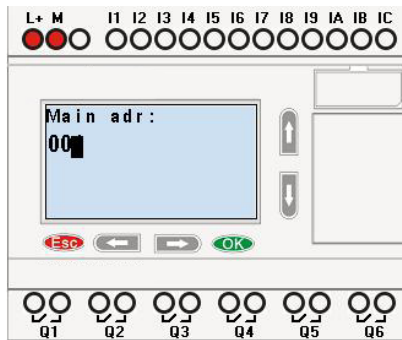

Change the address with arrow keys, and confirm with "Ok".

The CPU address also can be set by FLC Logic Soft, if the CPU without HMI, you only can set the expansion address with such method.

You can set the CPU address by the menu Tools-> Transfer-> set PLC's address in FLC Logic Soft.

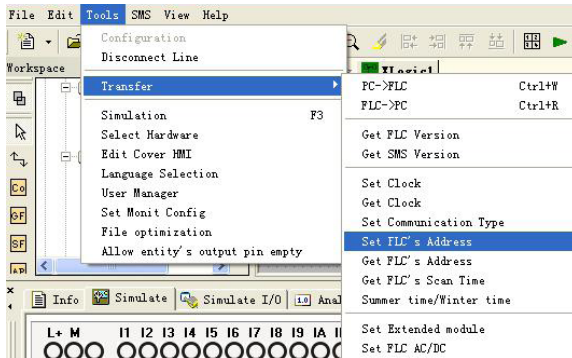

Part 2: Set address of FLC18-E extensions.

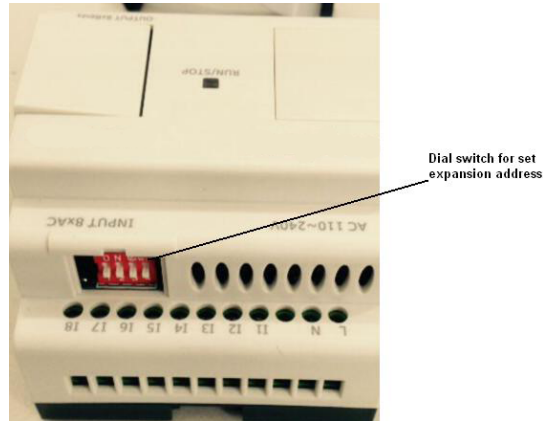

1. Plastic slice

Step 1: Using a screwdriver, take the plastic slice down and we'll find a dial switch.

Step 2: Dial the switch as the below instructions to set the address what you need.

Up to 8 extensions can be connected with the CPU.

The default address of FLC18-E extensions is 1 and the dial switch as below:

Address 1:

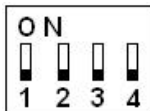

■ means the switch position

Address 2:

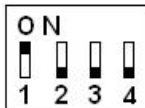

Address 3:

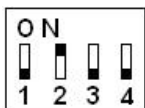

Address 4:

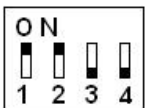

Address 5:

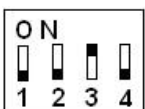

Address 6:

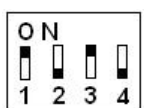

Address 7:

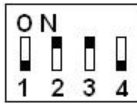

Address 8:

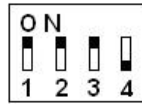

Notes:

1. The address setup of the extension module must be before powering on. Modification when powering on will be ineffective.
2. If the communication is established between CPU and extensions, the indicator on the top of the extensions' house will turn to RUN (green color) (If the LED is red, that means the CPU cannot get communication with it).
3. If more than one expansion module connect to CPU at the same time, the address of expansion module must be different each other, otherwise the system (CPU+expansions) would run abnormal, but if the expansion already has each own separately address, then the installation sequence of the expansion is not important anymore, for example you can let the expansion with address 8 as the first one with CPU.

4.3.5 Set LCD (Backlight and Contrast)

The backlight of CPU can be set "ON" time as 10 sec or "ON" all the time. The setting way as follows:

1. Select "Set..." menu and click OK.

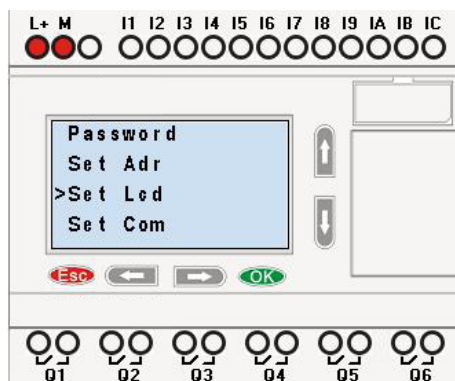

2. Select "Set LCD" menu and click "OK"

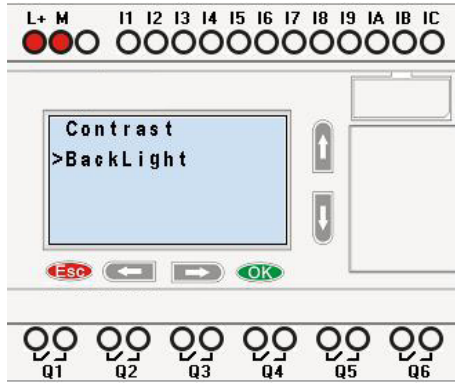

3. Select "Backlight" menu and click "OK"

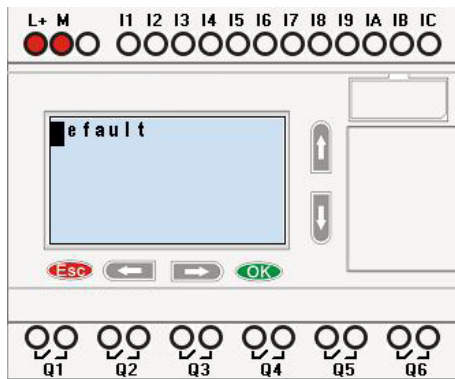

4. Default is 10 seconds, and another option is "Always On". Confirm with "OK"

Modify the contrast

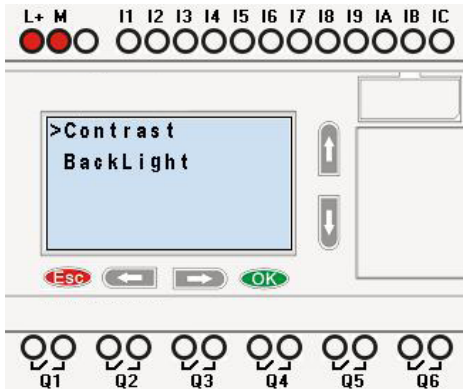

Confirm with "OK"

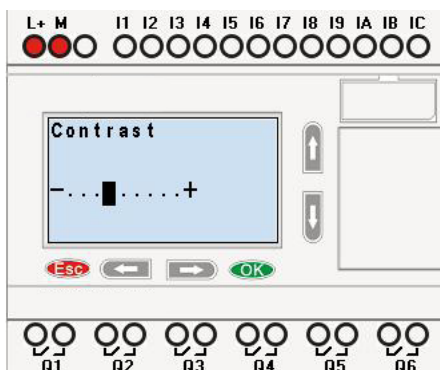

Modify the contrast with Left or right key, and confirm with "Ok".

4.3.6 Set communication parameters

Select "Set Com" menu from the menu "Set..".

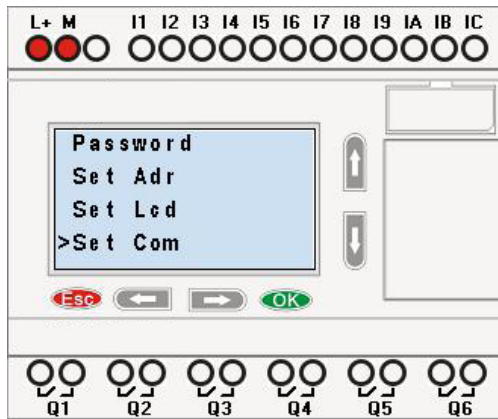

Confirm with "Ok"

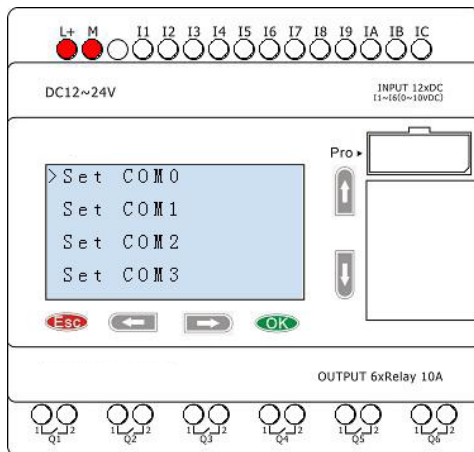

COM0: RS232 port or programming port.

COM1: RS485 port (For the FLC18E-RS485 module which shall be connected to FLC18)

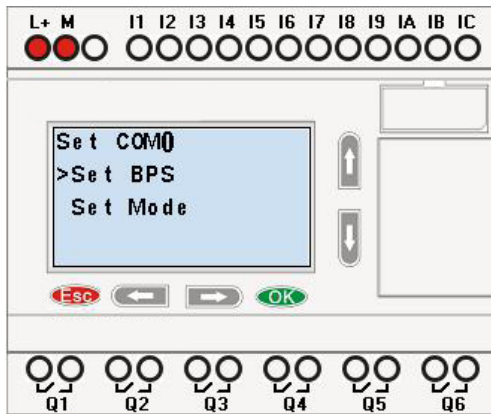

Confirm with "OK"

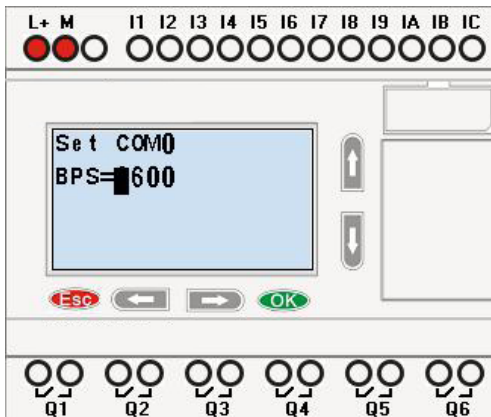

Change it with pressing Up and Down key

And confirm with "OK"

Set Modbus protocol

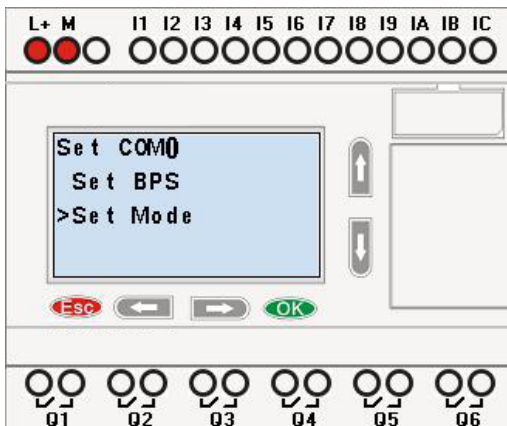

Confirm with "OK"

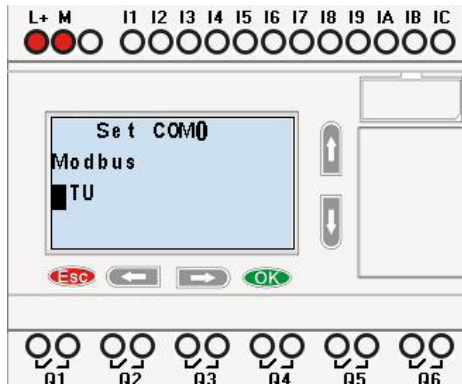

Change with Up and Down key. And confirm with "OK"

There are 4 options available: RTU, ASCII, TCP RTU, TCP ASCII.

Note: If you want to use the Modbus TCP protocol, generally, you can select the "TCP RTU".

4.3.7 Modification of System Time

You should first select the FUNCTION PAGE. (read 4.2)

1. Move the cursor to "Clock": Press "UP" or "DOWN" key.
2. Confirm "Clock": Press OK key.

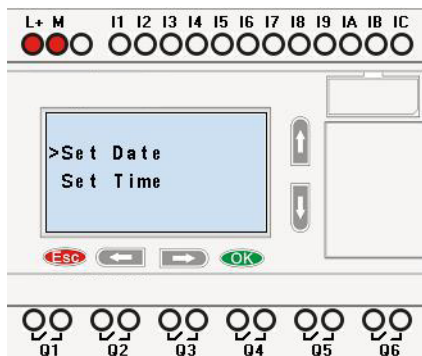

Press OK key to set and modify date.

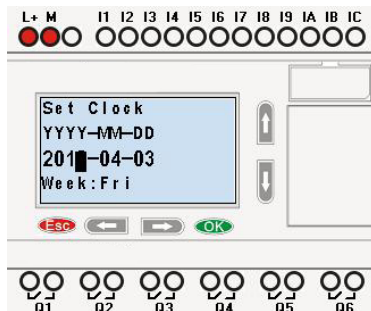

Press "UP" or "DOWN" key to realize the date which you want to set. After you finished your setting, press OK key to return to:

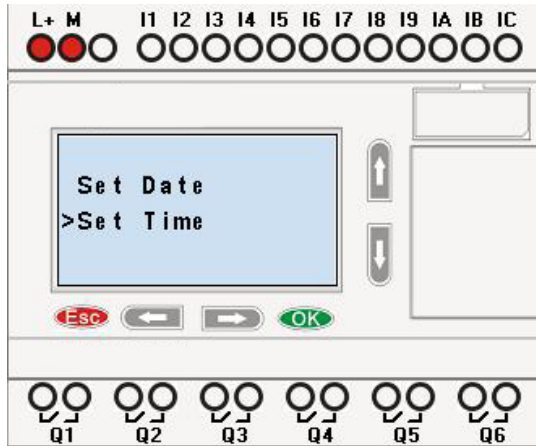

If you want to set the time further, please move the cursor to "Set Time" menu, then press OK key:

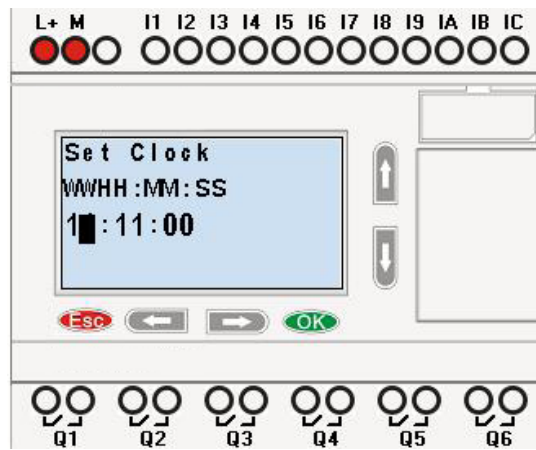

Here you can set week day (From Monday to Sunday) and the clock. The method is similar to above. After completion of your setup, press OK key:

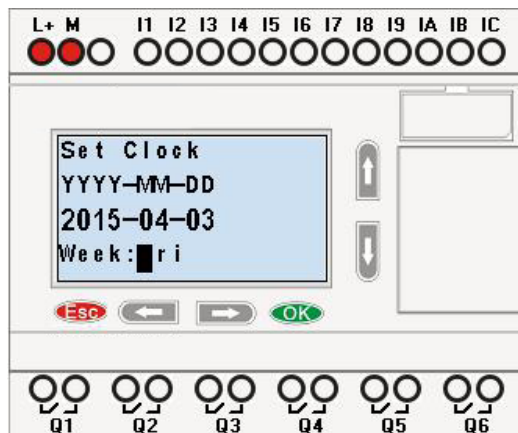

Press ESC key and return to FUNCTION PAGE.

Chapter 5 Configuring & Programming software

Users who are familiar with the logic boxes of Boolean algebra can use the FLC Configurator. In fact FLC Configurator adapts the function block programming way. FLC Configurator is available as a programming package for the PC. This mode provides many features, for example:

- A graphic interface for offline creation of your circuit program by means of Function Block Diagram (function chart)
- Simulation of your circuit program on the PC
- Generating and printing of an overview chart for the circuit program
- Saving a backup of the circuit program on the hard drive or other media
- F&F configuration of blocks
- Transferring the circuit program
- from the FLogic FLC to the PC and
- from the PC to FLogic FLC

Online test: Display of status changes and process variables of FLC in RUN mode:

- Status of a digital I/O, shift register bits and cursor keys
- The values of all analog I/Os
- The results of all blocks
- The current values (including the times) of selected blocks
- Change the output (the input pin of the output cannot be connected) status via FLC Logic Soft
- Starting and stopping circuit program execution via the PC (RUN, STOP).

The FLC Logic Soft alternative

As you can see, FLC Logic Soft represents an alternative to conventional engineering methods:

1. You start by developing the circuit program on your desktop.
2. You simulate the circuit program on your computer and verify its functions, before you actually implement it in your system.
3. You can add comments to the circuit program and create hard-copies.
4. You save a copy of your circuit program to the file system on your PC, to make it directly available for any modifications.

5. It takes only a few key actions to download the circuit program to FLC.
6. Under Simulate mode in FLC Logic Soft, you can study how to program via the panel key.

5.1 FLogic FLC Functions

FLC12 and FLC18 series adapts programming methods by means of function blocks. A total of 9 general function blocks, 60 special function blocks, and 11 input & output function blocks are configured. And each block can achieve a specific control function independently, e.g. TOND, TOFD, SBPL, TBPL, SCHD, etc. As several blocks are linked up in a specific way, relatively complicated control functions can be performed. Programming with function blocks is simpler and better appreciated than the conventional PLC instruction programming.

The following types of operator for FLC function blocks are available for options:

5.2 General Input & Output functions

5.2.1 Inputs



Input blocks represent the input terminals of FLC. Up to 8 digital inputs (FLC-12), 76 inputs (FLC-18).

In your block configuration, you can assign an input block a new input terminal, if this terminal is not already used in the circuit program.

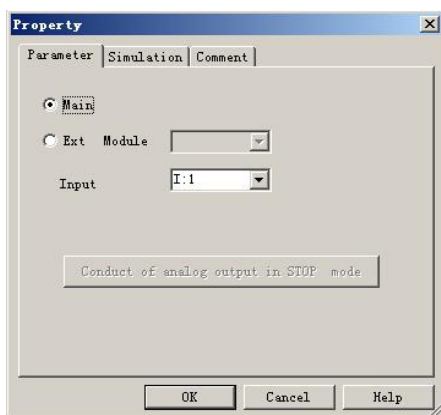

Note:

I11 means the I1 input of the expansion with address 1.

I85 means the I5 input of the expansion with address 8.

5.2.2 Cursor keys

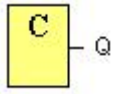

Up to four cursor keys are available to you. Cursor keys are programmed for the circuit program in the same ways as other inputs. Cursor keys can save switches and inputs, and allow operator control of the circuit program.

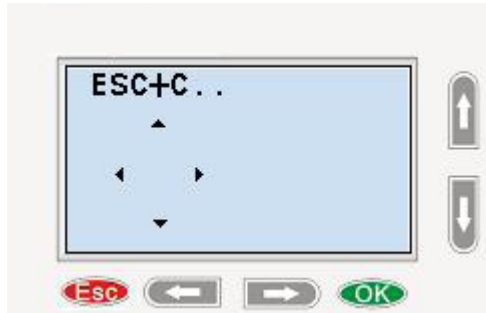

Switch the screen to current page(above shows) by pressing the Left or Right key, and press ESC key and arrow keys at the same time, then the corresponding cursor keys will turn on and give off a high trigger!

5.2.3 Outputs

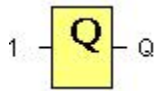

Output blocks represent the output terminals of FLC. You can use up to 4 outputs (FLC12), 70 outputs (FLC18). In your block configuration, you can assign an output block a new terminal, provided this terminal is not already used in your circuit program. The output always carries the signal of the previous program cycle. This value does not change within the current program cycle.

Note:

Q11 means the Q1 output of the expansion with address 1.

Q85 means the Q5 output of the expansion with address 8.

5.2.4 Permanent logical levels HI and LO

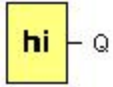

Set the block input to logical **hi** (hi = high) to set it permanently to logical '1' or 'H' state.

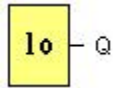

Set the block input to logical **lo** (lo = low) to set it permanently to logical '0' or 'L' state.

5.2.5 Panel Key

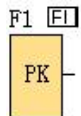

It is the symbol of the Function key on the panel (F1—F4). If one of the function keys is pressed down, the status of the corresponding symbol in the program shall turn from 0 to 1. And it shall give off one high trigger.

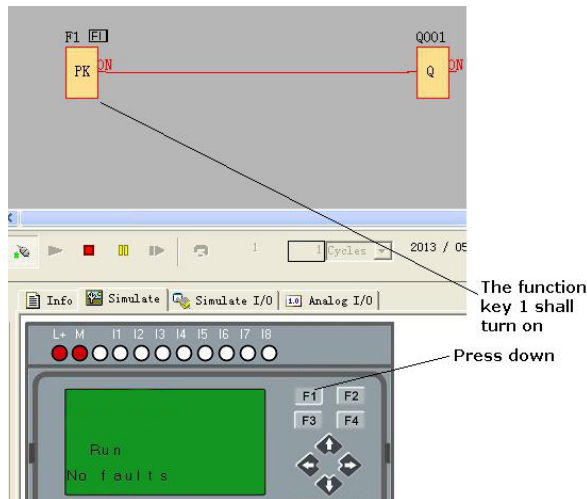

Notes:

1. Only one function key is allowed to be pressed down at any one time, if you press down two or more at the same time, FLC does not process.
2. If the arrow keys (UP, DOWN, LEFT and RIGHT), Esc and OK had been applied to the program, then they would be invalid for menu operation (e.g. manual programming, parameters modification and view alarming message etc).

5.2.6 Shift register bits

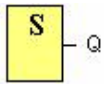

FLC provides the shift register bits S1 to S8, which are assigned the read-only attribute in the circuit program. The content of shift register bits can only be modified by means of the Shift register special function.

5.2.7 Analog inputs

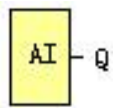

You can use up to 36 analog inputs. In your block configuration, you can assign a new input terminal to an input block, provided this terminal is not already used in the circuit program.

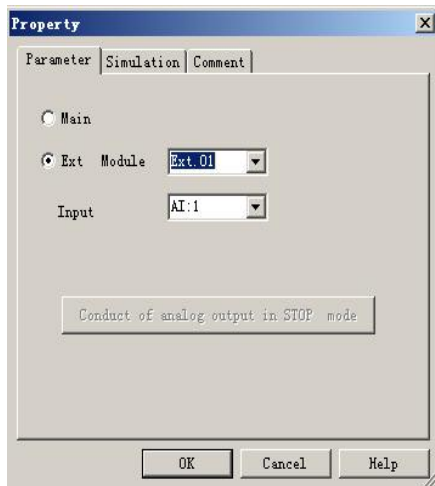

For help on analog block parameter, refer to Information on analog value processing.

Note:

AI11 means the AI1 input of the expansion with address 1.

AI82 means the AI2 input of the expansion with address 8.

Based on different analog input signals, you need select different sensor type in the analog blocks, you need use an analog amplifier with the AI input, and select the corresponding sensor type for DC0..10V, 0/4..20mA or PT100 input.

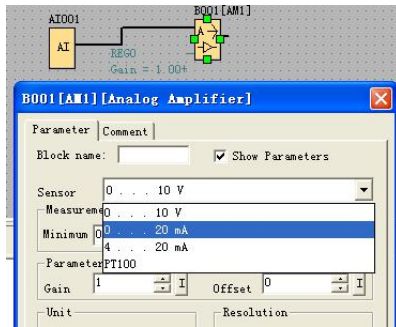

5.2.8 F (Digital flag)

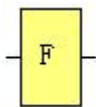

Flags are used when FLC works in a communication system. F is digital flag which is used to save / transfer signal 1 or 0 (data format is Bit) and AF is analog flag which is used to save / transfer analog values (data format is Signed short) between the master and slave devices. Up to 32 can be used when programming. In your block configuration, you can assign a new number to the flag, provided this flag number does not already exist in your circuit program. The output always carries the signal of the previous program cycle. This value does not change if the communication has failed. Startup flag: F8

The F8 flag is set in the first cycle of the user program and can thus be used in your circuit program as a **startup flag**. It is reset after the first program execution cycle.

In the subsequent cycles, the F8 flag reacts in the same way as the F1 to F64 flags.

You can use the outputs of timers, message texts, or other function blocks to activate the backlight flags. To enable multiple conditions to control the backlight of the devices, you can use multiple function blocks in parallel or in sequence.

Notes:

1. The address of "F" can be found in the modbus communication protocol file. The F block figure must have the input pin in the FLC showing.
1. Keep the input pin of F NULL (do not connect with other blocks), if you want to use the write property.

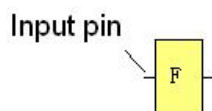

5.2.9 AF (Analog flag)



Flags are used when FLC works in a communication system. AF is analog flag which is used to save/transfer analog values (data format is Signed short) between the master and slave devices. Up to for FLC CPU can be used when programming. In your block configuration, you can assign a new number to the analog flag, provided this flag number does not already exist in your circuit program. The output always carries the signal of the previous program cycle. This value does not change if the communication were failed.

- Notes:
1. The address of "AF" can be found in the modbus communication protocol file.
 2. Keep the input pin of AF NULL (do not connect with other blocks), if you want to use the write property.

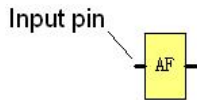

You can set a start value for the AF1--AF64 and the value does not lost if the power was failure, so you can use such AF in your program as a number input from the touch screen or the panel key of the CPU.

Notes:

1. AF65--AF256 does not support such function (start value settings). and the value of AF65--AF256 will be lost if the power is failure.
2. If you enable the "start value option" of AF, then you are not allowed to connect any other function to the input leg of the AF.
3. If you connect the input leg of AF block to other function blocks, the "start value" will not be available anymore.





5.3 Basic functions list – GF

Basic functions represent simple logical elements of Boolean algebra.

You can invert the inputs of individual basic functions , i.e. the circuit program inverts a logical "1" at a relevant input to a logical "0"; if "0" is set at the input, the program sets a logical "1".

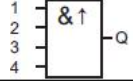
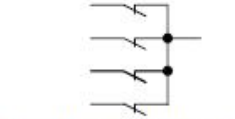
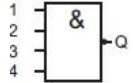
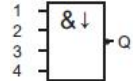
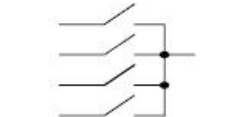
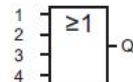
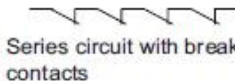
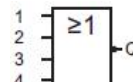
The GF list contains the basic function blocks you can use for your circuit program. The following basic functions are available:

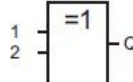
View in the circuit diagram	View in FLC Logic Soft	Name of the basic function
<p>Series circuit make contact</p>		AND

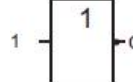
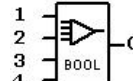
		AND with edge evaluation
 Parallel circuit with break contacts		NAND (Not AND)
		NAND with edge evaluation
 Parallel circuit with make contacts		OR
 Series circuit with break contacts		NOR (Not OR)
 Double changeover contact		XOR (exclusive OR)
 Break contact		NOT (negation, inverter)
BOOLEAN FUNCTION		BOOLEAN FUNCTION

5.3.1 AND

Circuit diagram of a series circuit with several make contacts:

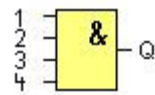

(Symbol in FLC Logic Soft)

The output of an AND function is only 1 if **all** inputs are 1, i.e. when they are closed. A block input that is not used (x) is assigned: x = 1.

Logic table of the AND block:

Input1	Input2	Input 3	Input 4	Output
0	0	0	0	0
0	0	0	1	0
0	0	1	0	0
0	0	1	1	0
0	1	0	0	0
0	1	0	1	0
0	1	1	0	0
0	1	1	1	0
1	0	0	0	0
1	0	0	1	0
1	0	1	0	0
1	0	1	1	0
1	1	0	0	0
1	1	0	1	0
1	1	1	0	0
1	1	1	1	1

5.3.2 AND with edge evaluation

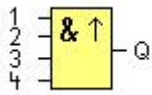

(Symbol in FLC Logic Soft)

The output of an AND with edge evaluation is only 1 if **all** inputs are 1 and **at least one** input was 0 during the last cycle.

The output is set to 1 for the duration of one cycle and must be reset to 0 for the duration of the next cycle before it can be set to 1 again.

A block input that is not used (x) is assigned: x = 1.

Timing diagram of an AND with edge evaluation

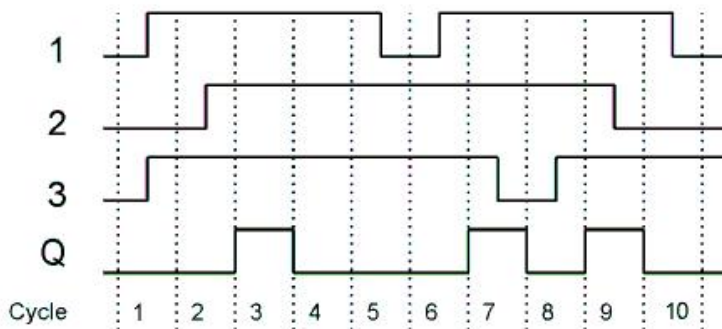

5.3.3 NAND

Parallel circuit with multiple break contacts in the circuit diagram:

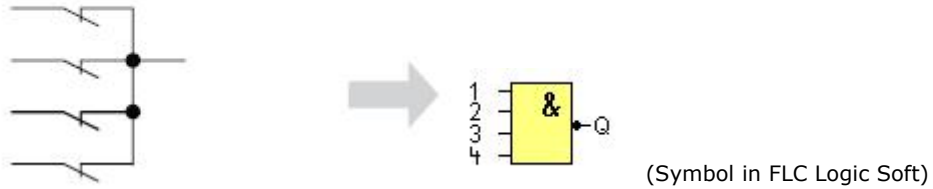

The output of an NAND function is only 0 if **all** inputs are 1, i.e. when they are closed.

A block input that is not used (x) is assigned: $x = 1$.

Logic table of the NAND block:

Input 1	Input 2	Input 3	Input 4	Output
0	0	0	0	1
0	0	0	1	1
0	0	1	0	1
0	0	1	1	1
0	1	0	0	1
0	1	0	1	1
0	1	1	0	1
0	1	1	1	1
1	0	0	0	1
1	0	0	1	1
1	0	1	0	1
1	0	1	1	1
1	1	0	0	1
1	1	0	1	1
1	1	1	0	1
1	1	1	1	0

5.3.4 NAND with edge evaluation

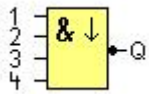

The output of a NAND with edge evaluation is only 1 **at least one** input is 0 and **all** inputs were 1 during the last cycle.

The output is set to 1 for the duration of one cycle and must be reset to 0 at least for the duration of the next cycle before it can be set to 1 again.

A block input that is not used (x) is assigned: $x = 1$.

Timing diagram of a NAND with edge evaluation

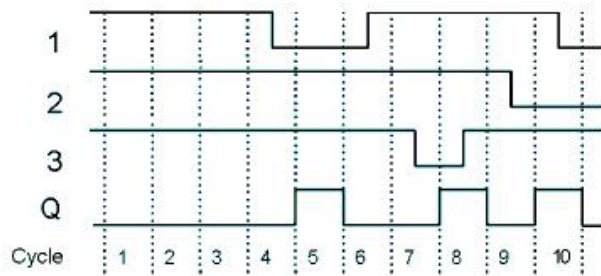

5.3.5 OR

Circuit diagram of a parallel circuit with several make contacts:

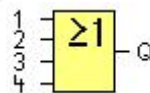
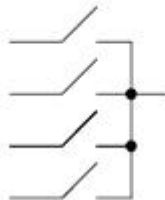

(Symbol in FLC Logic Soft)

The output of an OR is 1 if **at least one** input is 1 (closed).

A block input that is not used (x) is assigned: $x = 0$.

Logic table of the OR function:

Input 1	Input 2	Input 3	Input 4	Output
0	0	0	0	0
0	0	0	1	1
0	0	1	0	1
0	0	1	1	1
0	1	0	0	1
0	1	0	1	1
0	1	1	0	1
0	1	1	1	1
1	0	0	0	1
1	0	0	1	1
1	0	1	0	1
1	0	1	1	1
1	1	0	0	1
1	1	0	1	1
1	1	1	0	1
1	1	1	1	1

5.3.6 NOR

Circuit diagram of a series circuit with several break contacts:



The output of a NOR (NOT OR) is only 1 if **all** inputs are 0 , i.e. when they are open. When one of the inputs is switched on (logical 1 state), the output is switched off.

A block input that is not used (x) is assigned: x = 0.

Logic table of the NOR function:

Input 1	Input 2	Input 3	Input 4	Output
0	0	0	0	1
0	0	0	1	0
0	0	1	0	0
0	0	1	1	0
0	1	0	0	0
0	1	0	1	0
0	1	1	0	0
0	1	1	1	0
1	0	0	0	0
1	0	0	1	0
1	0	1	0	0
1	0	1	1	0
1	1	0	0	0
1	1	0	1	0
1	1	1	0	0
1	1	1	1	0

5.3.7 XOR

The XOR in a circuit diagram, shown as series circuit with 2 changeover contacts:

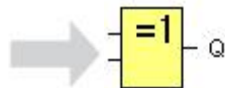

(Symbol in FLC Logic Soft)

The XOR (exclusive OR) output is 1 if the signal status of the inputs is **different**.

A block input that is not used (x) is assigned: x = 0.

Logic table of the XOR function:

Input 1	Input 2	Output
0	0	0
0	1	1
1	0	1
1	1	0

5.3.8 NOT

A break contact in the circuit diagram:

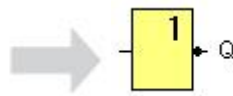

(Symbol in FLC Logic Soft)

The output is 1 if the input is 0. The NOT block inverts the input status.

Advantage of the NOT, for example: FLC no longer requires break contacts. You simply use a make contact and convert it into a break contact with the help of the NOT function.

Logic table of the NOT function:

Input 1	Output
0	1
1	0

5.3.9 Boolean Function



The **BOOLEAN** function gives the value of the output according to the combination of inputs.

The function has four inputs, and therefore 16 combinations. These combinations can be found in a truth table; for each of these, the output value can be adjusted. The number of configurable combinations depends on the number of inputs connected to the function.

Non-connected inputs are set to 0.

The following diagram shows an example of part of the Boolean function truth table:

Index	In1	In2	In3	In4	Out
1	0	0	0	0	1
2	1	0	0	0	1
3	0	1	0	0	1
4	1	1	0	0	0
5	0	0	1	0	1
6	1	0	1	0	1
7	0	1	1	0	1
8	1	1	1	0	1
9	0	0	0	1	1
10	1	0	0	1	0
11	0	1	0	1	0
12	1	1	0	1	0
13	0	0	1	1	0
14	1	0	1	1	1
15	0	1	1	1	0
16	1	1	1	1	0

Combinations of Inputs
Output status

Parameters

Having connected at least one input, you can configure the value of the output in the truth table, in the Parameters window.

The output values can be 0 for the Inactive state, and 1 for the Active state (Double click to change the 0 or 1).

By selecting the Output ON if result is TRUE option, the output takes the value configured in the truth table.

By selecting the Output OFF if result is TRUE option, the output takes the inverse value of the value configured in the truth table.

5.4 Basics on special functions

Because of their different input designation, you can see right away that there is a difference between the special functions and basic functions. SFs contain timer functions, retentive functions and various parameter assignment options, which allow you to adapt the circuit program to suit your own requirements.

This section provides you with a brief overview of input designations and with some particular background information on SFs. The SFs in particular are described in Chapter 5.5.

5.4.1 Designation of the inputs

Logical inputs

Here, you will find the description of the connectors you can use to create a logical link to other blocks or to the inputs of the FLC unit.

S (Set):

A signal at input S sets the output to logical "1".

R (Reset):

The reset input R takes priority over all other inputs and resets the outputs.

Trg (Trigger):

This input is used to trigger the start of a function.

Cnt (Count):

This input is used for counting pulses.

Fre (Frequency):

Frequency signals to be evaluated are applied to this input.

Dir (Direction):

This input determines the direction of count.

En (Enable):

This input enables a block function. When this input is "0", other signals to the block will be ignored.

Inv (Invert):

A signal at this input inverts the output signal of the block.

Ral (Reset all):

All internal values are reset.

Parameter inputs

At some of the inputs you do not apply any signals. You configure the relevant block values instead.

Examples:

Par (Parameter):

This input will not be connected. Here, you set the relevant block parameters (times, on/off thresholds etc.).

No (Cam):

This input will not be connected. Here, you configure the time patterns.

P (Priority):

This is an open input. Here, you define priorities and specify whether a message is to be acknowledged in RUN.

5.4.2 Time response

Parameter T

In some of the SFs it is possible to configure a time value T. When you preset this time, note that your input values are based on the time base set:

Time base	__ :	__
s (seconds)	seconds	: 1/100 seconds
m (minutes)	minutes	: seconds
h (hours)	hours	: minutes

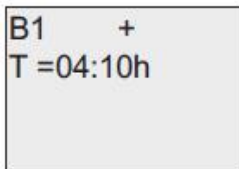

Setting a time T of 250 minutes:
 Unit in hours h:
 04:00 hours 240 minutes
 00:10 hours +10 minutes
 = 250

Accuracy of T

Because of slight tolerances in the characteristics of electronic components, the set time T may deviate. The FLC has a maximum tolerance of $\pm 0.02\%$.

When 0.02% of the time T is smaller than 0.02 seconds, the maximum deviation is 0.02 seconds.

Example: The maximum tolerance per hour (3600 seconds) is $\pm 0.02\%$, which is proportional to ± 0.72 seconds. The maximum tolerance per minute (60 seconds) is ± 0.02 seconds.

Accuracy of the timer (weekly/yearly timer)

The maximum timing in accuracy is ± 5 s/day.

5.4.3 Backup of the real-time clock

Because the internal real-time clock of an FLC is backed up, it continues operation after a power failure. The ambient temperature influences the backup time. At an ambient temperature of 25°C , the typical backup time of FLC is 100 hours.

5.4.4 Retentivity

The switching states and counter values of SFs can be set retentive. This means that current data is retained after a power failure, and that the block resumes operation at the break point. The timer is not reset, but resumes operation until the time-to-go has expired, for example, to enable this response, however,

the relevant functions must be set retentive.

R: The data is retained.

/: Current data is not retained (default). See the section in topic "Second circuit program" on enabling and disabling retentivity.

SFs hours counter, weekly timer, yearly timer and PI controller are always retentive.

5.4.5 Parameter protection

In the parameter protection settings, you can determine whether or not the parameters can be displayed and edited in FLC parameter assignment mode. Two options are available:

+: The parameter attribute permits read/write access in parameter assignment mode (default).

-: The parameter settings are read-/write-protected in parameter assignment mode, and can be edited only in programming mode. See the parameter protection mode example in the "Second circuit program".

5.4.6 Calculating the gain and offset of analog values

A sensor is connected to the analog input and converts a process variable into an electrical signal. This value of signal lies within the typical range of this sensor. FLC always converts the electrical signals at the analog input into digital values from 0 to 1000. A voltage of 0 to 10 V (or current signal 0/4... 20mA) at input AI is transformed internally into range of values from 0 to 1000. An input voltage exceeding 10 V is shown as internal value 1000.

Because you cannot always process the range of values from 0 to 1000 as predetermined by FLC, you can multiply the digital values by a gain factor and then shift the zero of the range of values (offset). This allows you to output an analog value to the FLC display, which is proportional to the actual process variable.

Parameter	Minimum	Maximum
Input voltage (in V)	0	≥ 10
Input current(in mA)	0/4	≥20
Internal value	0	1000
Gain	-10.00	+10.00
Offset	-10000	+10000

Mathematical rule

Actual value Ax =

(internal value at input Ax·gain) + offset

Gain and offset calculation

The gain and offset is calculated based on the relevant high and low values of the function.

Example 1:

The available thermocouples have the following technical data: -30 to +70°C, 0 to 10 V DC (i.e. 0 to 1000 in FLC).

Actual value = (internal value · gain) + offset, thus

$$-30 = (0 \cdot A) + B, \text{ i.e. offset } B = -30$$

$$+70 = (1000 \cdot A) - 30, \text{ i.e. gain } A = 0.1$$

Example 2:

A pressure sensor converts a pressure of 1000 mbar into a voltage of 0 V, and a pressure of 5000 mbar into a voltage of 10 V.

Actual value = (internal value · gain) + offset, thus

$$= (0 \cdot A) + B, \text{ i.e. offset } B = 1000$$

$$= (1000 \cdot A) + 1000, \text{ i.e. gain } A = 4$$







Example of analog values



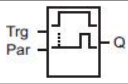
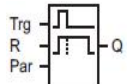
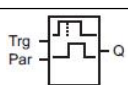

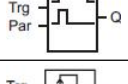
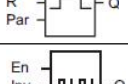
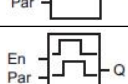

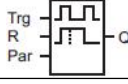

Process variable	Voltage (V)	Internal value	Gain	Offset	Value shown (Ax)
-30° C	0	0	0.1	-30	-30
0° C	3	300	0.1	-30	0
+70° C	10	1000	0.1	-30	70
1000 mbar	0	0	4	1000	1000
3700 mbar	6.75	675	4	1000	3700
5000 mbar	10	1000	4	1000	5000
	0	0	0.01	0	0
	5	500	0.01	0	5
	10	1000	0.01	0	10
	0	0	1	0	0
	5	500	1	0	500
	10	1000	1	0	1000
	0	0	10	0	0
	5	500	10	0	5000
	10	1000	10	0	10000
	0	0	0.01	5	5
	5	500	0.01	5	10
	10	1000	0.01	5	15
	0	0	1	500	500
	5	500	1	500	1000
	10	1000	1	500	1500
	0	0	1	-200	-200
	5	500	1	-200	300

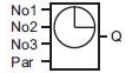
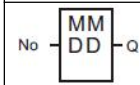
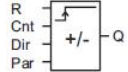
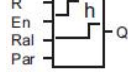

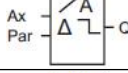
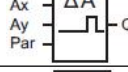
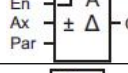
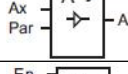
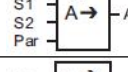

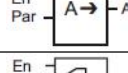
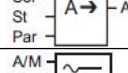
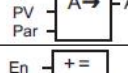

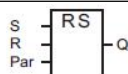
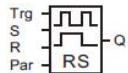
	10	1000	1	-200	800
	0	0	10	-10000	-10000
	10	1000	10	-10000	0
	0.02	2	0.01	0	0
	0.02	2	0.1	0	0
	0.02	2	1	0	2
	0.02	2	10	0	20



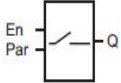
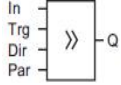
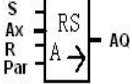
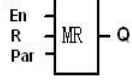
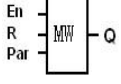

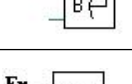
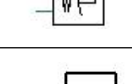

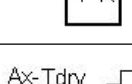
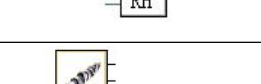
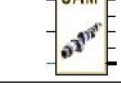





5.5 Special functions list – SF

When you create your circuit program in FLC Logic Soft, you find the special function blocks in the SF list. You can invert the inputs of SFs individually, i.e. the circuit program converts a logical "1" at the input into a logical "0"; a logical "0" it converts into a logical "1". The table also specifies whether the relevant function can be set retentive (Rem). The following SFs are available:

View in FLC	Name of the special function	Rem
Timer		
	On-delay	REM
	Off-delay	REM
	On-/Off-delay	REM
	Retentive on-delay	REM
	Wiping relay(pulse out)	REM
	Edge triggered wiping relay	REM
	Asynchronous pulse generator	REM
	Random generator	
	Stairway lighting switch	REM
	Multiple function switch	REM

	Weekly timer	
	Yearly timer	
Counter		
	Up/down counter	REM
	Hours counter	REM
	Threshold trigger	
Analog		
	Analog threshold trigger	
	Analog differential trigger	
	Analog comparator	
	Analog value monitoring	
	Analog amplifier	
	Analog multiplexer	
	Pulse Width Modulator(PWM)	
	Analog math	
	Analog ramp	
	PI controller	
	Analog math error detection	
Miscellaneous		
	Latching relay	
	Pulse relay	
	Message texts	

	Softkey	
	Shift register	
	Data latching relay	REM
	Modbus Read	
	Modbus Write	
	Memory Write	
	Memory Read	
	Word to bit	REM
	Bit to word	REM
	Device Reset	
	Comport status	
	RH math	
	Cam control block	REM
	Angular Cam Timer	

	Pumps management	
	Defrost	
	Comparison of 2 values	
	Multicompare	
	Compare in Zone	
	Conversion word bits	
	Conversion bits word	
	Demultiplexer	
	Multiplexing	
	Multiplexer	
	Square root	
	Sin Cos	

5.5.1 On-delay

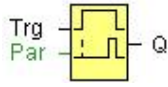

Short description

The output is not switched on until a configured delay time has expired.

Connection	Description
Trg input	The on delay time is triggered via the Trg (Trigger) input
Parameter	T represents the on delay time after which the output is switched on (output signal transition 0 to 1). Retentivity on = the status is retentive in memory.
Output Q	Q switches on after a specified time T has expired, provided Trg is still set.

Parameter T

The time for parameter T can also be preset based on the actual value of another, already-configured function. You can use the actual values of the following functions:

Analog comparator:	Ax - Ay
Analog trigger:	Ax
Analog amplifier:	Ax
Analog multiplexer:	AQ
Analog ramp:	AQ
Analog math:	AQ
PI controller:	AQ
Data latching relay:	AQ
Up/Down counter:	Cnt

You select the required function via the block number. Time-base can be adjusted.

The value of " T " can be set/modified in parameter mode. For information about how to modify, refer to chapter

For information on the validity and accuracy of the time base, refer to the FLC time-base list as follows:

Valid ranges of the time-base, if T = parameter

Time-base	Max. value	Min. resolution	Accuracy
s (seconds)	99:99	10 ms	± 10 ms
m (minutes)	99:59	1s	± 1 s
h (hours)	99:59	1 min	± 1 min

Valid ranges of the time base, if T = Actual value of an already-programmed function

Timebase	max. value	Meaning	Accuracy
ms	99990	Number of ms	+ 10 ms
s	5999	Number of s	+ 1 s
m	5999	Number of min	+ 1 min

Timing diagram

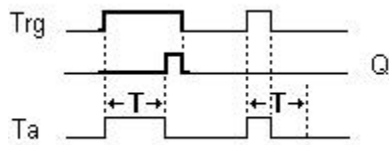

Description of the function

The time Ta (the current time in FLC) is triggered with the 0 to 1 transition at input Trg. If the status at input Trg stays 1 at least for the duration of the configured time T, the output is set to 1 when this time has expired (the on signal of the output follows the on signal of the input with delay). The time is reset if the status at input Trg changes to 0 again before the time T has expired. The output is reset to 0 when input Trg is 0.

5.5.2 Off-delay

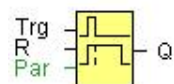

Short description

The output with off delay is not reset until a defined time has expired.

Connection	Description
Input Trg	Start the off delay time with a negative edge (1 to 0 transition) at input Trg (Trigger)
Input R	Reset the off delay time and set the output to 0 via the R (Reset) input. Reset has priority over Trg
Parameter	T : The output is switched off on expiration of the delay time T (output signal transition 1 to 0). Retentivity on = the status is retentive in memory.
Output Q	Q is switched on for the duration of the time T after a trigger at input Trg.

Parameter

The time set in parameter T can be supplied by the value of another already-programmed function:

Analog comparator:	Ax - Ay
Analog trigger:	Ax
Analog amplifier:	Ax
Analog multiplexer:	AQ
Analog ramp:	AQ
Analog math:	AQ
PI controller:	AQ
Data latching relay:	AQ
Up/Down counter:	Cnt

The value of " T " can be set/modified in parameter mode. For information about how to modify, refer to chapter

Select the required function by the block number. The time base is configurable. For information on valid time base ranges and parameter preset, refer to chapter 5.5.1 the On-delay topic.

Timing diagram

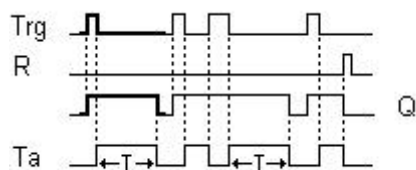

Description of the function

Output Q is set to 1 momentarily with a 0 to 1 transition at input Trg.

At the 1 to 0 transition at input Trg, FLC retriggers the current time T, and the output remains set.

The output Q is reset to 0 when T_a reaches the value specified in T ($T_a=T$) (off delay).

A one-shot at input Trg retriggers the time T_a .

You can reset the time T_a and the output via the input R (Reset) before the time T_a has expired.

If retentivity is not set, output Q and the expired time are reset after a power failure.

5.5.3 On-/Off-delay

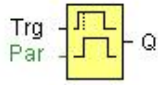

Short description

The on/off delay function is used to set an output after a configured on delay time and then reset it again upon expiration of a second configured time.

Connection	Description
Input Trg	You trigger the on delay with a positive edge (0 to 1 transition) at input Trg (Trigger). You trigger the off delay with a negative edge (1 to 0 transition).
Parameter	T_H is the on delay time for the output (output signal transition 0 to 1). T_L is the off delay time for the output (output signal transition 1 to 0). Retentivity on = the status is retentive in memory.
Output Q	Q is switched on upon expiration of a configured time T _H if Trg is still set. It is switched off again upon expiration of the time T _L and if Trg has not been set again.

Parameter

The on-delay time and off-delay time set in parameter TH and TL can be provided by the actual value of another already-programmed function:

Analog comparator:	Ax – Ay
Analog trigger:	Ax
Analog amplifier:	Ax
Analog multiplexer:	AQ
Analog ramp:	AQ
Analog math:	AQ
PI controller:	AQ
Data latching relay:	AQ
Up/Down counter:	Cnt

The value of "TH", "TL" can be set/modified in parameter mode. For information about how to modify, refer to chapter

For information on the validity and accuracy of the time base, refer to

Timing diagram

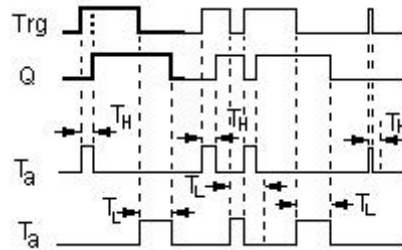

Description of the function

The time T_H is triggered with a 0 to 1 transition at input Trg.

If the status at input Trg is 1 at least for the duration of the configured time T_H , the output is set to logical 1 upon expiration of this time (output is on delayed to the input signal).

The time T_H is reset if the status at input Trg is reset to 0 before this time has expired.

The time T_L is triggered with the 1 to 0 transition at the output.

If the status at input Trg remains 0 at least for the duration of a configured time T_L , the output is reset to 0 upon expiration of this time (output is off delayed to the input signal).

The time T_L is reset if the status at input Trg is returns to 1 before this time has expired.

5.5.4 Retentive on-delay

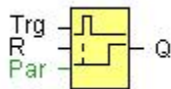

Short description

A one-shot at the input triggers a configurable time. The output is set upon expiration of this time.

Connection	Description
Input Trg	Trigger the on delay time via the Trg (Trigger) input.
Input R	Reset the time on delay time and reset the output to 0 via input R (Reset). Reset takes priority over Trg .
Parameter	T is the on delay time for the output (output signal transition 0 to 1). Retentivity on = the status is retentive in memory.
Output Q	Q is switched on upon expiration of the time T.

Parameter

The time in parameter T can be provided by the value of another already-programmed function:

Analog comparator:	Ax – Ay
Analog trigger:	Ax
Analog amplifier:	Ax
Analog multiplexer:	AQ
Analog ramp:	AQ
Analog math:	AQ
PI controller:	AQ
Data latching relay:	AQ
Up/Down counter:	Cnt

The value of "T" can be set/modified in parameter mode. For information about how to modify, refer to chapter

Timing diagram

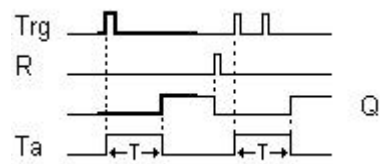

Description of the function

The current time Ta is triggered with a 0 to 1 signal transition at input Trg. Output Q is set to 1 when Ta reaches the time T. A further pulse at input Trg does not affect Ta.
 The output and the time Ta are only reset to 0 with a 1 signal at input R.
 If retentivity is not set, output Q and the expired time are reset after a power failure.

5.5.5 Wiping relay (pulse output)

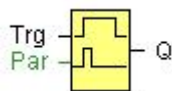

Short description

An input signal generates an output signal of a configurable length.

Connection	Description
Input Trg	You trigger the time for the wiping relay with a signal at input Trg (Trigger)
Parameter	TL represents the time after which the output is reset (output signal transition 1 to 0). Retentivity set (on) = the status is retentive in memory.
Output Q	A pulse at Trg sets Q. The output stays set until the time T has expired and if Trg = 1 for the duration of this time. A 1 to 0 transition at Trg prior to the expiration of T also resets the output to 0.

Parameter

The off time T can be provided by the actual value of another already-programmed function:

- Analog comparator: Ax – Ay
- Analog trigger: Ax
- Analog amplifier: Ax
- Analog multiplexer: AQ
- Analog ramp: AQ
- Analog math: AQ
- PI controller: AQ
- Data latching relay: AQ
- Up/Down counter: Cnt

The value of "TL" can be set/modified in parameter mode. For information about how to modify, refer to chapter

Timing diagram

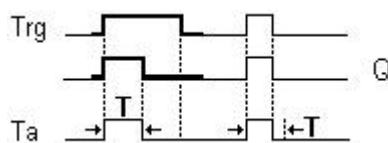

Description of the function

With the input signal Trg = 1, output Q is set to 1. The signal also triggers the time Ta, while the output remains set.

When Ta reaches the value defined at T (Ta=T), the output Q is reset to 0 state (pulse output).

If the signal at input Trg changes from 1 to 0 before this time has expired, the output is immediately reset from 1 to 0.

5.5.6 Edge triggered wiping relay

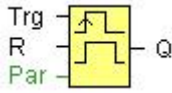

Short description

An input pulse generates a preset number of output pulses with a defined pulse/pause ratio (retriggerable), after a configured delay time has expired.

Connection	Description
Input Trg	You trigger the times for the Edge-triggered wiping relay with a signal at input Trg (Trigger).
Input R	The output and the current time T_a are reset to 0 with a signal at input R.
Parameter	<p>TL, TH: The inter-pulse period T_L and the pulse period T_H are adjustable.</p> <p>N determines the number of pulse/pause cycles T_L / T_H: Value range: 1...9.</p> <p>Retentivity set (on) = the status is retentive in memory.</p>
Output Q	Output Q is set when the time T_L has expired and is reset when T_H has expired.

Parameter

The pulse width T_H and the inter-pulse width T_L can be provided by the actual value of another already-programmed function:

Analog comparator:	$A_x - A_y$
Analog trigger:	A_x
Analog amplifier:	A_x
Analog multiplexer:	AQ
Analog ramp:	AQ
Analog math:	AQ
PI controller:	AQ
Data latching relay:	AQ
Up/Down counter:	Cnt

The value of "TH", "TL" can be set/modified in parameter mode. For information about how to modify, refer to chapter

Timing diagram

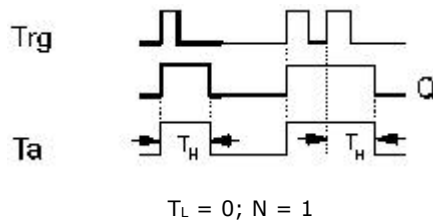

Description of the function

With the change at input Trg to 1, the time T_L (time low) is triggered. After the time T_L has expired, output Q is set to 1 for the duration of the time T_H (time high).

If input Trg is retriggered prior to the expiration of the preset time ($T_L + T_H$), the time Ta is reset and the pulse/pause period is restarted.

If retentivity is not set, output Q and the time are reset after a power failure.

5.5.7 Asynchronous pulse generator

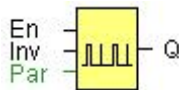

Description of function

The pulse shape at the output can be modified via a configurable pulse/pause ratio.

Connection	Description
Input En	You enable/disable the asynchronous pulse generator with the signal at input En.
Input Inv	The Inv input can be used to invert the output signal of the active asynchronous pulse generator..
Parameter	TL, TH: You can customize the pulse (TL)/ pause (TH) ratio. Retentivity set (on) = the status is retentive in memory.
Output Q	Q is toggled on and off cyclically with the pulse times T_H and T_L .

Parameter

The pulse width TH and the inter-pulse width TL can be provided by the actual value of another already-programmed function:

Analog comparator: Ax – Ay

Analog trigger: Ax

Analog amplifier: Ax
 Analog multiplexer: AQ
 Analog ramp: AQ
 Analog math: AQ
 PI controller: AQ
 Data latching relay: AQ
 Up/Down counter: Cnt

The value of "TH", "TL" can be set/modified in parameter mode. For information about how to modify, refer to chapter

Timing diagram

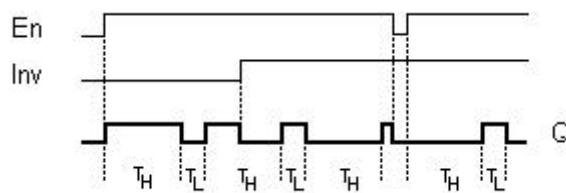

Description of the function

You can set the pulse/pause ratio at the TH (Time High) and TL (Time Low) parameters. The INV input can be used to invert the output signal. The input block INV only inverts the output signal if the block is enabled via EN. If retentivity is not set, output Q and the expired time are reset after a power failure.

5.5.8 Random generator

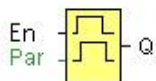

Short description

The output of a random generator is toggled within a configurable time.

Connection	Description
Input En	The positive edge (0 to 1 transition) at the enable input En (Enable) triggers the on delay for the random generator. The negative edge (1 to 0 transition) triggers the off delay for the random generator.
Parameter	TH: The on delay is determined at random and lies between 0 s and TH. TL: The off delay is determined at random and lies

	between 0 s and T_L .
Output Q	Q is set on expiration of the on delay if En is still set. It is reset when the off delay time has expired and if En has not been set again.

Parameter

The on-delay time T_H and the off-delay time T_L can be provided by the actual value of another already-programmed function:

- Analog comparator: Ax – Ay
- Analog trigger: Ax
- Analog amplifier: Ax
- Analog multiplexer: AQ
- Analog ramp: AQ
- Analog math: AQ
- PI controller: AQ
- Data latching relay: AQ
- Up/Down counter: Cnt

The value of "TH", "TL" can be set/modified in parameter mode. For information about how to modify, refer to chapter

Timing diagram

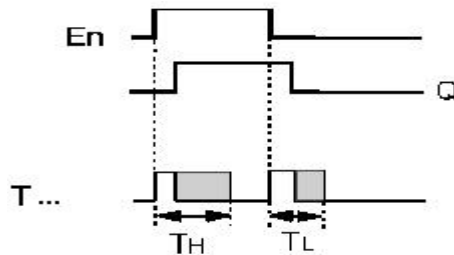

Description of the function

With the 0 to 1 transition at input En, a random time (on delay time) between 0 s and T_H is set and triggered. If the status at input En is 1 at least for the duration of the on delay, the output is set to 1 when this on delay time has expired.

The time is reset if the status at input En is reset to 0 before the on delay time has expired.

When input En is reset 0, a random time (off delay time) between 0 s and T_L is set and triggered.

If the status at input En is 0 at least for the duration of the off delay time, the output Q is reset to 0 when the off delay time has expired.

The time is reset if the status at input En returns to 1 before the on delay time has expired.

5.5.9 Stairway lighting switch

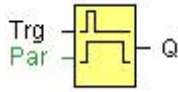

Short description

The edge of an input pulse triggers a configurable time. The output is reset when this time has expired. An off warning can be output prior to the expiration of this time.

Connection	Description
Input Trg	You trigger the time (off delay) for the stairway switch with a signal at input Trg (Trigger).
Parameter	<p>T: The output is reset (1 to 0 transition when the time T has expired.</p> <p>T_i: Determines the triggering time for the pre-warning.</p> <p>T_{IL}: determines the length of the pre-warning time.</p> <p>Retentivity set (on) = the status is retentive in memory.</p>
Output Q	Q is reset after the time T has expired. A warning signal can be output before this time has expired.

Parameter

The off-delay time T, the pre-warning time T_i and the pre-warning period T_{IL} can be provided by the actual value of another already-programmed function:

- Analog comparator: Ax – Ay
- Analog trigger: Ax
- Analog amplifier: Ax
- Analog multiplexer: AQ
- Analog ramp: AQ
- Analog math: AQ
- PI controller: AQ
- Data latching relay: AQ
- Up/Down counter: Cnt

The value of "T" can be set/modified in parameter mode. For information about how to modify, refer to chapter

Timing diagram

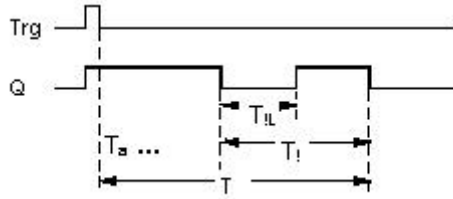

Changing the time base

You can change the pre-warning time base and the period.

Time base T	Pre-warning time	Pre-warning period
Seconds	750 ms	50 ms
Minutes	15 s	1 s
Hours	15 min	1 min
* makes sense only for programs with a cycle time of < 25 ms		

Description of the function

Output Q is set to 1 with a 0 to 1 signal transition at input Trg. The 1 to 0 transition at input Trg triggers the current time and output Q remains set.

Output Q is reset to 0 when T_a reaches the time T. Before the off delay time $(T - T_i)$ has expired, you can output a pre-warning that resets Q for the duration of the off pre-warning time T_{iL} .

T_a is retrigged (optional) at the next high/low transition at input Trg and if T_a is expiring.

If retentivity is not set, output Q and the expired time are reset after a power failure.

Setting the Par parameter

Note

All times must have the same time base.

View in parameter assignment mode (example):

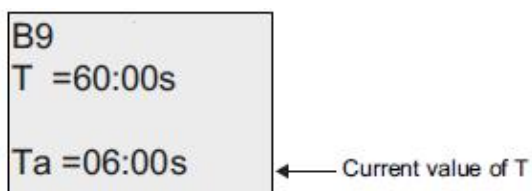

5.5.10 Multiple function switch

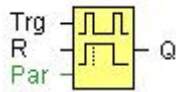

Short description

Switch with two different functions:

- Pulse switch with off delay
- Switch (continuous light)

Connection	Description
Input Trg	With a signal at input Trg (Trigger) you set output Q (continuous light), or reset Q with off delay. Output Q can be reset with a signal at the Trg input.
Input R	You set the current time T_a , and reset the output to 0, with a signal at input R.
Parameter	<p>T: The output is reset (1 to 0 transition) when the time T has expired.</p> <p>T_L determines the period during which the input must be set in order to enable the permanent light function.</p> <p>T_I Determines the on delay for the pre-warning time.</p> <p>T_{IL} determines the length of the pre-warning time.</p> <p>Retentivity set (on) = the status is retentive in memory.</p>
Output Q	Output Q is set with a signal at input Trg, and it is reset again after a configured time has expired and depending on the pulse width at input Trg, or it is reset with another signal at input Trg.

Parameter

The off-delay time T, the permanent light time T_L , the on-delay pre-warning time T_I , and the pre-warning time period T_{IL} can be provided by the actual value of another already-programmed function:

Analog comparator:	$A_x - A_y$
Analog trigger:	A_x
Analog amplifier:	A_x
Analog multiplexer:	A_Q
Analog ramp:	A_Q
Analog math:	A_Q
PI controller:	A_Q
Data latching relay:	A_Q

Up/Down counter: Cnt

The value of "T", "TH" can be set/modified in parameter mode. For information about how to modify, refer to chapter

Timing diagram

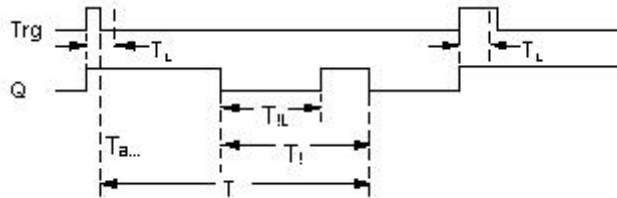

Description of the function

Output Q is set to 1 with a 0 to 1 signal transition at Trg.

If output Q = 0, and input Trg is set hi at least for the duration of TL, the permanent lighting function is enabled and output Q is set accordingly.

The off delay time T is triggered when the status at input Trg changes to 0 before the time TL has expired. Output Q is reset when the Ta = T.

Before the off delay time (T - T_I) has expired, you can output an off pre-warning that resets Q for the duration of the off pre-warning time T_{IL}. A further signal at input Trg always resets T and output Q.

Caution

The time base for the T, T_I and T_{IL} must be identical.

If retentivity is not set, output Q and the expired time are reset after a power failure.

5.5.11 Weekly timer

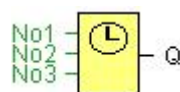

Caution

Your FLC must be equipped with an internal real-time clock if you are going to use this SFB.

Short description

The output is controlled by means of a configurable on/off date. The function supports any combination of weekdays.

Connection	Description
Parameter	At the No1, No2, No3 (cam)

	parameters you set the on and off triggers for each cam of the weekly timer. The parameter units are the days and the time-of-day.
Output Q	Q is set when the configured cam is actuated.

Parameter

You can configure a time hysteresis for each individual cam in parameter mode. For information about how to modify, refer to chapter

Timing diagram (three practical examples)

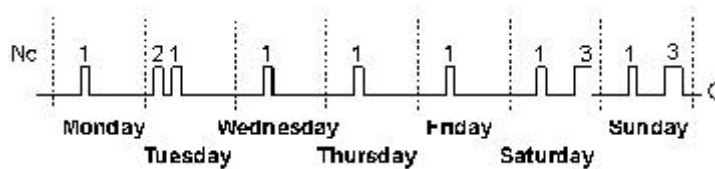

- No1: Daily: 06:30 h to 08:00 h
- No2: Tuesday: 03:10 h to 04:15 h
- No3: Saturday and Sunday: 16:30 h to 23:10 h

Description of the function

Each weekly timer is equipped with three cams. You can configure a time hysteresis for each individual cam. At the cams you set the on and off hysteresis. The weekly timer sets the output at a certain time, provided it is not already set.

The output is reset at a certain time, provided it is not already reset. A conflict is generated in the weekly timer when the set on time and the set off time at another cam are identical. In this case, cam 3 takes priority over cam 2, while cam 2 takes priority over cam 1.

The switching status of the weekly timer is determined by the status at the No1, No2 and No3 cams.

Days of the week

The prefix "D=" (Day) has the following meaning:

- M: Monday
- T: Tuesday
- W: Wednesday
- T: Thursday
- F: Friday

On-/Off-times

Any time between 00:00 h and 23:59 h is possible. You can also configure the on time to be a pulse signal. The timer block will be activated at the specified time for one cycle and then the output is reset.

- :- - means: No on-/off-times set.

Setting the weekly timer

To set the on-/off-times:

1. Move the cursor to one of the Cam parameters of the timer (e.g. No1).
2. Press OK. FLC opens the Cam parameter assignment screen form. The cursor is positioned on the day of the week.
3. Press ▲ and ▼ to select one or several days of the week.
4. Press ► to move the cursor to the first position of the on-time.
5. Set the on-time.

Modify the value at the respective position, using the keys ▲ and ▼. Move to the cursor to the various positions, using the keys ◀ and ▶. At the first position, you can only select the value - :- -

(- :- - means: No on-/off-times set).

6. Press ► to move the cursor to the first position of the off-time.
7. Set the off-time (in same way as in step 5).
8. Confirm your entries with **OK**.

The cursor is now positioned on the No2 parameter (Cam2) and you can configure a further cam.

Special characteristics to note when configuring

The block properties window offers a tab for each one of the three cams. Here you can set the weekly on times for the cams. Each tab offers you in addition an option of defining the on and off times for each cam in hour and minute units. Hence, the shortest switching cycle is one minute.

You can disable the on and off times individually, i.e. you can achieve switching cycles extending across more than one day, for example, by setting the on time for cam 1 to Monday 7:00 h and the off time of cam 2 to Wednesday 13:07 h, while disabling the on time for cam 2.

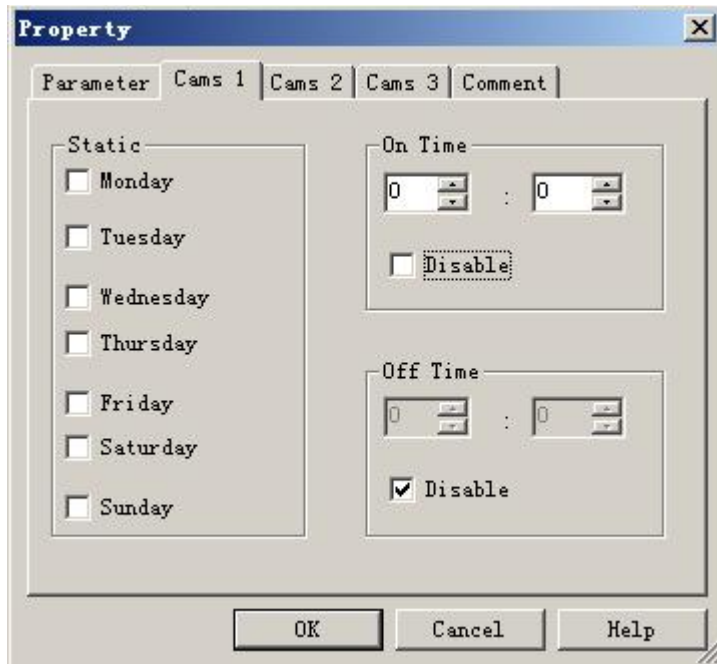

Backup of the real-time clock

The internal real-time clock of FLC is buffered against power failure. The buffering time is influenced by the ambient temperature, and is typically 100 hours at an ambient temperature of 25°C.

5.5.12 Yearly timer

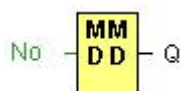

Caution

Your FLC must be equipped with an internal real-time clock if you are going to use this SFB.

Short description

The output is controlled by means of a configurable on/off date.

Connection	Description
Parameter	At the No (cam) parameter you set the on and off trigger

	for the cam of the yearly timer.
Output Q	Q is set on when the configured cam is switched on.

Parameter

The on and off trigger for the cam of the yearly timer can be set/modified in parameter mode and you can configure what you need. For information about how to modify, refer to chapter

Timing diagrams

Example 1: Yearly mode on, Monthly mode off, Pulse Off, On Time = 2000-06-01, Off Time = 2099-08-31: Every year on June 1 the timer output switches on and remains on until August 31.

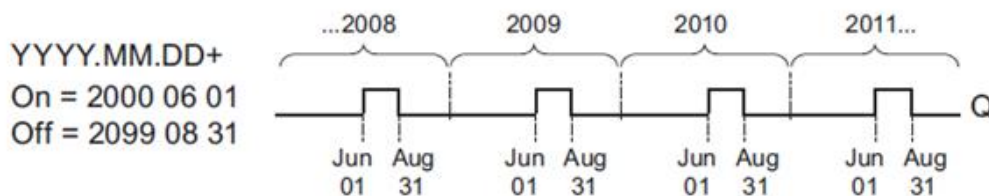

Example 2: Yearly mode on, Monthly mode off, Pulse on, On Time = 2000-03-15, Off Time = 2099-**-**: Every year on March 15, the timer switches on for one cycle.

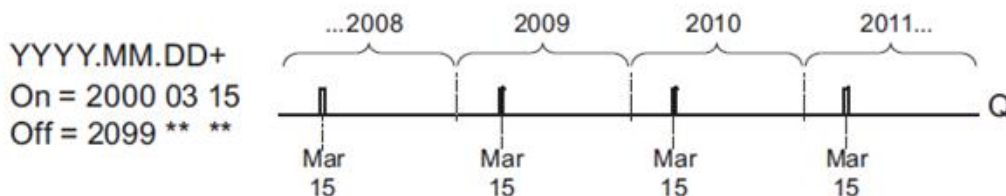

Example 3: Yearly mode on, Monthly mode off, Pulse off, On Time = 2008-06-01, Off Time = 2010-08-31: On June 1 of 2008, 2009, and 2010 the timer output switches on and remains on until August 31.

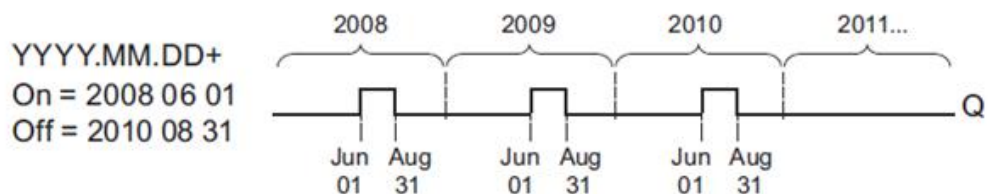

Example 4: Yearly mode on, Monthly mode off, Pulse on, On Time = 2008-03-15, Off Time = 2010-**-**: On March 15 of 2008, 2009, and 2010, the timer output switches on for one cycle.

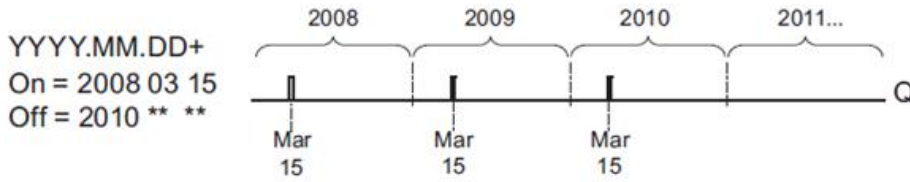

Example 5: Yearly mode off, Monthly mode off, Pulse off, On Time = 2008-06-01, Off Time = 2008-08-31: On June 1, 2008 the timer output switches on and remains on until August 31, 2010.

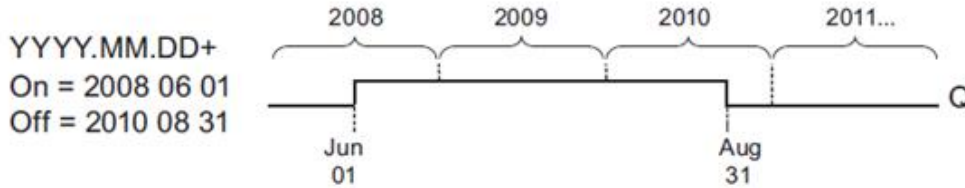

Example 6: Yearly mode off, Monthly mode off, Pulse selected, On Time = 2008-03-15, Off Time = ****-**-**: On March 15, 2008 the timer output switches on for one cycle. Because the timer does not have a monthly action or yearly action, the timer output pulses only one time at the specified On Time.

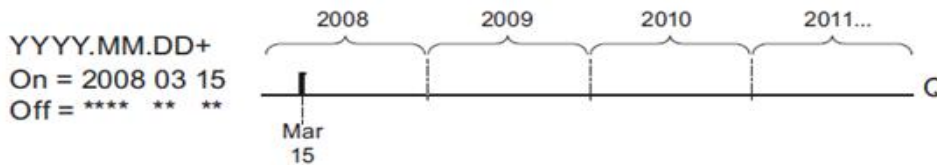

Example 7: Yearly mode on, Monthly mode off, Pulse off, On Time = 2008-12-15, Off Time = 2010-01-07: On December 15 of 2008 and 2009, the timer output switches on and remains on until January 7 of the following year. When the timer output turns off on January 7, 2010 it does NOT turn on again the following December 15.

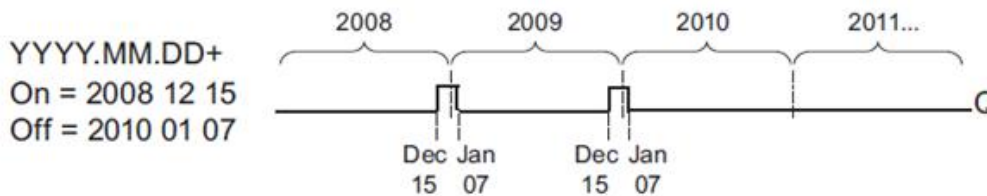

Example 8: Yearly mode on, Monthly mode on, On Time = 2008-**-01, Off Time = 2010-**-05: Starting in 2008, on the first day of each month the timer output switches on and switches off on the fifth day of the month. The timer continues in this pattern through the last month of 2010.

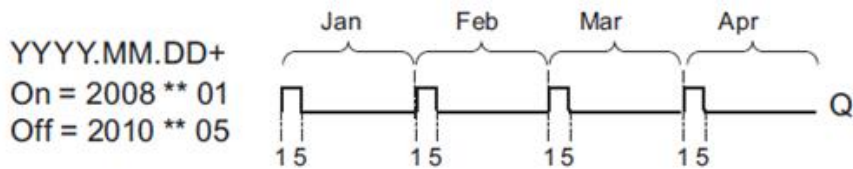

Description of the function

The yearly timer sets and resets the output at specific on and off times.

The off-date identifies the day on which the output is reset again. The first value defines the month, the second the day.

When you select the every month check box, the yearly clock switches on or off at a certain day of every month.

Backup of the real-time clock

The internal real-time clock of FLC is buffered against power failure. The buffering time is influenced by the ambient temperature, and is typically 100 hours at an ambient temperature of 25°C. Special characteristics to note when configuring.

A click on the dialog box enables direct keyboard input of the month and day values. The values entered may not exceed the logical maximum of the relevant input boxes; otherwise FLC Logic Soft returns an error message.

The **calendar** icon offers you an F&F way of setting the date. It opens a window where you can set the days and months by clicking the relevant buttons.

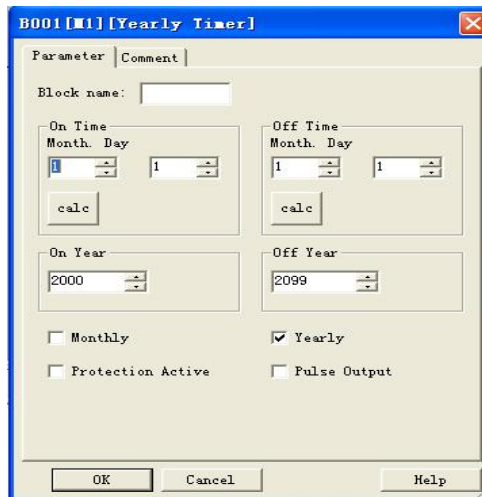

Sample configuration

The output of an FLC is to be set annually on March 1, reset on April 4, set again on July 7, and reset again on November 19. You need to configure two yearly timers with corresponding on-times. Then logically link the outputs by means of an OR block.

B1
MM-DD
On =03-01
Off=04-04

Yearly Timer 1
 On-time Mar 1
 Off-time Apr 4

B2
MM-DD
On =07-07
Off=11-19

Yearly Timer 2
 On-time Jul 7
 Off-time Nov 19

Result

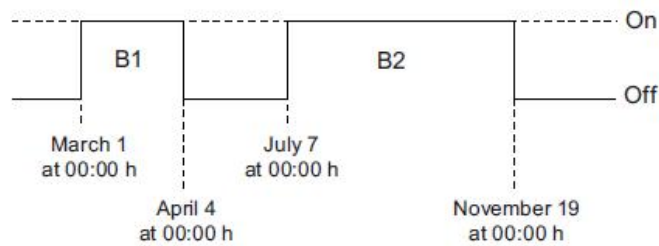

Place two yearly timer switch SFBs on your programming interface and configure the blocks as specified.

On Time Month. Day 3 1 calc	Off Time Month. Day 4 4 calc
On Year 2000	Off Year 2099

On Time Month. Day 7 7 calc	Off Time Month. Day 11 9 calc
On Year 2000	Off Year 2099

Create a logical link of the blocks via a standard OR block. The OR output is 1 if at least one of the yearly timer switches is set.

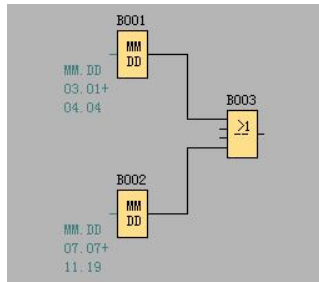

5.5.13 Up/Down counter

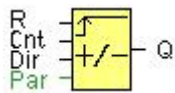

Short description

An input pulse increments or decrements an internal value, depending on the parameter setting. The output is set or reset when a configured threshold is reached. The direction of count can be changed with a signal at input Dir.

Connection	Description
Input R	You reset the output and the internal counter value to zero with a signal at input R (Reset).
Input Cnt	This function counts the 0 to 1 transitions at input Cnt. It does not count 1 to 0 transitions.
Input Dir	Input Dir (Direction) determines the direction of count: Dir = 0: Up Dir = 1: Down
Parameter	On: On threshold Value range: 0...99999999 Off: Off threshold Value range: 0...99999999 StartVal: Initial value from which to begin counting either down or up. Retentivity set (on) = the status is retentive in memory.
Output Q	Q is set and reset according to the actual value at Cnt and the set thresholds.

Parameter

The on threshold On and the off threshold Off can be provided by the value of another already-programmed function:

Analog comparator:	Ax – Ay
Analog trigger:	Ax
Analog amplifier:	Ax
Analog multiplexer:	AQ
Analog ramp:	AQ
Analog math:	AQ
PI controller:	AQ
Data latching relay:	AQ
Up/Down counter:	Cnt

The value of "On", "Off" and "Cnt" can be set/modified in parameter mode. For information about how to modify, refer to chapter

Timing diagram

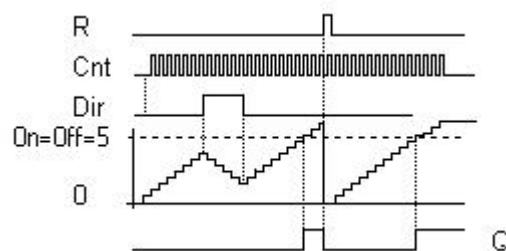

Description of the function

The function increments (Dir = 0) or decrements (Dir = 1) the internal counter by one count with every positive edge at input Cnt.

You can reset the internal counter value to '000000', with a signal at the reset input R. As long as R=1, the output is 0 and the pulses at input Cnt are not counted.

Output Q is set and reset according to the actual value at Cnt and the set thresholds. See the following rules for calculation.

Calculation rule

If the on threshold \geq off threshold, then:

Q = 1, if Cnt \geq On

Q = 0, if Cnt < Off.

If the on threshold < off threshold, then:

Q = 1, if On \leq Cnt < Off.

Caution

The function polls the limit value of the counter once in each cycle.

Thus, if the pulses at the fast inputs are faster than the scan cycle time, the SFB might not switch until the so specified limit has been exceeded.

Example: Up to 100 pulses per cycle can be counted; 900 pulses have been counted so far. On = 950; Off = 10000. The output is set in the next cycle, after the value has reached 1000.

The output would not be set at all if the value Off = 980

5.5.14 Hours counter

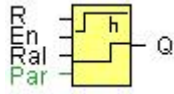

Short description

A configured time is triggered with a signal at the monitoring input. The output is set when this time has expired.

Connection	Description
Input R	A positive edge (0 to 1 transition) at input R resets output Q and sets a configured value MI at the counter for the duration of the time-to-go (MN).
Input En	En is the monitoring input. FLC scans the on-time of this input.
Input Ral	A positive edge at input Ral (Reset all) resets both the hours counter (OT) and the output, and sets the configured value MI at the counter to for the duration of the time-to-go (MN). That is, <ul style="list-style-type: none"> • Output Q = 0, • The measured operating hours OT = 0, and • The time-to-go of the maintenance interval MN = MI.
Parameter	<p>MI: Maintenance interval to be specified in hour units Range of values: 0000...9999 h</p> <p>OT: Expired total operation time. An offset can be specified. Range of values: 00000...99999 h</p> <p>Q 0:</p> <ul style="list-style-type: none"> • When "R" is selected: Q = 1, if MN = 0; Q = 0, if R = 1 or Ral = 1 • When "R+En" is selected: Q = 1, if MN = 0; Q = 0, if R = 1 or Ral = 1 or En = 0.
Output Q	The output is set when the time-to-go MN = 0. The output is reset: <ul style="list-style-type: none"> • When "Q 0:R+En", if R = 1 or Ral = 1 or En = 0 • When "Q 0:R", if R = 1 or Ral = 1.

Timing diagram

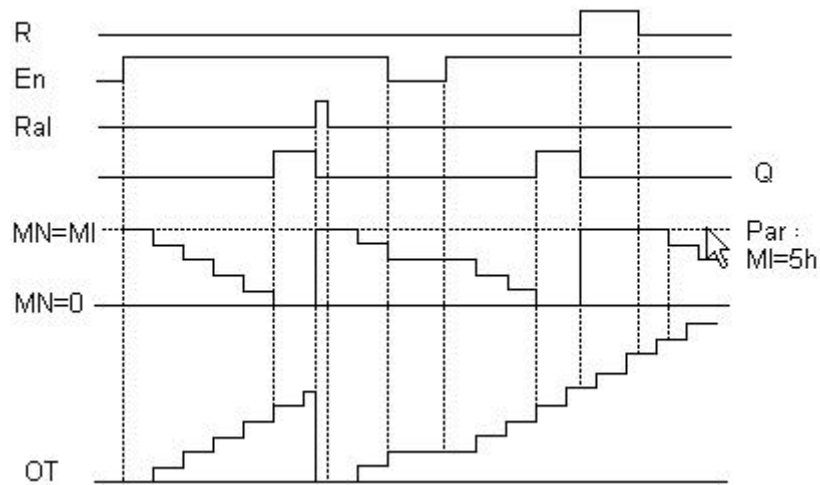

MI = Configured time interval

MN = Time-to-go

OT = Total time expired since the last 1 signal at the Ral input

These values are principally held retentive!

Parameter

The maintenance interval MI can be provided by the actual value of another already-programmed function:

Analog comparator:	Ax - Ay
Analog trigger:	Ax
Analog amplifier:	Ax
Analog multiplexer:	AQ
Analog ramp:	AQ
Analog math:	AQ
PI controller:	AQ
Data latching relay:	AQ
Up/Down counter:	Cnt

The value of "MI" can be set and modified in parameter mode. For information about how to modify, refer to chapter

Description of the function

The hours counter monitors input En. As long as the status at this input is 1, FLC calculates the time expired and the time-to-go MN. FLC displays these times when set to configuration mode. The output is set to 1 when the time-to-go is equal to zero.

You reset output Q and the time-to-go counter to the specified value MI with a signal at input R. The operation hour counter OT remains unaffected.

You reset output Q and the time-to-go counter to the specified value MI with a signal at input RaI. The operation hour counter OT is reset to 0.

Depending on your configuration of the Q parameter, the output is either reset with a reset signal at input R or RaI, or when the reset signal is 1 or the En signal is 0.

Limit value of OT

The values of the operating hours in OT are retained when you reset the hours counter with a signal at input R. The hours counter OT continues the count as long as En = 1, irrespective of the status at the reset input R. The counter limit of OT is 99999 h. The hours counter stops when it reaches this value.

Parameter preset

In FLC Logic Soft, you can define MI and an OT start value.

You determine that Q does not depend on En by selecting the corresponding check box.

Retentivity with the hours counter

The hours counter in the FLC is generally retentive.

However, if the values of the hours counter are lost after a power failure, then select the respective block in your circuit program. Right mouse click on the hours counter and select Block Properties > Parameters. The option Retentivity must be activated and not changeable (grayed out).

If the **Retentivity** option is not available, then delete the block and insert a new special function **hours counter** at the same position.

5.5.15 Threshold trigger



Short description

The output is switched on and off, depending on two configurable frequencies.

Connection	Description
Input Fre	The function count 0 to 1 transitions at input Fre. ! to 0 transitions are not counted. Use <ul style="list-style-type: none"> • Inputs I5, I6 (14KHZ) I7, I8 (60kHz) for FLC12 CPU, Inputs I9, IA (14kHz) IB, IC (60kHz) for upgraded FLC18 CPU • Any other input or circuit element for low frequencies (typical 4 Hz).
Parameter	On: On threshold Range of values: 0000...9999 Off: Off threshold Range of values: 0000...9999 G_T: Time interval or gate time during which the input pulses are measured. Range of values: 00:05 s...99:99 s
Output Q	Q is set or reset according to the threshold values.

Parameter

The gate time G_T can be provided by the actual value of another already-programmed function:

- Analog comparator: Ax – Ay
- Analog trigger: Ax
- Analog amplifier: Ax
- Analog multiplexer: AQ
- Analog ramp: AQ
- PI controller: AQ
- Up/Down counter: Cnt
- Data latching relay: AQ
- Analog Math: AQ

The value of "On", "Off" can be set/modified in parameter mode. For information about how to modify, refer to chapter

Timing diagram

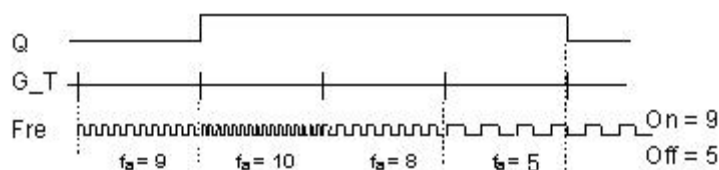

fa = Input frequency

Description of the function

The trigger measures the signals at input Fre. The pulses are captured during a configurable period G_T. Q is set or reset according to the set thresholds. See the following calculation rule.

Calculation rule

If the threshold (On) > threshold (Off), then:

Q = 1, if fa >= On

Q = 0, if fa < Off.

If the threshold (On) < threshold (Off), then Q = 1, if

On <= fa < Off.

5.5.16 Latching relay



Short description

A signal at input S sets output Q. A signal at input R resets output Q.

Connection	Description
Input S	Set output Q with a signal at input S (Set).
Input R	Reset output Q with a signal at input R (Reset). Output Q is reset if S and R are both set (reset has priority over set).
Parameter	Retentivity set (on) = the status is retentive in memory.
Output Q	Q is set with a signal at input S and remains set until it is reset with signal at input R.

No parameter of Latching relay can be set/modified in parameter mode .

Timing diagram

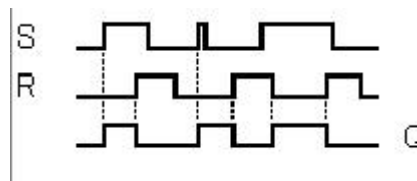

Description of the function

The latching relay represents a simple binary memory logic. The output value depends on the input states and the previous status at the output.

Logic table of the latching relay:

S	R	Q	Remark
0	0	x	Status unchanged
0	1	0	Reset
1	0	1	Set
1	1	0	Reset

When retentivity is enabled, the output signal corresponds with the signal status prior to the power failure.

5.5.17 Pulse relay

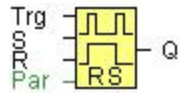

Short description

The output is set and reset with a short one-shot at the input.

Connection	Description
Input Trg	You switch output Q on or off with a signal at input Trg (Trigger) input.
Input S	A one-shot at input S (Set) sets the output to logical 1.
Input R	A one-shot at input R (Reset) resets the output to logical 0
Parameter	<p>Selection:</p> <p>RS (input R priority), or SR (input S priority)</p> <p>Retentivity set (on) = the status is retentive in memory.</p>
Output Q	Q is switched on with a signal at Trg and is reset again at the next Trg pulse, if both S and R = 0.

No parameter of Latching relay can be set/modified in parameter mode.

Timing diagram

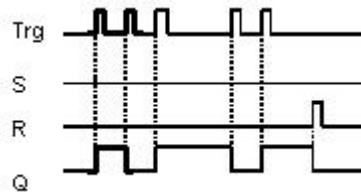

Description of the function

The status of output Q changes with each 0 to 1 transition at input Trg and if both S and R = 0, i.e. the output is switched on or off.

Input Trg does not influence the SFB when S = 1 or R = 1.

A one-shot at input S sets the pulse relay, i.e. the output is set to logical 1.

A one-shot at input R resets the pulse relay to its initial state, i.e. the output is set to logical 0.

Either the input R takes priority over input S (i.e. the signal at input S has no effect as long as R = 1), or the input S takes priority over input R (i.e. the signal at input R has no effect as long as S = 1), depending on your configuration.

5.5.18 Message text

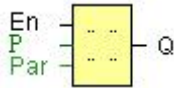

Short description

Display parameterized message texts and parameters of other blocks in RUN mode.

Connection	Description
Input En	A 0 to 1 transition at En (Enable) triggers the output of the message text.
Input P	P is the priority of the message text. 1 is the lowest, 32 is the highest priority. Quit: Acknowledgement of the message text
Parameter	Text: Input of the message text Par: Parameter or actual value of another, already configured function (see "Visible parameters or actual values") Time: Shows the continuously updated time-of-day Date: Shows the continuously updated date EnTime: Shows the time of the 0 to 1 transition
	EnDate: Shows the 0 to 1 transition of the date
Output Q	Q remains set as long as the message text is queued.

Description of the function

With a 0 to 1 transition of the signal at input En, the display outputs your configured message text (actual value, text, TOD, date) in RUN mode.

Acknowledgement disabled (Ack = Off):

The message text is hidden with a 0 to 1 signal transition at input En.

Acknowledgement enabled (Ack = On):

After input En is reset to 0, the message text is displayed until acknowledged by pressing the OK button.

The message text cannot be acknowledged as long as input En is high.

If several message text functions were triggered with En=1, the message with the highest priority (1 = lowest, 64=highest) is displayed. This also implies that a new message text is only displayed if its priority is higher than that of previously enabled message texts.

After a message text is disabled or acknowledged, the function automatically shows the previously active message text that takes the highest priority.

You can press the ▲ and ▼ keys to step through multiple active message texts.

Example

This is how two message texts could be shown:

Display field of FLC in RUN mode

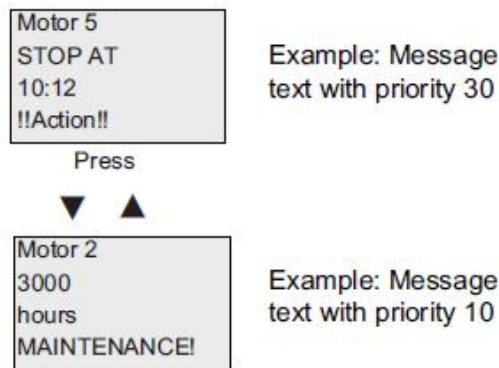

Input P configuration

From the input P, you configure the following characteristics of the message text:

- Priority
- Acknowledgement
- Message destination

Restrictions

Up to 64 message text functions are available.

Particular characteristics to be noted when configuring

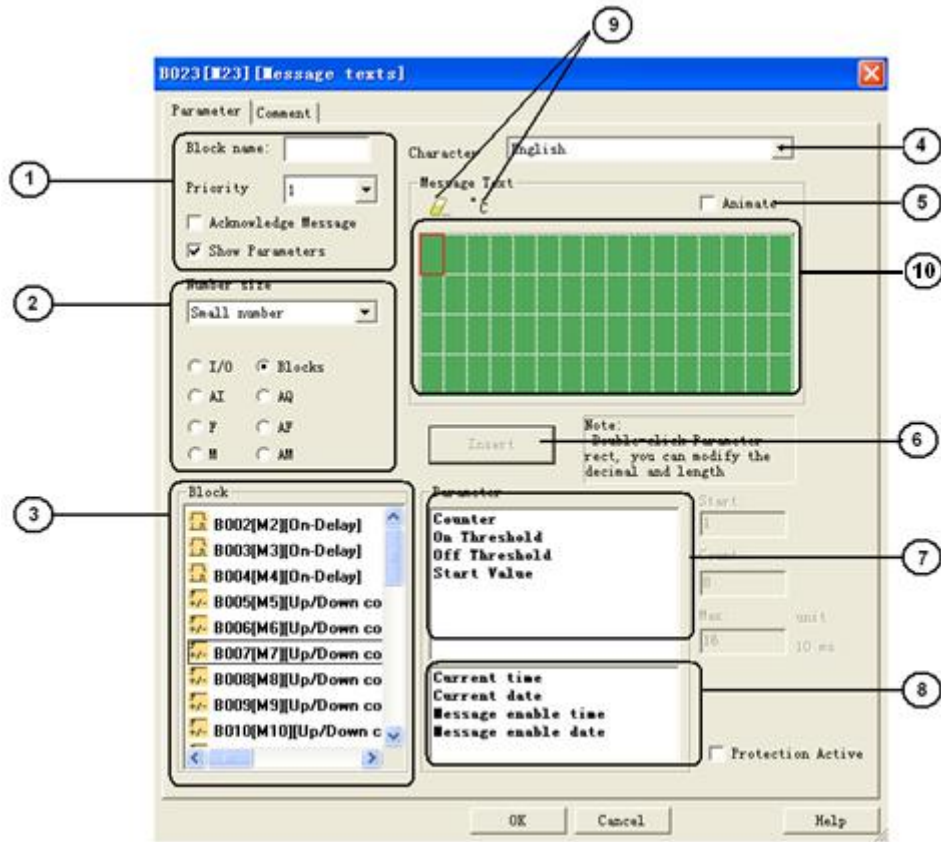

1	<p>"General" area</p> <p>Here you will find the following settings:</p> <ul style="list-style-type: none"> • Priority of the message text • Check box for message text acknowledgement
2	<p>Kinds of parameters and the number size selection area</p> <p>IO status, analog IO values analog flags and blocks can be inserted into LCD for displaying.</p>
3	<p>"Blocks" area</p> <p>Shows a list of all the circuit program blocks and their parameters.</p>
4	<p>Language selection</p>

6	<p>"Insert" button</p> <p>Button for inserting a parameter selected from the "Block parameters" area.</p> <p>"Block parameters" or "General parameters" area into the message text.</p>
7	<p>"Block parameters" area</p> <p>Shows the parameters of a block selected from the "Blocks" area which you can output in the message text.</p>
8	<p>"General parameters" area</p> <p>Shows general parameters such as the current date.</p>
9	<p>"Delete" button</p> <p>Button for deleting entries from the "Messages" area</p> <p>"Special characters" button</p> <p>Button for inserting special characters in the "Messages" area</p>
10	<p>"Messages" area</p> <p>You arrange the message text in this area. Information entered in this area corresponds with that on the FLC display.</p>

To arrange the message text

From the "Blocks" area, select the block whose parameters you want to output. Drag and drop the parameters required from the "Block parameters" to the "Messages" area. You may also use the "Insert" button to do so. In the "Messages" area, you can add parameter data as required.

Particular characteristics to be noted when configuring

The message text can be configured in the block properties dialog. You can enter up to 4 lines for each message text (the text display of the FLC has 4 x 16 characters) and set the priority. You can move to the next line using the cursor keys or the mouse. Hit the [ENTER] key to confirm all your entries in the block properties dialog and to close the dialog. You may also enter the actual values of other blocks in the text lines. To do so, select the relevant block from the Block dialog. A Parameter dialog opens to display a list of all parameters available for the selected block. The block parameter you select in this dialog is written to the selected text line. The actual parameter value is now included when you call the message text.

Set the "Acknowledge message" attribute to specify whether a message is be acknowledged before it is closed.

A. I/O status of CPU and extensions

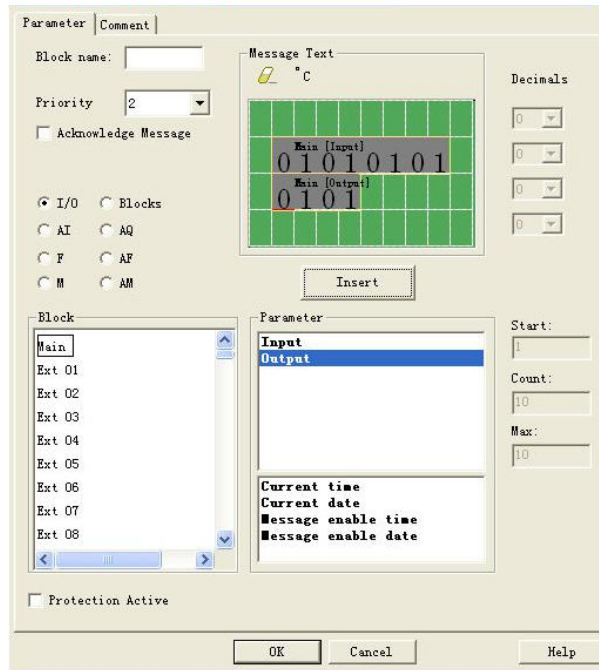

B. Blocks

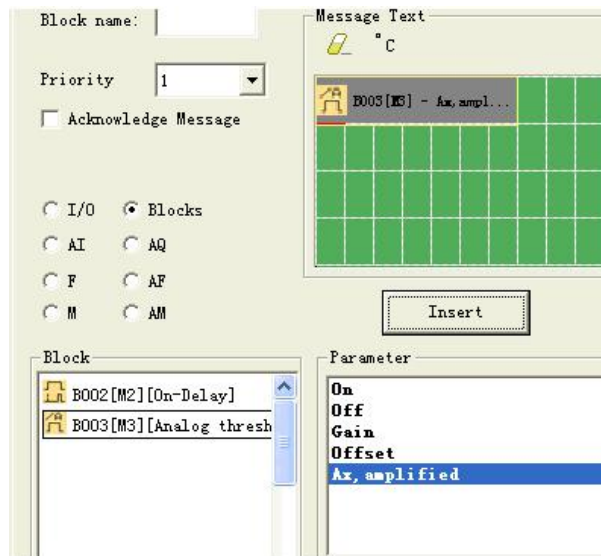

C. Analog input value of CPU and extensions

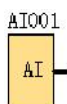

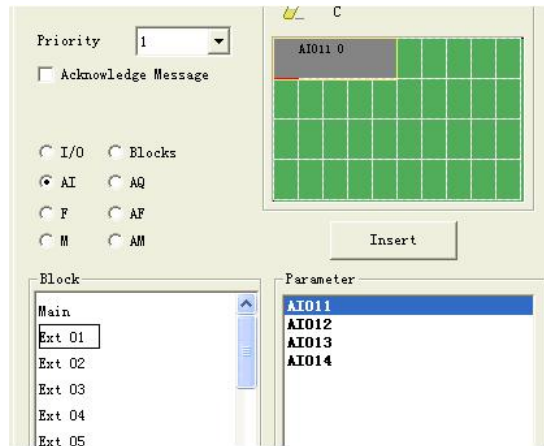

D. Analog output value of CPU and extensions

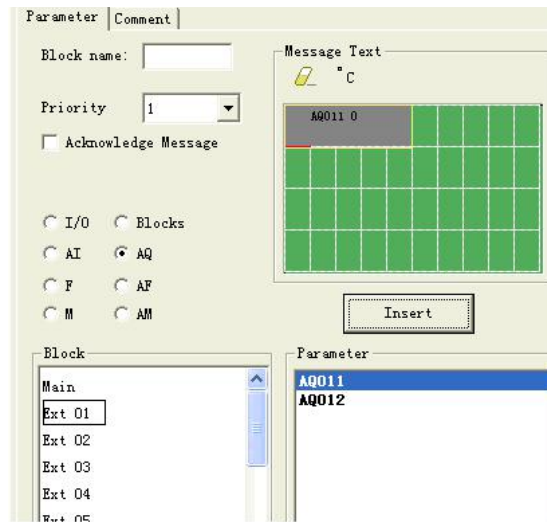

E. F (digital flag) status

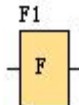

Block name:

Priority: 1

Acknowledge Message

I/O Blocks

AI AQ

F AF

M AM

Message Text: °C

AQ011 0

F15--F20
01010

Decimals: 0, 0, 0, 0

Insert

Block: F1---F64

Parameter: F1--F64

Start: 15

Count: 5

Max: 10

Current time
Current date
Message enable time
Message enable date

Here is start number of "F"

Here is the counting of "F"

Such configuration is to display the status of "F15---F20"

F. AF (analog flag) value



Parameter | Comment

Block name:

Priority: 1

Acknowledge Message

I/O Blocks

AI AQ

F AF

M AM

Message Text: °C

AF7 0

Decimals: 0, 0, 0, 0

Insert

Block: AF1, AF2, AF3, AF4, AF5, AF6, AF7, AF8, AF9

Parameter: AF

Start: 15

Count: 5

Max: 10

Current time
Current date
Message enable time
Message enable date

Here is start number of "AF"

Here is the counting of "AF"

Such configuration is to display the status of "AF7"

G. M status

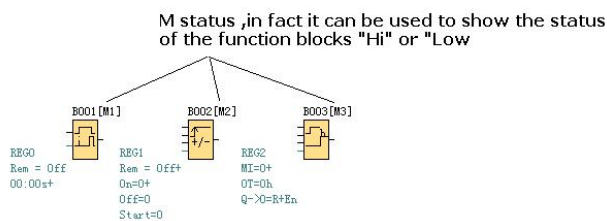

H. AM value

AM value ,it can be used to display the current value of analog blocks which has analog output pin .

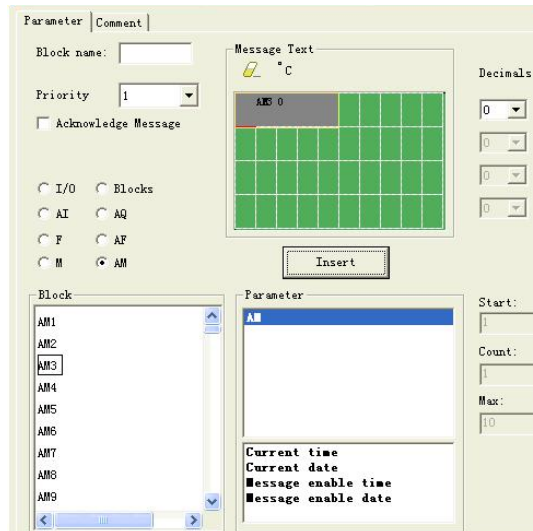
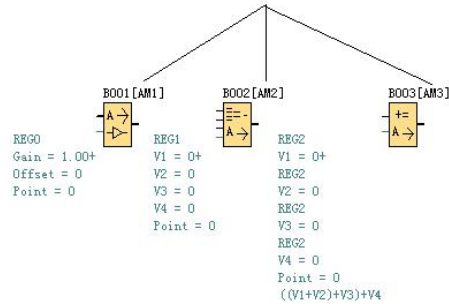

With text message, the text can display big number (6 bits or 4 bits). (This feature only can be used in FLC-12 CPU).

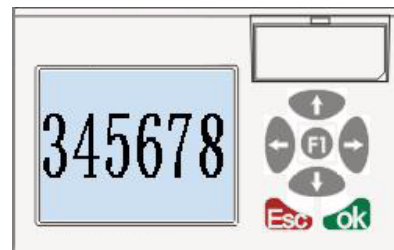
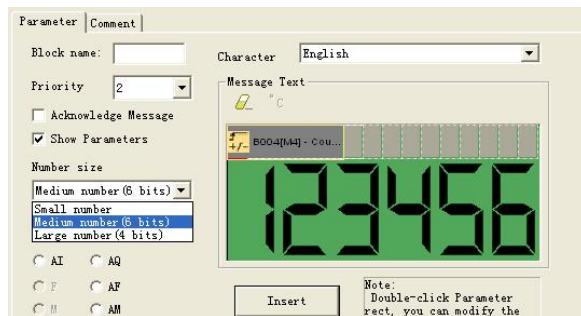

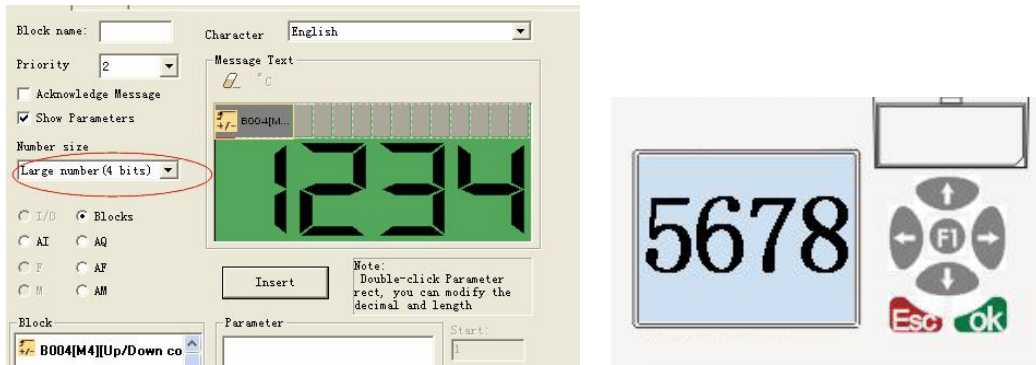

5.5.18.1 How to change parameters of blocks in displayed message?

Parameters of blocks can be changed in displayed message if inserted into the "message text" block by press "OK" key for 3 seconds.

Step as follows:

- A. Insert the parameters of block into message text. (Here is On-delay).

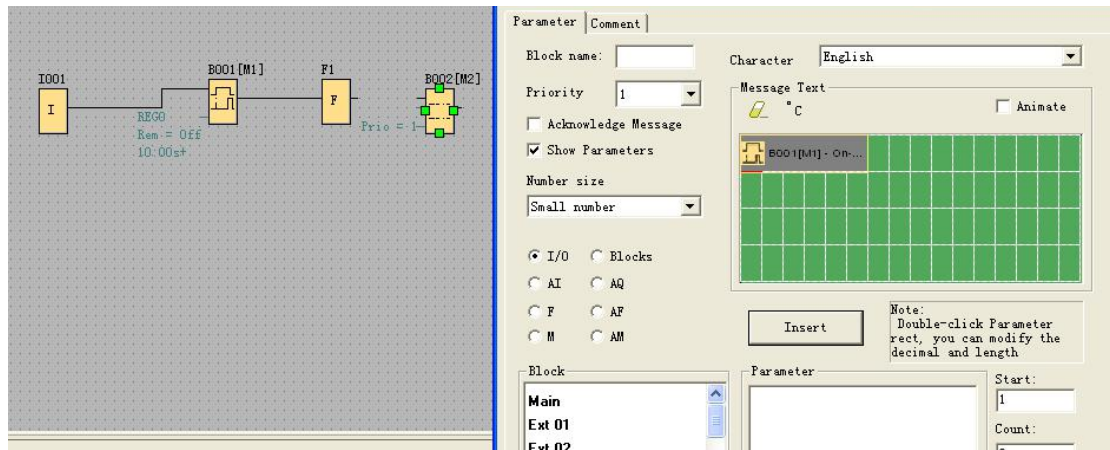

B. Change the page to display the message text contents by arrow keys.

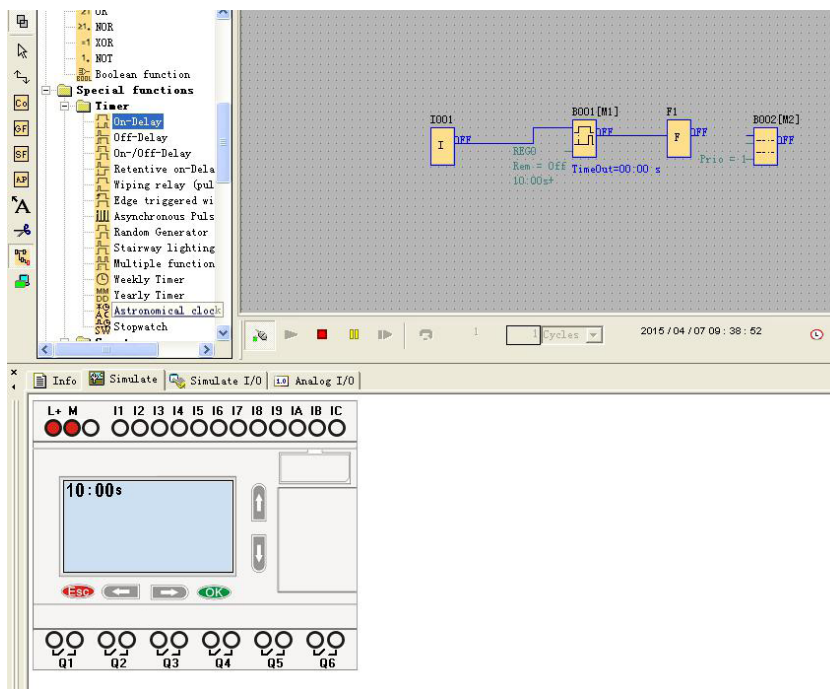

C. Press "ok" for 3 seconds and enter into edit mode.

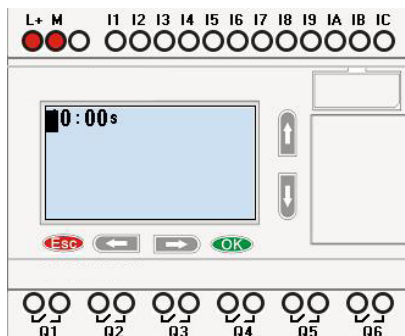

D. Modify value by pressing arrow keys and confirm with OK key.

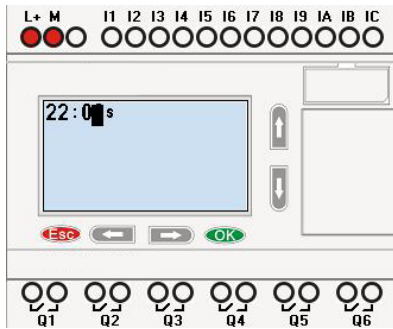

5.5.19 Softkey

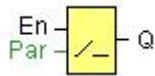

Short description

This SFB provides the action of a mechanical pushbutton or switch.

Connection	Description
Input En	Output Q is set with a 0 to 1 signal transition at input En (Enable) and if, in addition, 'Status=On' has been confirmed in configuration mode.
Parameter	Type: Sets either a pushbutton action for one cycle or a switching action of the function. Status: On or Off state that is applied in the initial cycle after program startup, is retentivity is not set. Retentivity set (on) = the status is retentive in memory.
Output Q	Output Q remains set 1, as long as En=1 and the status at the parameter Type = Switch and Status = On. Output Q is set for the duration of one cycle if EN=1 and the status at the parameters Type = momentary (pushbutton) and Status = On.

Factory state

Default of 'Type' is 'momentary action switch'.

Timing diagram

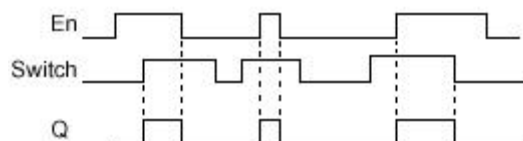

Description of the function

The output is set, when input En is set and the 'Status' parameter is set to 'On' and confirmed with OK. This action is performed irrespective of a configured switch or pushbutton function.

The output is reset to '0' in the following three cases:

- With a 1 to 0 signal transition at input En.
- When a pushbutton function is configured and one cycle has expired after its actuation.
- When the 'Status' parameter sets the 'Off' status in configuration mode, and this has been confirmed with OK.

Particular characteristics to be noted when configuring

The softkey can be used both with momentary push button or switching action. At the status parameter you can define the on (actuated) or off state for the switch/push button.

If the softkey is assigned a push button action, the output is always set for the duration of one cycle with a 0 to 1 transition at input En when the push button is in on state, or if the push button state changes from Off to On when En=1.

Parameters of softkey in message texts block:

- 1.The "ok" means you can press the ok button to switch the status of the softkey block after its parameter inserted into message texts.
- 2.The "Esc" means you can press the ESC button to switch the status of the softkey block after its parameter inserted into message texts.
- 3.The status of softkey block is also can be inserted into the message texts block for displaying.

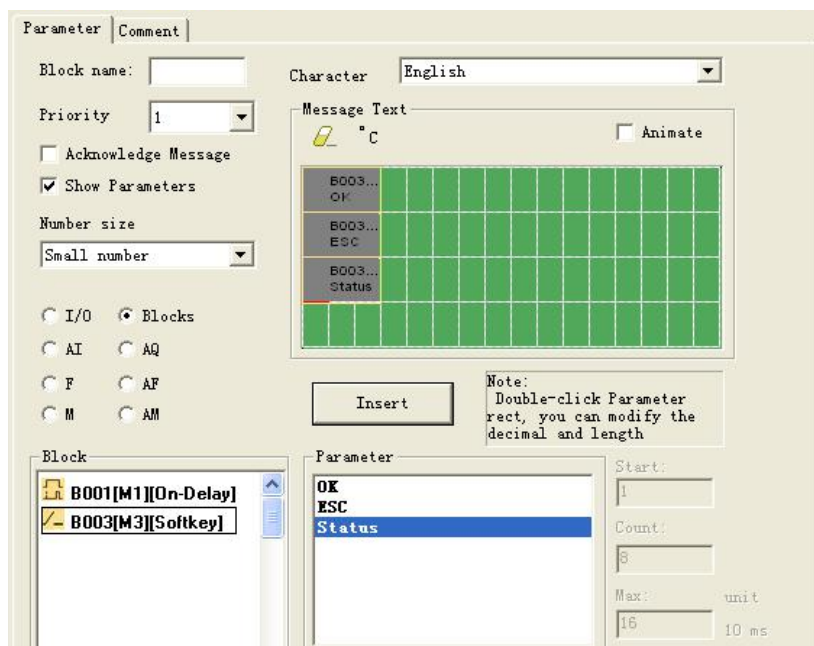

5.5.20 Shift register

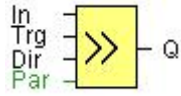

Short description

The shift register function can be used to read an input value and to shift the bits. The output value corresponds with the configured shift register bit. The shift direction can be changed at a special input.

Connection	Description
Input In	The function when started reads this input value.
Input Trg	The SFB is started with a positive edge (0 to 1 transition) at input Trg (Trigger). A 1 to 0 transition is irrelevant.
Input Dir	You define the shift direction of the shift register bits S1...S8 at the Dir input: Dir = 0: shift up (S1 >> S8) Dir = 1: shift down (S8 >> S1)
Parameter	Shift register bit that determines the value of output Q. Possible settings: S1 ... S8 Retentivity set (on) = the status is retentive in memory.
Output Q	The output value corresponds with the configured shift register bit.

Timing diagram

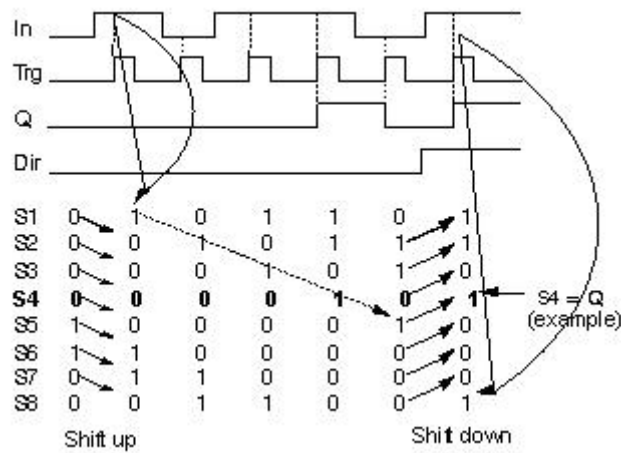

Setting the Par parameter

This special function is not available in parameter assignment mode.

Description of the function

The function reads the value of input In with a positive edge (0 to 1 transition) at input Trg (Trigger). This value is written to shift register bits S1 or S8, depending on the set shift direction:

- Shift up: S1 accepts the value of input In; the previous value of S1 is shifted to S2, S2 is shifted to S3, etc.
- Shift down: S8 accepts the value of input In; the previous value of S8 is shifted to S7, S7 is shifted to S6, etc.

Q outputs the value of the configured shift register bits.

If retentivity is not enabled, the shift function restarts at S1 or S8 after a power failure.

Note

The special function shift register can be used only once in the circuit program.

5.5.21 Analog comparator

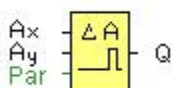

Short description

The output is set and reset depending on the difference $A_x - A_y$ and on two configurable thresholds.

Connection	Description
Inputs Ax, Ay	Input the analog signals of which you want to determine the delta at the inputs Ax and Ay. Use the analog inputs AI1...AI8, the analog outputs AQ1 and AQ2. AI1..AI8: 0 - 10 V corresponds with 0 - 1000 (internal value).
Parameter	A: Gain Range of values: ± 10.00 B: Zero offset Range of values: $\pm 10,000$ On: On threshold Range of values: $\pm 20,000$ Off: Off threshold Range of values: $\pm 20,000$ p: Number of decimals Range of values: 0, 1, 2, 3
Output Q	Q is set or reset depending on the set thresholds.

Parameter p (number of decimals)

The on threshold On and the off threshold Off can be provided by the actual value of another already-programmed function:

- Analog comparator: Ax – Ay
- Analog trigger: Ax
- Analog amplifier: Ax
- Analog multiplexer: AQ
- Analog ramp: AQ
- Analog math: AQ
- PI controller: AQ
- Data latching relay: AQ
- Up/Down counter: Cnt

Applies only to Ax, Ay, Delta, On and Off values displayed in a message text.

Does not apply to the comparison of on and off values! (The compare function ignores the decimal point.)

The value of "On", "Off" and "Dec" can be set/modified in parameter mode. For information about how to set/modify, refer to chapter (Dec means decimal point.)

Timing diagram

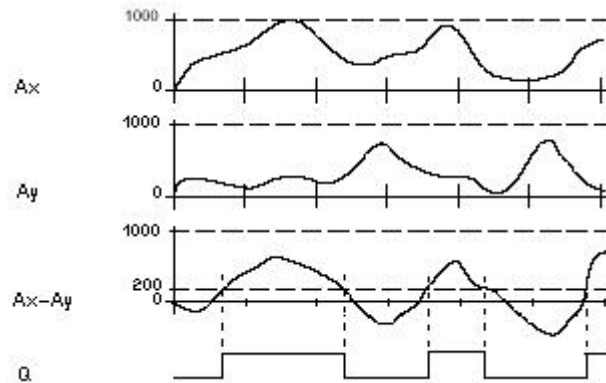

Q for $A_x - A_y > 200$, On = Off = 200

Description of the function

The function reads the value of the signal at the analog input A_x .

This value is multiplied by the value of parameter A (gain). Parameter B (offset) is added to the product, hence

$$(A_x \cdot \text{gain}) + \text{offset} = \text{Actual value } A_x.$$

$$(A_y \cdot \text{gain}) + \text{offset} = \text{Actual value } A_y.$$

Output Q is set or reset depending on the difference of the actual values $A_x - A_y$ and the set thresholds.

See the following calculation rule.

Calculation rule

- If threshold On \geq Threshold Off, then:

$$Q = 1, \text{ if (actual value } A_x - \text{actual value } A_y) > \text{On}$$

$$Q = 0, \text{ if (actual value } A_x - \text{actual value } A_y) \leq \text{Off.}$$

- If threshold On < Threshold Off, then $Q = 1$, falls:

$$\text{On} \leq (\text{actual value } A_x - \text{actual value } A_y) < \text{Off.}$$

Reducing the input sensitivity of the analog comparator

You can delay the output of the analog comparator selectively by means of the "on delay" and "off delay" SFBs. By doing so, you determine that output Q is only set if the input trigger length Trg (= output of the analog comparator) exceeds the defined on delay time.

This way you can set a virtual hysteresis, which renders the input less sensitive to short changes.

Particular characteristics to be noted when configuring

For help on analog block parameters, refer to the Analog value processing section in FLC Logic Soft.

Setting the Par parameter

The gain and offset parameters are used to adapt the sensors to the relevant application.

Example

In a heating control system, the supply T_v and return line temperatures T_r are to be compared, for example with a sensor at AI2.

A control signal is to be triggered (for example "heater On") when the difference between the supply and return line temperatures is greater than 15 °C. The control signal is reset when

the difference is less than 5 °C.

The process variable of the temperature is to be shown in parameter assignment mode.

The thermocouples available have the following technical data: -30 to +70 °C, 0 to 10 VDC.

Application	Internal mapping
-30 to +70 °C = 0 to 10 V DC	0 to 1000
0 °C	300 → Offset = -30
Range of values: -30 to +70 °C = 100	1000 → Gain = 100/1000 = 0.1
On threshold = 15 °C	Threshold = 15
Off threshold = 5 °C	Threshold = 5

Reducing the input response of the analog comparator

You can selectively delay the output of an analog comparator by means of the "On-delay" and "Off-delay" special functions. With on-delay, output Q is only set if the pulse width of the triggering signal at input Trg (=analog comparator output) is longer than the on-delay time. Using this method, you will obtain a virtual hysteresis and reduce the input response to short signals.

Function block diagram

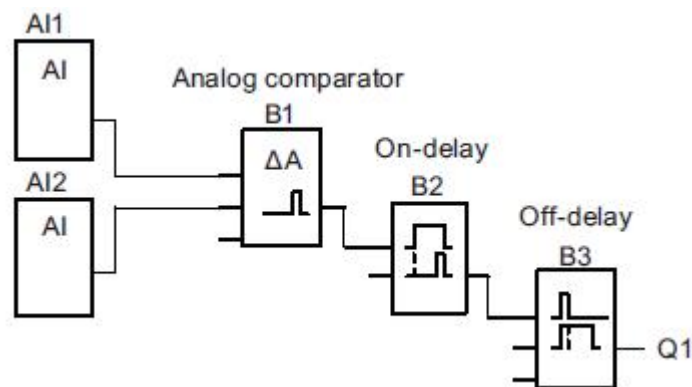

5.5.22 Analog threshold trigger

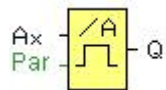

Short description

The output is set or reset depending on two configurable thresholds (hysteresis).

Connection	Description
Input Ax	Input the analog signal to be evaluated at input Ax. Use the analog inputs AI1...AI8, the analog outputs AQ1 and AQ2. 0 - 10 V is proportional to 0 - 1000 (internal value).

Parameter	<p>A: Gain Range of values: ± 10.00</p> <p>B: Zero offset Range of values: $\pm 10,000$</p> <p>On: On threshold Range of values: $\pm 20,000$</p> <p>Off: Off threshold Range of values: $\pm 20,000$</p> <p>p: Number of decimals Range of values: 0, 1, 2, 3</p>
Output Q	Q is set or reset depending on the set thresholds.

Parameter On and Off

The On and Off parameters can be provided by the actual value of another already-programmed function:

- Analog comparator: Ax - Ay
- Analog trigger: Ax
- Analog amplifier: Ax
- Analog multiplexer: AQ
- Analog ramp: AQ
- Analog math: AQ
- PI controller: AQ
- Data latching relay: AQ
- Up/Down counter: Cnt

Applies only to the display of On, Off and Ax values in a message text.

Does not apply to the comparison of On and Off values! (The compare function ignores the decimal point.)

The value of "On", "Off" and "Dec" can be set/modified in parameter mode. For information about how to set/modify, refer to chapter (Dec means decimal point.)

Timing diagram

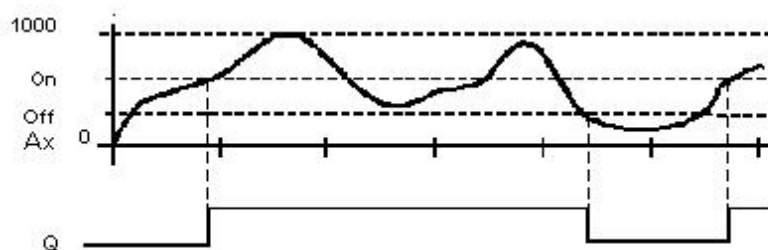

Description of the function

The function reads the value of the signal at the analog input Ax.

This value is multiplied by the value of parameter A (gain). Parameter B (offset) is added to the product, hence

$$(Ax \cdot \text{Gain}) + \text{Offset} = \text{Actual value } Ax.$$

Output Q is set or reset depending on the set threshold values. See the following calculation rule.

Calculation rule

If threshold (On) \geq threshold (Off), then:

Q = 1, if the actual value Ax > On

Q = 0, if the actual value Ax \leq Off.

If threshold (On) < threshold (Off), then Q = 1, if

On \leq the actual value Ax < Off.

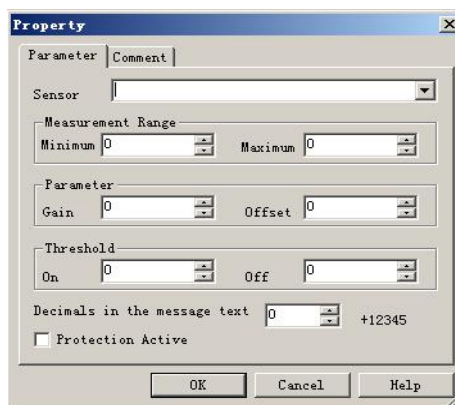

Note

The decimal point setting must be identical in the min. and max. range.

View in parameter assignment mode (example):

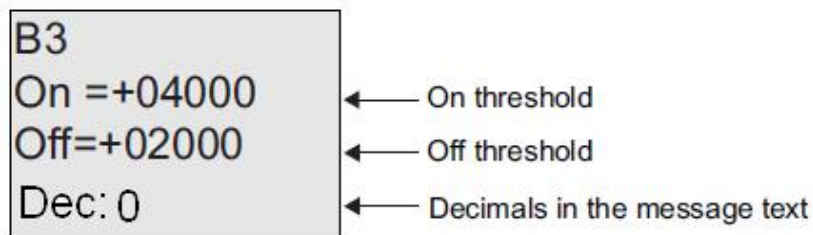

5.5.23 Analog amplifier

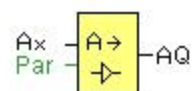

Short description

This SFB amplifies an analog input value and returns it at the analog output.

Connection	Description
Input Ax	Input the analog signal to be amplified at input Ax. Use the analog inputs AI1..AI8, the analog outputs AQ1 and AQ2. AI1..AI8: 0 - 10 V corresponds with 0 - 1000 (internal value).
Parameter	A: Gain Range of values: ± 10.00 B: Zero offset Range of values: ± 10000 p: Number of decimals Range of values: 0, 1, 2, 3
Output AQ	Analog output Value range for AQ: -32768...+32767

Parameter p (number of decimals)

Applies only to the display of Ax and Ay values in a message text.

Does not apply to the comparison of On and Off values! (The compare function ignores the decimal point.)

Description of the function

The function reads the value of an analog signal at the analog input Ax.

This value is multiplied by the gain parameter A. Parameter B (offset) is added to the product, i.e.

$$(Ax \cdot gain) + offset = Actual\ value\ Ax.$$

5.5.24 Analog value monitoring

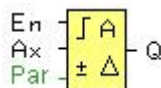

Short description

This special function saves the process variable of an analog input to memory, and sets the output when the output variable exceeds or drops below this stored value plus a configurable offset.

Connection	Description
Input En	A positive edge (0 to 1 transition) at input En saves the analog value at input Ax ("Aen") to memory and starts monitoring of the analog range $Aen \pm \Delta$.
Input Ax	You apply the analog signal to be monitored at input Ax. Use the analog inputs AI1...AI8, the analog outputs AQ1 and AQ2. 0 - 10 V is proportional to 0 - 1000 (internal value).
Parameter	A: Gain Range of values: ± 10.00 B: Zero offset Range of values: $\pm 10,000$ Delta: Difference value for the Aen on/off threshold Range of values: $\pm 20,000$ p: Number of decimals Range of values: 0, 1, 2, 3
Output Q	Q is set/reset, depending on the stored analog value and the offset.

Parameter p (number of decimals)

The two threshold parameters Threshold 1 and Threshold 2 can be provided by the actual value of another already-programmed function:

- Analog comparator: Ax - Ay
- Analog trigger: Ax
- Analog amplifier: Ax
- Analog multiplexer: AQ
- Analog ramp: AQ
- Analog math: AQ
- PI controller: AQ
- Data latching relay: AQ
- Up/Down counter: Cnt

Applies only to the display of Aen, Ax and Delta values in a message text.

Timing diagram

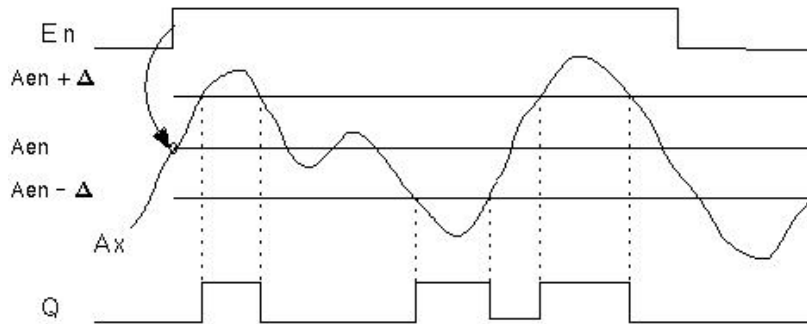

Description of the function

A 0 to 1 transition at input E_n saves the value of the signal at the analog input A_x . This saved process variable is referred to as A_{en} .

Both the analog actual values A_x and A_{en} are multiplied by the value at parameter A (gain), and parameter B (offset) is then added to the product, i.e.

$$(A_x \cdot \text{gain}) + \text{offset} = \text{Actual value } A_{en}, \text{ when input } E_n \text{ changes from 0 to 1, or}$$

$$(A_x \cdot \text{gain}) + \text{offset} = \text{Actual value } A_x.$$

Output Q is set when the signal at input $E_n = 1$ and if the actual value at input A_x is out of range of $A_{en} \pm \Delta$.

Output Q is reset, when the actual value at input A_x lies within the range of $A_{en} \pm \Delta$, or when the signal at input E_n changes to 0.

5.5.25 Analog differential trigger

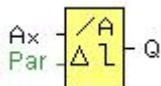

Short description

The output is set and reset depending on a configurable threshold and a differential value.

Connection	Description
Input Ax	You apply the analog signal to be analyzed at input A_x . Use the analog inputs $AI1 \dots AI8$, the analog outputs $AQ1$ and $AQ2$. $0 - 10 \text{ V}$ is proportional to $0 - 1000$ (internal value).

Parameter	<p>A: Gain Range of values: ± 10.00</p> <p>B: Zero offset Range of values: $\pm 10,000$</p> <p>On: On threshold Range of values: $\pm 20,000$</p> <p>Delta: Differential value for calculating the off parameter Range of values: $\pm 20,000$</p> <p>p: Number of decimals Range of values: 0, 1, 2, 3</p>
Output Q	Q is set or reset, depending on the threshold and difference values.

Parameter p (number of decimals)

Applies only to the display of On, Off and Ax values in a message text.

Does not apply to the comparison of On and Off values! (The compare function ignores the decimal point.)

Timing diagram A: Function with negative difference Delta

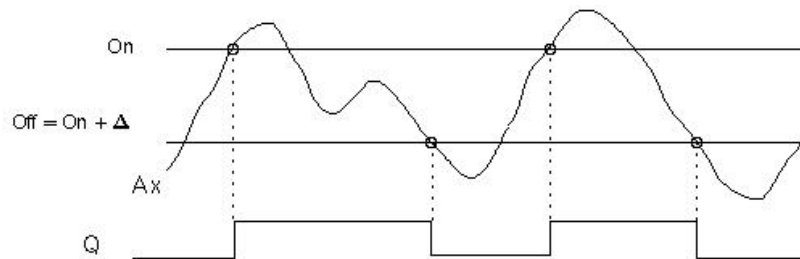

Timing diagram B: Function with positive difference Delta

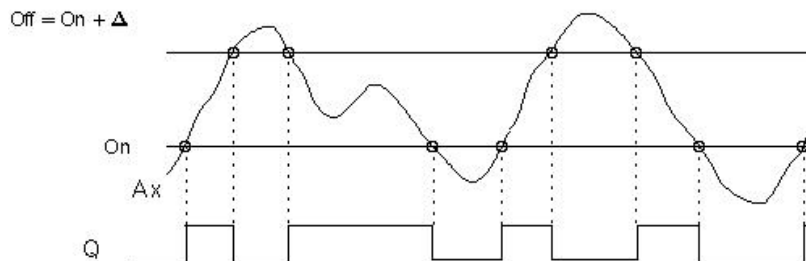

Description of the function

The function fetches the analog signal at input A_x .

A_x is multiplied by the value of the A (gain) parameter, and the value at parameter B (offset) is added to

product, i.e.

$(Ax \cdot \text{gain}) + \text{offset} = \text{actual value of } Ax.$

Output Q is set or reset, depending on the set (On) threshold and difference value (Delta). The function automatically calculates the Off parameter: $\text{Off} = \text{On} + \text{Delta}$, whereby Delta may be positive or negative.

See the calculation rule below.

Calculation rule

When you set a negative differential value Delta, the On threshold \geq Off threshold, and:

$Q = 1$, if the actual value $Ax > \text{On}$

$Q = 0$, if the actual value $Ax \leq \text{Off}$.

See the timing diagram A.

When you set a positive differential value Delta, the On threshold $<$ the Off threshold, and $Q = 1$, if: $\text{On} \leq \text{actual value } Ax < \text{Off}$.

See the timing diagram B.

5.5.26 Analog multiplexer

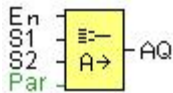

Short Description

This special function displays 0 or one of 4 saved analog values on the analog output.

Connection	Description
Input En	1 on input En (Enable) switches, dependent on S1 and S2, a parameterized analog value to the output AQ. 0 on input EN switches 0 to the output AQ.
Inputs S1 and S2	S1 and S2 (selectors) for selecting the analog value to be issued. S1 = 0 and S2 = 0: The value 1 is issued S1 = 0 and S2 = 1: The value 2 is issued S1 = 1 and S2 = 0: The value 3 is issued S1 = 1 and S2 = 1: The value 4 is issued

Parameter	V1...V4 : Analog values (Value) that will be issued. Value range: -32768...+32767 p : Number of decimal places value range: 0, 1, 2, 3
Output AQ	Analog output Value range for AQ: -32768...+32767

Parameters V1...V4

The values for V1...V4 can be provided by the value of another already-programmed function:

- Analog comparator: Ax - Ay
- Analog trigger: Ax
- Analog amplifier: Ax
- Analog multiplexer: AQ
- Analog ramp: AQ
- Analog math: AQ
- PI controller: AQ
- Data latching relay: AQ
- Up/Down counter: Cnt

Timing diagram

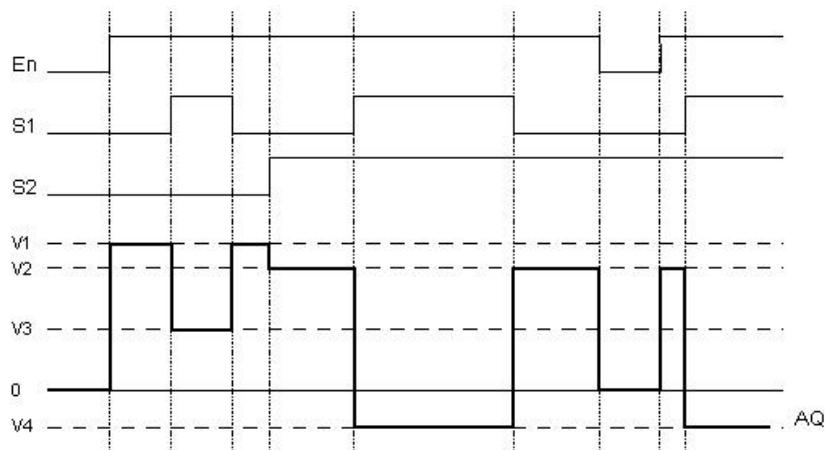

Description of Function

If input En is set, then the function issues one of 4 possible analog values V1 to V4 at the output AQ, depending on the parameters S1 and S2.

If the input En is not set, then the function issues the analog value 0 at output AQ.

Analog output

If you interconnect this special function with a real analog output, note that the analog output can only process values between 0 and 1000. To do this, you may need to connect an additional amplifier between the analog output of the special function and the real analog output. Using this amplifier, you standardize the output range of the special function to a value range of 0 to 1000.

5.5.27 System cover

This block cannot directly be found in the block list ,however, it is set as default by system of FLC (FLogic), hence system cover can be available if you follow the below procedures : use your mouse to left-click "Tools" menu->select "Edit Cover HMI" by left-click in FLC Logic Soft.

Short description

Display the status (Run or Stop) of FLC when power-on or simulation by soft.
Particular characteristics to be noted when configuring.

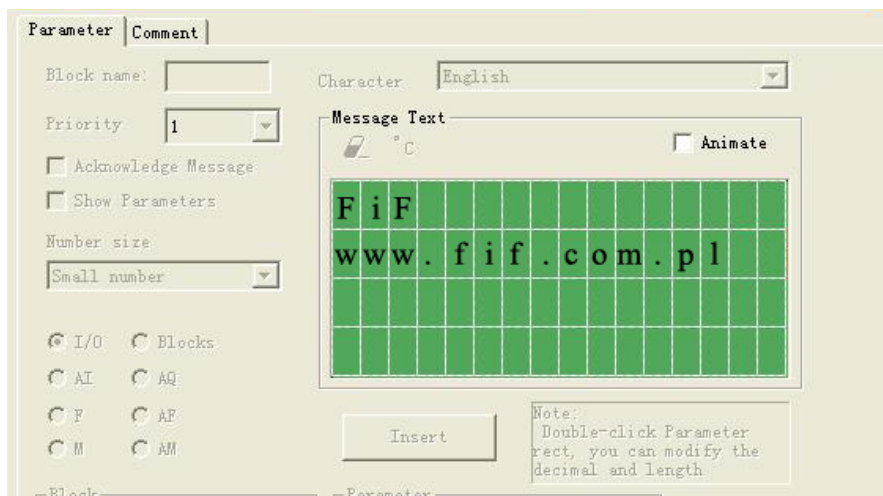

5.5.28 Pulse Width Modulator (PWM)

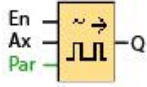

Short Description:

The Pulse Width Modulator (PWM) instruction modulates the analog input value Ax to a pulsed digital output signal. The pulse width is proportional to the analog value Ax.

connection	Description
EN	A positive edge (0 to 1 transition) at input En enables the PWM function block.
Input Ax	Analog signal to be modulated to a pulsed digital output signal.
parameter	<p>A: Gain Range of values: +- 10.00</p> <p>B: Zero offset Range of values: +- 10,000</p> <p>PT: Periodic time over which the digital output is modulated</p> <p>p: Number of decimals Range of values: 0, 1, 2, 3</p>
Output Q	Q is set or reset for the proportion of each time period according to the proportion of the standardized value Ax to the analog value range.

Parameter PT

The periodic time PT can be provided by the actual value of another already-programmed function:

- Analog comparator: Ax – Ay
- Analog trigger: Ax
- Analog amplifier: Ax
- Analog multiplexer: AQ
- Analog ramp: AQ
- PI controller: AQ
- Analog math: AQ
- Data latching relay: AQ
- Up/Down counter: Cnt

Parameter p (number of decimals)

Parameter p applies only to the display of the Ax value in a message text.

Description of the function

The function reads the value of the signal at the analog input Ax.

This value is multiplied by the value of parameter A (gain). Parameter B (offset) is added to the product, as follows:

$$(Ax * Gain) + Offset = Actual\ value\ Ax$$

The function block calculates the proportion of the value Ax to the range. The block sets the digital output Q high for the same proportion of the PT (periodic time) parameter, and sets Q low for the remainder of the time period.

Examples with Timing Diagrams

The following examples show how the PWM instruction modulates a digital output signal from the analog input value:

Example 1

Analog input value: 500 (range 0...1000)

Periodic time T: 4 seconds

The digital output of the PWM function is 2 seconds high, 2 seconds low, 2 seconds high, 2 seconds low and continues in that pattern as long as parameter "En" = high.

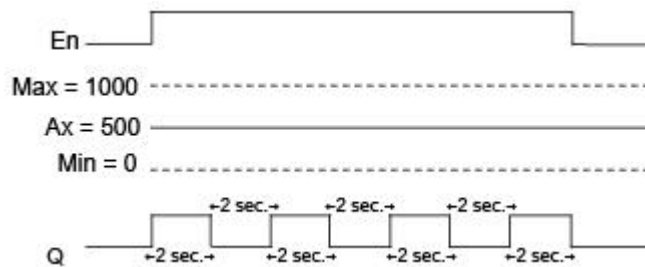

Example 2

Analog input value: 300 (range 0...1000)

Periodic time T: 10 seconds

The digital output of the PWM function is 3 seconds high, 7 seconds low, 3 seconds high, 7 seconds low and continues in that pattern as long as parameter "En" = high.

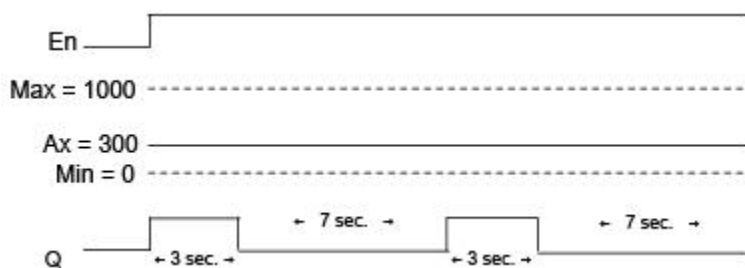

Calculation rule

$Q = 1$, for $(Ax - Min) / (Max - Min)$ of time period PT

$Q = 0$, for $PT - [(Ax - Min) / (Max - Min)]$ of time period PT.

Note: Ax in this calculation refers to the actual value Ax as calculated using the Gain and Offset. Min and Max refer to the minimum and maximum values specified for the range.

5.5.29 Analog Ramp

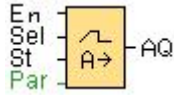

Short Description:

The Analog Ramp instruction allows the output to be changed from the current level to a selected level at a specified rate.

Connection	Description
Input En	<p>A change in the status from 0 to 1 at input EN (Enable) applies the start/stop level (Offset "B" + StSp) to the output for 100 ms and starts the ramp operation to the selected level.</p> <p>A change in the status from 1 to 0 immediately sets the current level to Offset "B", which makes output AQ equal to 0.</p>
Input Sel	<p>SeI = 0: The step 1 (level 1) is selected.</p> <p>SeI = 1: The step 2 (level 2) is selected.</p> <p>A change in status of Sel causes the current level to start changing to the selected level at the specified rate.</p>
Input St	<p>A change in the status from 0 to 1 at input St (Decelerated Stop) causes the current level to decrease at a constant rate until the start/stop level (Offset "B" + StSp) is reached. The start/stop level is maintained for 100 ms and then the current level is set to Offset "B", which makes output AQ equal to 0.</p>
parameter	<p>Level1 and Level2: Levels to be reached; value range for each level: -10,000 to +20,000</p> <p>MaxL: Maximum value that must not be exceeded. Value range: -10,000 to +20,000</p> <p>StSp: Start/Stop offset: value that is added to Offset "B" to create the start/stop level. If the Start/Stop offset is 0, then the start/stop level is Offset "B". Value range: 0 to +20,000</p> <p>Rate: Speed with which level 1, level 2 or Offset is reached. Steps/seconds are issued. Value range: 1 to 10,000</p> <p>A: Gain Value range: 0 to 10,00</p> <p>B: Offset Value range: +- 10.000</p> <p>p: Number of decimal places Value range: 0, 1, 2, 3</p>

Output AQ	<p>The output AQ is scaled using the formula: $(\text{Current Level} - \text{Offset "B"}) / \text{Gain "A"}$</p> <p>Note: When AQ is displayed in parameter mode or message mode, it is displayed as an un-scaled value (engineering units: current level). Value range for AQ: 0...+32767</p>
------------------	---

Parameter p (number of decimal places)

The level parameters Level1 and Level2 can be provided by the value of another already-programmed function:

- Analog comparator: Ax - Ay
- Analog trigger: Ax
- Analog amplifier: Ax
- Analog multiplexer: AQ
- Analog ramp: AQ
- Analog math: AQ
- PI controller: AQ
- Data latching relay: AQ
- Up/Down counter: Cnt

Parameter p only applies for displaying the values of AQ, level 1, level 2, MaxL, StSp, and Rate in a message text.

Timing diagram for AQ

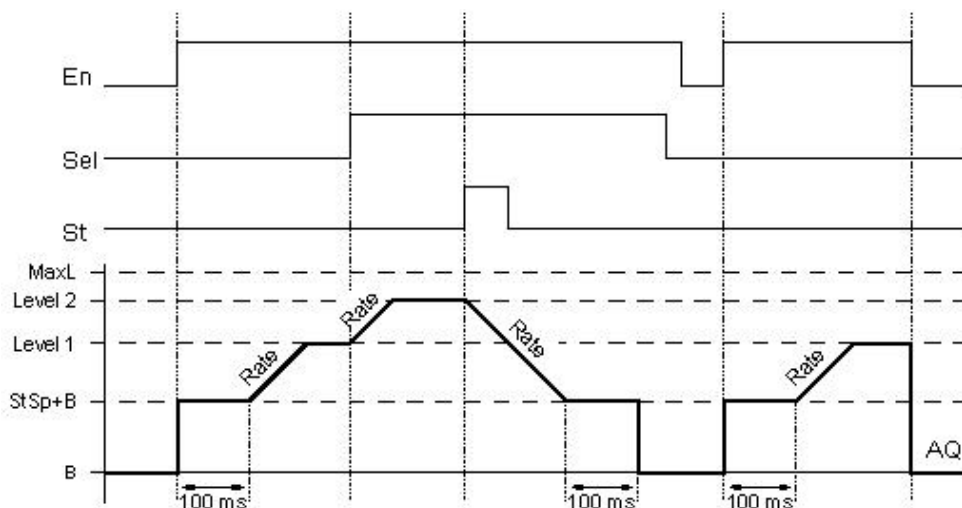

Description of function

If the input En is set, then the function sets the value StSp + Offset "B" for 100 ms. Then, depending on the connection of Sel, the function runs from the level StSp + Offset "B" to either

level 1 or level 2 at the acceleration set in Rate.

If the input St is set, the function runs to a level of StSp + B at the acceleration set in Rate. Then the function holds the level at StSp + Offset "B" for 100 ms. After 100 ms, the level is set to Offset "B". output AQ. The scaled value (output AQ) is 0.

If the input St is set, the function can only be restarted once the inputs St and En have been reset.

If input Sel has been changed, depending on the connection of Sel, the function runs from the current target level to the new target level at the rate that is specified.

If the input En is reset, the function immediately sets the current level to Offset "B".

The current level is updated every 100 ms. Note the relationship between output AQ and the current level:

$$\text{Output AQ} = (\text{current level} - \text{Offset "B"}) / \text{Gain "A"}$$

5.5.30 Analog Math

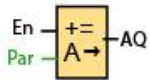

Short Description

The analog math block calculates the value AQ of an equation formed from the user-defined operands and operators.

Connection	Description
Input EN	Enable the analog math function block.
Parameter	<p>V1:Value 1: First operand V2: Value 2: Second operand V3: Value 3: Third operand V4: Value 4: Forth operand</p> <p>Operator 1: First operator Operator2: Second operator Operator 3: Third operator</p> <p>Priority 1: Priority of first operation Priority 2: Priority of second operation Priority 3: Priority of third operation</p> <p>P: number of decimals Range of values: 0,1,2,3</p>
Output AQ	The output AQ is the result of the equation formed from the operand values and operators. AQ will be set to 32767 if a divide by 0 or overflow occurs, and -32768 if a negative overflow (underflow) occurs.

Parameter p (number of decimals)

The values V1, V2, V3, and V4 can be provided by the actual value of another already-programmed function:

Analog comparator:	Ax – Ay
Analog trigger:	Ax
Analog amplifier:	Ax
Analog multiplexer:	AQ
Analog ramp:	AQ
Analog math:	AQ
PI controller:	AQ
Data latching relay:	AQ
Up/Down counter:	Cnt

Parameter p applies to the display of V1, V2, V3, V4 and AQ in a message text.

Description of the function

The analog math function combines the four operands and three operators to form an equation. The operator can be any one of the four standard operators: +, -, *, or /. For each operator, you must set a unique priority of High ("H"), Medium ("M"), or Low ("L"). The high operation will be performed first, followed by the medium operation, and then by the low operation. You must have exactly one operation of each priority. The operand values can reference another previously-defined function to provide the value. The analog math function rounds the result to the nearest integer value.

The number of operand values is fixed at four and the number of operators is fixed at 3. If you need to use fewer operands, use constructions such as " + 0" or " * 1" to fill the remaining parameters.

You can also configure the behavior of the function when the Enable parameter "En"=0. The function block can either retain its last value or be set to 0.

Possible errors: Zero division and overflow

If the analog math function block execution results in zero division or overflow, it sets internal bits that indicate the type of error that occurred. You can program an analog math error detection function block in your circuit program to detect these errors, and to control the program behavior as needed. You program one analog math error detection function block to reference one specific analog math function block.

Examples

The following tables show some simple example analog math block parameters, and the resulting equations and output values:

V1	Operator1	V2	Operator2	V3	Operator3	V4
12	+(M)	6	/ (H)	3	-(L)	1

Equation: (12 + (6 / 3)) - 1

Result: 13

V1	Operator1	V2	Operator2	V3	Operator3	V4
----	-----------	----	-----------	----	-----------	----

2	+(L)	3	*(M)	1	+(H)	4
---	------	---	------	---	------	---

Equation: $2 + (3 * (1 + 4))$

Result: 17

V1	Operator1	V2	Operator2	V3	Operator3	V4
100	-(H)	25	/(L)	2	+(M)	1

Equation: $(100 - 25) / (2 + 1)$

Result: 25

5.5.31 Analog math error detection

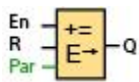

Short Description

The analog math error detection block sets an output if an error has occurred in the referenced analog math function block.

Connection	Description
Input EN	Enable the analog math error detection function block.
Input R	Reset the output
Parameter	<p>Referenced FB: block number of an analog math instruction</p> <p>Error to detect: Zero division, Overflow, or Zero division OR Overflow.</p> <p>Auto Reset: Reset the output when the failure condition clears.</p>
Output AQ	Q is set high if the error to detect occurred in the last execution of the referenced analog math function block.

Parameter Referenced FB

The value for the Referenced FB parameter references the block number of an already-programmed analog math function block.

Description of the function

The analog math error detection block sets the output when the referenced analog math function block has an error. You can program the function to set the output on a zero division error, an overflow error, or when either type of error occurs.

If you select the automatically reset check box, the output is reset prior to the next execution of the function block. If not, the output retains its state until the analog math error detection block is reset with the R parameter.

In any scan cycle, if the referenced analog math function block executes before the analog math error detection function block, the error is detected in the same scan cycle. If the referenced analog math function block executes after the analog math error detection function block, the error is detected in the

next scan cycle.

Analog math error detection logic table

In the table below, Error to Detect represents the parameter of the analog math error detection instruction that selects which type of error to detect. Zero represents the zero division bit set by the analog math instruction at the end of its execution: 1 if the error occurred, 0 if not. OF represents the overflow bit set by the analog math instruction: 1 if the error occurred, 0 if not. Zero division OR Overflow represents the logical OR of the zero division bit and the overflow bit of the referenced analog math instruction. Output (Q) represents the output of the analog math error detection function. An "x" indicates that the bit can be either 0 or 1 with no influence on the output.

Error to Detect	zero	of	Output
Zero division	1	X	1
Zero division	0	X	0
Overflow	X	1	1
Overflow	X	0	0
Zero division OR Overflow	1	0	1
Zero division OR Overflow	0	1	1
Zero division OR Overflow	1	1	1
Zero division OR Overflow	0	0	0

If the Referenced Analog Math FB is null, then the output is always 0.

5.5.32 Modbus Read

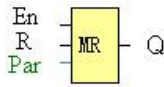

Short description:

When there is a high level at En, the Modbus Read block will be activated and the FLC shall communicate with a peripheral device as a master via RS232 or RS485 interface. Furthermore, the output will be switched on when communication is established successfully. Otherwise the output (Q pin) remains "off" which means communication has failed.

A signal at input R resets output Q and disables this block at the same time

Connection	Description
Input En	A high signal at En input will enable "Modbus Read" function block to be activated
Input R	To disable the MODBUS read function and set the output to 0 via the R (Reset) input. Reset has priority over En
Parameter	<p>Slave address: 1 is default .</p> <p>Communication protocol: Modbus(RTU)</p> <p>Communication parameter: baud rate (BPS),Data bits, Stop bits, Parity, Overtime (response time out)</p> <p>Comm Type: RS232 or RS485 (Communication interface of FLC (FLogic))</p> <p>Data register Index: High Low /Low High</p> <p>Command: 01 Read coils(0x) 02 Read Discrete Input(1x) 03 Read Holding Registers(4x) 04 Read Input Registers(3x)</p> <p>Register start address, count</p>
Output Q	Q is set or reset depending on the communication status. Successful communication , Q=1; Failed communication ,Q=0;

Note: 1. Data register Index: High Low /Low High

For example, when High Low index was set, one data 0x 00 12 was read and saved to AQ, AQ= 0X0012; however, when Low High index was set, AQ=0x 1200

Regarding Modbus RTU detail, please refer to our Modbus RTU communication protocol file for it.

Description of the function:

In the configuration of our communication, the FLC usually serves as a slave via Modbus RTU Protocol, and can communicate with a master directly. That's to say, any device communicating with FLC sends command to it, and then its response will be sent out only when the FLC has received the command, just as the below figure shows:

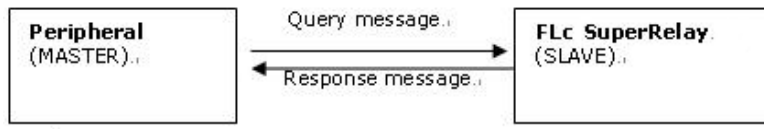

However, the “Modbus Read” or “Modbus Write”(next chapter will introduce it) function block would be utilized if FLC shall be required to play a role of master to communicate with other devices. As the following figure shows:

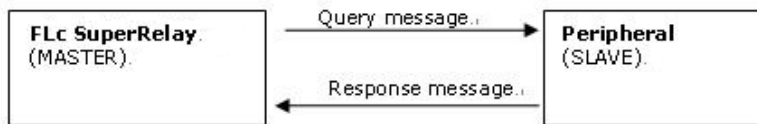

When you put the “Modbus read” or “Modbus Write” function block in your program and make some configurations, the function that FLC serves as master will be realized.

The Property in dialog box of “Modbus Read” shows as below figure:

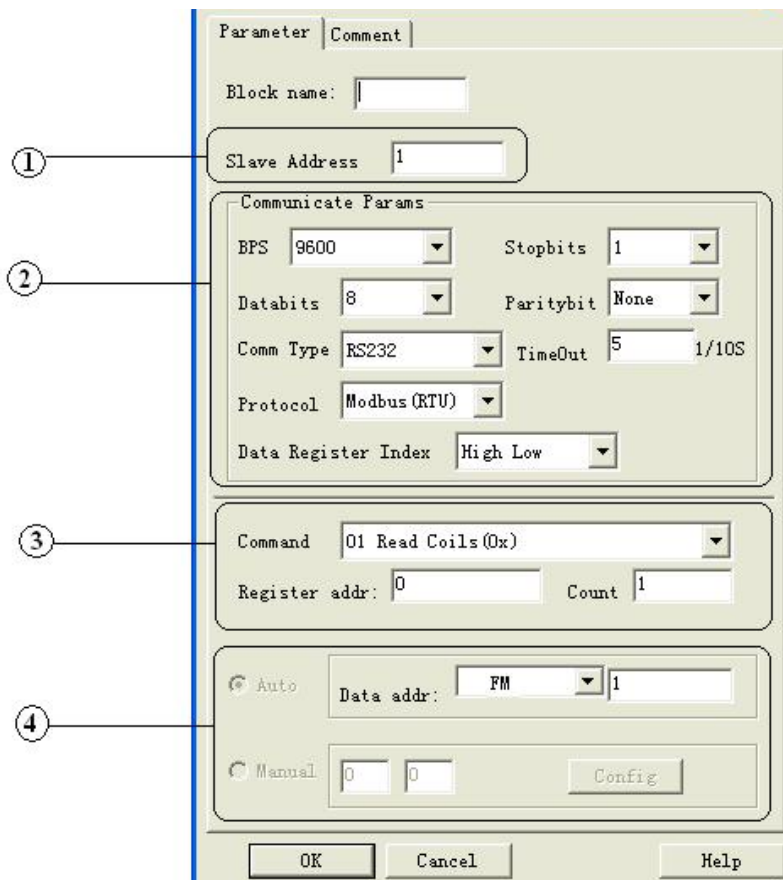

1. Slave Address: 1 is default
2. Communication parameters: BPS is baud rate, Stopbits, Databits, Communication type: RS232, RS485. Actually RS232 or RS485 are just interface of FLC.
3. Command, register address and register count.

Command	Function description	Remark
01	Read one group coil status (00000~0XXXX)	Read Coil Status (output)
02	Fetch one group data of the status of switch input (10000~1XXXX)	Read input Status (input relay)
03	Read data of multi-holding register (40000~4XXXX)	Read Holding Registers (Output register)
04	Read data of input registers (3000~3XXXX)	Read Input Registers

Note: Please use "03" command to read AI/AO of FLC

4. Where to save the data read from Slave.

Example: The following we'll take a example that one FLC (Master) communicate with other FLC (Slave) via RS485.

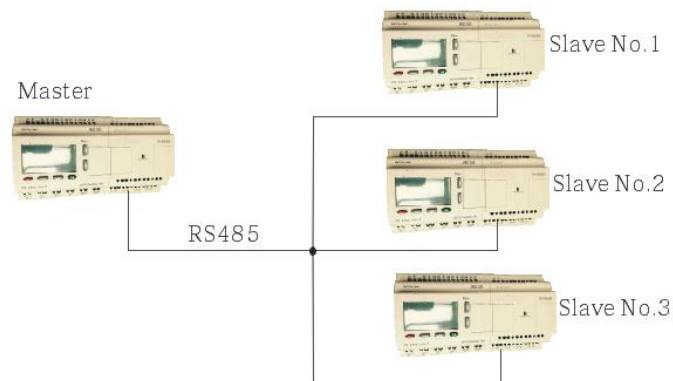

Example 1: Get Q1 status of SLAVE1 (FLC) and then save the bit status to F1.

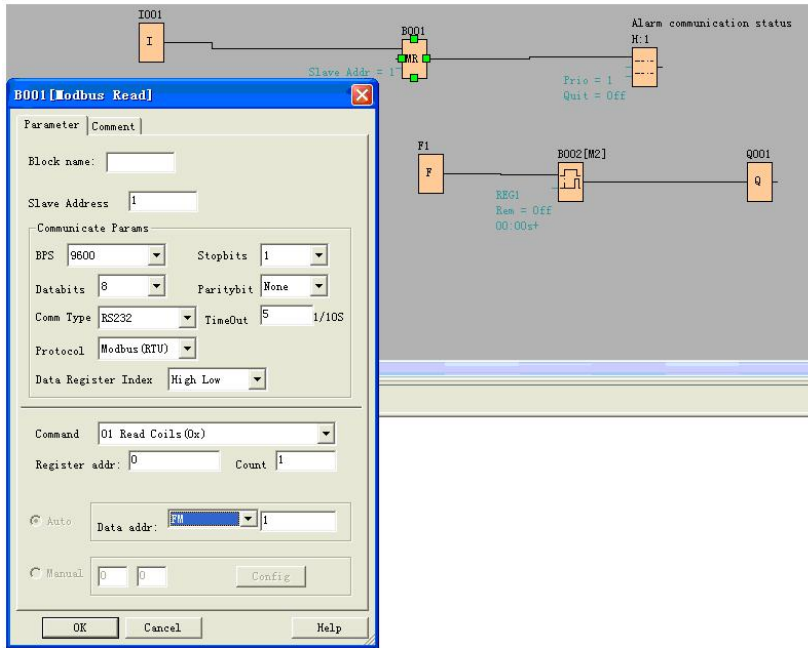

If count was set 4, the Q1, Q2, Q3, Q4 of FLC (station No.1) will be read and save to F1 to F4.

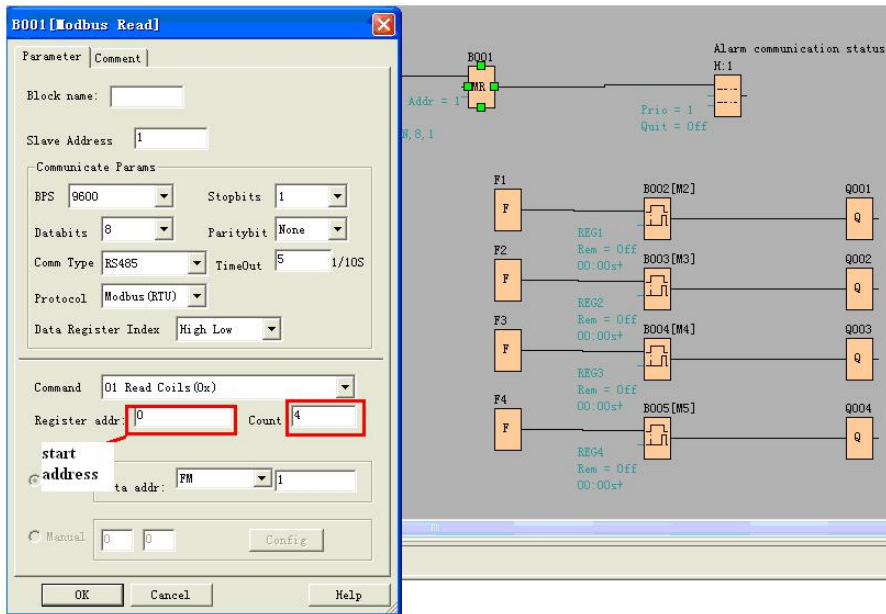

F is bit type flag. It can be used to receive bit data from slave device.

Example 2 : Get AI value from Slave 2 (FLC with station No.2) and save the data to AQ11.

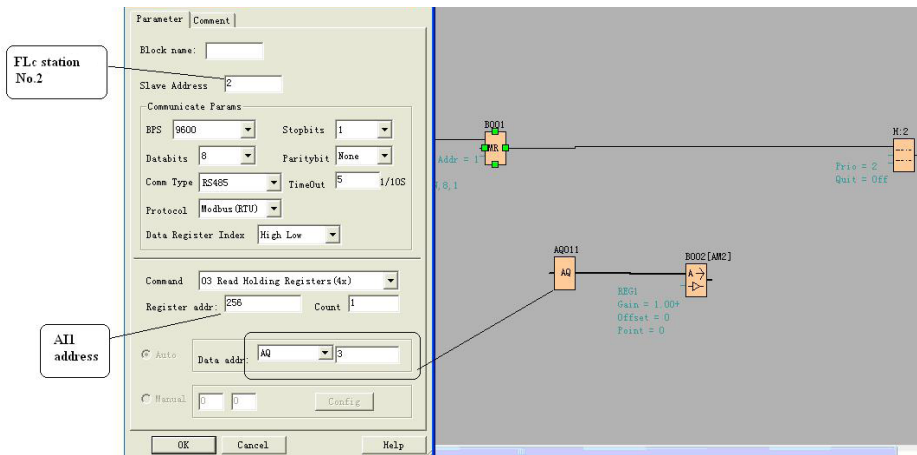

Note:

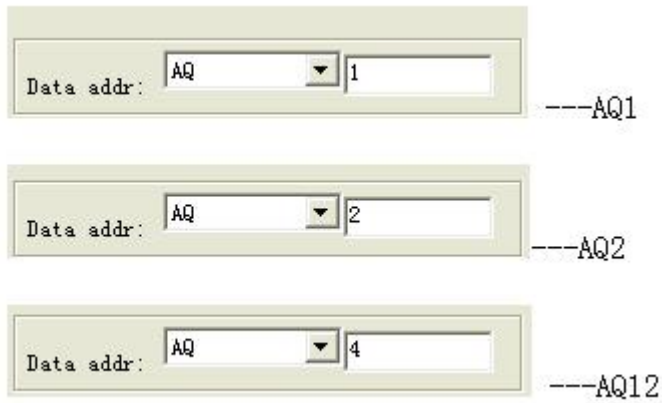

The number setting of Q, I, AQ are continuous. AQ12 cannot be set as AQ12 and should be set AQ4 as above figure shows.

The following table shows how to set.

Note: this table also can be applied for the configuration of Modbus Write function block.

Model	I,Q,AI,AQ	Dialog box set
CPU	I1-I8	I1-I8
	Q1-Q4	Q1-Q4
	AI1-AI8	AI1-AI8
	AQ1-AQ2	AQ1-AQ2
Expansion1 (Address is 1)	I11-I14	I9-I12
	Q11-Q14	Q9-Q12
	AI11-AI14	AI9-AI12
	AQ11-AQ12	AQ3,AQ4
Expansion2 (Address is 2)	I21-I24	I18-I21
	Q21-Q24	Q17-Q19
	AI21-AI24	AI17---AI24
	AQ21-AQ22	AQ5--AQ6

.....

Data format instruction

Name	Data format
F, I, Q	BIT
AF, AI, AQ,	Signed Short

5.5.33 Modbus Write

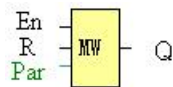

Short description:

When a high level in En, the Modbus Write block will be activated and the FLC could cote with peripheral as a master via RS232 or RS485 interface, further the output will be switched on when the communication is established successfully. Otherwise the output (Q pin) is kept "off" it means communication has failed.

A signal at input R resets output Q and disable, this block at the same time.

Connection	Description
Input En	A high signal at En input will enable "Modbus Write" function block to be activated
Input R	Reset the value read from peripheral and set the output to 0 via the R (Reset) input. Reset has priority over En
Parameter	<p>Slave address: 1 is default.</p> <p>Communication protocol: Modbus (RTU)</p> <p>Communication parameter: baud rate (BPS), Data bits, Stop bits, Parity, Overtime (response time out)</p> <p>Comm Type: RS232 or RS485 (Communication interface of FLC)</p> <p>Data register Index: High Low /Low High</p> <p>Command: 05 Write Single Coil 06 Write Single Register 15 Write Multiple Coils 16 Write Multiple Registers</p> <p>Register start address, count</p>
Output Q	Q is set or reset depending on the communication status. Successful communication, Q=1; Failed communication, Q=0;

The Property in dialog box of “Modbus Write” shows as below figure:

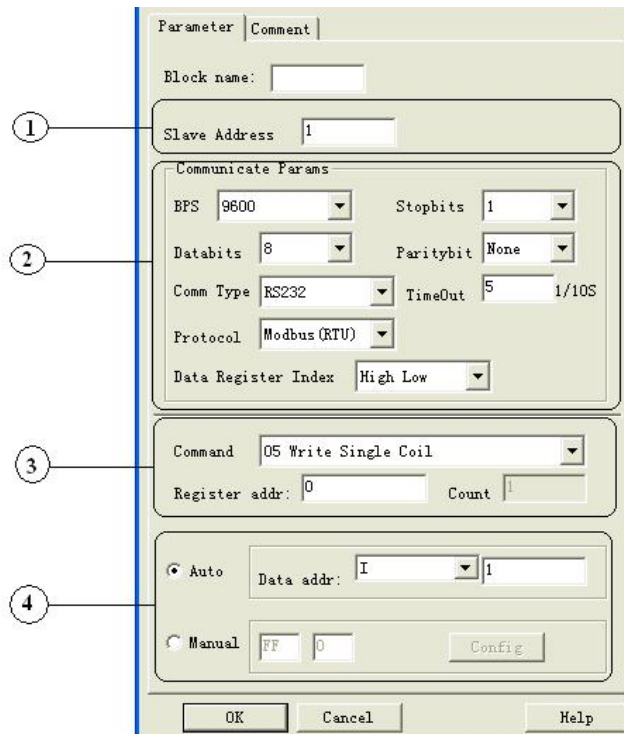

1. Slave Address: 1 is default
2. Communication parameters: BPS is baud rate. Stopbits. Databits. Communication type: RS232. RS485. Actually RS232 or RS485 are just interface of FLC.
3. Command, register address and register count.

Command	Function description	Remark
05	Force the switch status of single coil (00000~0XXXX)	Force Single Coil (output)
06	Pre-set the data of single register (40000~4XXXX)	Set single output register
15	Force multi-coils on/off bit (00000~0XXXX)	
16	Write multi-holding registers data (40000~4XXXX)	

4. Where is to save the pre-configuration data that would be written to Slave. It contains 2 kind ways to pre-configuration. One is auto mode, this data uses the flags in the program, such as FM, AFM, I, Q and AQ. The manual mode is input a fixed value or bit status.

Example 1

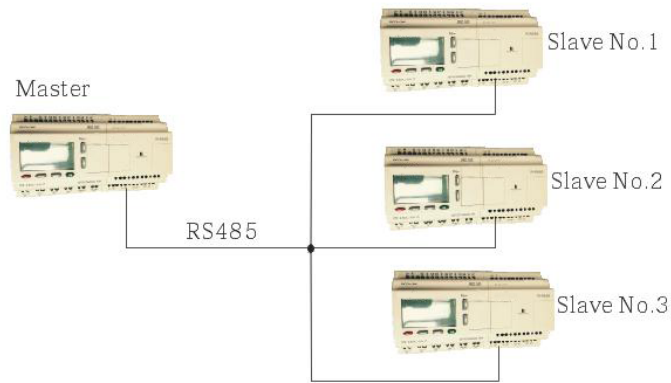

Write the I2 bit status of Master FLC to Slave FLC with No.1 and control Q1 of Slave via RS485 port.
The program of master can be made as follows:

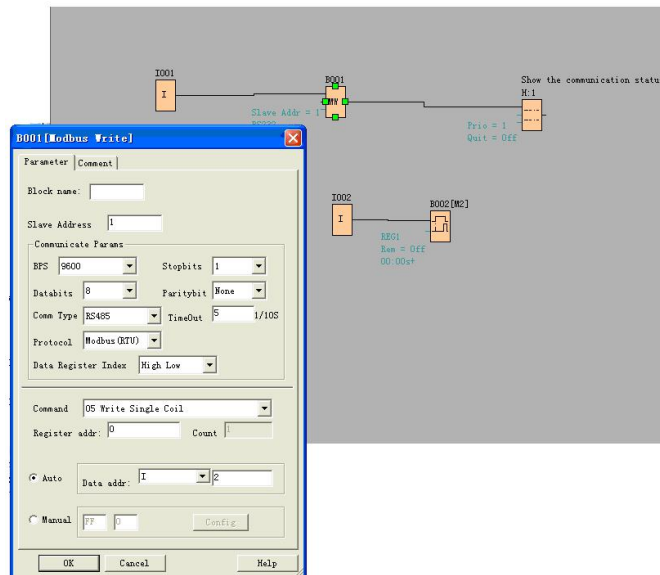

I1 of master is used to control the communication. If I1 is high and the communication is established successfully, one alarm message (text message block) will be displayed on LCD. Then the Q1 of slave No.1 will be controlled by I2 of master. If I2 is high, Q1 of slave No.1 would be ON and if I2 is low, Q1 of slave would be OFF.

Note: The Q1 must be free, it means the in the program of Slave No.1, the input pin of Q1 must be not linked to other blocks.

Example 2, manual mode input value

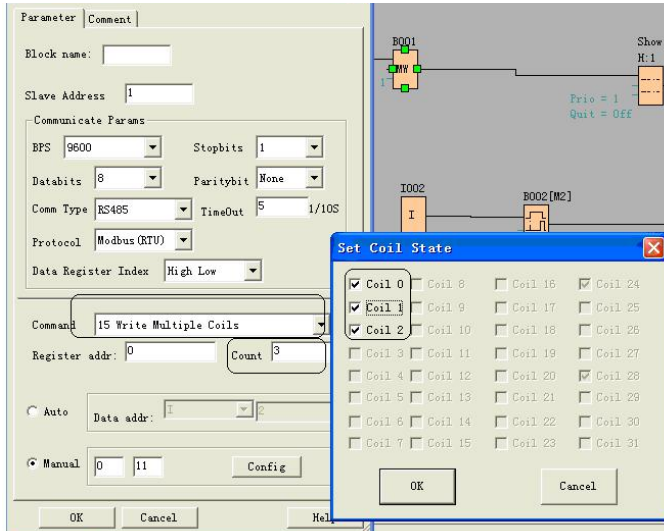

The above configuration is to force Q1, Q2, Q3 of Slave No.1 ON. " Coil 0" means pre-set the BIT 1 and " Coil 0" means pre-set the BIT 0 "Coil 0" is corresponding to the start address, Here is Q1.

Note: The manual input value is Hex data .it contains 4 bytes. If you want to write a decimal value to the register of SLAVE, please convert it to Hex format.

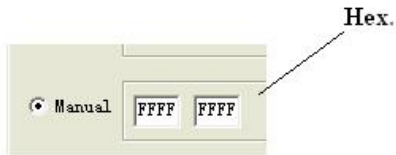

4. The following table shows how to set.

Note: this table also can be applied for the configuration of Modbus Read function block

MODEL	I, Q, AI, AQ	DIALOG BOX SET
CPU	I1-I12	I1-I12
	Q1-Q6	Q1-Q6
	AI1-AI8	AI1-AI8
	AQ1-AQ2	AQ1-AQ2
Expansion 1 (Address is 1)	I11-I18	I13-I20
	Q11-Q18	Q7-Q14
	AI11-AI18(AI15-AI18 are reserved)	AI9-AI12
	AQ11-AQ12	AQ3-AQ4
Expansion 2 (Address is 2)	I21-I28	I21-I28
	Q21-Q28	Q15-Q22
	AI21-AI28	AI17-AI24
	AQ21-AQ22	AQ5-AQ6

Data format instruction

Name	Data format
F, I, Q	BIT
AF, AI, AQ,	Signed Short

For the detail information about I, AI, Q, AQ, registers address of FLC, refer to the RTU protocol file.

5.5.34 Data latching relay

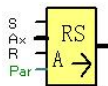

Short description

This special function saves the process variable of an analog input to memory, and returns it at the analog output.

Connection	Description
Input S	Save the Ax to memory and return it at the analog output with a signal at input S (Set).
Input Ax	Input the analog signal to be amplified at input Ax. Use the analog inputs, the block number of a function with analog output, or the analog outputs.
Input R	Reset analog output AQ to 0 with a signal at input R (Reset). analog Output AQ is reset if S and R are both set (reset has priority over set).
Output AQ	Analog output Value range for AQ: -32768...+32767
Parameter	Value range for Start value: -32768...+32767

Example

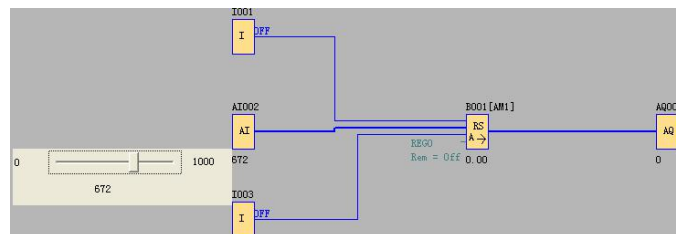

When I1 turn to HIGH, the value of AI2 will be saved to memory and return it to AQ1 as follows:

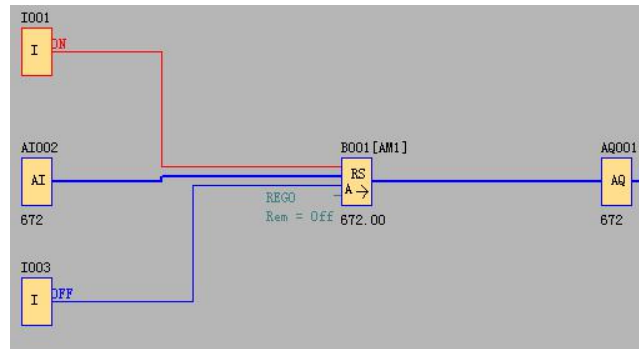

When the I3 turns to HIGH, the value of this function block will be reset to 0.

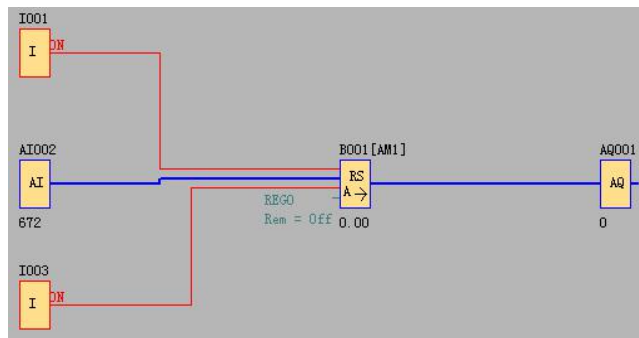

1. Start value, you can set a start value for the data latch relay block now.



2. The HEG value of the data latch relay can be modified by press OK key for 3 seconds in text message block.

The HEG value of data latch relay block also can be displayed with decimal point now.

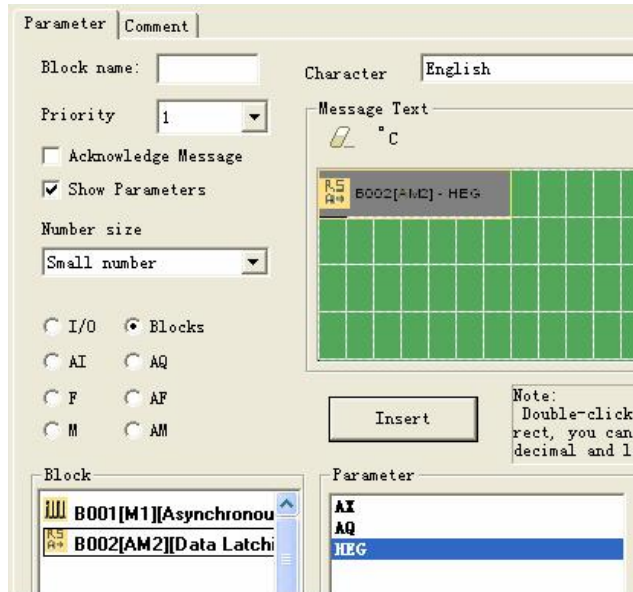

There is Modbus address for the HEG, so you can also can change the HEG value by Master (Touch screen etc.). You can found the address in the modbus RTU protocol (Memory map) file.

Note: If your firmware of CPU cannot support such function, you can download the firmware update package from our website.

5.5.35 PI controller

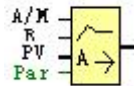

Short Description

It is proportional-action and integral-action controllers. You can use both types of controller individually or combined.

Connection	Description
Input A/M	Set the mode of the controller: 1: automatic mode 0: manual mode
Input R	Use the input R to reset the output AQ. As long as this input is set, the input A/M is disabled. The output AQ is set to 0.
Input PV	Analog value: process value, Influences the Output
Parameter	Sensor: Type of sensor being used Min.: Minimum value for PV value range: -10,000 to +20,000 Max.: Maximum value for PV value range: -10,000 to +20,000

	<p>A: Gain Value range: +- 10.00</p> <p>B: Offset Value range: +- 10,000</p> <p>SP: Set-value assignment value range: -10,000 to +20,000</p> <p>Mq: Value from AQ with manual mode. Value range: 0 to 1,000</p> <p>Parameter sets: application-related presets for KC, TI and Dir (see below)</p> <p>KC: Gain value range: 00.00 to 99.99</p> <p>TI: Integral time value range 00:01 min to 99:59 min</p> <p>Dir: Action direction of the controller value range: + or -</p> <p>p: Number of decimal places value range: 0, 1, 2, 3</p>
Output AQ	<p>Analog output (manipulated variable) Value range for AQ: 0 to 1,000</p>

Parameter P (number of decimal places)

Only applies for portraying the values from PV, SP, Min. and Max. in a message text.

Timing Diagram

The nature, manner and speed with which the AQ changes depends on the parameters KC and TI. Thus, the course of AQ in the diagram is merely an example. A control action is continuous; therefore the diagram portrays just an extract.

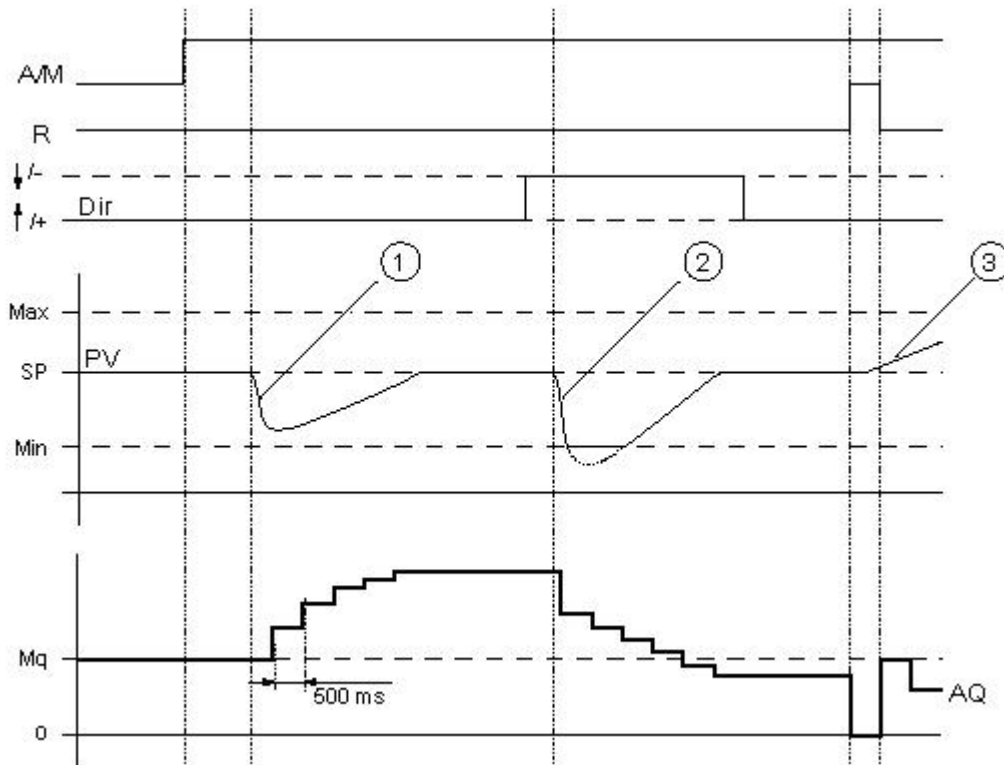

1.	A disturbance causes the PV to drop, as Dir is positioned upwards, AQ increases until PV corresponds again to SP.
2.	A disturbance causes the PV to drop, as Dir is positioned upwards, AQ decreases until PV corresponds again to SP. Dir is coordinated to the basic conduct of a control loop. The direction (dir) cannot be changed during the term of the function. The change in Dir here is shown for the purposes of clarification.
3.	As AQ is set to 0 by means of the input R, PV changes. This is based on the fact that PV increases, which on account of Dir = upwards causes AQ to drop.

Description of Function

If the input A/M is set to 0, then the special function issues output AQ with the value that you set with parameter Mq.

If the input A/M is set to 1, then automatic mode commences. As an integral sum the value Mq is adopted, the controller function begins the calculations in accordance with the formulas given in Control and regulate basics. The updated value PV is used to calculate in the formulas.

$$\text{Updated value PV} = (\text{PV} * \text{gain}) + \text{offset}$$

If the updated value PV = SP, then the special function does not change the value of AQ.

Dir = upwards/+ (timing diagram numbers 1 and 3)

- If the updated value $PV > SP$, then the special function reduces the value of AQ.
- If the updated value $PV < SP$, then the special function increases the value of AQ.

Dir = downwards/- (timing diagram number 2)

- If the updated value $PV > SP$, then the special function increases the value of AQ.
- If the updated value $PV < SP$, then the special function reduces the value of AQ.

With a disturbance, AQ continues to increase / decrease until the updated value PV again corresponds to SP. The speed with which AQ changes depends on the parameters KC and TI. If the input PV exceeds the parameter Max., then the updated value PV is set to the value of Max.. If the PV falls short of the parameter Min., then the updated value PV is set to the value of Min.

If the input R is set to 1, then the AQ output is reset. As long as R is set, the input A/M is disabled.

Sampling Time

The sampling time is fixed at 500 ms.

Parameter sets

In order to simplify the use of the PI controller, the parameters for KC, TI and Dir are already given as sets for the following applications:

Parameter set	Application example	Parameter KC	Parameter TI (s)	Parameter Dir
Temperature fast	Temperature, cooling control of small spaces; small volumes	0,5	30	+
Temperature slow	Heating, ventilation, temperature, cooling control of large spaces; large volumes	1,0	120	+
Pressure 1	Quick pressure change, compressor control	3,0	5	+
Pressure 2	Slow pressure change, differential pressure control (flow controller)	1,2	12	+
Full level 1	Vat and/or reservoir filling without drain	1,0	1	+
Full level 2	Vat and/or reservoir filling with drain	0,7	20	+

Characteristics when configuring

Observe the Control and regulate basics.

Control and regulate

In engineering, quantities can be both controlled and regulated.

When controlling, a quantity is manipulated without being able to compensate for outside influences.

When regulating, a quantity is maintained at a specific value in order to compensate for outside influences.

In the following example, controlling means that the person can set the heat output at a fixed value. The heater cannot compensate for the drop in room temperature when a window is opened.

In the example below, regulating means that the person can increase the heat output if the room temperature drops to below 20°C. If the room temperature rises above 20°C, the heat output is reduced.

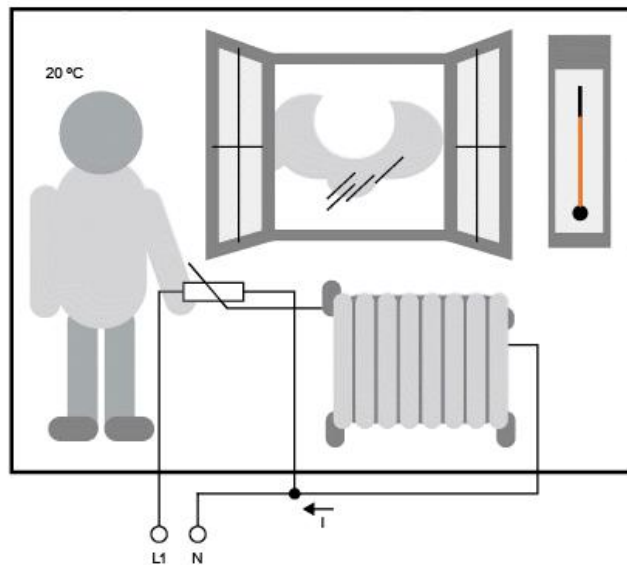

Basic concepts of regulating

In the example, the current for the electric heating is the manipulated variable. The changeable resistance is the actuator. The hand that operates the actuator is the control. The actual room temperature is the controlled variable or the process value. The desired room temperature is the command variable or the setpoint value. The electric heating is the control process. The thermometer is the sensor. The temperature loss from opening the window is the disturbance variable.

So this means that the person measures the process value (room temperature) with the sensor (thermometer), compares the process value (room temperature) with the command variable (desired room temperature) and uses the actuator (changeable resistance) to manually regulate the manipulated variable (heating current), in order to compensate for the disturbance variable (temperature drop from opening the window). The person is therefore the controller.

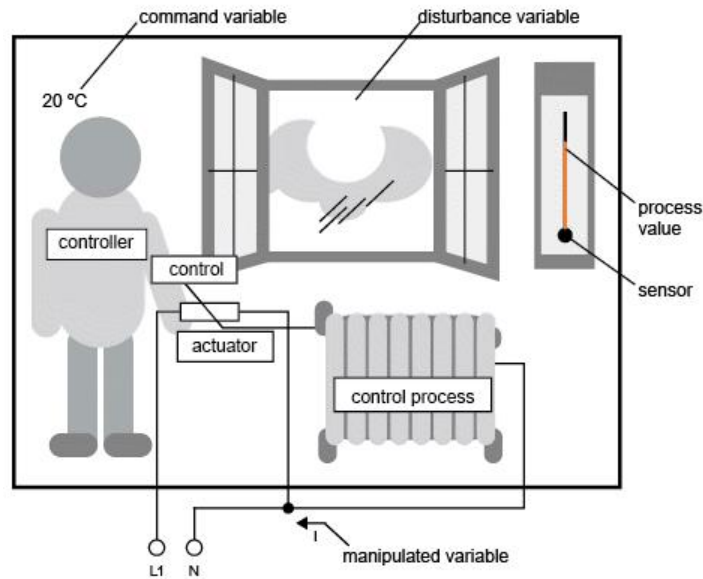

The control device is formed from the actuator and the control.

The control and controller together form the regulating device.

The following picture gives an abstract portrayal of the situation described above.

The comparing element uses the sensor to compare the command variable with the process value. If the command variables and process value deviate from one another, this results in a positive or negative loop error that in turn changes the process value.

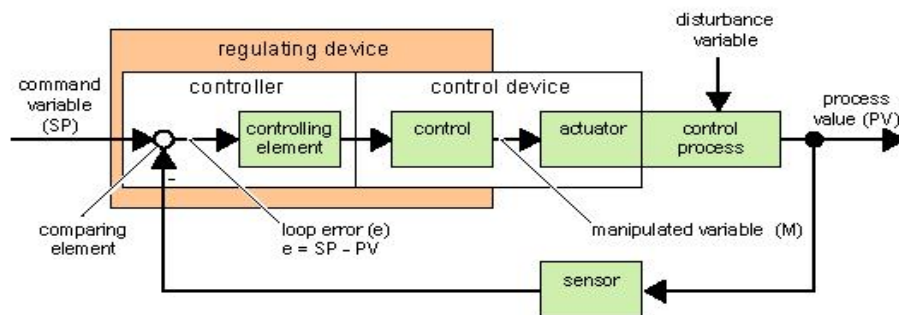

Control loop

The process value x influences the manipulated variable M by means of the regulating device. This creates a closed circuit that is also known as a control loop.

If, in the example above, the window is opened, the temperature in the room drops. The person must increase the heat output of the heater. If the heat output is increased too much, it will get too hot. The person must then reduce the heat output.

If the heat output is increased or reduced too quickly, then the control loop starts to sway. The room temperature fluctuates. It is either too hot or too cold. To prevent this, the person must carefully and slowly reduce or increase the heat output.

Loop error

The loop error is the difference between the command variable and the process value. In other words: the deviation of a process value from a set value.

$$e = SP - PV$$

The loop error e brings about a change to the manipulated variable M .

The example above illustrates this very well: if, with a desired temperature of 20°C (= command value w), the room temperature is 22°C (= process value PV), this results in the loop error:

$$e = SP - PV = 20^{\circ}\text{C} - 22^{\circ}\text{C} = -2^{\circ}\text{C}$$

In this case, the negative sign indicates a reversing action: the heat output is reduced.

In a control loop's state of equilibrium, the loop error is zero or very small. If the command variable changes or there is a disturbance, a loop error arises. The loop error is corrected by means of the manipulated variable M .

Controller basics

A controller can be simply portrayed as follows:

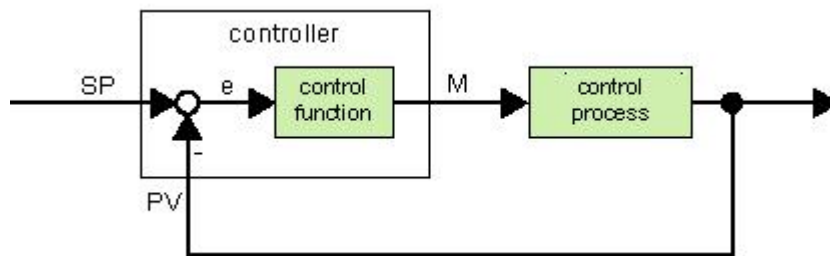

The comparing element and the controller function describe the conduct of the controller.

The following describes the most important types of controller. A controller's step response tells us a lot about its conduct. The step response describes how a controller reacts to the erratic change in the process value.

There are 3 important basic types of controller:

Proportional-action controller (P controller)

Integral-action controller (I controller)

Differential-action controller (D controller – we're not touching on this here)

These are combined for a real controller. For instance, the PI controller:

P Controller

A proportional-action controller (P controller) changes the manipulated variable M proportional to the loop error. The P controller works immediately. By itself it cannot drive the loop error to zero.

$$M_{Pn} = k_P \times e_n$$

M_{Pn} :Manipulated variable of the P controller at the time n

k_P :Gain of the P controller

e_n : Loop error at the time n

The following picture shows a jump in process value and step response of the controller:

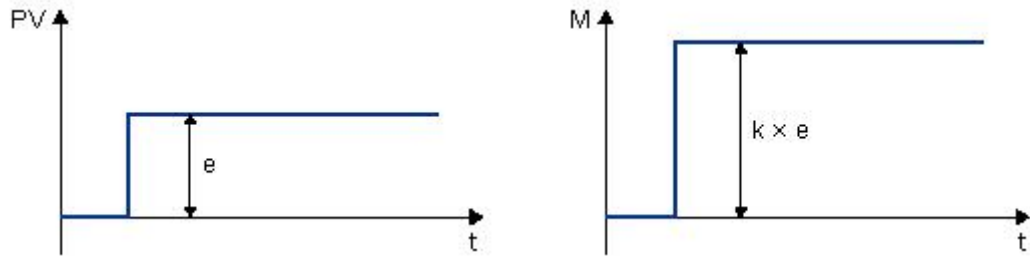

Summary

The P controller has the following characteristics:

It cannot correct faults with the control process > lasting loop error.

It reacts immediately to a change in the process value.

It is stable.

I Controller

An integral-action controller (I controller) changes the manipulated variable M proportional to the loop error and to the time. The I controller works by delayed action. It completely remedies a loop error.

In order to calculate the value of the manipulated variable at a period of time n, the time up until this period of time must be divided into small time slices. The loop errors at the end of each time slice must be added up (integrated) and they are then entered in the calculation.

$$M_{In} = k_I \times (T_S / T_I) \times (e_n + e_{n-1} + e_{n-2} + e_{n-3} + \dots + e_0) = k_I \times (T_S / T_I) \times e_n + M_{In-1}$$

M_{In} : Manipulated variable of the I controller at the time n

M_{In-1} : Manipulated variable of the I controller at the time n-1; also called integral sum

k_I : Gain of the I controller

T_S : Sampling time, duration of a time slice

T_I : Integral time: by means of this time, the influence of the integral part is controlled on the manipulated variable, also known as integral-action time

e_n : Loop error at the time n

e_{n-1} : Loop error at the time n-1; etc.

e_0 : Loop error at the beginning of the calculations

The following picture shows a jump in process value and step response of the controller:

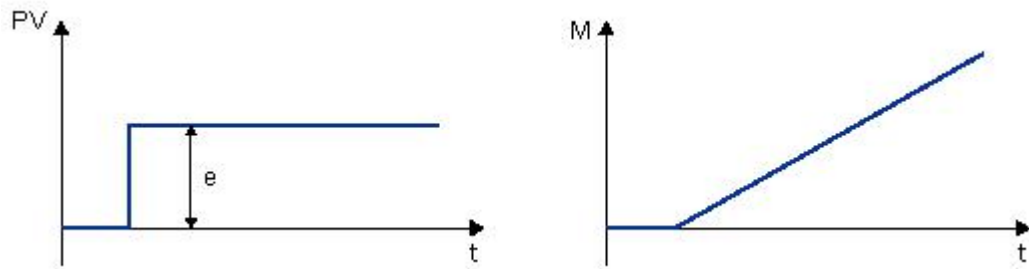

Summary

The PI controller has the following characteristics:

It sets the process value exactly to the command variable.

By so doing, it tends to oscillate and is unstable.

It requires more time to carry out the control action than the P controller.

PI controller

A PI controller reduces the loop error immediately and will eventually drive the loop error to zero.

$$M_n = M_{Pn} + M_{In} = k_P \times e_n + k_I \times (T_S / T_I) \times e_n + M_{In-1}$$

M_n : Manipulated variable at the time n

M_{Pn} : Proportional part of the manipulated variable

M_{In} : Integral part of the manipulated variable

M_{In-1} : Manipulated variable of the I controller at the time n-1; also called integral sum

k_P : Gain of the P controller

k_I : Gain of the I controller

T_S : Sampling time, duration of a time slice

T_I : Integral time; by means of this time the influence of the integral part is controlled on the manipulated variable, also known as the integral-action time

e_n : Loop error at the time n

The following picture shows a jump in process value and step response of the controller:

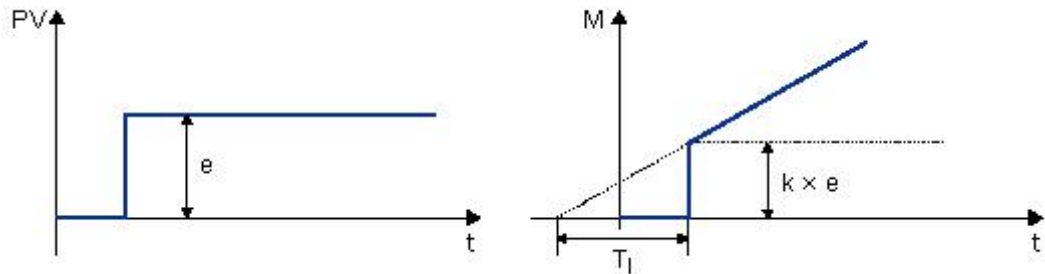

Summary

The PI controller has the following characteristics:

The P controller components quickly intercept an occurring loop error.

The I controller components can then remedy the remaining loop error.

The controller components supplement each other so that the PI controller works quickly and precisely.

Description of the individual parameters

Controller parameters	Portrayed in FLC	Possible value range in the FLC
Mn Manipulated variable at the time n	Output of the PI controller block	0 to 1,000
kP Gain of the P part	In the FLC, the parameter KC applies as an increase for the I part and the P part of the controller equally. Should you enter KC=0, then the P part of the controller switches off. In this special case, k is automatically set to 1 for the I part. If KC = 0: kP = 0 and kI = 1	0.00 to 99.99
kI Gain of the I part	If KC <> 0: kP = kI = KC	
Ts Sampling time, duration of a time slice	Fixed	500 ms
TI Integral time	Parameter TI, if you set this parameter to 99:59 min, then you switch off the I part of the controller.	00:01 min to 99.59 min

en Loop error at the time n; generally applies: $e = SP - PV$	Refer to SP and PV	"
SP	The parameter SP is the set-value assignment w. For this parameter you can use the analog output of a different special function.	-10,000 to +20,000
PV	PV is the process value x and is calculated as follows: $PV = (\text{analog value on input} * \text{gain}) + \text{offset}$. You can connect the input for example by means of an analog input with a PT100 sensor.	"
	The gain parameter has an effect on PV	0.0 to 10.0
	The offset parameter has an effect on PV	-10,000 to +20,000
	PV is restricted by the parameters Min. and Max.	In each case: -10,000 to +20,000
	The Dir parameter gives the action direction of the controller. Positive means: If set value > process value then the process value is increased; if set value < process value then the process value is reduced. Negative means: If set value > process value then the process value is reduced; if set value < process value then the process value is increased. e.g. heat regulation: if the set value is greater than the process value (room is too cold), the manipulated variable increases the process value.	- or +

5.5.38 Word to Bit

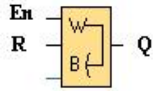

Short description

This special function is used to transfer the word type data (AI, AF or AQ) to 16 bit status (0 or 1) (F or Q)

Connection	Description
Input En	Enable this function.
Input R	Reset output Q with a signal at input R (Reset).
Parameter	Retentivity set (on) = the status is retentive in memory.
Output Q	Q is switched on with a signal at input En, and switched off with a low signal at input En.

Example1:

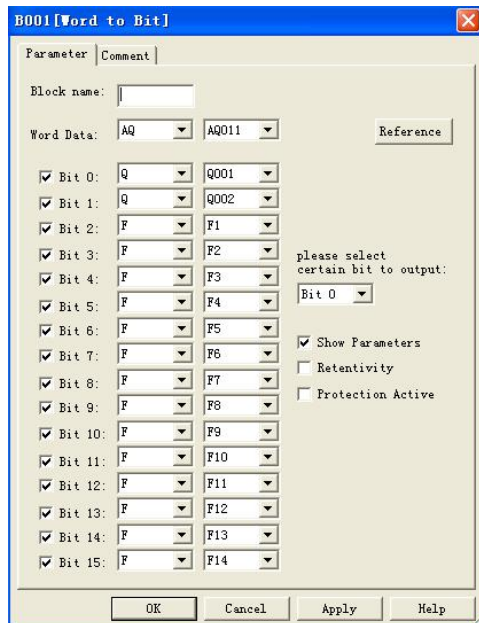
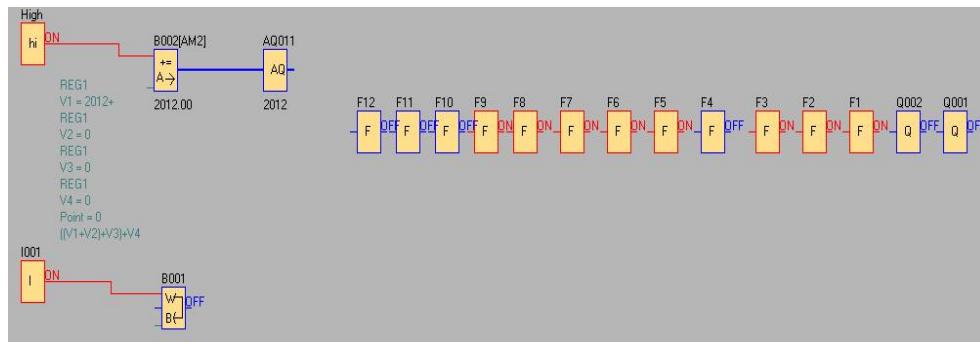

Convert the AQ11 (2012) to Q1, Q2 and F1--F14(0000011111011100)

Example2:

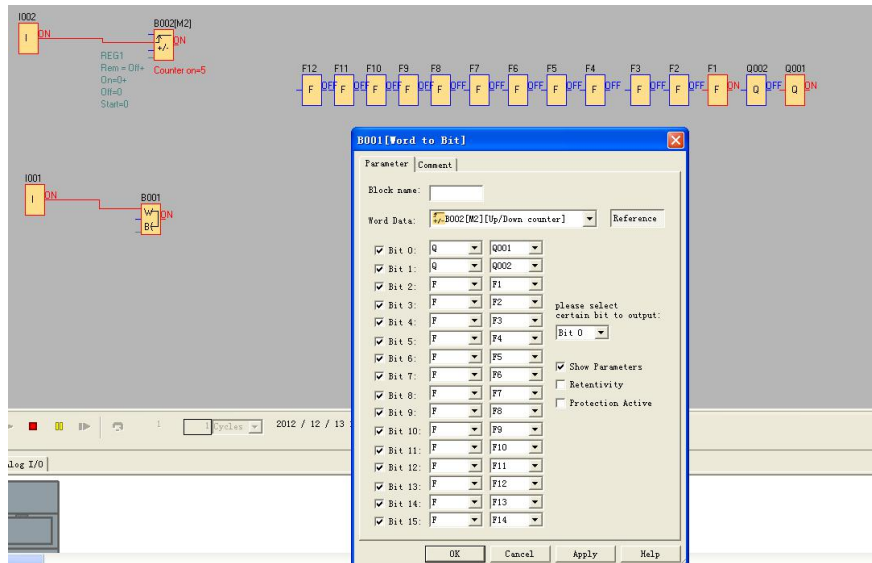

Convert the counter value (5) to Q1, Q2 and F1--F14(0000000000000101)

5.5.39 Bit to Word

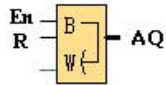

Short description

This special function is used to transfer the 16-Bit status(0 or 1)(F or Q) to word type data (AF or AQ).

Connection	Description
Input En	Enable this function.
Input R	Reset output AQ with a signal at input R (Reset).
Parameter	Retentivity set (on) = the value is retentive in memory when power lost.
Output AQ	AQ will output the value of the block when En was activated.

For example

Transfer the F1--F3 and Q1 status to the AQ001. F1 is saved in Bit0, F2 is saved in Bit1, F3 is saved in Bit2, Q1 is saved in Bit3.

F1	F2	F3	Q1	AQ1 value
0	0	0	0	0
1	0	0	0	1
0	1	0	0	2
1	1	0	0	3
0	0	1	0	4

1	0	1	0	5
0	1	1	0	6
1	1	1	0	7
0	0	0	1	8
1	0	0	1	9
0	1	0	1	10
1	1	0	1	11
0	0	1	1	12
1	0	1	1	13
0	1	1	1	14
1	1	1	1	15

Notes:

- 1.The Bit4--Bit15 was not ticked, they are all recognized as 0.
- 2.With such block you can realize to modify one bit of the word register in the slave devices together with the code 06/16 in Modbus network.

5.5.40 Stopwatch

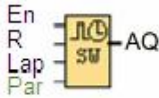

Short description

The stopwatch records the time elapsed since it was enabled.

Connection	Description
Input En	En (Enable) is the monitoring input. FLC sets the current elapsed time to 0 and begins counting elapsed time when En transitions from 0 to 1. When En transitions from 1 to 0, the elapsed time is frozen.
Input Lap	A positive edge (0 to 1 transition) at input Lap pauses the stopwatch, and sets output to lap time. A negative edge (1 to 0 transition) at input Lap resumes the stopwatch, and set the output to current elapsed time..
Input R	A signal at input R (Reset) clears the current elapsed time and lap time.
Parameter	Time base for elapsed time, which you can set to hours, minutes, seconds, or 1/100ths of seconds.
Output AQ	The output AQ outputs value of the current elapsed time when it is a negative edge (1 to 0 transition)at the input Lap, and outputs value of the Lap time when it is a positive edge (0 to 1 transition) at the input Lap. A positive edge (0 to 1 transition) resets the value at output AQ to 0.

Parameters Time base

You can configure the time base for the analog output:

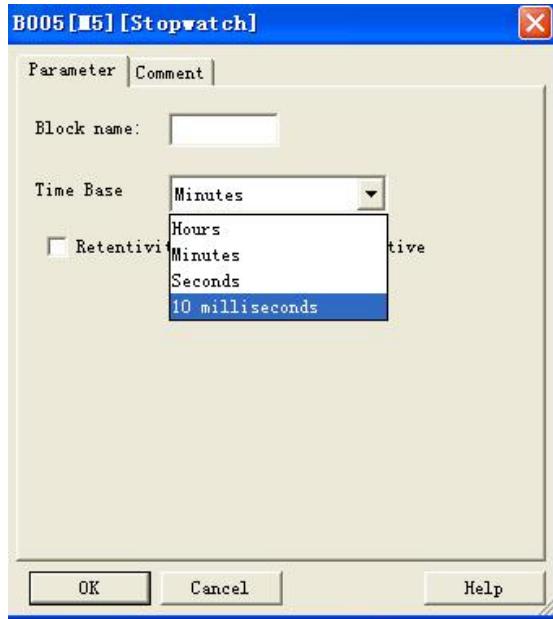

The time base for the elapsed time can be in hours, minutes, seconds, or 1/100ths of seconds (units of 10 milliseconds). The smallest time base, and therefore the resolution, is 10 milliseconds, or 1/100ths of seconds.

Timing diagram

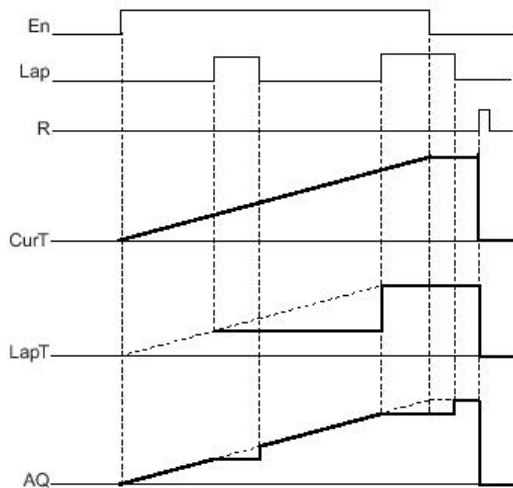

Description of the function

When En = 1, the current time increases.

When En = 0, the current time counting pauses.

When En = 1 and Lap = 0, the output AQ outputs the value of the current elapsed time.

When En = 1 and Lap = 1, the current time continue increasing, but the output AQ outputs the value of the Lap time.

When En = 0 and Lap = 1, the output AQ outputs the value of the Lap time.

When En = 0 and Lap = 0, the output AQ outputs the value of the latest current time.

When R = 1, both the current time and the Lap time are reset.

5.5.41 Analog filter

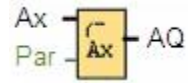

Short Description

Connection	Description
Input Ax	Analog Inputs Analog Outputs Analog Flags The block number of a function with analog output
Parameter	Sn (Number of samples): determines how many analog values are sampled within the program cycles that are determined by the set number of samples. FLC samples an analog value within every program cycle. The number of program cycles is equal to the set number of samples. Possible settings: 8, 16, 32, 64, 128, 256.
Output AQ	AQ outputs an average value of the analog input Ax over the current number of samples, and it is set or reset depending on the analog input and the number of samples. * Analog inputs: 0 to 10 V corresponds with 0 to 1000 (internal value).

Parameter

You can set the number of samples to the following values:

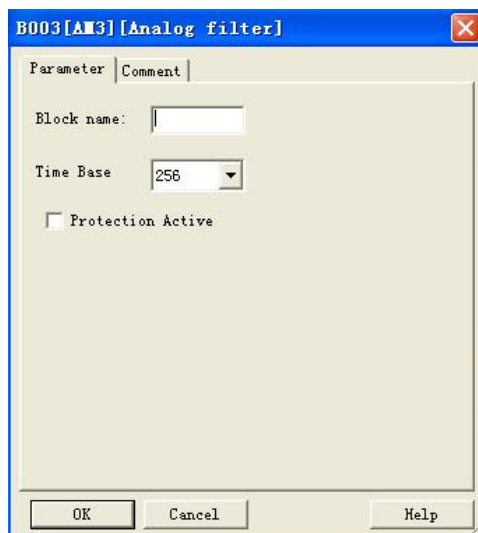

After you set the parameter, the analog filter calculates the average value of the samples and assigns this value to AQ.

Timing diagram

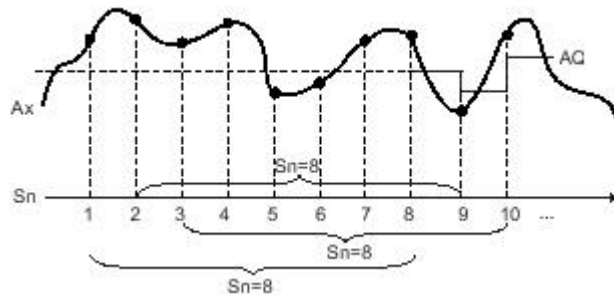

Description of function

The function outputs the average value after sampling the analog input signal according to the set number of samples. This SFB can reduce the error of analog input signal.

Note

There are a maximum of eight analog filter function blocks available for use in the circuit program in FLC Logic Soft.

5.5.42 Max/Min

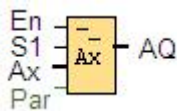

Connection	Description
Input En	The function of input En (Enable) depends on the settings of parameter Mode and the selection of check box "when En = 0, reset Max/Min".
Input S1	This input is enabled when you set Mode =2: A positive transition (0 to 1) at input S1 sets the output AQ to the maximum value.. A negative transition (1 to 0) at input S1 sets the output AQ to the minimum value.
Input Ax	Input Ax is one of the following analog signals: Analog Inputs Analog Outputs Analog flags Block number of a function with analog output
Parameter	Mode Possible settings: 0, 1, 2, 3

	<p>Mode = 0: AQ = Min</p> <p>Mode = 1: AQ = Max</p> <p>Mode = 2 and S1= 0 (low): AQ = Min</p> <p>Mode = 2 and S1= 1 (high): AQ = Max</p> <p>Mode = 3 or a block value is referenced: AQ = Ax</p>
Output AQ	<p>AQ outputs a minimum, maximum, or actual value depending on the inputs, or is reset to 0 if configured to do so when function is disabled</p> <p>Analog inputs: 0 to 10 V corresponds with 0 to 1000 (internal value).</p>

Parameter Mode

You can set the values for parameter Mode based on the actual values of another already-programmed function:

- Analog comparator: Ax - Ay
- Analog threshold trigger: Ax
- Analog amplifier: Ax
- Analog multiplexer: AQ
- Analog ramp: AQ
- Analog math: AQ
- Up/Down counter: Cnt
- Threshold trigger: Fre
- Max/Min: Ax
- PI controller: AQ
- Analog filter : AQ
- Average value : AQ

You can select the required function by the block number.

Timing diagram

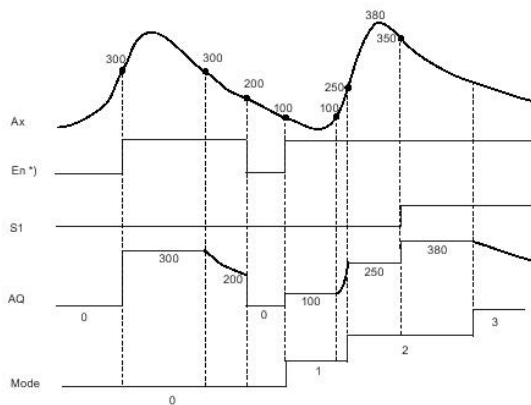

*) If you select the check box "when En = 0, reset Max/Min"

Description of the function

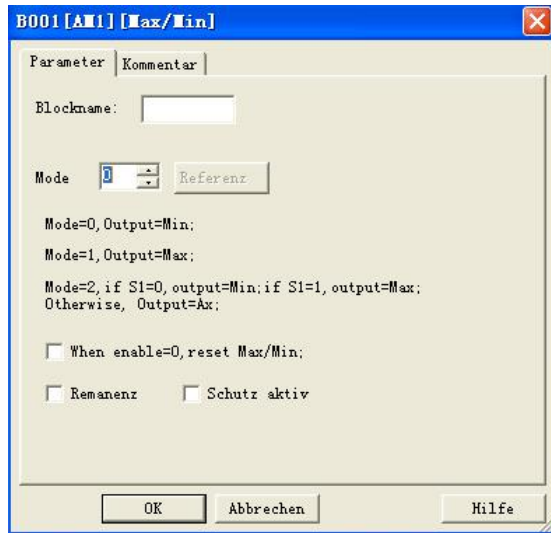

If you select the check box "when En = 0, reset Max/Min":

En = 0: The function sets the AQ value to 0.

En = 1: The function outputs a value at AQ, depending on the settings of Mode and S1.

If you do not select the check box "when En = 0, reset Max/Min":

En = 0: The function holds the value of AQ at the current value.

En = 1: The function outputs a value at AQ, depending on the settings of Mode and S1.

Mode = 0: The function sets AQ to the minimum value

Mode = 1: The function sets AQ to the maximum value

Mode = 2 and S1 = 0: The function sets AQ to the minimum value

Mode = 2 and S1 = 1: The function sets AQ to the maximum value

Mode = 3 or a block value is referenced: The function outputs actual analog input value.

Max/Min block upper/lower function

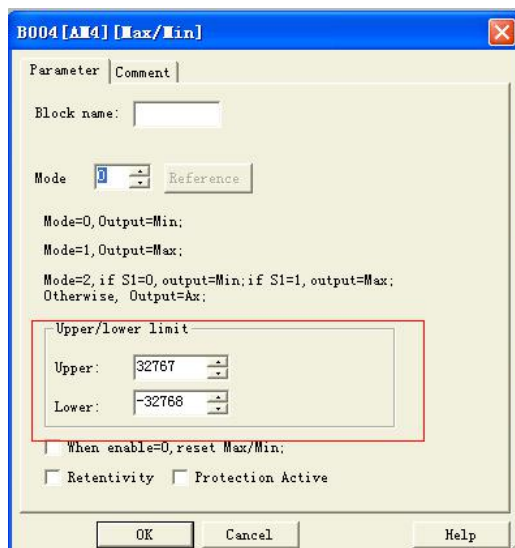

In the dialog box of Max/Min block, there is a upper/lower limit setting, when the block output the AQ value is less than the lower value, the AQ shall be equal to the Lower value; While the block output the

AQ value is more than the upper value, the AQ shall be equal to the upper value.

If someone wants to use the upper/lower limitation for other function blocks. Such upper/lower limit function can be used, then this block can be referenced as other blocks parameters when programming.

Here is an example:

Someone wants to use the panel key to change the on-delay parameters for 1s-10s in the text message block, if the value which user set exceeds such range, then it will crush the machine, hence we must add the upper/lower limitation in the program to avoid such trouble.

5.5.43 Average value

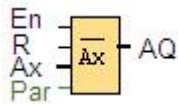

Short description

The average value function samples the analog input signal during configured time period and outputs the average value at AQ.

Connection	Description
Input En	A positive edge (0 to 1 transition) at input En (Enable) sets the output AQ to the average value of input Ax after the configured time. A negative edge (1 to 0 transition) holds the output at its last calculated value.
Input R	A positive edge (0 to 1 transition) at input R (Reset) resets the output AQ to 0.
Input Ax	Input Ax is one of the following analog signals: Analog Inputs Analog Outputs Analog Flags The block number of a function with analog output
Parameter	St (Sampling time): You can set it to Seconds, Days, Hours or Minutes. Range of values: If St = Seconds: 1 to 59 If St = Days: 1 to 365 If St = Hours: 1 to 23 If St = Minutes: 1 to 59 Sn (Number of samples): Range of values: If St = Seconds: 1 to St*100 If St = Days: 1 to 32767 If St = Hours: 1 to 32767 If St = Minutes and St ≤ 5 minutes: 1 to St*6000 If St = Minutes and St ≥ 6 minutes: 1 to 32767

Output AQ

AQ outputs the average value over the specified time of sampling.

* Analog Inputs: 0 to 10 V corresponds with 0 to 1000 (internal value).

Parameter St and Sn

Parameter St represents the sampling time and parameter Sn represents the number of samples.

Timing diagram

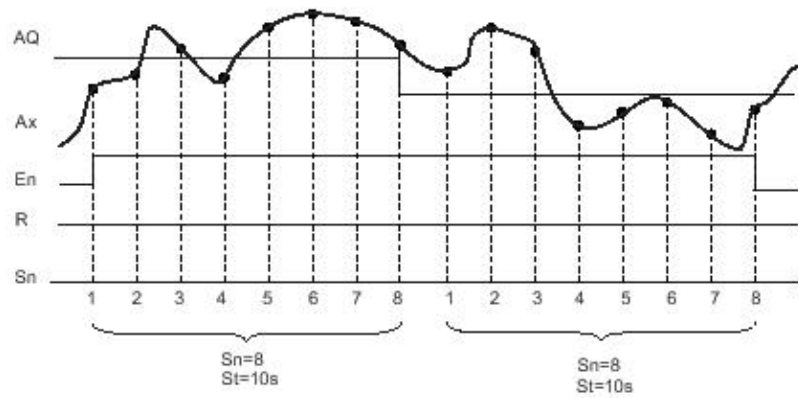

Description of the function

When $En = 1$, the average value function calculates the average value of the samples during the configured time interval. At the end of the sampling time, this function sets output AQ to this calculated average value.

When $En = 0$, the calculation stops, and AQ retains the last calculated value. When $R = 0$, AQ is reset to 0.

5.5.45 Comport Status

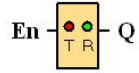

Short description

This function block is used to monitor the communication status of the RS232 (programming port), RS485 port.

With the text message block, we can insert the com port status from such function block for displaying on the LCD.

Connection	Description
En	Enable the function block if a HI level at En input pin and if a trigger from HI to LOW, the function would be disabled.
Parameter	Channel: RS232 RS485 Timeout: 1—100s Monitor type: TX RX TX+RX
Output	When a HI level at the En pin and the timeout is reached the output will be HI, and it will be reset when the En is switched.

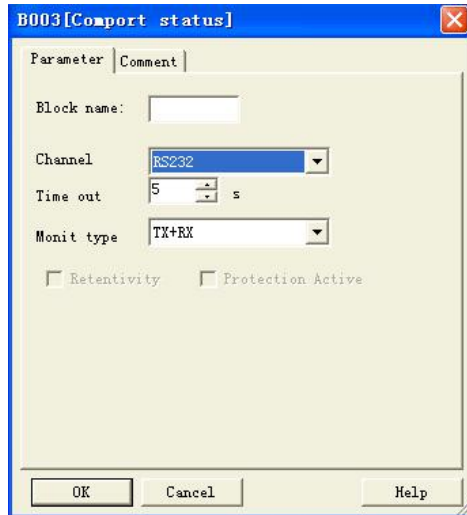

Parameters

Channel

RS232: This channel is the programming port, it can be used to monitor or display the communication status of the below accessories:

FLC-RS232 cable

FLC-USB cable

RS485: This channel is the RS485 port, it can be used to monitor or display the communication status of the below accessories:

FLC-18 CPUs

FLC-RS485

Monitor type

Tx : Data from CPU to external devices.

Rx: Data from external device to CPU

Tx+Rx: Data transmission between external device and CPU.

Description of the function

In order to monitor the communication status of the RS232, RS485, we can enable such function block, when the timeout period exceeds, such block shall output a high level trigger.

How to insert the com port status to the text message for displaying?

Put the "com port status" into program.

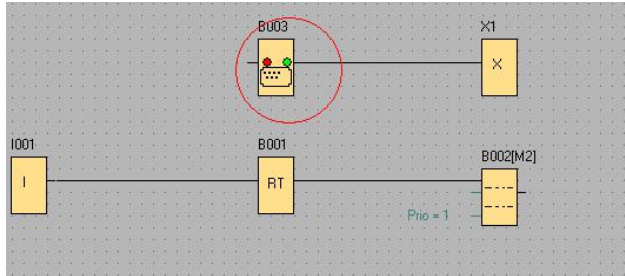

Select "BLOCKS" in the text message property block.

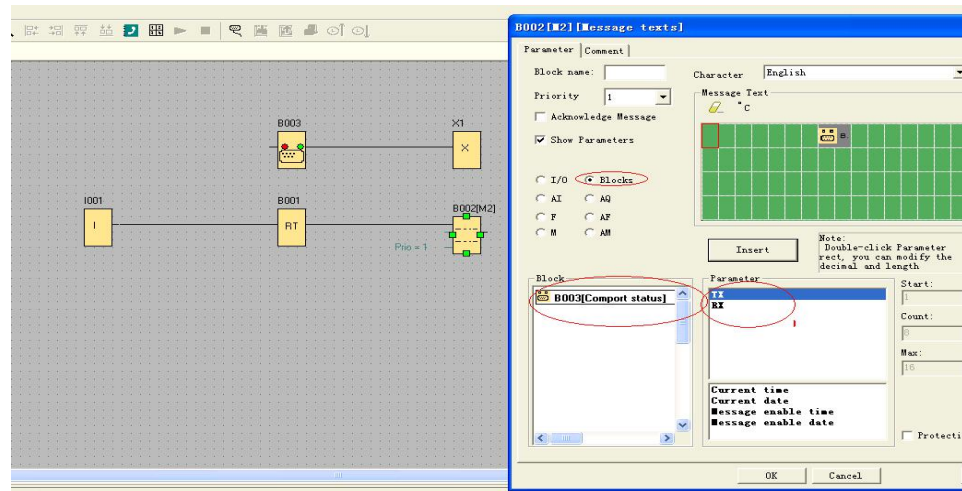

1. Select TX or Rx and insert into the screen.
2. You can edit the text in the screen, such as TX:,RX:

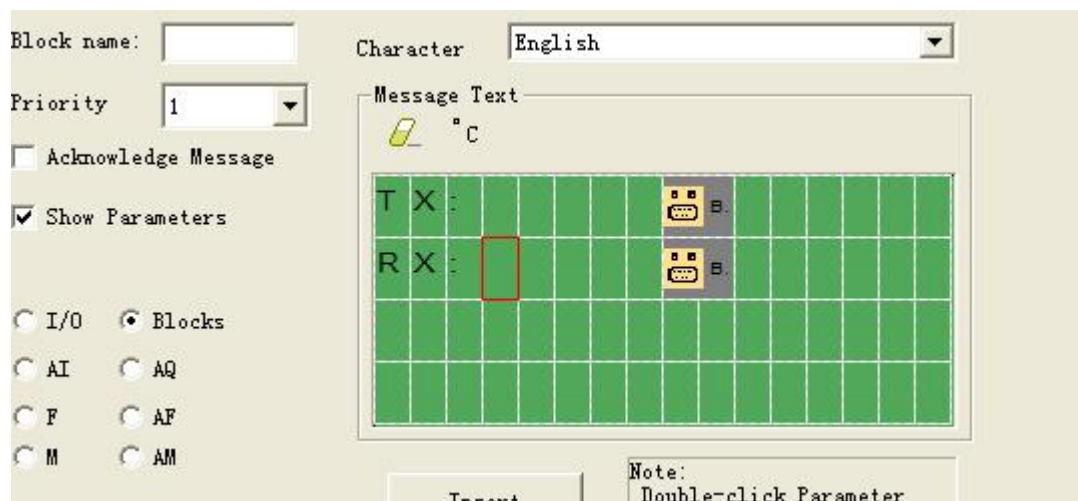

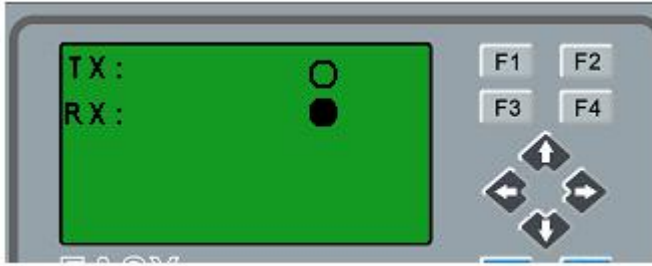

So, you can view the communication status on the LCD, even if there are no indicators on the FLC-RS232/FLC-USB.

If there is data transmission, the status of the com port on the LCD will be flashing.

5.5.46 Astronomical clock



Short description

The astronomical clock SFB is used to set an output high between sunrise and sunset based on the local time at the geographical location of the FLC devices. The output status of this function block also depends on the configuration of summer time/wintertime conversion.

Connection Description

Parameter

The location info including longitude, latitude and time zone.

Output Q

Q is set to hi when sunrise time is reached. It holds this state until sunset time is reached.

Parameters

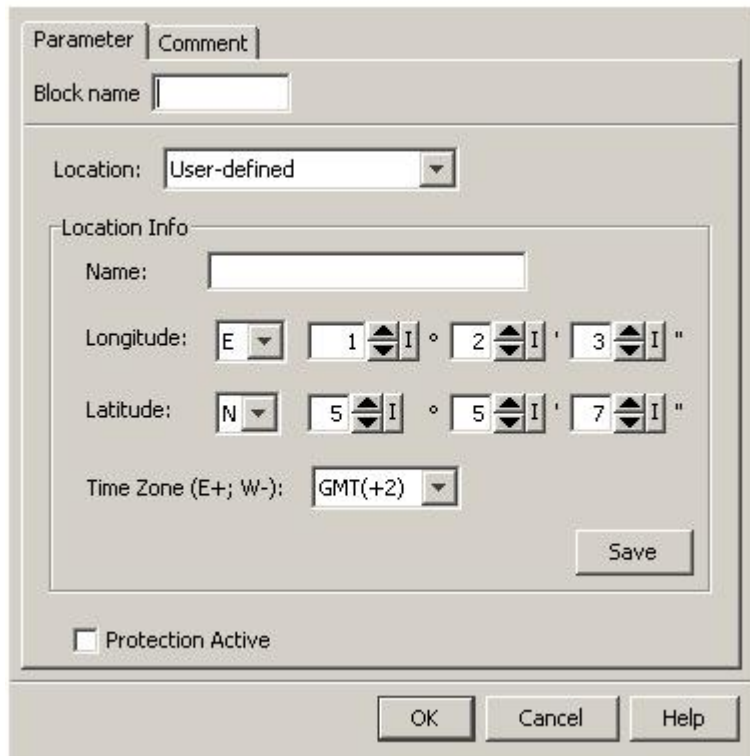

In the astronomical clock dialog, you can select the location of the FLC device. You can select one of following pre-defined time zone locations:

- Beijing
- Berlin
- London
- Rome
- Moscow
- Tokyo
- Washington
- Ankara
- Madrid
- Amsterdam

If you select one of these locations, FLC Logic Soft uses the latitude, longitude, and time zone of your selection.

Alternatively, you can configure a specific latitude, longitude, and time zone for your location, and provide a name for this custom location.

Based on the location and time zone, FLC calculates the absolute sunrise and sunset time for the current day. The block also takes summer time/winter time into consideration, if it is configured on the computer where FLC Logic Soft is installed. To do such configuration, you should select check box of "Automatically adjust clock for daylight for saving changes" in the "Date and Time Properties" dialog.

Timing diagram

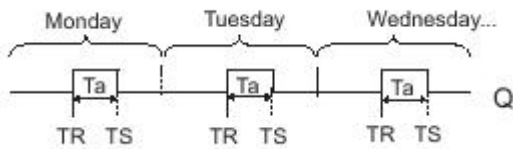

Description of function

The function calculates the value at the input and sets or resets Q depending on the sunrise time and sunset time at the configured location and time zone of the module.

5.5.47 Cam Control

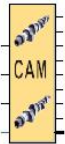

Short description

The cam programmer function Cam Control is used to control a set of 8 built-in cam wheels.

On its 8 outputs (representing the 8 wheels), the function provides the state corresponding to the current position of the shaft wheels. The cam configuration can be set for each position, output state is adjustable. Once the maximum value has been reached, the cam restarts from its initial position (output returns to 0).

Connection	Description
Input Forward	MOVE FORWARD is the input which is used to control cam progress; it moves one step forward at each rising edge (digital status is changed from 0 to 1).
Input Reverse	MOVE BACKWARD is the input which is used to control backward cam movement; it moves one step backward at each rising edge (digital status is changed from 0 to 1).
Input Reset	RESET (initialization): When this input is active, the cam is replaced to its initial position: the POSITION output will be forced to 0.
Output Output1.. Output8	The status of the 8 outputs is corresponding to the current position of the shaft (representing the 8 wheels).
Position	analog output corresponding to the current cam position (0 to 49).
Parameters	From the property dialog box, you may adjust: The number of program steps: Its value is between 1 and 50, Output status [1..8]: for each position of the shaft.

The following figure shows an example of a part of parameters window:

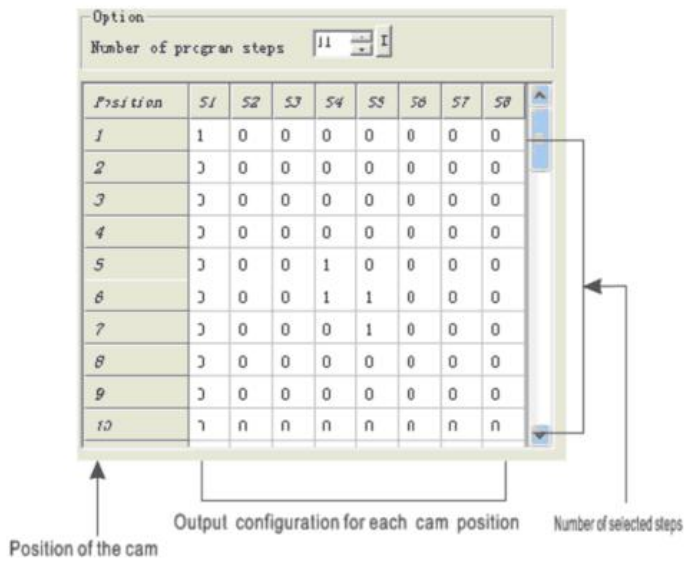

Notes:

1. The FORWARD input takes priority over the BACKWARD input.
2. If the FORWARD and REVERSE inputs are not connected, they are set to inactive.

When selected, the "Retentivity" enables the current value of the timer to be retrieved following a power failure.

5.5.48 Angular Cam Timer



Short description

This function block is used to describe operation of a cam timer based on the angle made by the cams as the analog input. The number of steps can be selected and each step corresponds 2 configurable outputs.

Connection	Description
Input VALIDATION:	Enables the function. If this input is not activated, the function remains inactive. Activated implicitly if it has not been connected.
Input ANGLE:	Timer command input (from 0° to 359°). The outputs vary according to this value

	and the OUTPUT STATE parameter.
Output OUTPUT 1 :	Output 1 is related to the value in the OUTPUT 1 column in the OUTPUT STATE table. If the value of the angle in the ANGLE input is higher or the same as a value N in the ANGLE column in the OUTPUT STATE table and less than the value N+1 in the table, the value of the corresponding OUTPUT 1 column is copied to OUTPUT 1 (1 => output at ON, 0 => output at OFF).
Output OUTPUT 2 :	Output 2 is related to the value in the OUTPUT 2 column in the OUTPUT STATE table. If the value of the angle in the ANGLE input is higher or the same as a value N in the ANGLE column in the OUTPUT STATE table and less than the value N+1 in the table, the value of the corresponding OUTPUT 2 column is copied to OUTPUT 2 (1 => output at ON, 0 => output at OFF).
Parameters	NUMBER OF DEGREES: Equivalent to the wheel step number (2 to 72 steps of 5° to 180°). \ OUTPUT STATES: Table is listing the output states for each position. These states can be modified by left-clicking in the corresponding boxes.

5.5.49 Pumps Management



Short description

APPLICATION-SPECIFIC FUNCTION: PUMPS MANAGEMENT: (TANK MANAGEMENT WITH CIRCULAR PUMP CHANGEOVER).

This function is used to set to ON a maximum of four digital outputs which can be activated (OUTPUT 1 ... OUTPUT 4). This number is equal to the maximum number of digital inputs (from 2 to 4) in the ON state. In addition, the outputs set to ON are selected so that in the event of prolonged operation, each output will have been set to ON the same number of times.

The ON duration of the outputs is set to equal values by applying the following technique:

As the number of ON inputs increases, the outputs changing to ON are those following the order of the PILOT OUTPUT NUMBER: 1 for OUTPUT 1, 2 for OUTPUT 2, 3 for OUTPUT 3 and 4 for OUTPUT 4. For example, if the "outputs controlled" parameter has the value 4, if PILOT OUTPUT NUMBER has the value 3 and just one input is set to ON, only the OUTPUT 3 output will be set to ON. As soon as two inputs change to ON, the OUTPUT 3 output remains at ON and the OUTPUT 4 output changes to ON. As soon as a third input changes to ON, the OUTPUT 3 and OUTPUT 4 outputs remain ON and OUTPUT 1 changes to ON.

As soon as the number of outputs decreases, the outputs changing to OFF will be those which have been in the ON state the longest. As soon as one output changes to OFF, PILOT OUTPUT NUMBER takes the value of the output number after the output(s) which has (have) just been set to OFF. To complete the

above example, as soon as one input changes to OFF, the OUTPUT 3 output changes to OFF and PILOT OUTPUT NUMBER displays the integer value 4.

The Parameters tab in the property box contains the number of outputs which may change to ON depending on the number of inputs which are set to ON. The values of this parameter are fixed at 2, 3 or 4.

If the value of the parameter is fixed at 2, only the OUTPUT 1 and OUTPUT 2 outputs are used and may therefore change to ON. In this case, if more than two inputs change to ON, the OUTPUT 1 and OUTPUT 2 outputs remain at ON and the OUTPUT 3 and OUTPUT 4 outputs remain fixed at OFF.

If the value of the parameter is fixed at 3, only the OUTPUT 1, OUTPUT 2 and OUTPUT 3 outputs are used and may therefore change to ON. In this case, if four inputs change to ON, the OUTPUT 1, OUTPUT 2 and OUTPUT 3 outputs remain at ON and OUTPUT 4 remains fixed at OFF.

If the value of the parameter is fixed at 4, only the OUTPUT 1, OUTPUT 2, OUTPUT 3 and OUTPUT 4 outputs are used and may therefore change to ON.

All inputs which are not connected have the value OFF.

When the program is initialized, PILOT OUTPUT NUMBER is fixed at 1.

The Parameters tab contains the default check box which re-initializes PILOT OUTPUT NUMBER to 1 (and defines the first output activated when the first input changes to 1) after a controller power failure.

Example of use:

Filling a tank with a group of four pumps operating in parallel. The operating duration of each pump is the same.

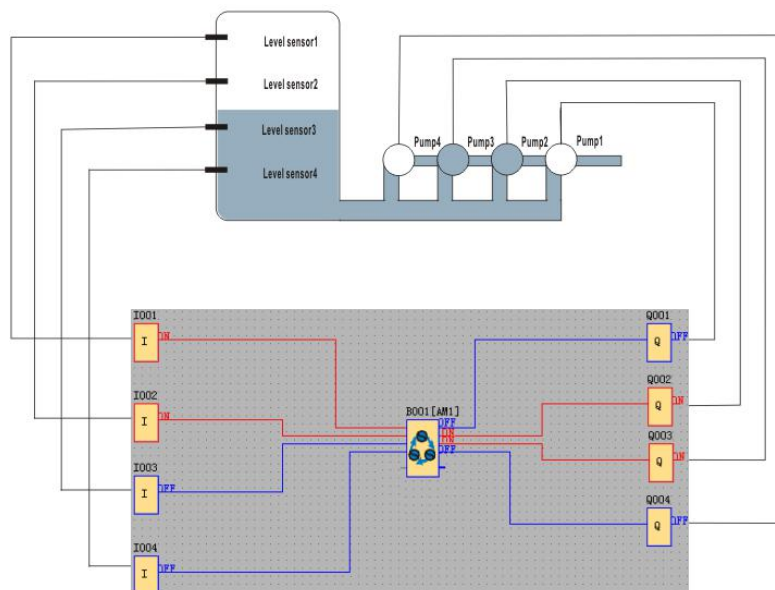

The "number of outputs controlled" parameter is fixed at 4.

On initialization, PILOT OUTPUT NUMBER has the value 1. On initialization, if the tank is in the state indicated and if a sensor above the water is in the ON state, when the user program is executed, the INPUT 1 and INPUT 2 inputs are ON, INPUT 3 and INPUT 4 are OFF and OUTPUT 2 and OUTPUT3 are ON.

Assuming that the tank is full, INPUT 2 changes to OFF and OUTPUT 1 changes to OFF. PILOT OUTPUT NUMBER indicates the value 2.

Assuming that the tank is empty, INPUT 2 changes back to ON, OUTPUT 3 changes to ON and OUTPUT 2 remains ON.

Assuming that the tank refills, INPUT 2 changes back to OFF, OUTPUT 2 changes to OFF and PILOT OUTPUT NUMBER indicates the value 3.

Assuming that the tank continues to refill, INPUT 1 changes to OFF, OUTPUT 3 changes to OFF and PILOT OUTPUT NUMBER indicates the value 4.

5.5.50 Defrost

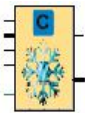

short Description

The defrost output changes to ON when the input temperature is less than the minimum temperature for a time T (T being the cumulative duration of passages below the minimum temperature). If the temperature rises to higher than the maximum temperature during the defrost cycle, the defrost output reverts to OFF even if it has not finished. This output can be triggered and stopped by means of the corresponding inputs.

Connection	Description
Input VALIDATION	function validation input. The function remains inactive for as long as this input is not activated. VALIDATION is implicitly active if it is not connected.
Input TEMPERATURE	Air temperature in °C*100 (-32768°C to 32767°C).
Input MANUAL DEFROST ON	Sets the defrost output to ON if the temperature is less than the maximum temperature.
Input MANUAL DEFROST OFF	Sets the defrost output to OFF (Priority stop).
Output DEFROST	The defrost output is at ON when the CUMULATIVE OPERATING TIME has elapsed.

<p>Output CUMULATIVE TIME:</p>	<p>Measured duration, in minutes, when the temperature is less than the minimum temperature or duration of the current defrost cycle.</p>
<p>Parameters</p>	<p>CUMULATIVE OPERATING TIME: Time T, in minutes, at the end of which the function triggers defrosting (1 to 32767). DEFROST CYCLE: Duration of defrosting in minutes (1 to 32767). MAXIMUM TEMPERATURE: Temperature in °C above which defrosting is stopped (10°C ... 20°C). MINIMUM TEMPERATURE: Temperature in °C below which the time T is measured (-10°C ... 0°C).</p>

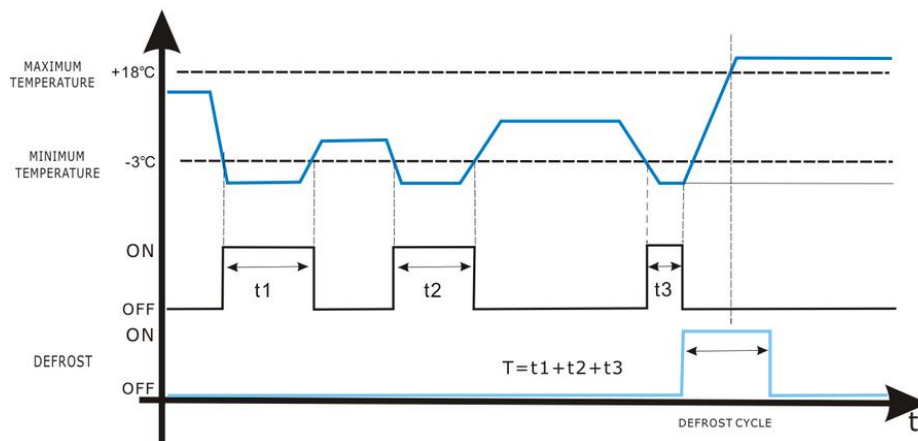

5.5.51 Comparison of 2 values



Short Description

The COMPARE function is used to compare two analog values.

Connection	Description														
Input ENABLE FUNCTION	an ENABLE FUNCTION Discrete-type input														
Input VALUE 1	Integer-type input														
Input VALUE 2	Integer-type input														
Function	<p>If the VALUE 1 or VALUE 2 input is not connected, the value is set to 0.</p> <p>The function provides a discrete-type OUTPUT.</p> <p>The output is active if the result of the comparison between VALUE 1 and VALUE 2 is true and if the ENABLE FUNCTION input is active or not connected.</p> <p>The output does not change state if the ENABLE FUNCTION input changes from Active to Inactive state.</p>														
Parameters	<p>The comparison operators that can be chosen from the Parameters window are:</p> <table border="0"> <thead> <tr> <th>Symbol</th> <th>Description</th> </tr> </thead> <tbody> <tr> <td>></td> <td>Greater than.</td> </tr> <tr> <td>≥</td> <td>Greater than or equal to.</td> </tr> <tr> <td>=</td> <td>Equal to.</td> </tr> <tr> <td>≠</td> <td>Different.</td> </tr> <tr> <td>≤</td> <td>Less than or equal to</td> </tr> <tr> <td><</td> <td>Less than</td> </tr> </tbody> </table>	Symbol	Description	>	Greater than.	≥	Greater than or equal to.	=	Equal to.	≠	Different.	≤	Less than or equal to	<	Less than
Symbol	Description														
>	Greater than.														
≥	Greater than or equal to.														
=	Equal to.														
≠	Different.														
≤	Less than or equal to														
<	Less than														

5.5.52 Multicompare

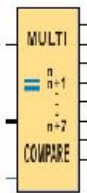

Short Description:

This function is used to activate the output corresponding to the value present on the "Value" input.

Connection	Description
Input VALIDATION	Function validation input. Until this input is activated, the function remains inert. Validation is active implicitly if it has not been connected.
Input VALUE	Value to be compared.
Outputs	<p>VALUE N: Output ON if Value = Value N.</p> <p>VALUE N + 1: Output ON if Value = Value N + 1.</p>

	<p>VALUE N + 2: Output ON if Value = Value N + 2.</p> <p>VALUE N + 3: Output ON if Value = Value N + 3.</p> <p>VALUE N + 4: Output ON if Value = Value N + 4.</p> <p>VALUE N + 5: Output ON if Value = Value N + 5.</p> <p>VALUE N + 6: Output ON if Value = Value N + 6.</p> <p>VALUE N + 7: Output ON if Value = Value N + 7.</p>
--	---

Operation:

The comparison value (Value N) can be configured. It must be between 0 and 32760.

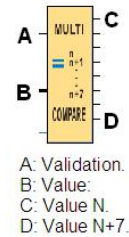

5.5.53 Compare in zone



Short Description

The COMP IN ZONE comparison function is used to compare one value between two set points (the MIN and MAX values of the zone).

Connection	Description
Input ENABLE	A discrete ENABLE FUNCTION input; this input is Active if it is not connected.
Input VALUE TO COMPARE	The value is used to be compared with the min and max value, whose type is Integer.
Input MIN VALUE	A MIN VALUE input, whose type is Integer
Input MAX VALUE	A MAX VALUE input, whose type is Integer
OUTPUT	The OUTPUT indicates the result of the comparison when the ENABLE FUNCTION input is active. The OUTPUT does not change state when the ENABLE FUNCTION input is inactive.
Parameters	From the Parameters window, you can select the state of the output according to the result of the comparison: ON in the zone: the output will be active if the input value is between the two set points (MIN and MAX), OFF in the zone: the output will be inactive if the input value is between the two

	<p>set points (MIN and MAX).</p> <p>If MINI is greater than MAXI, then for:</p> <p>ON in the zone: the output always remains inactive,</p> <p>OFF in the zone: the output always remains active.</p>
--	--

Comparison Function

The diagram below shows the different states the output can take, depending on the input value to compare and the enable input:

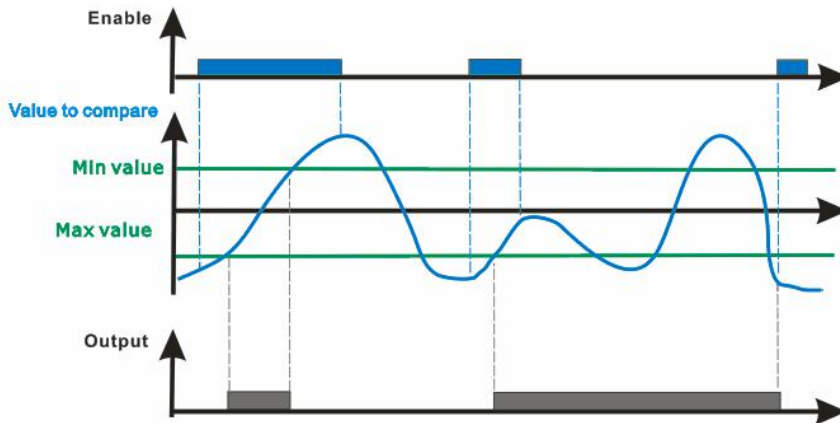

5.5.54 Conversion Word bits



Short Description

When the "En" is high, The DEC/BIN function breaks down an integer (16-bit) type input into 16 bit-type outputs.

Illustration:

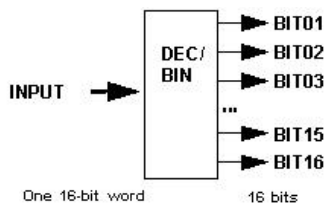

Inputs/Outputs

This function supports 1 integer type 16-bit input:

This function supports 16 discrete outputs: BIT01 (least significant byte) ... BIT16 (most significant byte).

5.5.55 Conversion bits Word



Short Description

When the "En" is high, the BIN/DEC function produces a 16-bit integer-type output from 16 inputs of the following type: Bit

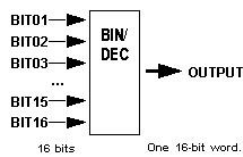

Inputs/Outputs

This function supports 16 discrete inputs: BIT01 (least significant byte) ... BIT16 (most significant byte). This function supports one 16-bit integer-type output.

5.5.56 Demultiplexer



This function demultiplexes integers. It is used to route the input value onto one of the 4 OUTPUTS on each rising edge of the VALIDATION input.

A VALUE copied to an output does not revert to 0 when a VALUE is written to another ADDRESS.

The BASE ADDRESS parameter allows several blocks to be used at the same time to multiply outputs.

The Parameters tab contains:

BASE ADDRESS: Contains the address of the ADDRESS 1 output.

Retentivity: Chooses whether or not the function is reinitialized if the controller power supply is disconnected.

When they are not connected, the ADDRESS and VALUE inputs are set to zero.

Example:

When the BASE ADDRESS parameter contains the value 0 these outputs have addresses 0, 1, 2, 3 respectively, and in this case if the ADDRESS input equals 2 the VALUE will be copied to the third output.

If a second block is being used, 8 outputs can be demultiplexed by putting the value 4 as the BASE ADDRESS in the second block and connecting the VALIDATION and ADDRESS inputs to the same source.

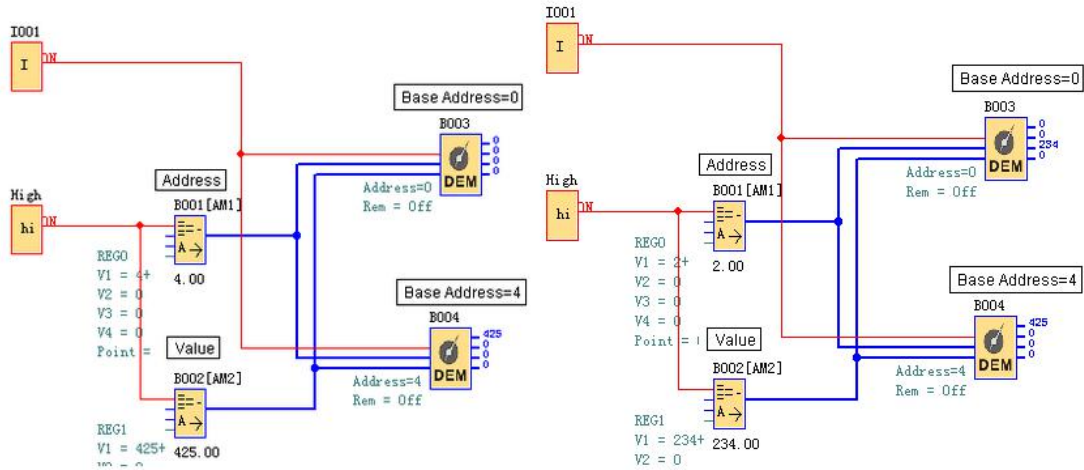

5.5.57 Multiplexing

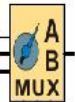

Short Description

The MUX function carries out two input channel multiplexing on the OUTPUT.

Connection	Description
Input CHANNEL A	this is the multiplexer input A, whose type is integer.
Input CHANNEL B	this is the multiplexer input B, whose type is integer.
Input SELECTION	this input is used to choose the input channel to apply to the output.
Output	this is the multiplexer output. This value depends upon the state of the SELECTION input. If the SELECTION input is: inactive: the OUTPUT corresponds to CHANNEL A, active: the OUTPUT corresponds to CHANNEL B.

Notes: 1. If the SELECTION input is not connected, then it is considered to be inactive.

2. If CHANNELS A or B are not connected, then they are set to 0.

5.5.58 Multiplexer

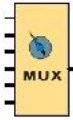

Short Description

This function multiplexes the WORD inputs. It is used to route the value of one of the inputs selected by the ADDRESS input to the output. The input is routed to the output on each rising edge of the VALIDATION input.

The BASE ADDRESS parameter allows several blocks to be used at the same time to multiply inputs.

The Parameters tab contains:

BASE ADDRESS (corresponding to Input 1): Contains the address of the INPUT 1 input.

Retentivity: Chooses whether or not the function is reinitialized if the controller power supply is disconnected.

When they are not connected, the digital input is in the OFF state and the WORD inputs contain 0.

Example:

When the BASE ADDRESS parameter contains the value 0 these inputs have addresses 0, 1, 2, 3 respectively, and in this case if the ADDRESS input equals 2 the VALUE of the third input will be copied to the output.

If a second block is being used, 8 inputs can be demultiplexed by putting the value 4 as the BASE ADDRESS in the second block and connecting the VALIDATION and ADDRESS inputs to the same source.

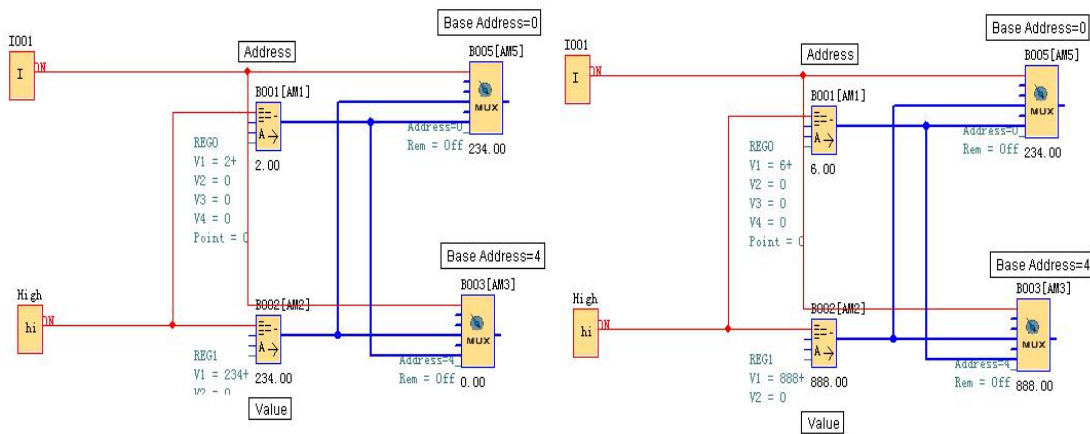

5.5.59 Square Boot



Short Description:

This function is used to calculate the square root of the number present as an input with accuracy to two decimal points.

Connection	Description
Input Validation	Function validation input. Until this input is activated, the function remains inert. Validation is active implicitly if it has not been connected.
Input Calculation input	The value must be between 0 and 32767.
Output Calculation output	Calculation output: The result is presented in the format "Root" x 100.

Operation:

Example: for X = 20000 => Root of X = 141.42. The value read as an output of the function is 14142.

If used as an input, the number is negative and the result is 0.

Performance:

The calculation is accurate to 0.01 either way.

5.5.60 Sin Cos



Short Description

This function is used to calculate the cos and sin of an angle between 0° and 90°.

Connection	Description
Input Validation	Function validation input. Until this input is activated, the function remains inert. Validation is active implicitly if it has not been connected.
Input Angle	Represents the angle in degrees. Its value must be between 0 and 900 for an angle between 0° and 90°.
Output Sin	Result of ("Angle" sin) x 10000
Output Cos	Result of ("Angle" cos) x 10000

Performance:

The function calculates the cos and the sin to the nearest 0.0001 by rounding up or down as appropriate.

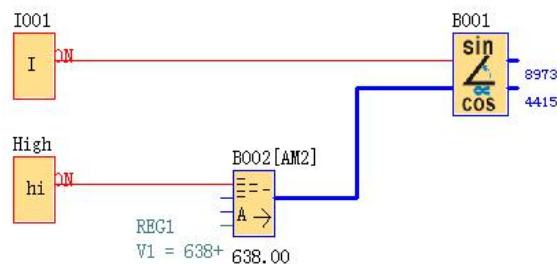

Sin (63°8) = 0.8973 and Cos (63°8) = 0.4415

5.5.61 Absolute Humidity



Short Description

This function is used to calculate the absolute humidity.

Connection	Description
Input En	Enable the function
Input T	Temperature
Output RH	Humidity
Output AQ	Absolute humidity

Calculate rule:

B001 [AH1] [Absolute Humidity] ✖

Parameter	Comment	
Block name:	<input type="text"/>	<input checked="" type="checkbox"/> Show Parameters
V1	<input type="text" value="8.112"/>	$\frac{6.112 \times e^{\left[\frac{17.67 \times T}{T + 243.5} \right]} \times rh \times 2.1674}{273.15 + T}$
V2	<input type="text" value="17.67"/>	
V3	<input type="text" value="243.5"/>	
V4	<input type="text" value="2.1674"/>	
V5	<input type="text" value="273.15"/>	
Decimals in the message text		<input type="text" value="0"/> +12345
<input type="checkbox"/> Retentivity		<input type="checkbox"/> Protection Active

5.6 FLC Logic Soft

You now see the complete user interface of FLC Logic Soft. The programming interface for creating your circuit programs occupies the greater part of the screen. The icons and logical links of the circuit program are arranged on this programming interface.

To help you to maintain an overview of large circuit programs, the right side and the bottom of the programming interface contains scroll bars, which you can use for vertical and horizontal scrolling of the circuit program.

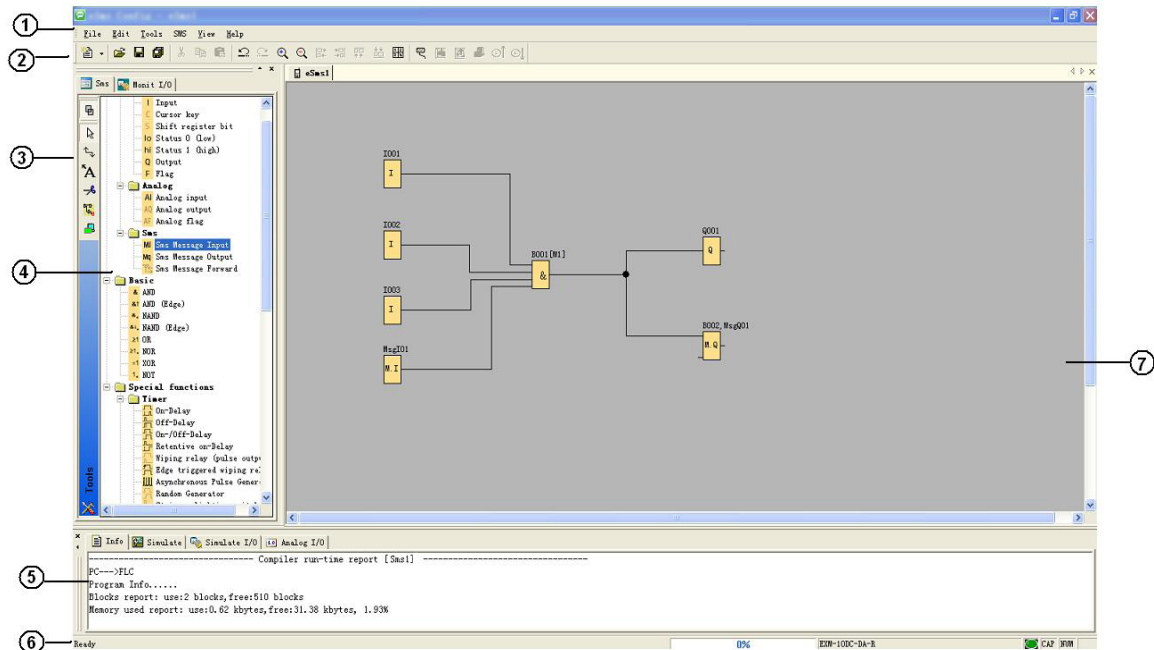

1. Menu bar
2. Standard Toolbar
3. Programming Toolbar
4. Reference material (Function block list)
5. Info box (Display memory Info, IO status and analog IO values under simulation/monitoring mode)
6. Status bar (Including current operation, current CPU model and the communication status)
7. Programming Interface

Notes: For the detailed operation, please refer to Chapter 10 and Chapter 11 of this part.

5.7 Main Functions

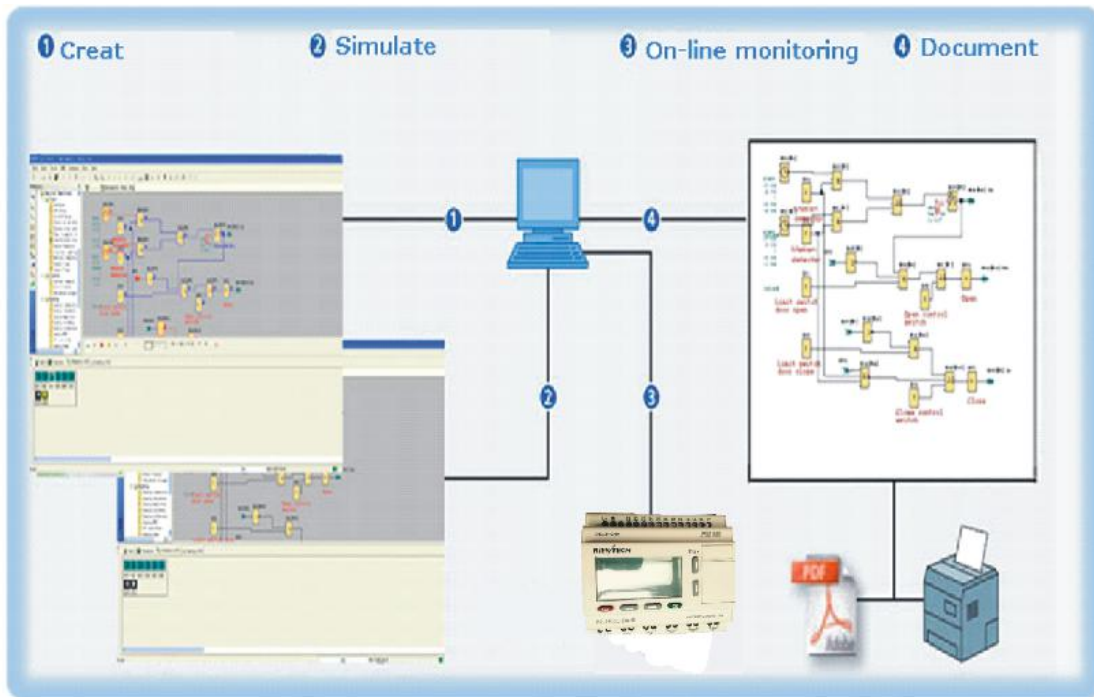

1. Edition function

The main function of FLC Logic Soft is programming for FLogic FLC. By using the Logical Function Edition window of FLC Logic Soft, you can create and edit your desired FLC programs using various function blocks of FLC and can also perform file operations such as save, print, program management etc.

2. Simulation operation function

After the program is edited, you can view the program operation result on the computer and conveniently check if the said program meets your control requirements. Here FLC Logic Soft provides you with a completely new off-line test function, through which you can debug the program without installing the FLC on site. With this function, many inconvenience of the site test can be avoided.

3. Real-time monitoring

FLC Logic Soft has a Real-Time Monitoring window. You can view the process of the control system and the running conditions of all FLC and control remote FLC, by connecting the FLC communication port (RS232, USB) to the computer you can view the process of the control system.

4. Document

The program circuit can be saved and printed. The analog values also can be saved in one excel file.

5.8 Operation Instructions

5.8.1 Menu Bar

When FLC Logic Soft is used to edit FLC programs under customized mode, some basic operations including files management, opening and closing of the Tool Bar and Status Bar access to Help information are completed by using pull-down menu under File, Edit, Tools, View and Help. The Instruction Function list of FLC Logic Soft is characterized by its flexibility and variation according to the main selection.

It can be changed according to the current operation for convenience of your specific operations.

5.8.1.1 File

The instruction is mainly used for file management, including creation, opening, saving and printing of files.

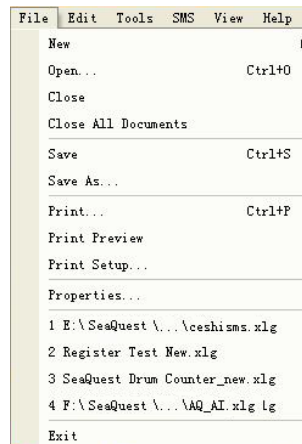

Fig. 10.1 File Menu

Instruction Name	Function
New	Open a new file
Open	Open an old file
Close	Close the current active Window
Close All Documents	Close all the current active Windows
Save	Save a file
Save As	Save current file to a new path and a new file
Print	Print a file
Print Preview	Preview the file printing result
Print Setup	Setup printing format
Property	File property(page size &model select)
Exit	Exit the FLC Logic Soft

5.8.1.2 Edit

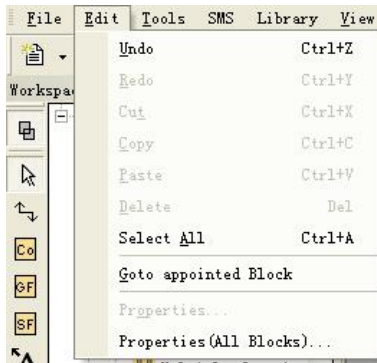

Fig. 10.2 Edit Menu

- ※ Undo: Undo the previous step operation and support consecutive operations.
- ※ Redo: Recover the contents undone by the previous step of operation and support consecutive operations.
- ※ Cut: Cut the contents in the area highlighted with the cursor.
- ※ Copy: Copy the contents highlighted with the cursor.
- ※ Paste: Paste the contents cut or copied.
- ※ Delete: Delete various graphic components.
- ※ Select All: Select all the contents in the current window editing box and setup the label.
- ※ Goto Apponited block: Goto the apponited block in the program interface.
- ※ Property: open the property box of the apponited block
- ※ Properties (all blocks): Open all the property boxes of the selected blocks.
- ※ Phonebook: Add/Delete phone number into phonebook Refer to the chapter

5.8.1.3 Tools

This instruction is mainly used for reading program from FLC, writing program to FLC, diagnosis the communication situation of FLC, program management and simulation and so on. The pull down menu of Tools is shown as the following:

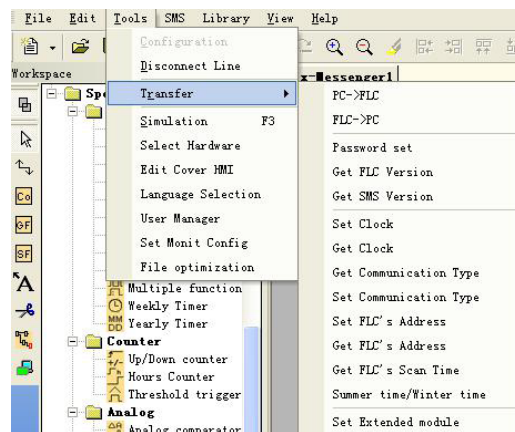

Fig. 10.3 Tools Menu

- ※ Configuration: Select and open the Com port.
- ※ Disconnect Line: Cancel the connection of PC and FLC.
- ※ Transfer: Transfer the following data between PC and FLC.
 - PC-> FLC: Download the program to FLC.
 - FLC->PC: Upload the program from FLC.
 - Password set: Set Password protection to FLC.
 - Get FLC Version: Get the current FLC hardware version.
 - Set Clock: Set RTC for FLC.
 - Get Clock: Get RTC from FLC.
 - Get Communication Type: Get current communication type
 - Set Communication Type: Set communication type for current FLC
 - Set FLC's address: Set the current FLC address
 - Get FLC's address: Get the address of current FLC
 - Get FLC's scan time: Get the scan period of the FLC for current program Summer time/
 - Winter time: Activate/disable the conversion of the summer/ winter time Set Extended
 - module: Activate/disable the expansion port of FLC (Only applied to Standard FLC-12 series CPU).

- ※ Simulation: simulate the FLC program.
- ※ Select Hardware: Select the model of FLC for programming.
- ※ Edit Cover HMI: Customers are allowed to edit the first page of the HMI by this menu.
- ※ User manger: File management, program can be protected with different priorities.
- ※ Set monit config: select elements for monitoring or saving with Excel file.

5.8.1.4 SMS

- ※ Set Modbus config: Change the MODBUS data format based on the device which will communicate with FLC.

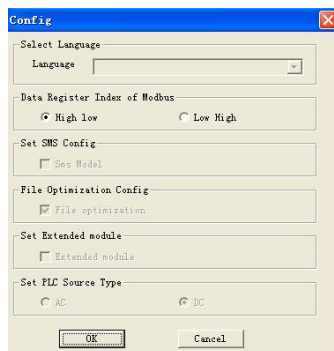

5.8.1.5 View

This instruction is to display the status bar, workspace and the Information window and so on. The pull down menu is shown as the following:

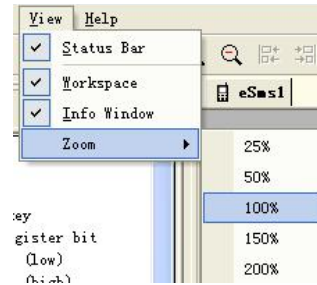
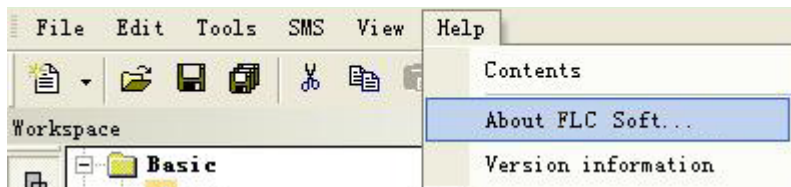

Fig. 10.5 View Menu

- ※ Status bar: state bar displaying instruction
- ※ Workspace: workspace displaying instruction
- ※ Info Window: Info window displaying instruction
- ※ Zoom: window proportion displaying instruction. There are four different sizes of the windows for the user to select.

5.8.1.6 Help



- ※ Content Index: Help index and detailed contents
- ※ About FLC Logic Soft
- ※ Version information

5.8.2 Toolbar

The icons of the standard toolbar provide quick access to commands that are also available on the menu.







Standard Toolbar			
	New		Zoom In
	Open		Zoom Out



	Save		Align Left
	Save All		Align Right
	Cut		Align Top
	Copy		Align Bottom
	Paste		Page Layout Tab
	Undo		Open COM port
	Redo		Download (PC-> FLC)
	On-line monitor		Upload (FLC -> PC)
	Get RTC from FLC		Set RTC to FLC

5.8.3 Programming Toolbar

The programming toolbar contains integral icons for creating, editing and testing programs. Each one of these tools represents a programming mode, in which mouse operations have different effects.

The editing tools are not available as menu commands.

	Catalog of the elements of a circuit program open / close
	Selection Tool
	Text Tool
	Cut/Join
	Connector Tool
	Constants and Terminals
	Basic functions

	Special functions
	Simulation
	On-line test

Selection Tool



You can use the selection tool to select and move blocks, text and connecting lines. You can select objects individually with a left-click; you can select multiple objects with [Ctrl]+Click, or you can use the mouse as a "lasso" to surround objects with a rectangle and capture them as a selection.

You can call the selection tool in any other tool by pressing the [ESC] key or by clicking on the icon in the programming toolbar.

Text Tool



This tool is used to insert or edit user-defined text objects in the programming interface. You can specify the font type, font size and font color for each individual label.

Text figures can be set in Wrap Text format. You can adjust the size of a text figure typically by dragging the rectangle handles.

Cut/Join



This tool is used to cut and join connections between blocks. To cut a connection, left-click to select the relevant line while the Cut/Join tool is active. The connection is replaced at the blocks by a reference to the partner block. The reference is labeled with the page number, block number and the I/O of the partner block.



5.8.4 Simulation Tool and status window

A toolbox pops up when you open the simulation mode. It contains:

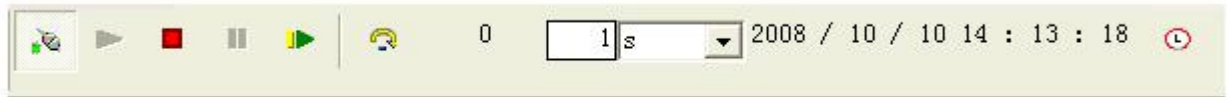
- Icons (e.g. switches) for operator control of the inputs .
- An icon for the simulation of a power failure, for testing the switching response with reference to retentivity characteristics after power failure.
- Icons (e.g. bulbs) for monitoring outputs .
- Simulation control icons and
- Time control icons.





Simulation control icons

	Start simulation
	Stop simulation
	Hold simulation (pause)

Time control

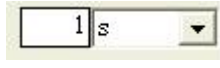
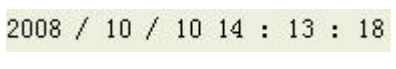
If you have programmed a time-sensitive circuit, you should use the time control to monitor the reaction of your circuit program.

	Start simulation for a specific time or number of cycles. Set the period and the number of cycles using the following icons.
	Setting the period and the time base for a time limited simulation or setting a specific number of cycles
	Display of the current time in FLC Logic Soft
	Modification of the current time in FLC Logic Soft

Status display

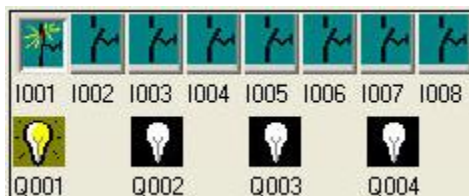

Layout of inputs

The inputs are displayed in the form of key or switch icons. The name of the input is displayed below the icon. An open input represents an inactive switch. When you click on the icon, it is indicated active and the switch is shown in closed state.

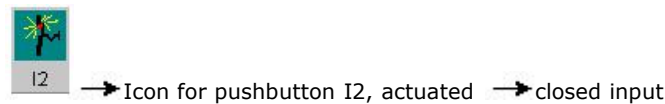
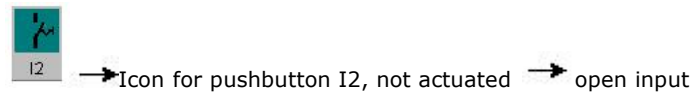
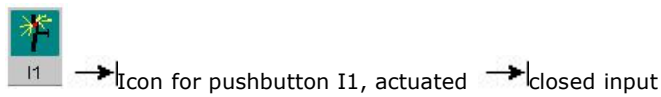
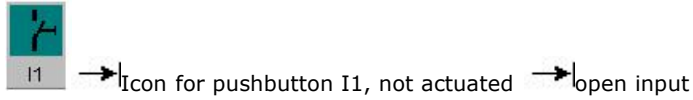

Layout of the outputs

The status of an output is indicated by a light or dark bulb icon. The name of the output in your circuit program is displayed below this icon.

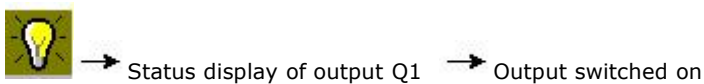
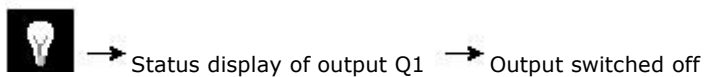

The output status only indicates the status as such. Here, you cannot switch an output by clicking on an icon. When your circuit program switches an output, the indicator lamp is active; when the output is switched off, the indicator lamp is also switched off.

Prerequisite: The display of signal states and process variables is enabled under **Tools**

→ **Simulation.**

The colored indication lets you identify the "1" or "0" status of a connecting line. Default color of connecting lines carrying a "1" signal is red. Default color of connecting lines carrying a "0" signal is blue.

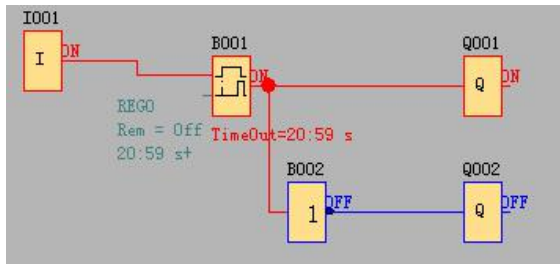

5.9 Basic Operation

This chapter will tell you how to write logic function graph Program with FLC Logic Soft, how to simulate the Program you write with FLC Logic Soft, how to communicate between PC and FLC with FLC Logic Soft, how to copy system document of FLC with FLC Logic Soft, and how to complete the update of application and system Program code. If you want to write a function graph Program, first of all, it's necessary to start an empty document, and then put the function block into editing box. First set the property of every function block, then link every function block according to logic controlling relation, thereby complete the protracting of a logic function graph. In addition, in order to help the users confirm if the function graph accord with the prospective controlling result, FLC Logic Soft also provides most intuitionist function of simulation. You can get the moving result of the program through simulation of the function graph.

5.9.1 Open File

5.9.1.1 Open New File

Operation method:

To open a new file, click 'New' option of menu 'File', click once with left button of mouse. As shown in the following fig.

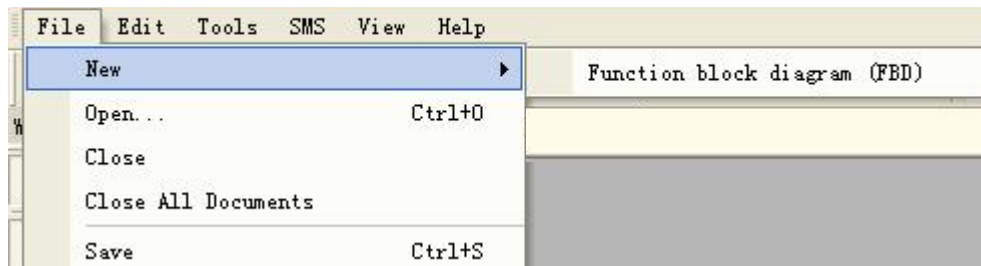

Fig.7. 9.1 Open New Document

Notes: An option Window of outside-meet extended module will appear before a new document opened.

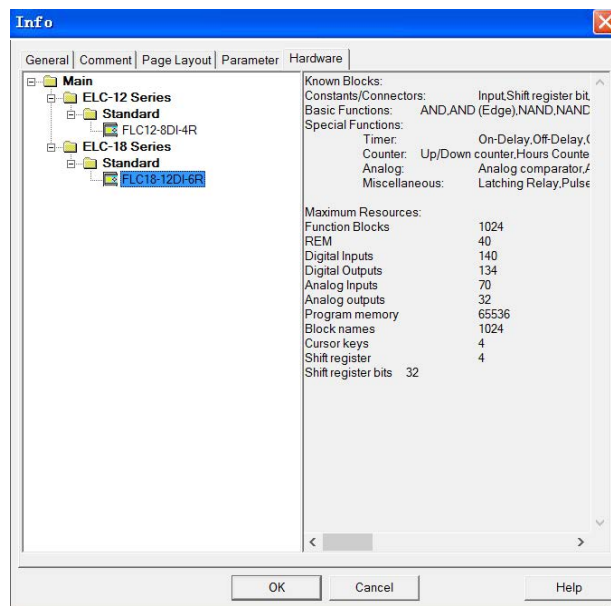
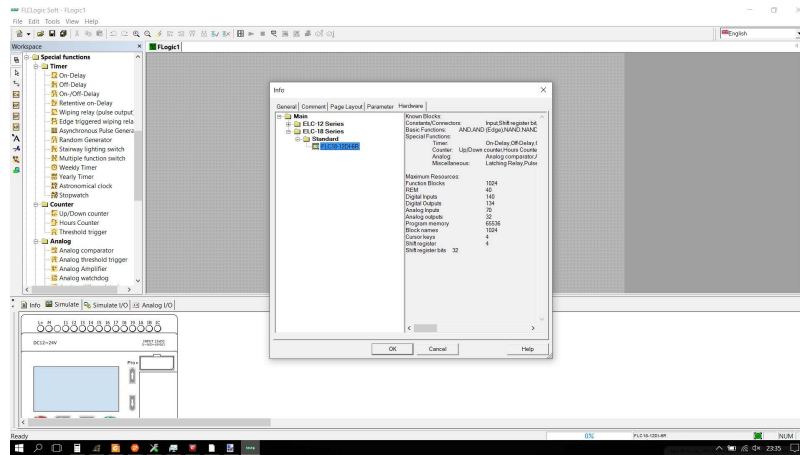

Fig.7. 9.2 Hardware type selection

Page layout set and hardware selection before programming

In the **Page Layout** tab, you can specify how and on how many pages to print your circuit program. You can preview the pagination in this tab. If you choose more than one program page, the page breaks are indicated by white lines on the programming interface.

The **hardware type** selection is also needed be done before programming. The available elements are showing in the right area in the above figure.



Click the payout icon or double click the model displayed area on the right down of the interface, the model selection dialog box also can pop out

5.9.1.2 Open Existed Document

Operation Method:

1. To open a document, click 'Open' option of menu 'File' once with left button of mouse ,or click once in toolbar, shortcut key 'Ctrl+O' also can be used. As shown in Fig. 11.3:

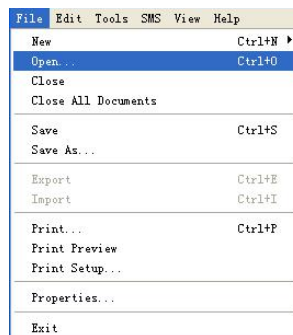

Fig. 7.9.3. Open Existed Document

2. Click 'Open', find the path of saving file, dialogue box as follows:



Fig7.9.4 Dialogue Box of Existed Document

3. Click the file you want to open with left button of mouse, then click button "Open". After

opening the document, you can modify or print the document.

5.9.2 Edit Function Diagram Program

5.9.2.1 Place Function Block

While you set up a new document, you can write your control Program in the new program interface. The method and process of placement is as follows:

The method of placing function block is as follows: choose function block needed from the workspace left of the program interface.

Operation Procedure:

1. Choose corresponding function group. "Constant", "Basic", "Special" list and various blocks can be selected. Refer to the function block instruction chapter 5 for detail instruction of function blocks
2. Click the block you needed with left button of the mouse
3. Move the mouse to the proper place in the program interface, click with left button of the mouse, then complete the placement of a block.
4. According to above operation, put all modules in program interface.

E.g.: To complete all the function block of one certain system control, as Fig 7.10.1 shown, put all function modules into the edit program interface.

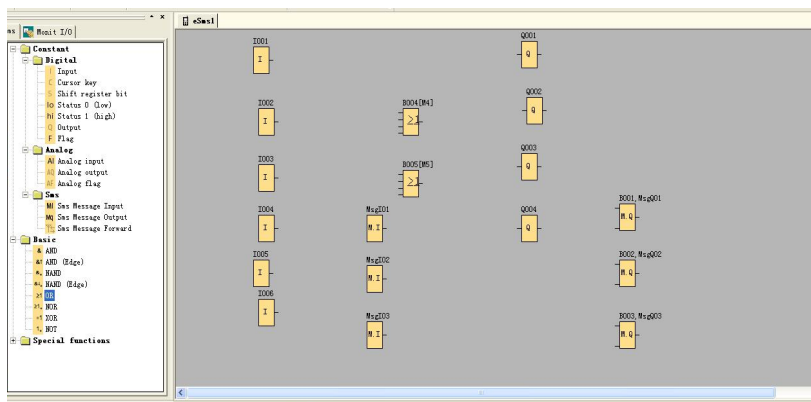

Fig 7.10.1 Place block

5.9.2.2 Edit Property of Function Block

After put all function block in edit box, it's necessary to setup property of every function block. This is the most important step to write function block Program.

Operation Method:

1. In the function block Program interface, click some block twice with left button of the mouse, or pitch on a block and press right button of the mouse, then an edit menu appears, and then click "Properties..." of this menu. As shown in Fig 11.6:

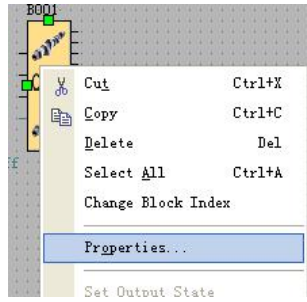

Fig 7.10.2 Block edit menu

2. You also can click the menu Edit-> Properties or Edit-> Properties (all blocks) to change the settings of the block.

Property dialogue box, as shown in Fig 7.10.3, to setup each item of content according to what you need, you also could click "Help" to observe the detail instruction.

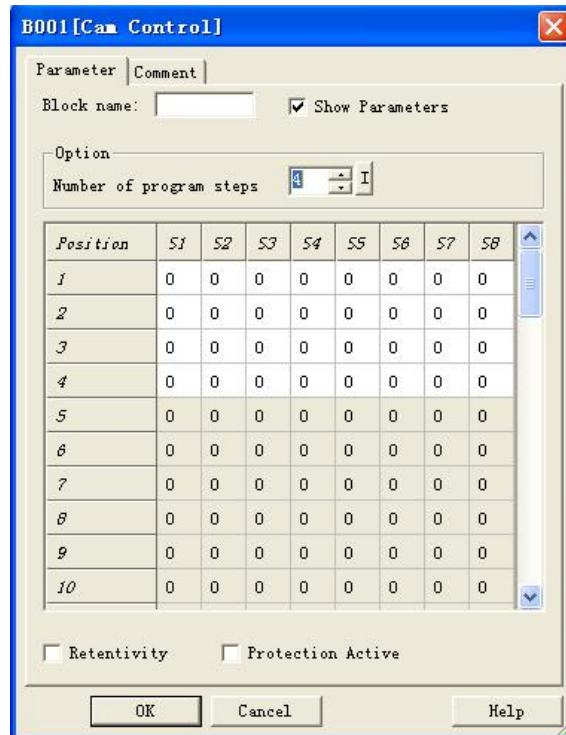



Fig 7.10.3 property box

Note: Different block has different property setup, especially the property of special function block. Please read chapter 5, the explanation to refer the detailed setup.

5.9.2.3 Setup link

After put all the blocks needed in protracting function graph, and set up properties as needed, it's necessary to set up link according to logic control relation and make it an integrated function diagram.

Operation Method:

1. Pitch on shortcut key  , when the mouse becomes the shape of a pen, it can be used to link.
2. To do so, move the mouse pointer to a block input or output and press the left mouse button. Keep the mouse button being pressed down and then drag the mouse pointer from your selected source terminal to the target terminal. Now release the mouse button to anchor the connecting line to both terminals. While the connecting line is being drawn, it is shown as a straight line between the first terminal and the mouse pointer. Once it is anchored, it appears as a combination of horizontal and vertical lines, which can be manipulated using the selection tool.

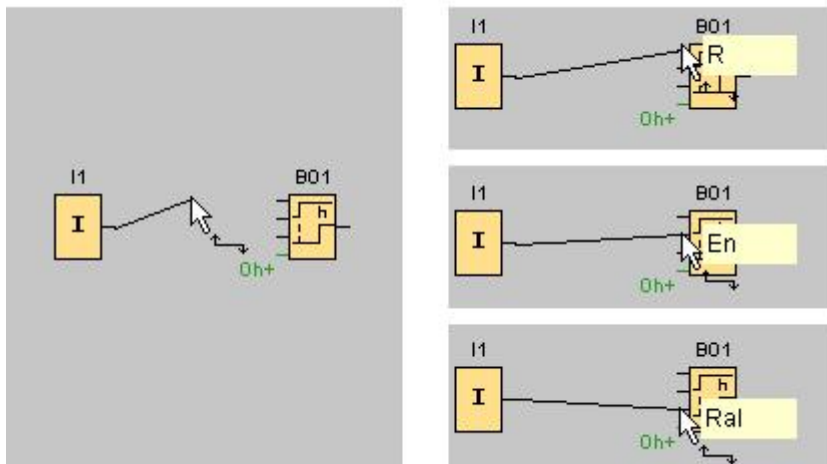

Fig. 7.10.4

FLC Logic Soft offers you a further option of connecting blocks when you right-click on the input or output of a block. In the shortcut menu, click the **Connect with block** menu command. This calls a selection list that contains all blocks available for your connection. Click on the relevant target block. FLC Logic Soft Comfort then draws the connecting line. This method is especially useful for connecting a source to a target block over a greater distance on the programming interface.

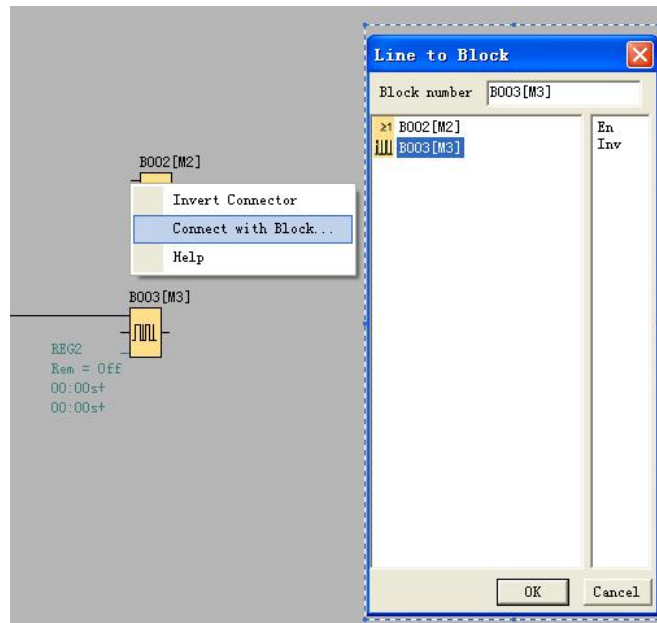

Fig. 7.10.5

Tips on connecting blocks

1. Move the mouse pointer over a block and briefly hold it in this position. The name of the block is shown. The name of the block input appears when you move the mouse pointer onto the input.
2. To make it easier for you to interconnect blocks, a blue frame around the mouse pointer pops when it is "captured" by a pin.

Rules for connecting blocks

The following rules apply to the connection of blocks:

1. You can connect a single input to multiple outputs.
2. You cannot connect multiple inputs to a single output.

You cannot interconnect I/O in the same path of a circuit program. Recursion is not permitted. Interconnect a flag or output if necessary.

Special function blocks also have green "connectors". These do not represent connecting pins, but are used instead for assigning the parameter settings.

Analog I/O cannot be connected to digital I/O.

5.9.2.4 Delete Function Block or Delete Link

When you put some needless block in program interface or link some default ones, you need to delete them as follows:

1. Pitch on module or link to delete with mouse.
2. Press "Delete" in the keyboard, or click right button of the mouse, select option "Delete" in the menu, then you can delete the module or link.

5.9.2.5 Change block index

In a program cycle, the block with little number will be run before the block with big number. For example, The below program, the run sequence is B001, B002, B003, the Q1 cannot get high.

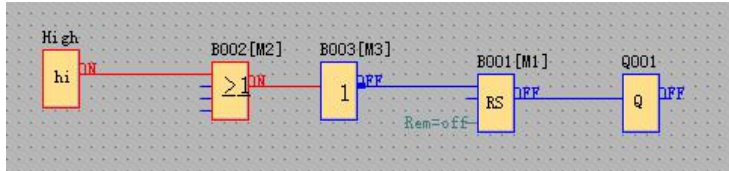

If I change the B002 to B004, the Q1 will get high in first. The program run sequence is B001, B003, B004.

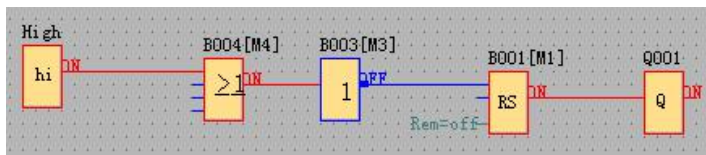

You can change the block number with clicking the block by right key and select the "change block index" option, then change to other block number.

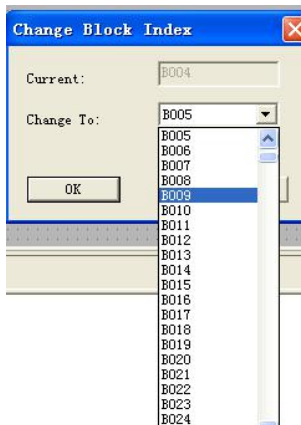
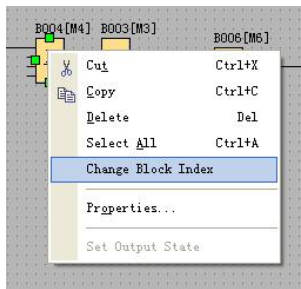

5.10 Simulation Running

FLC Logic Soft could edit function diagram, and perform function of simulation operation. After you finish the edit, you can start the function of simulation operation, to examine program to see if it performs your control logic or not.

Operation Method:

1. Click "Simulation" under the menu "Tools" with left button of the mouse . It's time to start program of simulation, or click "  " in the simulation toolbar with mouse, and it also can open simulation operation interface. It shows as Fig. 11.9.

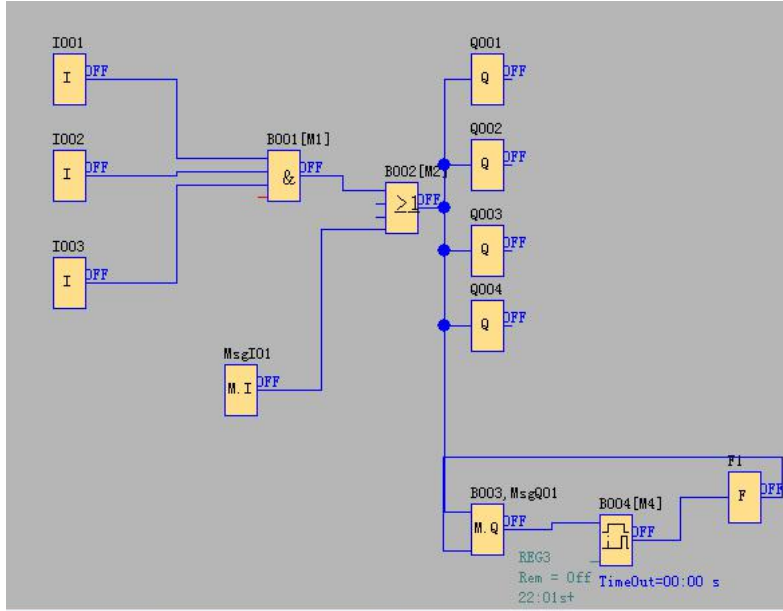



Fig. 7.10.6 Start simulation

2. Click input block with mouse. It can change the state of input, state displays "ON" and "OFF" in the output point of the module, so you can observe the state of input or output.



3. Click  button again, to terminate the operation function of the module.

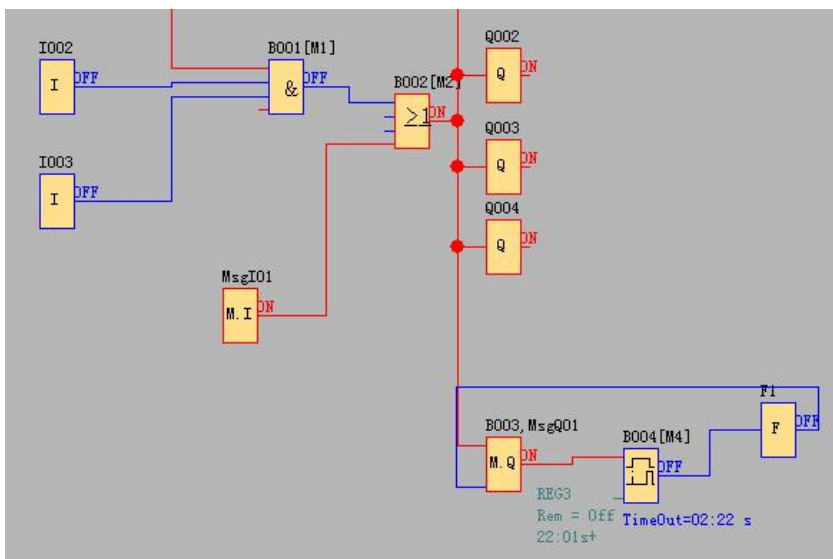



Fig. 7.10.7 Simulation Operation

Attn: In above graph, you can see "ON" or "OFF" state of input and output, and the output state and the current state of timing and counting of all blocks. Through this simulation operation graph, you can exam the program to see if it performs control requirement or not.

5.11 Save and Print

Operation method of file saving

- 1.To save a Program, click option "save" or "Save As" under menu "File" with left button of the mouse, as shown in Fig.7.10.8, or click button " "under toolbar.
2. You can set up saving path and file name in this box.
3. After the setup of the file saving path and file name, click "save" to save file in the appointed path, then complete to save file.

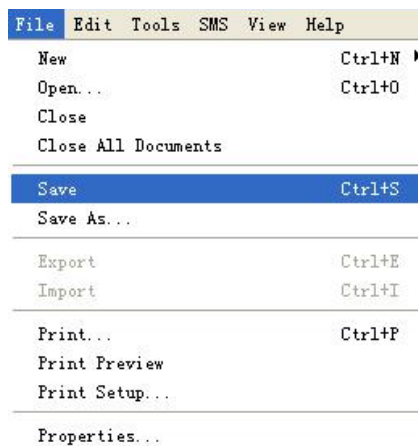

Fig. 7.10.8 Save File Menu

Operation Method of Printing File

1. Click option "Print" under menu "File" with left button of mouse.
2. Dialog box as shown in Fig. 7.10.9 appears, set up your printing requirement according to the cue of dialog box.
3. Click "confirm" with left button of mouse, then your file will be printed in your printer.

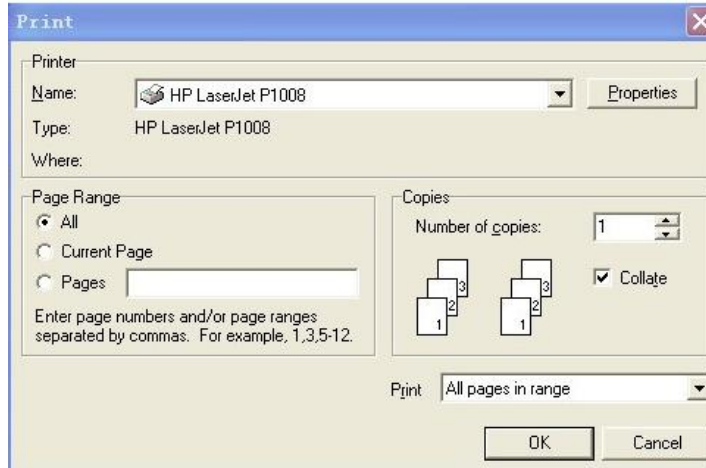



Fig. 7.10.9 File Print

5.12 Modify Password and transfer the Program

Operation Method:

a. First of all, link FLC with your PC through the optional way: RS232 cable, USB cable (need install driver first).

b. Open application software FLC Logic Soft, set up a new document, then open computer com. Click option

“Configuration” under menu “Tools” with left button of the mouse, or click  “in toolbar, dialog box shown as 7.10.10 appears, then select your communication port and speed.

Option A. RS232. This option is used when you use the FLC-RS232 or FLC-USB (relative driver needed) cable.

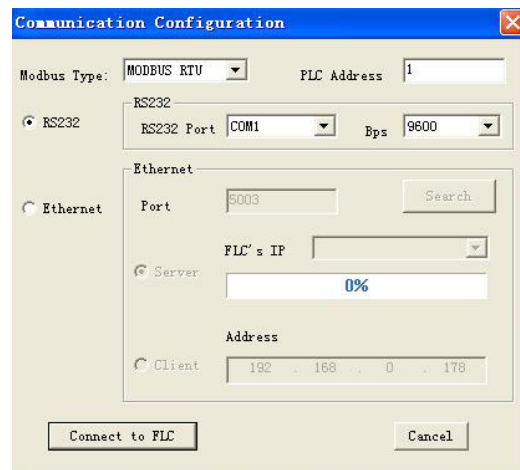

Fig. 7.10.10 Set Up Port and Baud Rate

1. Setup Password and Time

I. FLC permits you to set up password for your Program. Only after input of right password, you can write, read and modify your Program.

Operation method of setup password

a. Click "File->Property" and select "parameter" option, then you can input the password into the dialog box shown as Fig.7.10.11 appears:

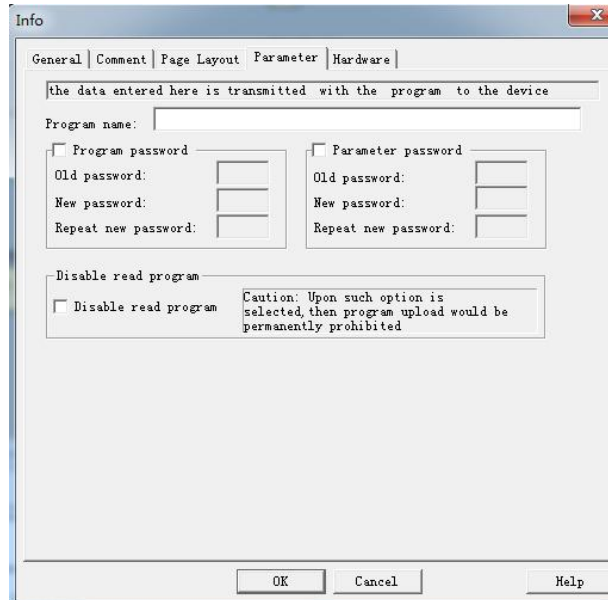



Fig. 7.10.11 Set or modify program password

Program password and parameter password can be set here, and you can directly set the parameter password by the panel on the CPU "Set.."->" Password"-> "Set password"

Operation Method:

c. Click option "Tools->transfer->Set time" with left button of the mouse, or click "  under toolbar, dialog box appears shown as Fig. 7.10.12.

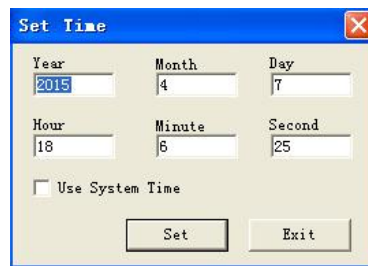

Fig. 7.10.12 Modify Time Interface

d. Display system time in this dialog box, click "  ", cue shown as Fig. 7.10.13 appears, to renew time of FLC succeed.

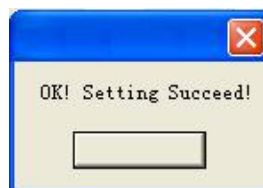



Fig. 7.10.13 Setup Time Succeed

2. Download/Upload Function Block Program

After you debug the function graph successfully, you need to download it into FLC (FLogic), and operate as following process.

Operation Method of read-in Program

a. First of all, connect FLC with your PC through the optional way: RS232 cable, USB cable (need install driver first).

b. Open FLC Logic Soft, create a new program, then open computer com port by click then menu Tools-> configuration with left button of the mouse, or click " "in toolbar.

c. Click option "transfer -> PC -> FLC" under menu "Tools"; or click button " "in toolbar



d. Click button " " with left button of mouse, start update Program, downloading status shown as Fig. 7.10.14 display update Program course.



Fig. 7.10.14 downloading status

Note: After the Program updated, FLC will run the Program automatically, do not need restart.

Operation Method of Upload Program:

a. Click option "Transfer -> FLC -> PC" under menu "Tools" with left button of mouse, or click " "under toolbar.

b. Click button " " with left button of mouse, start upload Program, uploading status shown as Fig. 7.10.14 display upload Program course.

5.13 On-line monitoring/test circuit program

After you are satisfied with your program simulation and have downloaded it to FLC CPU, you can also perform an online test of the circuit program. An online test is similar to simulation in that you can view inputs and outputs and block parameters. It differs, however, in that you are testing the program running in the FLC with "live" inputs rather than testing the program on the PC with simulated inputs. Multiple registers can be accessed individually by clicking "Tools->Set Monitor Config".

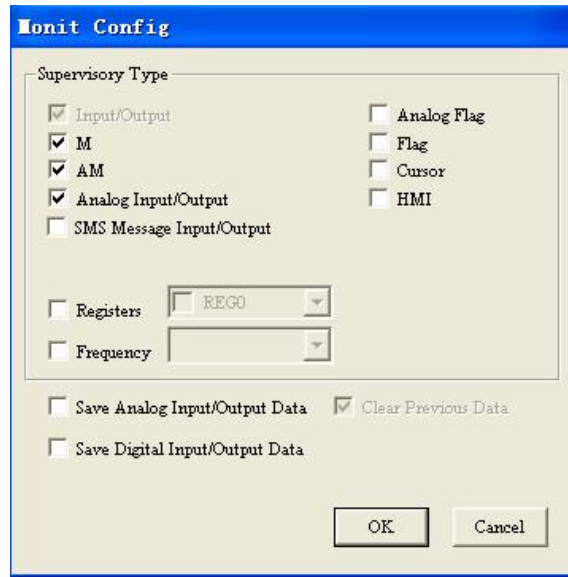

Monitor mode:

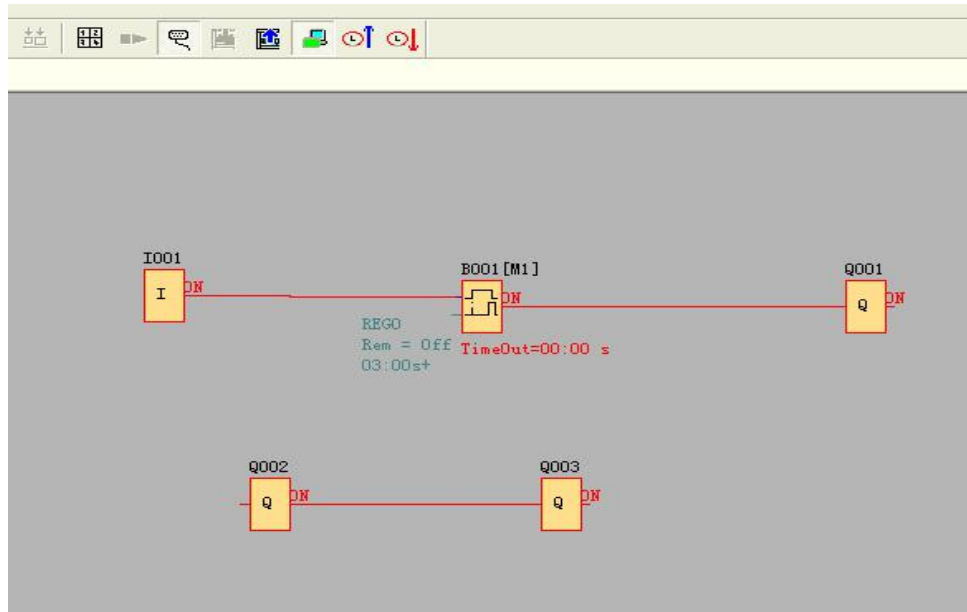

Under monitor mode, user can change the spare output (the input pin of Q is not connected to other blocks) state via FLC Logic Soft.

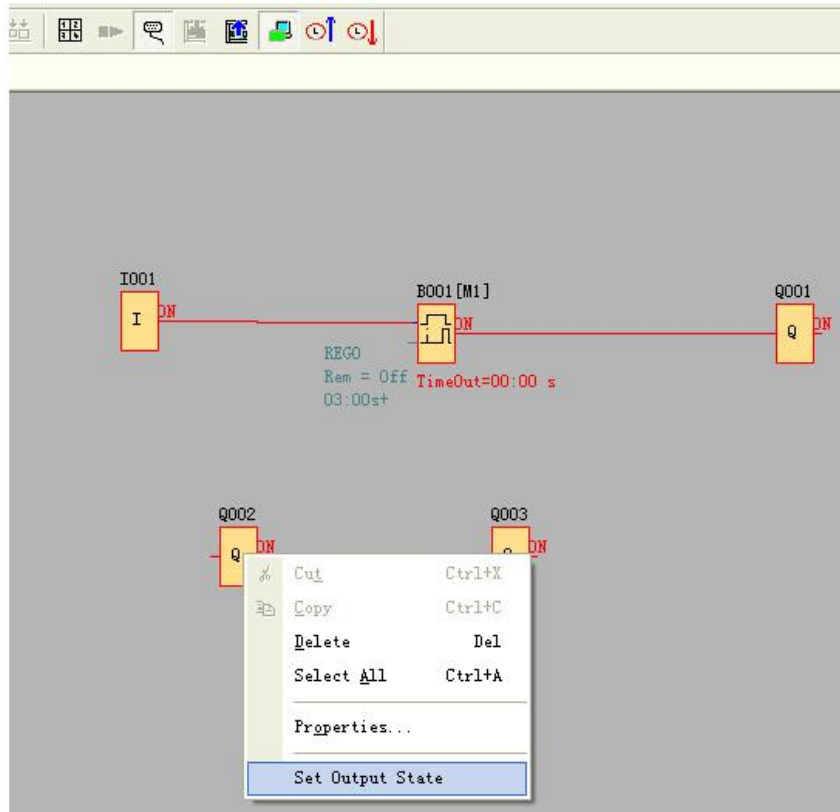

Right click "Q2" and then click "Set Output State".

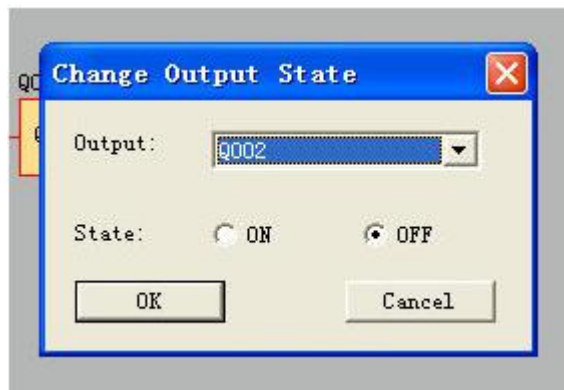

Click "OK" button and the Q2 of FLC will be turned off.

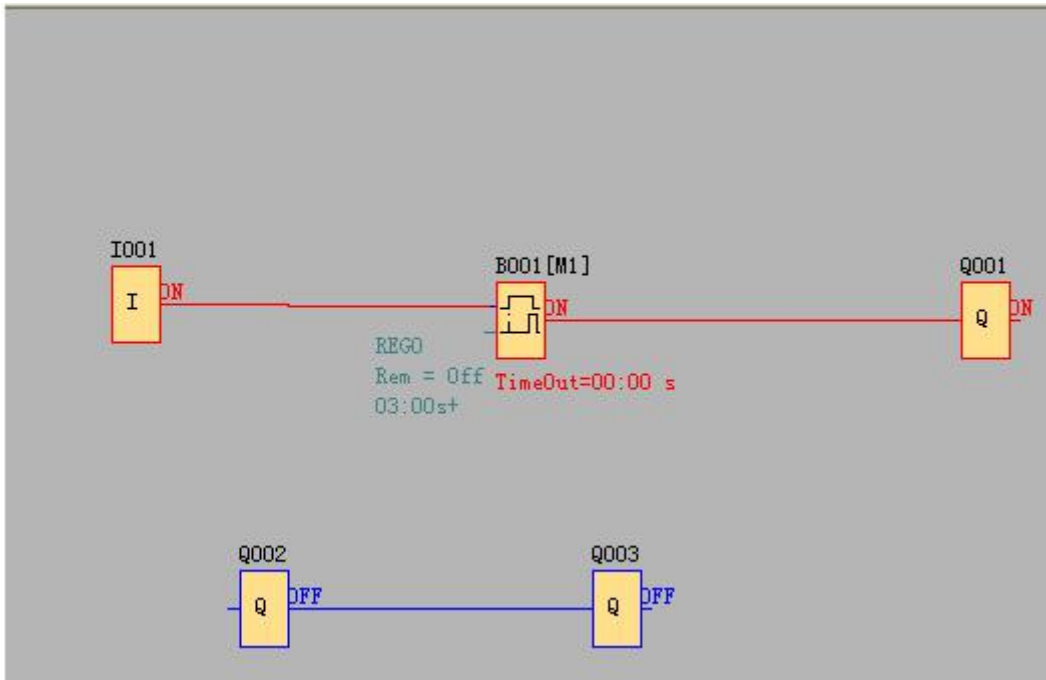

How to transfer monitoring data (AI/AQ) to an Excel file ?

Example program:

1. Select Tools-> Set Monit Config and further click it.

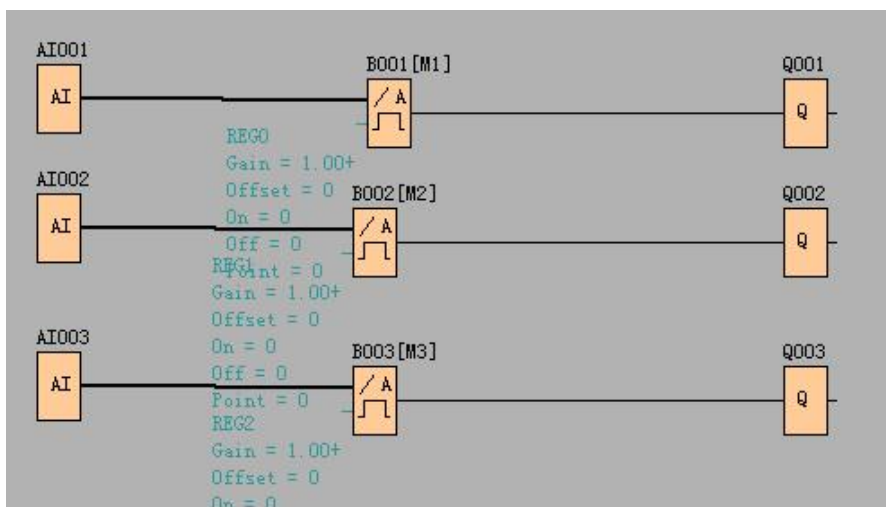
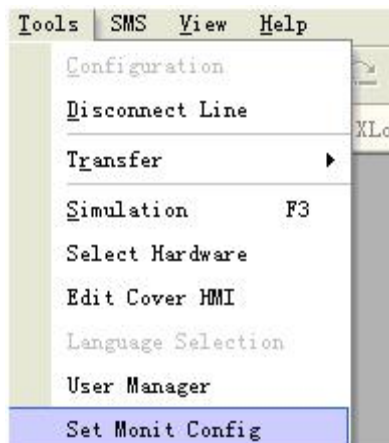

As below configuration shows, all history data of AI/AQ under monitor mode can be automatically saved to one EXCEL file for user's reference.

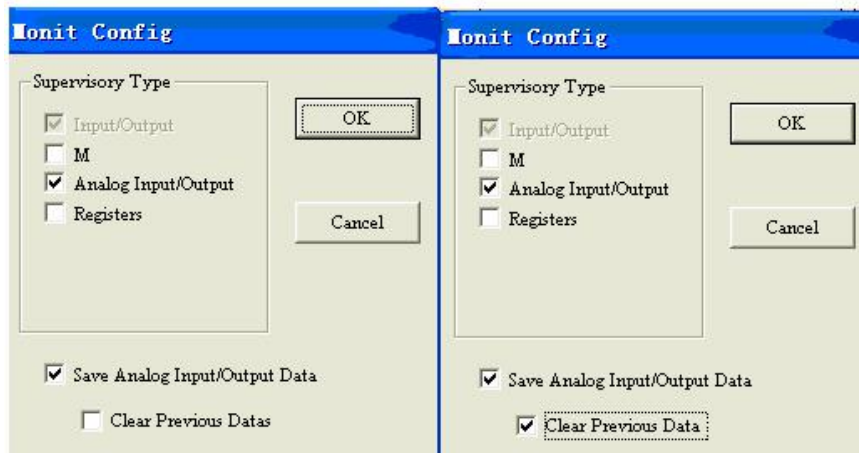

Caution: If the "clear previous data" is selected as well, then the history data cannot be saved, and then only the current monitor data can be saved, furthermore, the history data (previous monitor data) would be simultaneously cleared.

2. Click here to enter Monitor Mode

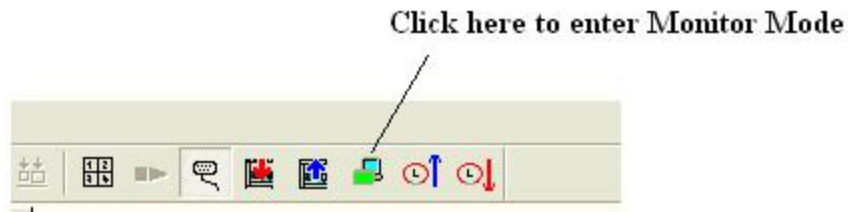

3. View the data by clicking View-> Monit data.

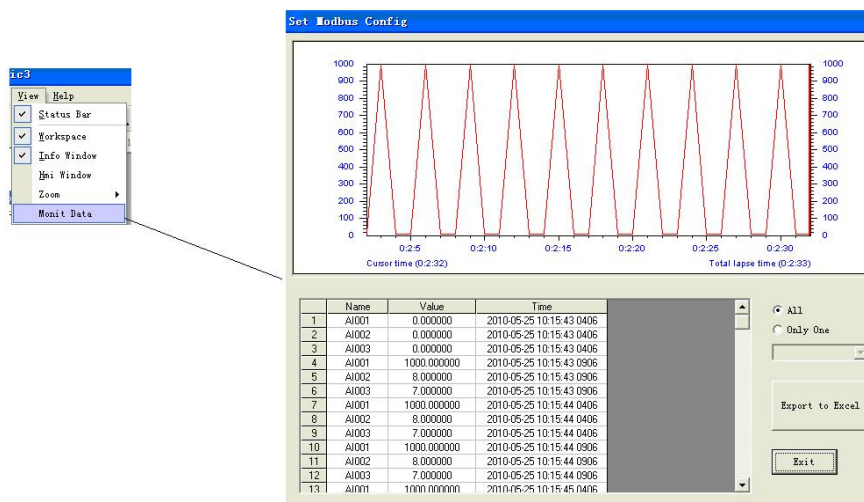

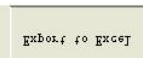
4. Click  to transfer data into one Excel file (it contains AI1/AQ number, value and the corresponding time.).

Programmable Relay User's Manual FLC12 & FLC18

	A	B	C	D	E	F	G
1	Value_Inc	IO_Name	IO_Value	Value_Time			
2	1	AI001	0	2010-05-25 10:00:34	0234		
3	2	AI002	0	2010-05-25 10:00:34	0234		
4	3	AI003	0	2010-05-25 10:00:34	0234		
5	4	AI001	1000	2010-05-25 10:00:34	0734		
6	5	AI002	7	2010-05-25 10:00:34	0734		
7	6	AI003	6	2010-05-25 10:00:34	0734		
8	7	AI001	1000	2010-05-25 10:00:35	0234		
9	8	AI002	7	2010-05-25 10:00:35	0234		
10	9	AI003	6	2010-05-25 10:00:35	0234		
11	10	AI001	1000	2010-05-25 10:00:35	0734		
12	11	AI002	7	2010-05-25 10:00:35	0734		
13	12	AI003	6	2010-05-25 10:00:35	0734		
14	13	AI001	1000	2010-05-25 10:00:36	0234		
15	14	AI002	7	2010-05-25 10:00:36	0234		
16	15	AI003	6	2010-05-25 10:00:36	0234		
17	16	AI001	1000	2010-05-25 10:00:36	0734		
18	17	AI002	7	2010-05-25 10:00:36	0734		
19	18	AI003	6	2010-05-25 10:00:36	0734		
20	19	AI001	1000	2010-05-25 10:00:37	0234		
21	20	AI002	7	2010-05-25 10:00:37	0234		
22	21	AI003	6	2010-05-25 10:00:37	0234		
23	22	AI001	1000	2010-05-25 10:00:37	0734		
24	23	AI002	7	2010-05-25 10:00:37	0734		
25	24	AI003	6	2010-05-25 10:00:37	0734		
26	25	AI001	1000	2010-05-25 10:00:38	0234		
27	26	AI002	7	2010-05-25 10:00:38	0234		
28	27	AI003	6	2010-05-25 10:00:38	0234		
29	28	AI001	1000	2010-05-25 10:00:38	0734		
30	29	AI002	7	2010-05-25 10:00:38	0734		
31	30	AI003	6	2010-05-25 10:00:38	0734		
32	31	AI001	1000	2010-05-25 10:00:39	0234		
33	32	AI002	7	2010-05-25 10:00:39	0234		
34	33	AI003	6	2010-05-25 10:00:39	0234		
35	34	AI001	1000	2010-05-25 10:00:39	0734		
36	35	AI002	7	2010-05-25 10:00:39	0734		
37	36	AI003	6	2010-05-25 10:00:39	0734		
38							

Chapter 6 Applications

In order to let users know the far going application field of FLC, we present a set of application example. Each instance includes the circuit program of its original solution and the compare of solution in which FLC has been applied.

You can find the following solution:

Dual-function switch

Automatic gate

Ventilation system

Industry door

Daylight lamps

Rain water pump

Note:

The application example of FLC is available free of charge to our clients, but we can't make any promise, it is only to explain the general rule of using FLC. It is possible that these instances can be different from user's specific application, so user should take all related responsibility of running those instance systems, and we sincerely suggest user shall refer to relevant nation standard and installation rules related to systems. Also, we have to point out that error is unavoidable, and we reserve the according modification rights.

6.1 Dual-function switch

Requirements for stairway lighting systems

The basic requirements for a stairway lighting system are as follows:

- When someone is using the stairs, the stairway lights should be on.
- If no one is in the stairway, the lights should go out in order to save energy.

6.1.1 Standard solution

Up to now two methods were known to control such a lighting system:

- Pulse relay: When the lights are off, press any of the pushbuttons to switch on the lights. When the lights are on, press any of the pushbuttons to switch off the lights again.

Disadvantage: People often forget to switch off the lights

- Automatic stairway light switch: Press any one of the pushbuttons to switch on the lights. The lights switch off again automatically when a preset off delay time has expired.

Disadvantage: You can't keep the lights switched on over an extended period of time. The permanent on switch, usually installed inside the stairway lighting timer unit, may be difficult or impossible to access.

The wiring is the same for both systems.

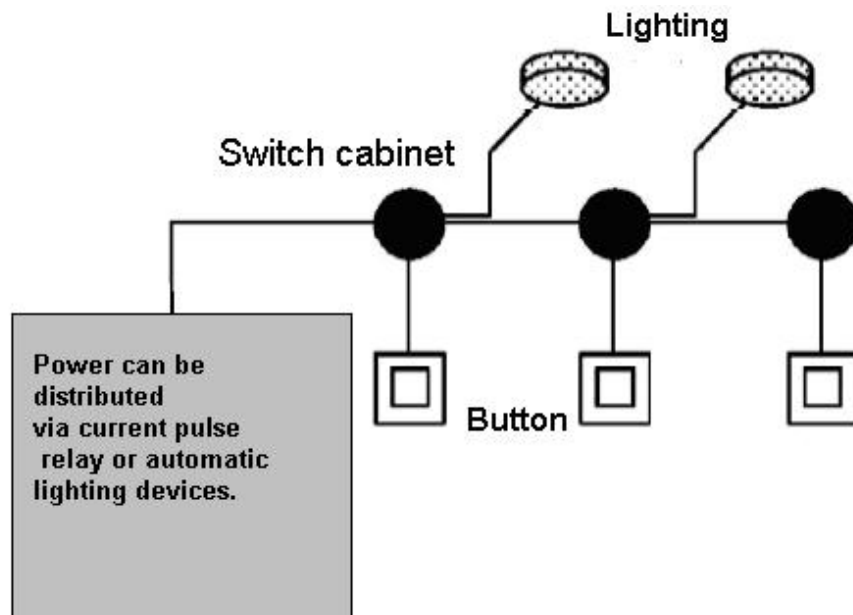

FLC Logic Soft solution

The FLC system can replace the automatic stairway light switch or the pulse relay.

FLC also lets you create a simple automatic stairway light switch via the stairway light switch SFB. You can also implement both functions (off delay timer and pulse relay in a single unit. What is more, you can incorporate extra functions without making any alterations to the wiring. In our example

program, we have combined the advantages of both the current impulse relay and the automatic stairway lighting timer as follows:

- Actuate the pushbutton → The light is switched on and switched off again on expiration of a predefined time.
- Hold the pushbutton down → Switches on continuous lighting
- Press the pushbutton once more → Switches off the lighting

6.1.2 The scheme of FLC

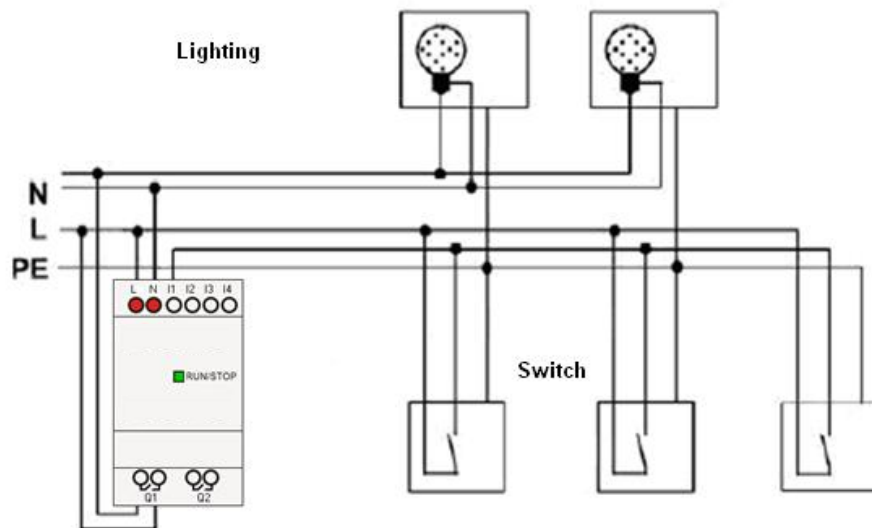

The wiring of a lighting system with FLC is the same as standard corridor or stairway lighting systems. Only the automatic lighting timer/pulse relay is replaced. FLC lets you quickly and easily combine all those functions in a single dual-function switch SFB, without additional wiring and expenditure.

Apply pulse relay of FLC

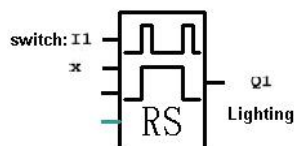

When the input "I1" has a pulse, the output "Q1" will be on or off.

Automatic stairway lighting system

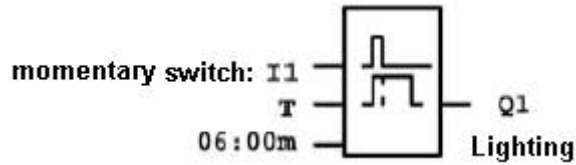

If input "I1" has a pulse, the output Q1 will be on and keep 6 minutes, then be off.

Apply FLC to realize multiple switches

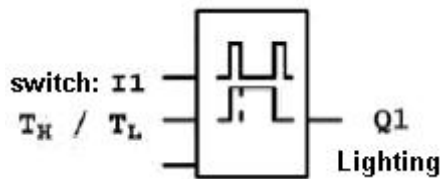

When the input "I1" has a pulse, the output "Q1" will be on and not off until the period "TH" be over. Keep the momentary switch holding down in period "TL", the light will be on all the time.

Select special function

The following selection can be done as special function or saving energy sources:

- The lighting flicker before it gets off automatically.
- You can integrate different central control functions:
- Central control off
- Central control on(emergency button)
- Control all lighting or certain single circuitry by lighting control switch
- To control by integrated timer.

6.2 Automatic gate

In the entrance of supermarket, public building, bank, hospital etc., automatic gate is often used.

The requirement of automatic gate

- If some people approach to gate, it will be opened automatically.
- The gate must remain open until there is no person on the passageway.
- If there is no person on the passageway, the gate must be off automatically in a minute.

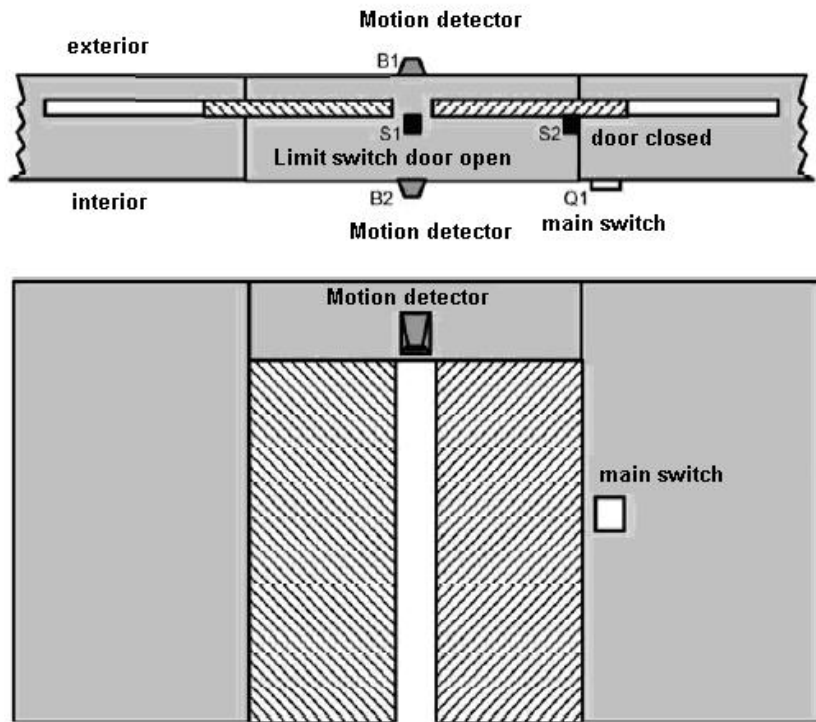

6.2.1 Standard solution

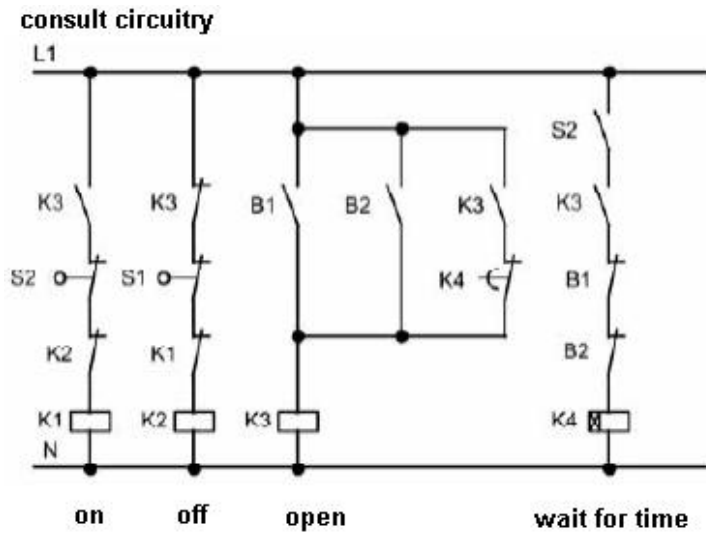

As long as the detector B1 or B2 detects someone approach, the switch K3 will be on and open the door. If the two detectors don't detect person in a short time, trigger K4 and close the door.

6.2.2 The scheme of FLC

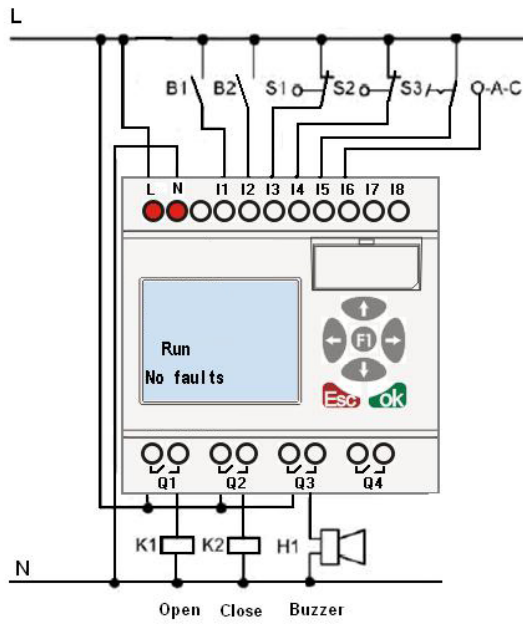

Required components:

- K1 open contactor
- K2 close contactor
- S1 (break contact) close limit switch
- S2 (break contact) open limit switch
- B1 (make contact) outdoor infrared action detector
- B2 (make contact) infrared action detector inside

FLC function block circuit program:

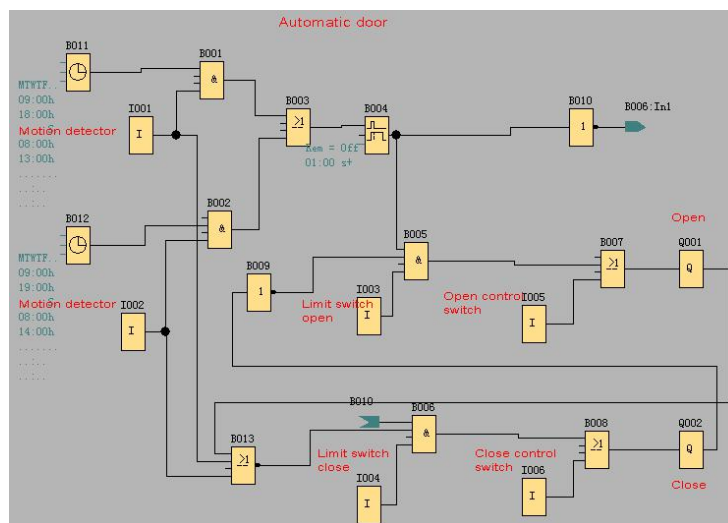

Motion detector

During business hours, if someone enters store, the detector B1 will trigger electric motor to open the door, vice versa.

At closing time, the detector B2 make electromotor keep running for an hour to make more time for customer to leave.

Trigger electromotor for opening door

The output Q1 is switched on and triggers electromotor, when:

- Operate control switch I5 (the door is open all the time)
- The detector indicates that somebody is approaching to the door.
- The door has not been opened entirely (I4 limit switch is not off).

Trigger electromotor for closing door

- Operate control switch I6 (the door is closed all the time)
- The detector indicates that nobody is approaching the door.
- The door had not been closed entirely (I3 limit switch is not off).

Buzzer

Connect the buzzer to output Q3. When the door is going to be closed; the buzzer gives off sounds for a short time (1s in this example). To attach buzzer, need to connect the following circuit program to output Q3.

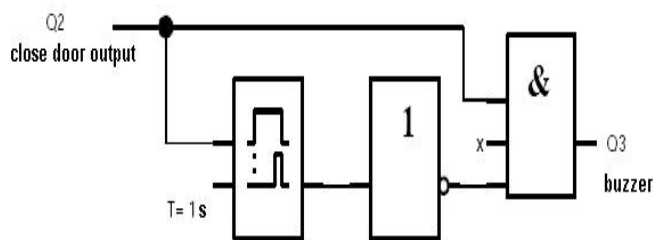

6.3 Ventilation system

Requirements for a Ventilation system

A Ventilation system supplies fresh air into a room and exhausts the contaminated air. Let us look at the following sample system:

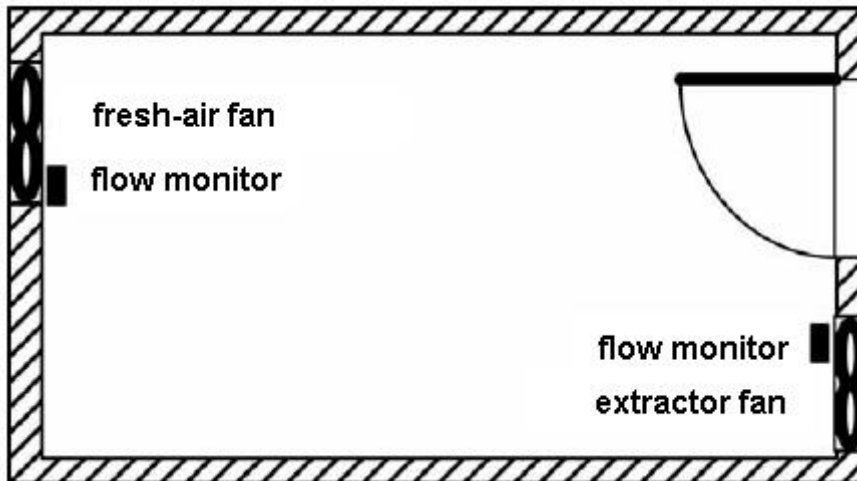

- A room contains an extractor fan and a fresh-air fan.
- Each fan is monitored by means of a flow sensor.
- The pressure in the room may rise above the atmospheric pressure.
- The fresh-air fan may only be switched on if the flow sensor signals the safe operational state of the extractor fan.
- A warning lamp indicates failure of one of the fans.

6.3.1 Standard solution

The control circuit diagram of Ventilation system formerly as follows:

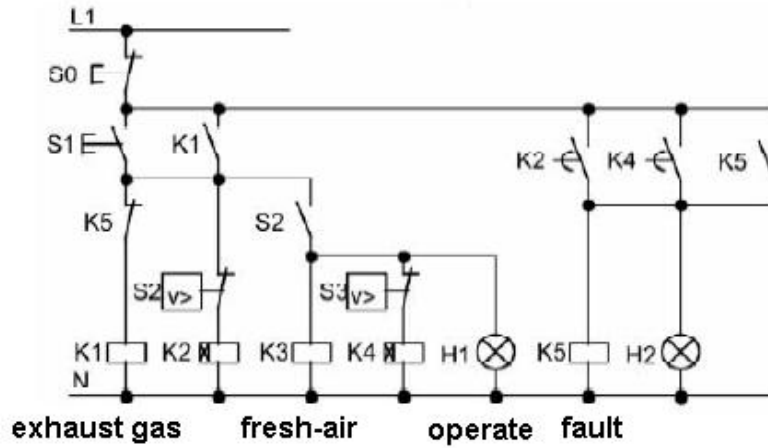

The fans are monitored by means of flow sensors. If no air flow is registered after a short delay time has expired, the system is switched off and an error message is generated, which can be acknowledged by pressing the off button.

Fan monitoring requires an analyzer circuit with several switching devices, in addition to the flow sensors. A single FLC device can replace this analyzer circuit.

6.3.2 The scheme of FLC

The circuit diagram of ventilation system:

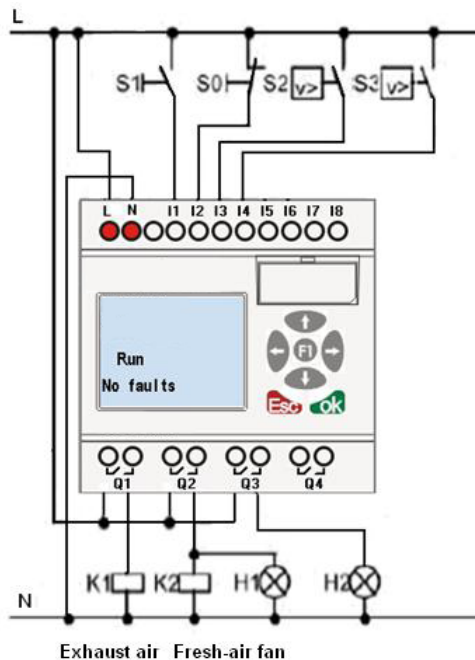

Required components:

- K1 Main contactor

- K2 Main contactor
- S0 (make contact) Off button
- S1 (make contact) On button
- S2 (break contact) Flow monitor
- S3 (break contact) Flow monitor

- H1 Flashing lamp
- H2 Flashing lamp

FLC Logic Soft solution

The use of FLC reduces the amount of switchgear. Thus, you save installation time and space in the control cabinet. You may even be able to use as a smaller control cabinet.

With FLC you can also switch off of the fans sequentially after the system is switched off.

The circuit in FLC Logic Soft

The system is switched on and off at the inputs I1 and I2. The fans are connected to outputs Q1 and Q2, the flow sensors are connected to the inputs I3 and I4. Blocks B07 and B10 are used to set the watchdog times after which the flow sensors should send a signal to the fault output Q3.

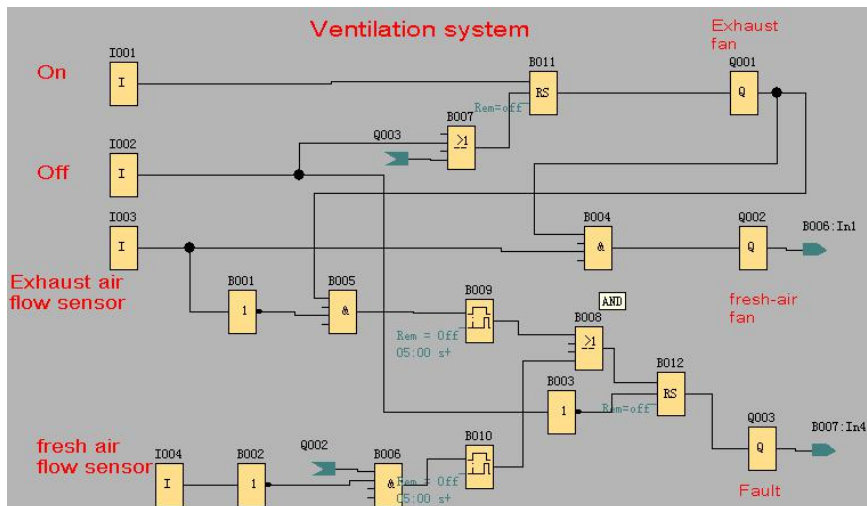

You can invert output Q3 to use output messages at Q4. Relay Q4 only drops out if main power is lost or if there is a fault in the system. The output can then be used for a remote message.

6.4 Factory door

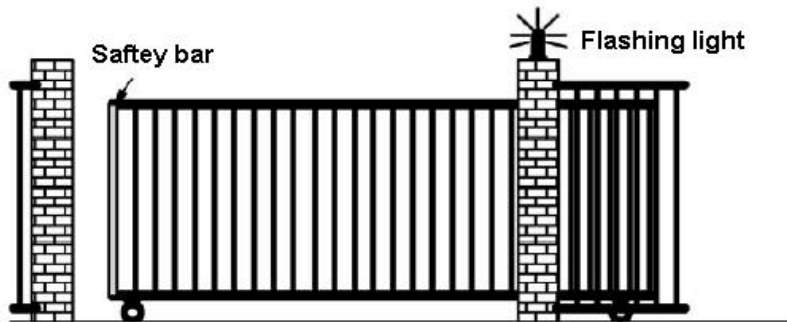

Requirements for a gate control system

In many cases a factory entrance is closed with roll gates. Those gates are only opened when vehicles need to enter or leave the factory grounds. The gate is controlled by the porter.

- The sliding gate is opened and closed by means of a pushbutton control in the gatehouse. The porter can monitor the gate operation.
- The roll gate is normally fully opened or it is closed. However, gate movements can always be interrupted.
- A flashing light is activated five seconds before the gate moves, and while the gate is in motion.
- A safety pressure strip ensures that people are not injured and that no objects are trapped and damaged when the gate is closing.

6.4.1 Standard solution

There are many different control systems for operating automatic gates. The OPEN and CLOSE buttons initiate gate movements into the relevant direction, provided it is not already moving in the opposite direction. Movement of the gate is terminated either by means of the STOP button or the relevant limit switch.

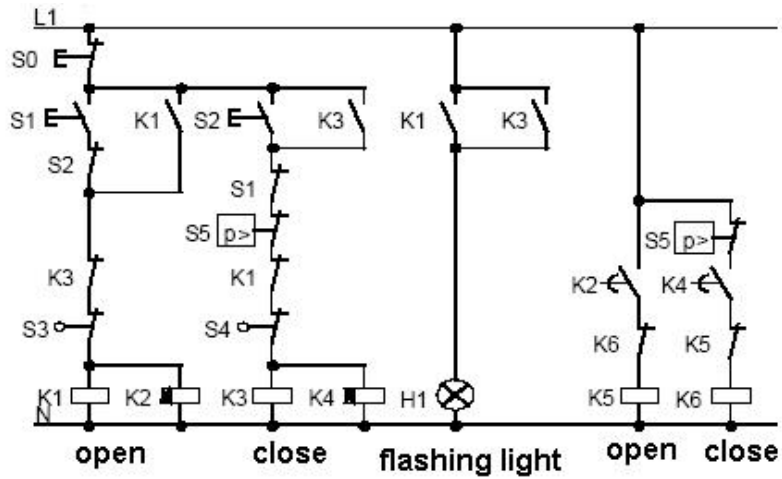

6.4.2 The scheme of FLC

The circuit diagram of industry gate:

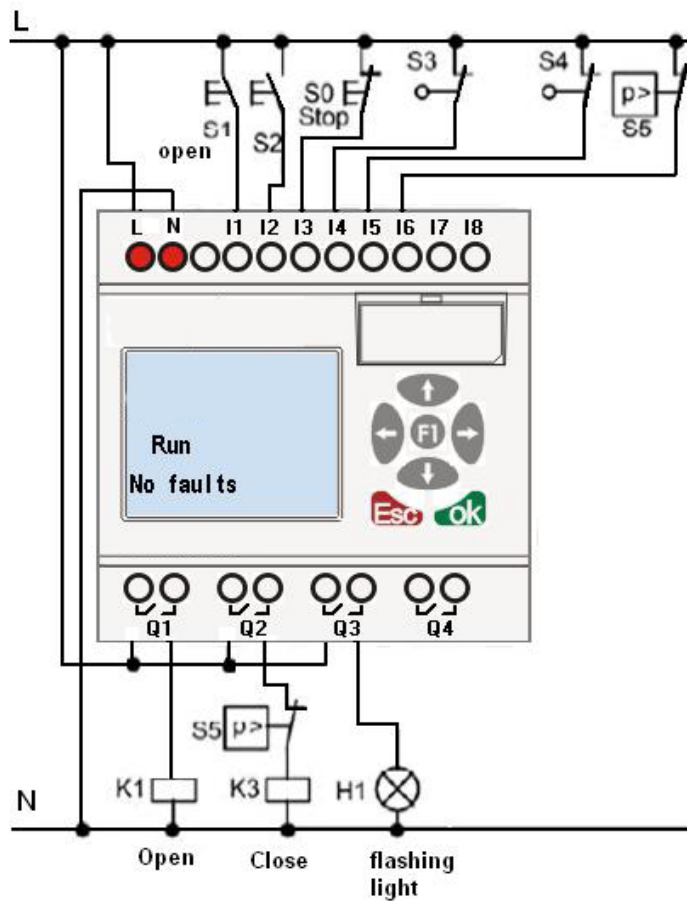

Required components:

- K1 Main contactor
- K2 Main contactor
- S0 (break contact) Off button
- S1 (make contact) Open button
- S2 (make contact) Shutdown button
- S3 (break contact) Open position sensor
- S4 (break contact) Shutdown position sensor
- S5 (break contact) Safety bar

FLC Logic Soft solution

A FLC circuit provides a further feature compared to standard controls: The actuation of a safety bar interrupts the closing motion of the gate. Five seconds before the gate is opens or closes, a flashing light

is activated and signals the start of the movement. It continues flashing until the gate has stopped.

In contrast to standard solutions, FLC offers an F&F and economic means of modifying the control system.

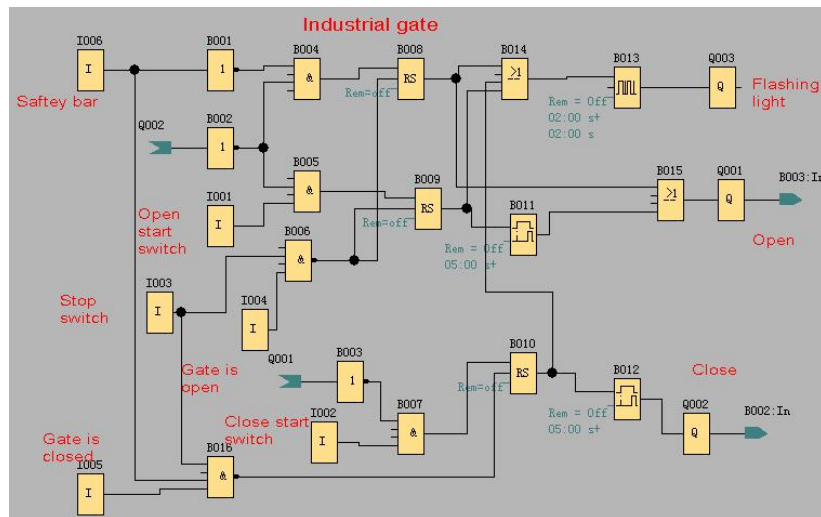

6.5 Daylight lamp system

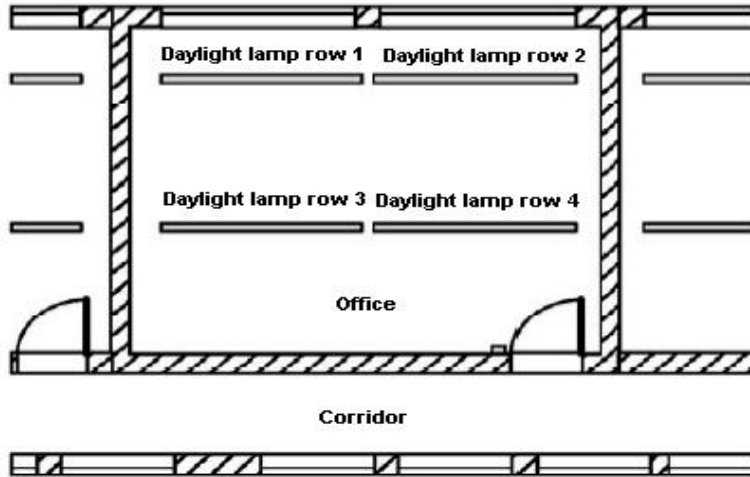

Requirements for lighting system:

- Different daylight lamp rows should be able to be switched on and off handily.
- If window at one side has enough light, the light will be switched off automatically via lightness sensitivity switch.
- The light would be switched off automatically at 8:00 p.m.
- The light can be switched on and off manually at any time.

6.5.1 Standard solution

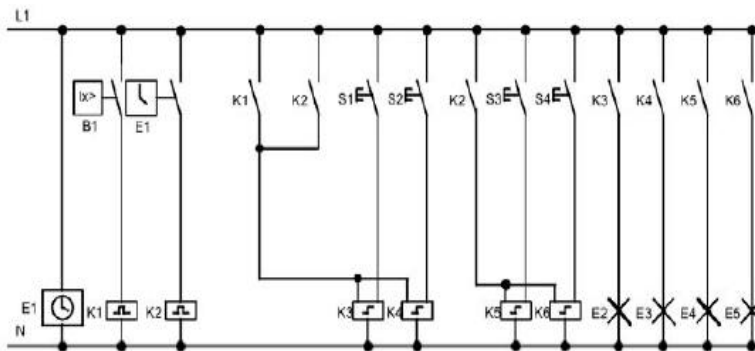

Lighting lamp can be operated by pulse relay controlled by button besides the door. Pulse relay can be repositioned by means of timer and lightness sensitivity switch. Pulse relay may shorten pulse width of "off command".

Required component:

- Button S1-S4
- Daylight control switch B1
- Timer T1
- Pulse relay K1 and K2
- pulse switch K3-K6 able to be switched off collectively

Disadvantages of traditional solution:

- In order to realize function, it needs plenty of wiring.
- Vast mechanical parts will result in obvious abrasion and high maintenance costs.
- Modification function can cause much work.

6.5.2 The scheme of FLC

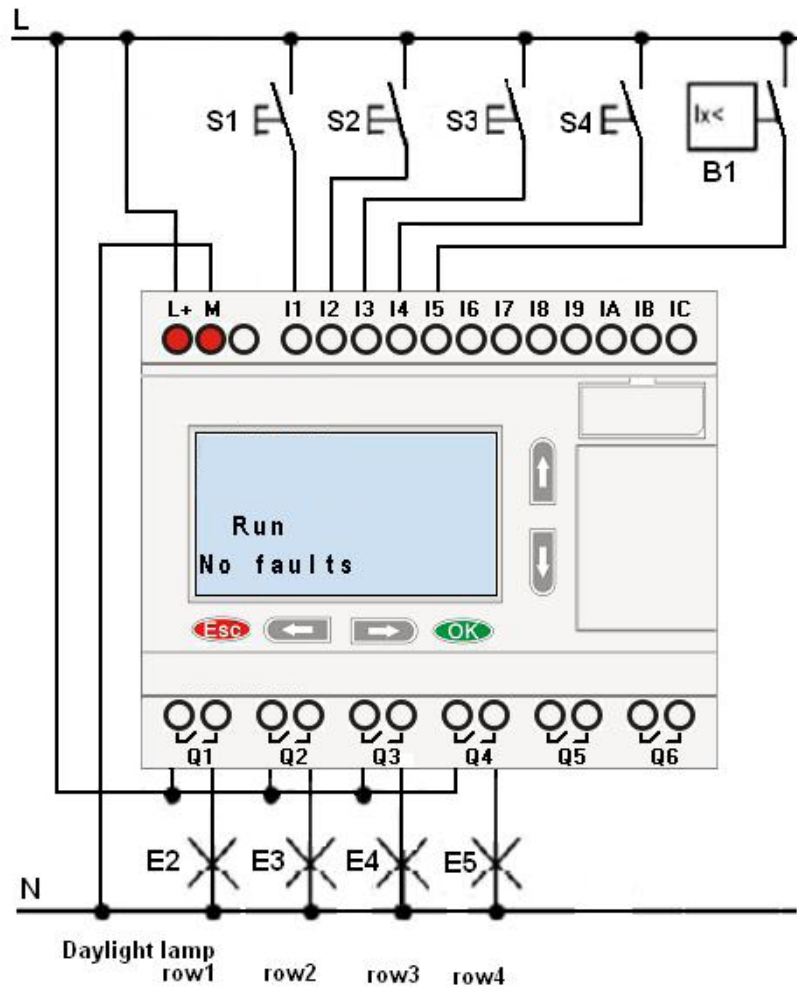

Components:

- S1—S4 (make contact) Momentary switch
- B1 (make contact) Daylight control switch

Circuit diagram by FLC Logic Soft:

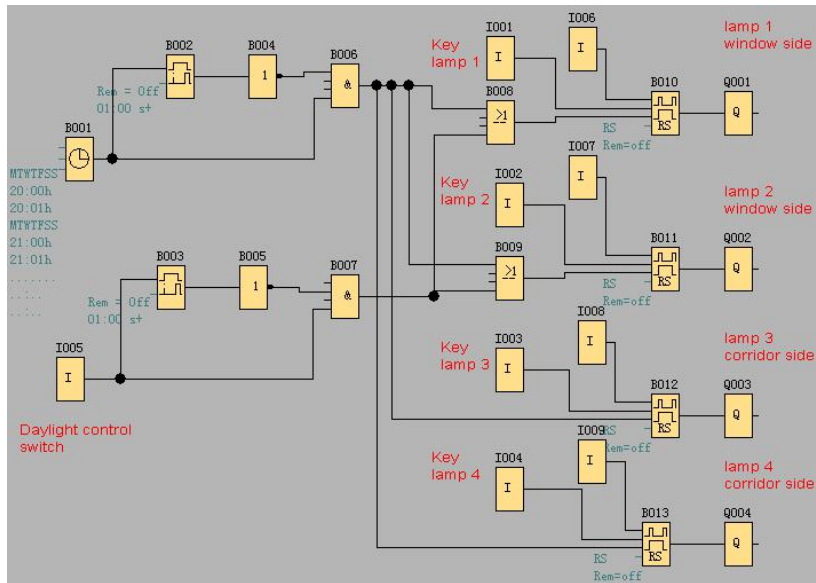

Benefits:

While power consumption of load does not exceed output of switch's voltage range, lamp can be directly connected to FLC main module; however, if power consumption of load exceeds output of switch's voltage range, then power contactor would be required.

- You can connect directly lightness sensitivity switch to the input of FLC.
 - Don't need external timer, as this function has been integrated in FLC.
 - It can be installed in a small-sized cabinet, so quite space-saving.
 - Less equipment
 - Quite easier to modify lighting system
- According to your demand, you may setup supplementary on/off timing (lamp can be switched off in

order at the end of day.

Easier to apply role of lightness sensitivity switch to lamp or already modified lamp row.

6.6 Rainwater pump

Nowadays besides drinkable water in family, rainwater applications is gradually increasing. In this way much costs can be saved, also environment can be improved as well. The application of rain water as follows:

- Wash clothes
- Water system in garden
- Potted plant water
- Wash car
- Scour W.C.

The following figure is to tell you how to run the rainwater application system:

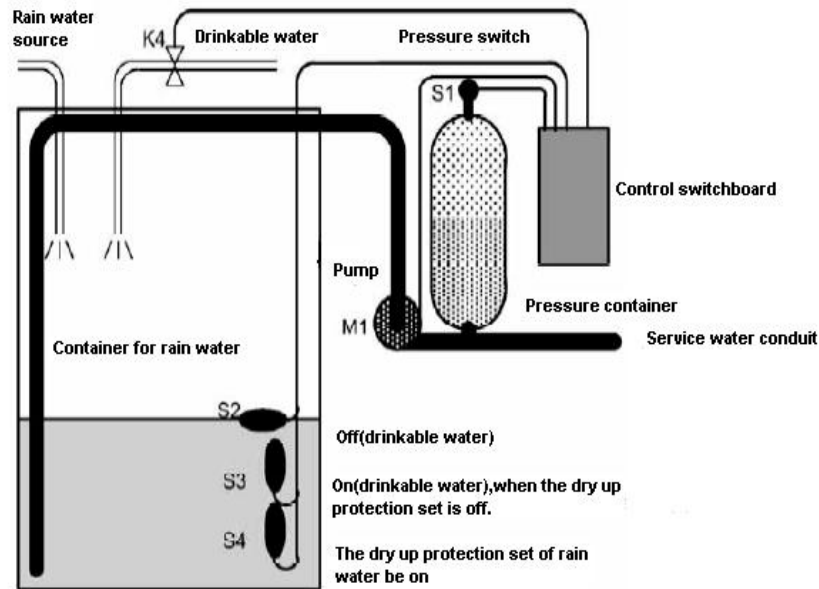

The rain water is collected in the container and then pumped to service water ductwork through pumping station. So you can apply rain water as drinkable water. If the rain water in the container dried up, this system can supply drinkable water.

Requirements for the control system of service water pump

- It can provide service water all day, under the contingency instance, the control system must be able to be switched over to drinkable water system automatically.
- When switching to drinkable water system, it can't interlard rain water.
- If rain container has not enough rain water, service water pump can't be on (rain water dry-up protection).

6.6.1 Standard solution

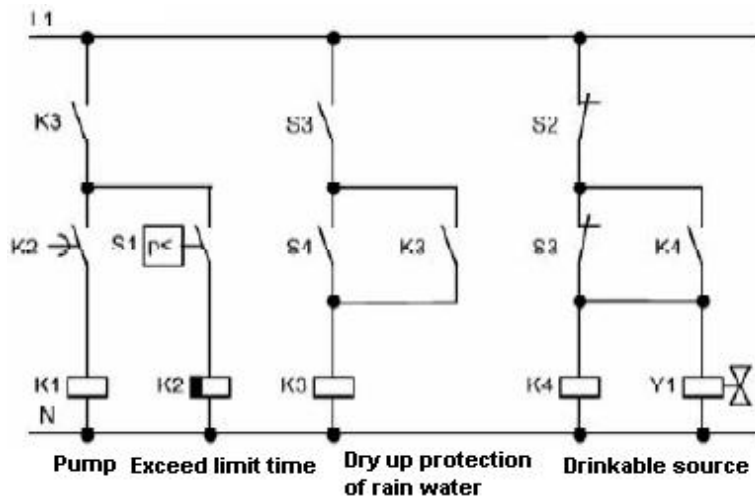

6.6.2 The scheme of FLC

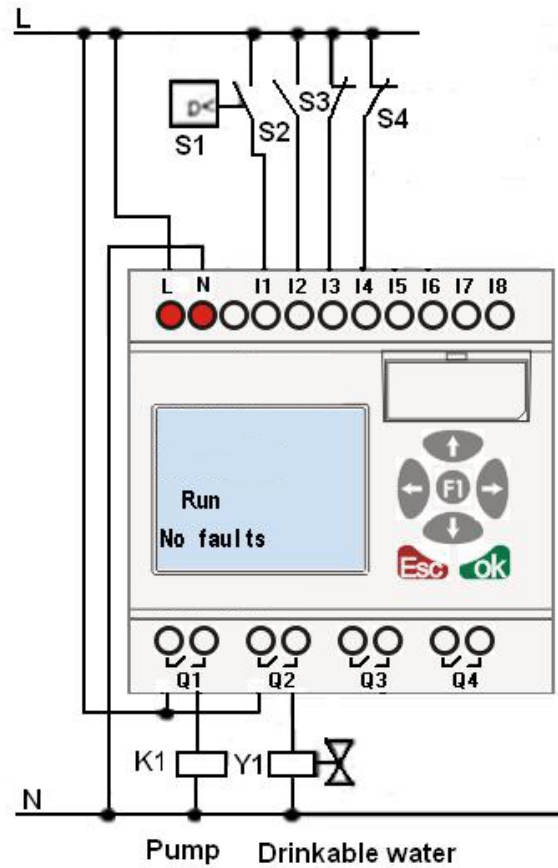

Chapter 7 Modbus function code and Register addresses

7.1 FLC modbus function code

The following table contains some communication orders supported by FLC.

Order code(Hex)	Function description	Length of message(one frame order can deal with)	Remarks
01	Read one group coil status (00000 ~ 0XXXX)	--	Read Coil Status (Output relay)
02	Fetch one group data of the status of switch input (10000~1XXXX)	--	Read input Status (input relay)
03	Read data of multi-holding register (40000~4XXXX)	--	Read Holding Registers (Output register)
05	Force the switch status of single coil (00000~0XXXX)	1	Force Single Coil
06	Pre-set the data of single register (40000~4XXXX)	80	Set single output register
15	Force multi-coils on/off data (00000~0XXXX)	many	
16	Write multi-holding registers data (40000~4XXXX)		

7.2 Register addresses of FLC



Communication parameters settings:

PLC mode selection: MODBUS RTU Communication parameter set:

Baud rates: 9600

Data bit: 8

Stop bit: 1

Name	Set address method (DECIMAL)	Data format	Attribute
<p>Digital input</p> <p>Block in FLC Logic Soft:</p>  <p>MODBUS code: 02</p>	<p>FLC12:0~7</p> <p>FLC18 (CPU):0~11 FLC18E (EXT1):12~19 FLC18E (EXT2):20~27 FLC18E (EXT3):28~35</p> <p>FLC18E (EXT9):76~83 FLC18E (EXT10):84~91</p> <p>FLC18E (EXT15):124~131 FLC18E (EXT16):132~139</p>	<p>BIT</p>	<p>R</p>
<p>4 cursors (Cursor key)</p>  <p>Type:(1x) MODBUS code: 02</p>	<p>C1-C4: 256~259</p>	<p>BIT</p>	<p>R</p>

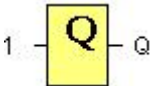
Digital outputs		BIT	R/W
			
(0x)			
MODBUS code:	FLC12 (CPU):0~3		
01(read)			
05	FLC18E (CPU):0~5		
(single Write)	FLC18E (EXT1):8~15		
	FLC18E (EXT2):16~23		
15	FLC18E (EXT3):24~31		
(Multiple Write)			
	FLC18E (EXT9):72~79		
	FLC18E (EXT10):80~87		
	FLC18E (EXT11):88~95		
	FLC18E (EXT12):96~103		
	.		
	.		
	FLC18E (EXT15):120~127		
	FLC18E (EXT16):128~135		

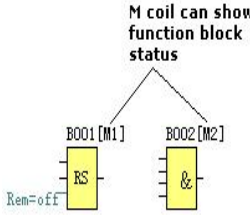
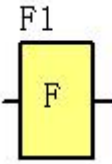
<p>Middle coil</p> <p style="text-align: center;">M coil can show function block status</p>  <p>(0x)</p> <p>(0x)</p> <p>MODBUS code: 01(read)</p>	<p>FLC12 Series:256~767 FLC18 Series:256~1279</p>	<p>BIT</p>	<p>R</p>
<p>Digital Flag</p>  <p>(0x)</p> <p>MODBUS code: 01(read) 05 (single Write)</p> <p>15 (Multiple Write)</p>	<p>FLC18/PR-14 series: 1536~1791 FLC12/PR-24 series: 1536~1791</p>	<p>BIT</p>	<p>R/W</p>

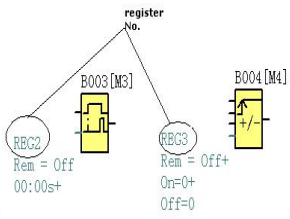
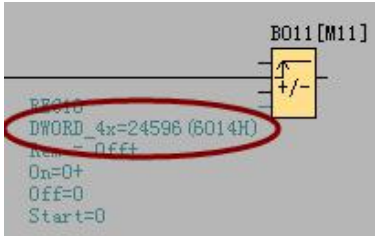
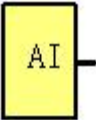
<p>REG</p> <p>Holding register(timer、counter value)</p>  <p>(4x)</p> <p>(4x)</p> <p>MODBUS code: 03(read)</p> <p>16(Multiple Write)</p> 	<p>FLC18 Series:0~1023</p> <p>FLC12 Series: 0~511</p>	<p>LONG</p>	<p>R/W</p> <p>Note:some modbus device cannot read the REG type, you can use the DWORD address to read or write the block value.</p>
<p>Analog input</p> <p>AI001</p>  <p>(4x)</p> <p>MODBUS code: 03(read)</p>	<p>FLC12 Series: 1024~1027</p> <p>FLC18 Series: CPU:1024~1031 EXT1:1032~1039 EXT2:1040~1047</p> <p>.....</p> <p>EXT9:1096~1103</p> <p>.....</p> <p>EXT15:1144~1151 EXT16:1152~1159</p>	<p>Signed short</p>	<p>R</p>

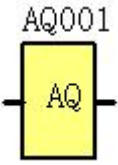
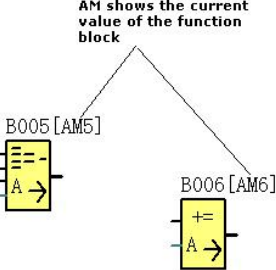
<p>Analog output</p>  <p>(4x)</p> <p>MODBUS code: 03(read)</p> <p>06(Single Write)</p> <p>16(Multiple Write)</p>	<p>FLC18 Series: CPU:1280~1281 EXT1:1282~1283 EXT2:1284~1285</p> <p>.....</p> <p>EXT9:1298~1299</p> <p>.....</p> <p>EXT15:1310~1311 EXT16:1312~1313</p>	<p>Signed short</p>	<p>R/W</p>
<p>Analog quantity buffer</p>  <p>(4x)</p> <p>MODBUS code: 03 (read)</p>	<p>FLC12 Series:1536~2047 FLC18 Series:1536~2559</p>	<p>Signed short</p>	<p>R</p>

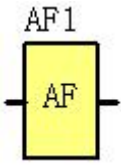
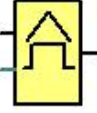
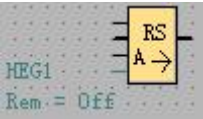
<p>Analog quantity buffer</p>  <p>(4x)</p> <p>MODBUS code: 03(read)</p> <p>06 (Single Write)</p> <p>16(Multiple Write)</p>	<p>FLC12 Series FLC18 Series: 3072~3327</p>	<p>Signed short</p>	<p>R/W</p>
<p>HEG for block</p> <p>The frequency value buffer of threshold trigger</p>  <p>Data latching Relay</p>  <p>(4x)</p> <p>MODBUS code: 03(read)</p> <p>16(Multiple Write)</p>	<p>FLC12 Series:2560~3071</p> <p>FLC18 Series: HEG0-HEG511:2560--3071</p> <p>HEG512 - HEG1023: 19456--19967</p>	<p>Word</p>	<p>R</p>
<p>RTC</p> <p>(4x)</p> <p>MODBUS code: 03(read)</p> <p>16(Multiple Write)</p>	<p>All FLC series CPU</p> <p>Year: 3328 Month: 3329 Day: 3330 Hour: 3331 Minute: 3332 Second: 3333</p>	<p>Signed short</p>	<p>R/W</p>

Appendix

A Technical data

A.1 General technical data

Criterion	Tested in accordance with	Values
FLC12 Series CPU		
Dimensions		72 x 90 x 61 mm
(W x H x D) Weight		Approx.300g
Installation		on a 35 mm profile rail or wall mounting
FLC18 Series CPU		
Dimensions		96 x 90 x 61 mm
(W x H x D) Weight		Approx.400g
Installation		on a 35 mm profile rail or wall mounting
FLC18E Series Expansion Module		
Dimensions		72 x 90 x 58 mm
(W x H x D)		Approx.300g
Weight		on a 35 mm profile rail or wall mounting
Installation		
Climatic conditions		
Ambient temperature Horizontal installation	Low temperature to IEC 6006821	-20 ... 55 °C
Vertical installation	High temperature to IEC 60068-2-2	-20 ... 55 °C
Storage/shipping		-40 °C ... +70 °C
Relative humidity	IEC 60068-2-30	From 10 to 95 % no condensation
Air pressure		795 ... 1080 hPa
Pollutants	IEC 60068-2-42	SO ₂ 10 cm ³ /m ³ ,4 days
	IEC 60068-2-43	H ₂ S 1 cm ³ /m ³ ,4 days

Criterion	Tested in accordance with	Values
Ambient mechanical conditions		
Protection mode		IP20
Vibrations:	IEC 60068-2-6	5 ... 9 Hz (constant amplitude 3.5 mm) 9 ... 150 Hz (constant acceleration 1 g)
Shock	IEC 60068-2-27	18 shocks (half-sine wave 15g/11 ms)
Drop	IEC 60068-2-31	Drop height 50 mm
Free fall (packaged)	IEC 60068-2-32	1 m
Electro-magnetic compatibility (EMC)		
Emission (Conducted Emission)	EN 55022	Class B
Emission (Radiated Emission)	EN 55022	Class B
Harmonics (Current Harmonics)	EN 61000-3-2	
Flicker (Voltage Fluctuation)	EN 61000-3-3	
ESD (Electrostatic Discharge)	EN 61000-4-2 Severity 3	8 kV air discharge 6 kV contact discharge
RF-Field (Radiated Immunity)	EN 61000-4-3	3V/m
Burst (Electrical Fast Transients)	EN 61 000-4-4	1 kV (supply and signal lines)
Surge (Transients comm.&diff.mode) (applies only to ELC-AC types)	EN 51000-4-5	0.5kV
RF-com.mode (RF continues conducted)	EN 61000-4-6	
V-dips (Voltage dips and Interruption)	EN 61000-4-11	
Cycle time		
Cycle time per function		<0.01ms

Output parameters:	
Output No.	4 (Q1-Q4)
Output type	Relay output
Continuous current	Resistive load 10A/Inductive load 2A
Max. breaking voltage	AC 250 V /DC 110 V
Max. Allowable Power Force	1250VA /300W
Electrical durability Expectancy	10 ⁵ Operations at Rated Resistive Load
Mechanical life	10 ⁷ Operations at No Load condition
Response time	Operate Time : 15 mSec. Max. Release Time : 10 mSec. Max.
Built-in protections	Against short-circuits: None Against overvoltages and overloads: None
Switch frequency:	
Mechanism	10Hz
Resistor/light load	2Hz
Sensitive load	0.5Hz
Other parameters:	
Function blocks	64 blocks
RTC accuracy :	MAX ±2S/day
RTC Backup at 25 °C	20 days
Program and settings Backup	10 Years
Data Power-off retentivity	No
Weight	Approx.300g
Short-circuit protection	External fuse required
Cycle time	typ. 0.6ms → 8.0ms
Connection cables	2 x 1.5 mm ² or 1 x 2.5 mm ²
Ambient temperature	-20 to + 55 °C
Storage temperature	-40 °C to + 70 °C
Certification	CE
Mounting	On 35 mm standard mounting rail, 4 MW, or wall-mounting
Dimensions	W x H x D (72*90*61 mm)
Programming cable	PC cable, (RS232 or USB)
Third party device (HMI) <=> FLC	Yes (work as modbus slave)
Extensions	No
High speed input	No
HMI	No
RS485 port	Can use PRO-RS485 cable to convert program port to RS485 port

Standard CPU Units (PR-18 series)	FLC18-12DI-6R
Power supply:	
Nominal voltage	DC 12-24V
Operating limits	DC 10.8-28.8V
Immunity from micro power cuts	Typ. 5 ms
Max. Startup current	Max. 0.25A
Max. absorbed power	3.5 W (10.8V dc) ; 4 W (28.8V dc)
Protection against polarity inversions	Yes
The main frequency range	---
Input parameters:	
Input No	12 (I1-IC)
Digital input	12 (I1-IC)
Analogue input	6 (I1-I6)(0..10V DC)
Input voltage	DC 0-28.8V
Input signal0	< 5V DC; <0.1mA(I1-I6), <1mA(I7-IC)
Input signal1	> 8 V DC; >0.3mA(I1-I6), >1.7mA(I7-IC)
Input current	0.4mA(I1-I6), 2.3mA(I7-IC), @ 10.8V dc 0.5mA(I1-I6), 2.6mA(I7-IC), @ 12.0 V dc 1.2mA(I1-I6), 5.2mA(I7-IC), @ 24 V dc 1.5mA(I1-I6), 6.3mA(I7-IC), @ 28.8 V dc
Input Response Time	Delay time at 0 to 1 : Typ. 1.5 ms (I1-I6), <1ms(I7-IC); Delay time at 1 to 0 : Typ. 1.5 ms(I1-I6), <1ms(I7-IC);

Maximum counting frequency	Typ.: 4 HZ
Sensor type	Contact or 3-wire PNP
Isolation between power supply and inputs	Resistive
Isolation between inputs	None
Protection against polarity inversions	None
Inputs used as analog inputs(I1-I6)	
Measurement range	DC 0---10V
Input impedance	Min, 24K Ω ; Max. 72K Ω
Input voltage	28.8 V DC max
Resolution	10bit ,0.01V
Accuracy at 25 °C	\pm (Max.0.02)V
Accuracy at 55 °C	\pm (Max.0.04)V
Isolation between analog channel and power supply	None
Cable length	10 m max. shielded and twisted
Output parameters:	
Output No.	6 (Q1-Q6)
Output type	Relay output
Continuous current	Resistive load 10A/Inductive load 2A (Relay)
Max. breaking voltage	AC 250 V /DC 110 V(Relay)
Max. Allowable Power Force	1250VA /300W(Relay)
Electrical durability Expectancy	10 ⁵ Operations at Rated Resistive Load(Relay)
Mechanical life	10 ⁷ Operations at No Load condition(Relay)
Response time	Operate Time : 15 mSec. Max.(Relay) Release Time : 10 mSec. Max.(Relay)
Built-in protections	Against short-circuits: None Against overvoltages and overloads: None
Switch frequency:	
Mechanism	10Hz
Resistor/light load	2Hz
Sensitive load	0.5Hz
PWM frequency	---

PWM accuracy at 500Hz	---
Other parameters:	
Function blocks	1024 blocks
RTC accuracy :	MAX ±2S/day
RTC Backup at 25 °C	20 days
Program and settings Backup	10 Years
Data Power-off retentivity	Yes
Weight	Approx.400g
Short-circuit protection	External fuse required
Cycle time	typ. 0.6ms → 8.0ms
Connection cables	2 x 1.5 mm ² or 1 x 2.5 mm ²
Ambient temperature	-20 to + 55 °C
Storage temperature	-40 °C to + 70 °C
Certification	CE
Mounting	On 35 mm standard mounting rail, 4 MW, or wall-mounting
Dimensions	W x H x D (72*90*61 mm)
Programming cable	PC cable, (RS232 or USB)
Third party device(HMI) <=> FLC	Yes (work as modbus master or slave)
Extensions	Yes(Can connect up to 16 pcs PR-E extensions.)
High speed input	No I9---IC(60kHz)
HMI	Yes
RS485 port	Option1:Can use PRO-RS485 cable to convert program port to RS485 port Option2:Or use PR-RS485 extension module

Program and settings Backup	10 Years
Data Power-off retentivity	Yes
Weight	Approx.500g
Short-circuit protection	External fuse required
Cycle time	typ. 0.6ms → 8.0ms
Connection cables	2 x 1.5 mm ² or 1 x 2.5 mm ²
Ambient temperature	-20 to + 55 °C
Storage temperature	-40 °C to + 70 °C
Certification	CE
Mounting	On 35 mm standard mounting rail, 4 MW, or wall-mounting
Dimensions	W x H x D (133*90*61 mm)
Programming cable	PC cable, (RS232 or USB)
Third party device(HMI) <=> FLC	Yes (work as modbus master or slave)
Extensions	Yes(Can connect up to 16 pcs PR-E extensions.)
High speed input	No I9---IC(60kHz)
HMI	Yes
RS485 port	Option1:Can use PRO-RS485 cable to convert program port to RS485 port Option2:Or use PR-RS485 extension module Option3:built-in RS485 port is available

Extension Units (FLC18E Series)	FLC18E-8DI-8R	FLC18E-8DI-8TN
Power supply:		
Nominal voltage	DC 12-24V	
Operating limits	DC 10.8-28.8V	
Immunity from micro power cuts	Typ. 5 ms	
Max. Startup current	Max. 0.25A	
Max. absorbed power	3.5 W (10.8V dc) ; 4.5 W (28.8V dc)	
Protection against polarity inversions	Yes	
The main frequency range	---	
Input parameters:		
Input No	8 (I1-I8)	
Digital input	8 (I1-I8)	
Analogue input	4 (I1-I4)(0..10V DC)	
Input voltage	DC 0-28.8V	

Input signal0	< 5V DC;<0.1mA(I1-I4),<1mA(I5-I8)	
Input signal1	> 8 V DC;>0.3mA(I1-I4),>1.7mA(I5-I8)	
Input current	0.4mA(I1-I4),2.3mA(I5-I8),@ 10.8V dc 0.5mA(I1-I4),2.6mA(I5-I8),@ 12.0 V dc 1.2mA(I1-I4),5.2mA(I5-I8),@ 24 V dc 1.5mA(I1-I4),6.3mA(I5-I8),@ 28.8 V dc	
Input Response Time	Delay time at 0 to 1 : Typ. 1.5 ms (I1-I4),<1ms(I5-I8); Delay time at 1 to 0 : Typ. 1.5 ms(I1-I4),<1ms(I5-I8);	
Maximum counting frequency	Typ.: 4 HZ	
Sensor type	Contact or 3-wire PNP	
Isolation between power supply and inputs	Resistive	
Isolation between inputs	None	
Protection against polarity inversions	None	
Inputs used as analog inputs(I1-I4)		
Measurement range	DC 0---10V	
Input impedance	Min, 24K Ω ; Max. 72K Ω	
Input voltage	28.8 V DC max	
Resolution	9bit ,0.015V	
Accuracy at 25 °C	\pm (Max.0.02)V	
Accuracy at 55 °C	\pm (Max.0.04)V	
Isolation between analog channel and power supply	None	
Cable length	10 m max. shielded and twisted	
Output parameters:		
Output No.	8 (Q1-Q8)	8 (Q1-Q8)
Output type	Relay output	Transistor output
Continuous current	Resistive load 10A/Inductive load 2A (Relay)	0.3A(Transistor)
Max. breaking voltage	AC 250 V /DC 110 V(Relay)	DC 30V(Transistor)
Max. Allowable Power Force	1250VA /300W(Relay)	9W(Transistor)
Electrical durability Expectancy	10 ⁵ Operations at Rated Resistive Load(Relay)	---
Mechanical life	10 ⁷ Operations at No Load condition(Relay)	---
Response time	Operate Time : 15 mSec. Max.(Relay) Release Time : 10 mSec. Max.(Relay)	Operate Time : <1 ms Release Time : <1 ms
Built-in protections	Against short-circuits: None Against overvoltages and overloads: None	
Switch frequency:		

Mechanism	10Hz	---
Resistor/light load	2Hz	10HZ
Sensitive load	0.5Hz	0.5HZ
Other parameters:		
Connection cables	2 x 1.5 mm ² or 1 x 2.5 mm ²	
Ambient temperature	-20 to + 55 °C	
Storage temperature	-40 °C to + 70 °C	
Certification	CE	
Mounting	On 35 mm standard mounting rail, 4 MW, or wall-mounting	
Dimensions	W x H x D (133*90*61 mm)	

Extension Units (PR-E series)	FLC18E-4AI-I	FLC18E-3PT100	FLC18E-2AQ-VI
Power supply:			
Nominal voltage	DC 12-24V		DC 24V
Operating limits	DC 10.8-28.8V		DC 19.2-28.8V
Immunity from micro power cuts	Typ. 5 ms		
Max. Startup current	Max. 0.25A		
Max. absorbed power	3.5 W (10.8V dc) ; 4.5 W (28.8V dc)		
Protection against polarity inversions	Yes		
Input parameters:			
Input No	4 (I1-I4)	3 PT100	---
Digital input	None	None	---
Analogue input	I1-I4(0/4...20mA)	3PT100	---
Analog inputs			
Measurement range	0/4...20mA	-50°C--200°C	---
Resolution	0.02mA	0.3°C	---
Accuracy at 25 °C	Max. 0.05mA	< 1 °C	---
Isolation between analog channel and power supply	---	None	
Cable length	---	10 m max. shielded and twisted	
Output parameters:			
Output No.	---		2(AQ1-AQ2)
Output type	---		0...10V/0...20mA
Resolution	---		0.01V/0.02mA
Accuracy at 25 °C	---		0.02V/0.05mA
Other parameters:			

Weight	Approx.400g
Short-circuit protection	External fuse required
Cycle time	typ. 0.6ms → 8.0ms
Connection cables	2 x 1.5 mm ² or 1 x 2.5 mm ²
Ambient temperature	-20 to + 55 °C
Storage temperature	-40 °C to + 70 °C
Certification	CE
Mounting	On 35 mm standard mounting rail, 4 MW, or wall-mounting
Dimensions	W x H x D (72*90*58 mm)

RS485 communication module (FLC-RS485)	FLC-RS485
Power supply:	
Nominal voltage	DC 12-24V
Operating limits	DC 10.8-28.8V
Immunity from micro power cuts	Typ. 5 ms
Max. Startup current	Max. 0.1A
Max. absorbed power	1.5 W (10.8V dc) ; 1.8W W (28.8V dc)
Protection against polarity inversions	Yes
Input parameters:	
None	
Output parameters:	
None	
Other parameters:	
Weight	Approx.400g
Short-circuit protection	External fuse required
Connection cables	2 x 1.5 mm ² or 1 x 2.5 mm ²
Ambient temperature	-20 to + 55 °C
Storage temperature	-40 °C to + 70 °C
Certification	CE
Mounting	On 35 mm standard mounting rail, 4 MW, or wall-mounting
Dimensions	W x H x D (72*90*58 mm)

A.2 Switching capacity and service life of the relay outputs

Ohmic load

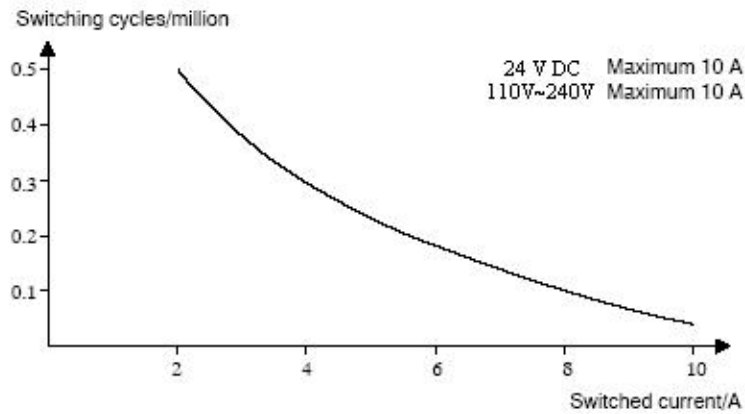

Figure A Switching capacity and service life of the contacts with ohmic load (heating)

Inductive load

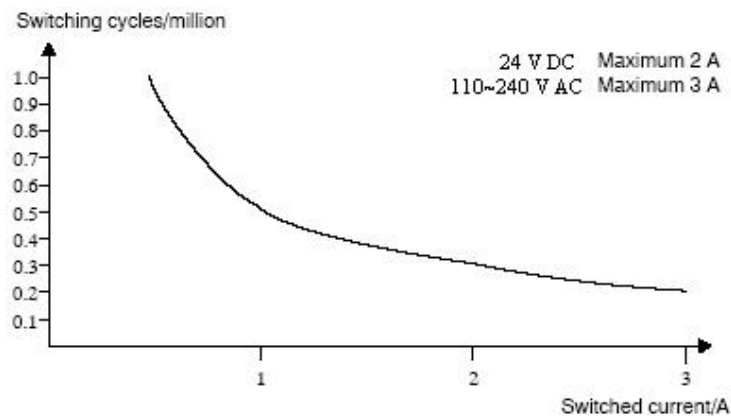

Figure B Switching capacity and service life of the contacts with high inductive load (contactors, solenoid coils, motors).

REVISION RECORD

Revision	Description

X-ON Electronics

Largest Supplier of Electrical and Electronic Components

Click to view similar products for [F&F manufacturer](#):

Other Similar products are found below :

[AC-1I 15A](#) [AC-1I 5A](#) [AS-212](#) [AS-221T](#) [AS-223](#) [AS-225](#) [AS-225D](#) [AS-B220](#) [ASO-205](#) [AT-1I](#) [AT-1U](#) [AT-2U](#) [AT-3I](#) [AV-1I](#) [AWZ](#) [AWZ-30](#) [AZ-112](#) [AZ-112-LED](#) [AZ-112 PLUS](#) [AZH-LED](#) [AZH-MINI-LED](#) [AZH-S 12V](#) [AZHS-230V](#) [BIS-402](#) [BIS-403](#) [BIS-404](#) [BIS-408 230V](#) [BIS-408I 230V](#) [BIS-409 230V](#) [BIS-410 230V](#) [BIS-410I 230V](#) [BIS-411 230V](#) [BIS-411 24V AC/DC](#) [BIS-411B](#) [BIS-411B-LED](#) [BIS-411BM](#) [BIS-411BM-LED](#) [BIS-411I 230V](#) [BIS-411I 24V AC/DC](#) [BIS-412 230V](#) [BIS-412 24V AC/DC](#) [BIS-412I 230V](#) [BIS-413 230V](#) [BIS-413 24V AC/DC](#) [BIS-413I 230V](#) [BIS-414 24V AC/DC](#) [BIS-419 230V](#) [BIS-419I 230V](#) [CKF-316](#) [CKF-316-TRMS](#)