



F&F Filipowski sp. j.
Konstantynowska 79/81, 95-200 Pabianice, POLAND
phone/fax (+48 42) 215 23 83 / (+48 42) 227 09 71
www.fif.com.pl; e-mail: biuro@fif.com.pl

PCZ-528.3

Programmable
control timer



Do not dispose of this device in the trash along with other waste!

According to the Law on Waste, electro coming from households free of charge and can give any amount to up to that end point of collection, as well as to store the occasion of the purchase of new equipment (in accordance with the principle of old-for-new, regardless of brand). Electro thrown in the trash or abandoned in nature, pose a threat to the environment and human health.



Purpose

The PCZ-528.3 control timer is a universal programmable timer that combines the features of an astronomical, weekly and annual timer.

Features of the timer

- » 256 programs for switching the relay on/off;
- » Each of the programs can be executed in one of the seven date intervals defined in the annual cycle;
- » Ability to enter up to 32 holidays and select which programs will run on holidays;
- » For each of the work programs, it can be independently determined whether the program will be executed in an hourly cycle (fixed hour and minute) or in an astronomical cycle (related to the position of the sun in relation to the horizon);
- » In each of the astronomical programs, it is possible to set an independent shift of switching on/off in relation to the selected astronomical point (e.g. turn on one hour before sunset, turn off two hours after dusk);

- » For each of the programs, you can freely choose which days of the week it will be performed;
- » Possibility to program the timer with the free PCZ Konfigurator mobile application using the NFC* short-range radio communication system;
- » Possibility to protect the clock settings with a PIN code;
- » Advanced work time counter that allows you to measure the receiver activation time:
 - on the current day and month;
 - monthly, from the last 12 months;
 - total from the moment the clock was first started.
- » Auxiliary, resettable, work time counter;
- » Possibility of limiting the total time of the receiver activation (up to a maximum of 99999 hours);
- » Control input that allows connection of momentary external button;
- » Backlit LCD display with adjustable brightness and contrast levels;
- » Replaceable 2032 type battery to keep the clock running in case of power failure**.

* *Remote programming requires an Android phone with built-in NFC communication and free PCZ Configurator app (downloadable from Google Play store). NFC communication range is limited to a few centimeters, so a direct phone-to-timer connection is required to transfer the configuration from the app to the timer.*

** *In the event of a power failure, the internal battery will only support the internal clock so that the current time and date will not be lost. In the event of a power failure, all external timer functions, such as the display and relay, remain disabled.*

Functioning

The PCZ-528.3 clock controller can operate in one of the three modes of operation:

» **Automatic mode**

Operation in automatic mode involves the automatic processing of all programs stored in the memory of the controller.

» **Semi-automatic mode**

Semi-automatic mode means a temporary interruption of operation in automatic mode and the possibility of manually switching the relay contact to the opposite position. The timer operation in semi-automatic mode is indicated by blinking of the timer dial on the controller display. Operation in semi-automatic mode is stopped when the next operating program is activated, after which the controller returns to automatic mode.

» **Manual mode**





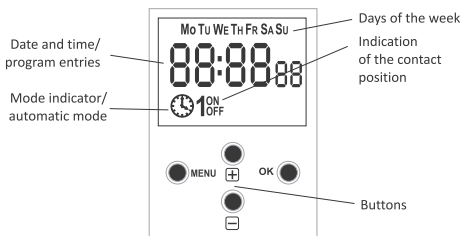

In manual mode, the list of programs stored in the memory of the controller is ignored and switching on/off is performed manually by the user.

In manual mode, the state of the relay can be changed by briefly pressing the +/– button on the front of the controller or an external button connected to the timer control input.



Display description



Operation mode indication

Display	Mode	Relay status
 1 ON OFF	Automatic	ON
 1 ON OFF	Automatic	ON
 1 ON OFF	Semi-automatic	ON
 1 ON OFF	Semi-automatic	OFF
 1 ON OFF	Manual	ON
 1 ON OFF	Manual	OFF

Legend:

	ON
	Blinks/pulses
	OFF

Control buttons

Button	Description
MENU	<p>Press the button to enter the controller configuration mode.</p> <p>In parameter editing mode, pressing Menu abandons the edited parameter (without remembering the changes made) and returns to the parent menu level.</p> <hr/>
OK	<p>Press the button in edit mode to edit the next setting item. If you are editing the last item, pressing the OK button will save the new parameter value, exit the edit mode and go to the parent menu level.</p> <p>Pressing the OK button in the time display mode will bring up a quick access menu allowing you to view information about the current date, details of the currently running program, and access to operating time statistics..</p> <hr/>

continued on next page

Control buttons cont.

Button	Description
+ (Up)	<p>In edit mode, pressing the button increases the value of the edited parameter by 1. If the button is pressed for a long time, the parameter value will cyclically increase by 1.</p> <p>In manual operation mode, pressing the button will switch the contact permanently (ON -> OFF or OFF->ON).</p> <p>In automatic operation mode, pressing the button toggles between automatic and semi-automatic mode.</p> <hr/>
- (Down)	<p>In edit mode, pressing the button decreases the value of the edited parameter by 1. If the button is pressed for a long time, the parameter value will cyclically decrease by 1.</p> <p>In manual operation mode, pressing the button will switch the contact permanently (ON -> OFF or OFF->ON).</p> <p>In automatic operation mode, pressing the button toggles between automatic and semi-automatic mode.</p> <hr/>

Mounting

1. Turn off the power.
2. Install the clock on the rail in the distribution box.
3. Connect the power cables according to the diagram.
4. Connect receivers according to the diagram.
5. Set the correct date and time.
6. Make software configuration of the clock.

Controller diagram

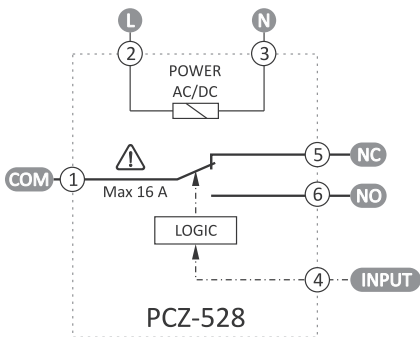

Wiring diagram

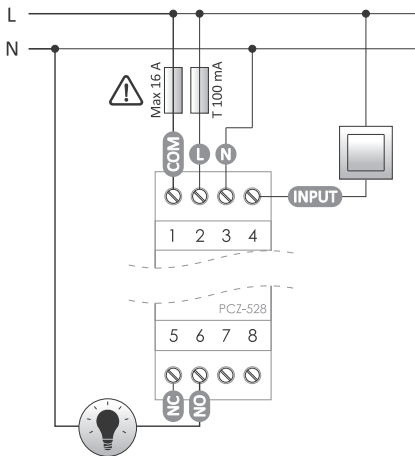

- 1 COM relay power supply
- 2 L power supply
- 3 N power supply
- 4 control input (triggered by L/N/+ level)
- 5 NC contact (normally closed)
- 6 NO contact (normally open)



The full version of the manual for the PCZ-528 timer can be downloaded from www.fif.com.pl from the product subpage or by using the QR code below:



Mobile app

The control application is available free of charge in the Google Play store:

Aplikacja dostępna na:



<https://play.google.com/store/apps/details?id=pl.com.fif.clockprogramer>



The NFC connection uses very short-range communication, which means that you need to directly touch the phone to the front of the programmed controller.

Technical data

power supply	24÷264 V AC/DC
maximum load current (AC-1)	16 A
contact	separated 1×NO/NC
backup time clock operation	6 years*
battery type	2032 (lithium)
backup time display operation	none
accuracy of the clock	1 s
error time	±1 s/ 24 h
power consumption	1.5 W
terminal	2.5 mm ² screw terminals (cord) 4.0 mm ² screw terminals (wire)
tightening torque	0.5 Nm
working temperature	-20÷50°C
dimensions	2 modules (35 mm)
mounting	on TH-35 rail
ingress protection	IP20

* *Battery life depends on operating conditions and how long the timer is powered by battery only. Low ambient temperature greatly reduces the life of the battery.*

Warranty

The F&F products are covered by a warranty of the 24 months from the date of purchase. Effective only with proof of purchase. Contact your dealer or directly with us.

CE declaration

F&F Filipowski sp. j. declares that the device is in conformity with the essential requirements of Directive 2014/53/EU of the European Parliament and of the Council of 16 April 2014 on the harmonization of the laws of the Member States relating to the making available on the market of radio equipment and repealing Directive 1999/5/EC.

The CE Declaration of Conformity, along with the references to the standards in relation to which conformity is declared, can be found at www.fif.com.pl on the product page.

X-ON Electronics

Largest Supplier of Electrical and Electronic Components

Click to view similar products for [Timers](#) category:

Click to view products by [F&F](#) manufacturer:

Other Similar products are found below :

[H5S-WFB2D](#) [304E-007-A-00-PX](#) [305E-015-A-1-0-PX](#) [THR2U-110A](#) [81506944](#) [H7AN-RT6M AC100-240](#) [711-0131](#) [600DT-CU](#)
[1SVR508130R0000](#) [1SVR730100R3100](#) [1SVR740040R3300](#) [H3Y-2 AC24 10S](#) [81503028](#) [722-0001](#) [732-0023](#) [80.01.0.240.0000T](#)
[81.01.0.230.0000T](#) [12.A4.8.230.0010](#) [85.03.0.024.0000](#) [80.61.0.240.0000T](#) [LTR10](#) [SL555D](#) [SA555DR-HXY](#) [NE555P-HXY](#) [KG316T-D](#)
[AC220V](#) [JSZ3A-E AC220V](#) [JSZ3A-F AC220V](#) [JSS48A-2Z AC/DC24V-48V](#) [JSZ3C-B AC220V](#) [JSZ6-2 10s DC24V](#) [JSZ6-2 60s DC24V](#)
[JSZ3Y 30s AC220V](#) [JS14P 999s AC220V](#) [JS14P 99s AC220V](#) [KG10M AC220V](#) [JSZ3A-A AC220V](#) [JSZ3A-B DC24V](#) [JSS48A-2Z AC220V](#)
[JSZ6-2 10s AC220V](#) [JSZ3F 30s AC220V](#) [JZF-07 AC220V](#) [JSZ3A-B AC220V](#) [JS14P 99s AC380V](#) [JSZ3F 60s AC220V](#) [710037400000004](#)
[NKG3-M AC220V](#) [JSZ3A-D AC220V](#) [JSZ6-2 60s AC220V](#) [KG10D-1H AC220V](#) [JSS48A AC220V](#)