

ARCA IEC

PROTECTION IN DEMANDING ENVIRONMENTS

ENGLISH / GERMAN



CREATING CUSTOMER ADVANTAGE

Fibox' sophisticated quality assurance system makes our products and services reliable and consistent. From design and development to production and product delivery, everything is documented to ensure superior performance you can trust. Fibox has been an ISO 9001 certified manufacturer since 1992. Our latest accreditation is to ISO 9001:2015

THE FIBOX QUALITY SYSTEM

Our system ensures product quality and safety, availability of product, accuracy of shipments, technical support and customer service. Regular internal and independent external audits make sure of that.

EIN VERITABLER KUNDENVORTEIL

Das differenzierte Qualitätsmanagementsystem von Fibox stellt sicher, dass unsere Kunden sich jederzeit auf die Qualität und Konformität unserer Produkte und Serviceangebote verlassen können. Von Konstruktion und Entwicklung bis hin zu Produktion und Warenlieferung – alles wird für verlässliche, zertifizierte Qualität dokumentiert! FIBOX wurde schon im Jahre 1992 ein ISO 9001-zertifizierter Hersteller, inklusive Normvorschrift nach ISO 2001:2015.

DAS FIBOX QUALITÄTSSICHERUNGSSYSTEM

Das Fibox-Qualitätssicherungssystem stellt die Effizienz von Produktqualität und Sicherheitsaspekten, Logistik, Versandabwicklung, Kundenbetreuung, Serviceangeboten und Ersatzteilservices sicher. Das gewährleisten regelmäßige interne und unabhängige, externe Audits.



FIBOX ARCA CABINETS

FIBOX ARCA WANDSCHALTSCHRÄNKE

The Fibox reputation is built on two foundation stones. Firstly we understand the demands of the market we operate in, and secondly we manufacture a breadth of products which is unrivalled in terms of choice, technical innovation and quality. Our experienced personnel, situated globally, are on hand at all times to offer you any support you may require at every stage of your project, from inception to despatch.

THE ANSWER IS YES, NOW WHAT IS YOUR QUESTION?

This catalogue covers ARCA IEC, an innovative new range of glass filled polycarbonate cabinets. The market demanded a viable alternative to the thousands of steel cabinets installed every year in totally unsuitable environments. You even helped us to integrate the features you need. The result can be viewed in the following pages but below are just a few highlights:

- Totally non corrosive and UV stabilised
- IP66 Ingress protection and IK 10 (IK08/IP65 on window versions) Impact protection
- A multitude of locking options and accessories
- Easy to machine in situ or in the workshop with no harmful swarf residue
- All the features of steel. All the benefits of high grade thermoplastic

FIBOX WEB SERVICES

Visit www.fibox.com to keep up to date with the latest developments from Fibox. Our interactive website can also assist you in selecting the right enclosure for your requirement first time by providing you with a 2D/3D CAD download facility, dimensional drawings, detailed material and performance specifications and regulatory approvals. The latest product catalogues and leaflets are also available to download from the Fibox website. Wherever you are in the world there is access to the Fibox website in local languages. These are Chinese, Danish, Dutch, English, Finnish, French, German, Japanese, Korean, Polish, Russian and Swedish. Help us to improve our web offering by giving us feedback. We are always very willing to listen to your comments and adopt change wherever possible.

FIBOX CUSTOMISING SERVICE

Your local Fibox representative is an expert in our added value service which is extensive, and designed to offer our customers a ready to use product and to take the strain away from your supply chain. This service will be discussed with you when you make your enclosure enquiry to us, but in a nutshell it covers the following functions:

- Drilling, milling, tapping
- Special colours, whether painted or moulded
- Customised, product specific tooling
- Printing and graphics
- Assembly service, including special metalwork and bracketry
- EMC protection

The Fibox team is waiting for your enclosure enquiry and we will strive to give you the best service possible.

Der Markenname FIBOX steht seit 1966 als Synonym für die Produktion und weltweite Verfügbarkeit von qualitativ hochwertigen Gehäusen für schwierige und anspruchsvolle Umgebungen. Dafür, dass unsere Gehäuse gefertigt werden, um widrigen Umständen zu trotzen, kann unsere Baureihe EK angesehen werden, die seit den 60er Jahren gefertigt, noch heute tut, wofür sie geschaffen wurde.....schützen. Die Basis des andauernden Fibox' Erfolges ist eine zwei-Säulen Strategie. Profundes Wissen über die Anforderungen des Marktes in dem wir tätig sind, gepaart mit langjähriger Erfahrung in Engineering und Fertigungstechnik innerhalb der Gehäuseindustrie.

Das Wort „Partner“ wird bei Fibox sehr ernst genommen. Unser Ziel ist es, Ihnen, unseren Kunden, ein Partner zu sein. Um das zu erreichen, müssen wir mehr anbieten als nur Gehäuse. Deshalb sind unsere Vertriebsteams bestrebt, zusammen mit Ihnen die richtige „Verpackung“ für Ihre Anforderungen zu entwickeln. Ganz gleich, ob es einfache Klemmgehäuse sind oder komplexe Verteilungen, die spezielle elektrische Bauteile oder besondere Montagen beinhalten, Fibox hat die Möglichkeit, Ihnen Lösungen anzubieten, die sich in Ihre Lieferkette nahtlos einfügen. Wir wissen – Produkte als solche sind nicht alles, viele Faktoren sind für Ihren Erfolg wichtig.

Dieser Katalog widmet sich Fibox ARCA, einer brandneuen Reihe von robusten Wandschaltsschränken, gefertigt aus Polycarbonat. Damit unterstreicht Fibox den Anspruch marktorientiert und innovativ zu entwickeln. Nach zwei Jahren Entwicklungszeit ist ARCA nun verfügbar. Der Markt bekommt eine praktikable und kostengünstige Alternative zu vielen Stahlblechschränken, die in ungünstigen Umgebungen installiert sind.

Kurz gesagt, alle Eigenschaften von Stahl aber gefertigt aus hochwertigem technischen Kunststoff.

EINIGE VORTEILHAFTE EIGENSCHAFTEN, DIE SIE IM DETAIL AUF DEN FOLGENDEN SEITEN IN DIESEM KATALOG FINDEN:

- Korrosionsbeständig
- Schutzart IP66 (IP65 Fensterversionen)
- Schlagfestigkeit IK 10 (IK 08 Fensterversionen)
- Alle gängigen Verschlussvarianten
- Zeitgemäßes Design
- UV stabilisiertes Polycarbonat
- Einfache mechanische Bearbeitung vor Ort oder in der Werkstatt
- Glatte Oberfläche für Siebdruck oder zum Einbau von Komponenten

Die Fibox ARCA – Serie in diesem Katalog baut auf die Tradition der im Jahr 2007 in den USA und Kanada eingeführten Serie ARCA JIC auf, die sich in dieser kurzen Zeit in diesem anspruchsvollen Markt durchgesetzt hat. Wir sind sicher, dass auch unsere neue Serie ARCA einen ähnlichen Eindruck hinterlassen wird.

In diesem Katalog, so glauben wir, werden Sie die richtige Basis für Ihre Wandschaltsschränke finden. Deshalb sehen wir Ihrer Bitte (alternativ Anfrage), sie bei Ihren Entwicklungen unterstützen zu dürfen, gerne entgegen.

Fibox arbeitet weltweit, wo immer Sie auch sind, eine Fibox Vertretung ist nicht weit entfernt.

Ihr Fibox-Team

FIBOX GASKETS OFFER THE BEST PROTECTION

Fibox enclosures are designed and manufactured with the greatest of care, right down to the sealing gasket. By choosing the right gasket material for the installation environment and your application the performance of the enclosure will be optimised. What makes an excellent seal is determined by these six criteria:

- Compression set
- Temperature resistance
- Resistance to chemicals
- Tensile strength
- Breaking elongation
- Hardness

These criteria will determine the suitability of the required sealing material. Fibox enclosure can be equipped with PUR, EPDM, Neoprene or silicon gaskets. Each material has specific benefits, e.g. PUR has an exceptionally low compression set while EPDM seals have the highest resistance to chemicals.

To find the optimal gasket material for your application you should first compare each material's elastic properties. We then recommend subjecting your chosen gasket to a suitability test to temperature and chemical exposure.

Another important factor is how the sealing gasket is fitted to the enclosure. Fibox attaches great importance to this facet of a gasket's manufacture because we want to offer you the most suitable enclosure seal. Fibox combines the production precision of the enclosure with the sealing force of the contact surfaces and the CSA of the gasket.

GUIDELINES FOR INSTALLING ENCLOSURES AND CABINETS IN OUTDOOR APPLICATIONS

When selecting an enclosure for outdoor applications the IP (Ingress Protection) rating and UV resistance are often the only criteria considered.

It should be noted that these tests are carried out under laboratory conditions and are conducted over short, defined time periods.

When installing enclosures in outdoor applications consideration should be given to other factors.

The enclosure and/or cabinet should be installed using the standard installation fixtures like wall mounting kits or using the wall fastening holes designed for the purpose. Cabinets are designed and tested for upright/wall mounting purpose only.

Extreme weather conditions such as snow, ice and heavy rain have a major influence. It is obvious that exposure to the actual elements is over a much longer period than in a laboratory.

To optimize the performance of the installed enclosure the possibility of internal condensation should also be assessed. It may be necessary to incorporate heating or ventilation equipment to eradicate this.

Thought should also be given to the likelihood of the installation coming into contact with corrosive chemicals.

In order to minimize the environmental risks to outdoor installations, the fitting of a simple roof should be considered to protect against the effects of extreme weather conditions and strong UV.

FIBOX-GEHÄUSEDICHTUNGEN BIETEN DEN BESTEN SCHUTZ

FIBOX-Gehäuse sind mit größter Sorgfalt konstruiert und gefertigt und das gilt auch für die Dichtung. Denn je besser die Dichtung, desto höher der IP-Schutz des Gehäuses. Was genau eine hervorragende Dichtung ausmacht, entscheiden diese sechs Werkstoffeigenschaften:

- Druckverformungsrest
- Temperaturbeständigkeit
- Chemikalienbeständigkeit
- Zugfestigkeit
- Bruchdehnung
- Härte

Diese Eigenschaften sind gute Richtwerte für das Betriebsverhalten des jeweiligen Dichtungsmaterials. FIBOX-Gehäuse sind mit Dichtungen aus PUR, EPDM, Neopren oder Silikon ausgestattet. Jedes dieser Materialien hat spezifische Vorteile: Polyurethan etwa hat einen außergewöhnlich niedrigen Druckverformungsrest und EPDM-Dichtungen sind am beständigsten gegenüber Chemikalien.

Um das optimale Dichtungsmaterial für Ihre Anwendung zu finden, vergleichen Sie am besten zuerst die Elastizitätseigenschaften der verschiedenen Dichtungsmaterialien. FIBOX empfiehlt Ihnen anschließend eine Eignungsprüfung des gewählten Materials für Ihre Anwendung in Hinsicht auf Temperatur- und Chemikalieneinwirkung.

Ein weiterer wichtiger Punkt: der gute Sitz der Dichtung. FIBOX legt größten Wert auf diesen Fertigungspunkt, um Ihnen die beste Gehäuse-dichtung anbieten zu können. FIBOX achtet auf optimales Zusammenspiel von Fertigungspräzision des Gehäuses, Dichtungskraft der Kontaktflächen und Querschnittsstruktur der Dichtung.

MONTAGEANLEITUNG FÜR OUTDOOR-GEHÄUSE UND -SCHRÄNKE

Bei der Auswahl von Gehäusen für den Außeneinsatz werden häufig nur die Kriterien IP-Schutzgrad (IP steht für Ingress Protection / Eindringenschutz) und UV-Beständigkeit berücksichtigt.

Allerdings werden die betreffenden Tests unter Laborbedingungen und nur über kurze, genau festgelegte Zeiträume durchgeführt. Bei der Installation von Outdoor-Gehäusen ist es daher sinnvoll, einigen weiteren Faktoren Beachtung zu schenken. Gehäuse und/oder Schränke sollten unter Verwendung der Standard-Montagevorrichtungen wie z. B. Wandmontagesets oder für diesen Zweck vorgesehene Wandbefestigungsbohrungen montiert werden. Schränke sind nur für die stehende Montage/Wandbefestigung konzipiert und geprüft.

Extreme Wetterbedingungen wie z. B. Eis, Schnee und starker Regen haben maßgeblichen Einfluss auf Außengehäuse und

natürlich wirken diese Witterungseinflüsse, anders als in der Laborsituation, über viel längere Zeiträume auf die Outdoor-Komponenten ein.

Zur Verbesserung der Leistungsfähigkeit außenmontierter Gehäuse sollte auch die Möglichkeit geräteinterner Kondensation bedacht werden. Unter Umständen ist eine Heiz- oder Lüftungsvorrichtung erforderlich, um eine Innenkondensation zu verhindern.

Ferner sollte überlegt werden, wie groß die Wahrscheinlichkeit ist, dass das betreffende Gehäuse mit korrosiven Chemikalien in Kontakt kommt.

Um die Umgebungseinflüsse auf Outdoor-Gehäuse so gering wie möglich zu halten, sollte das Gehäuse schließlich durch ein einfaches Dach geschützt sein, um die Auswirkungen extremer Witterungsbedingungen und starker UV-Belastung zu minimieren.

IP AND IK CLASSIFICATIONS

IP UND IK KLASSIFIKATIONEN

Ingress protection class of enclosures is given in the form of IP classification, a two digit coding which is shown below. Fibox has tested the enclosures according to EN 60529. The standard requires the second digit to be tested from class 6 upwards separately to each level of class, thus the double marking IP 66 / IP 67 indicates that the actual tests have been made for both levels.

The new European standard for empty enclosures, EN 62208 includes the IK impact test too. This test is described in EN 62262, and as Fibox enclosures are tested to EN 62208, the data for impact resistance will be available as well.

Die Güte des Eindringenschutzes von Gehäusen wird durch die IP-Klassifikation angegeben - ein zweistelliger Code, der in der nachfolgenden Tabelle aufgeschlüsselt wird. FIBOX prüft seine Gehäuse nach EN 60529, welche verlangt, dass die zweite Ziffer von der Klasse 6 aufwärts für jede Stufe getrennt werden muss: die zweifach Markierung IP 66 / IP 67 zeigt an, dass die entsprechenden Prüfungen für beide Schutzklassen durchgeführt werden muss.

Der neue europäische Standard für Gehäuse EN 62208 enthält zusätzlich die neue Testklasse IK für Schlagfestigkeit, deren Testkriterien in der EN 62262 dargelegt werden. Da FIBOX-Gehäuse gemäß der Norm EN 62208 getestet sind, stehen die Schlagfestigkeitswerte ebenfalls zur Verfügung.

IP AND IK CLASSIFICATIONS IP UND IK KLASSENIKATIONEN

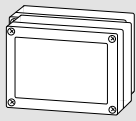
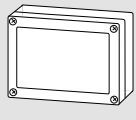
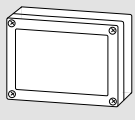
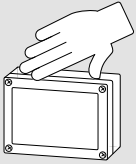
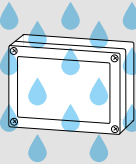
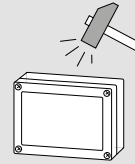
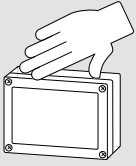
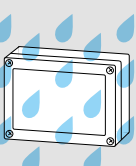
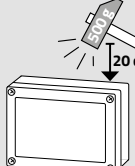
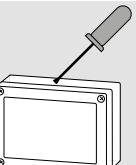
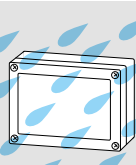
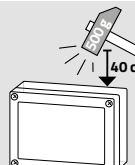
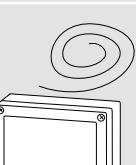
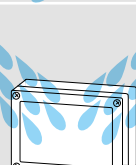
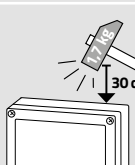
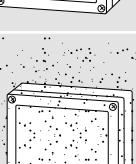
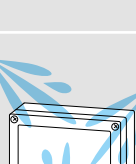
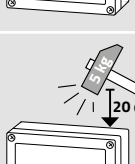
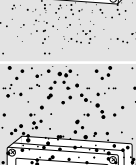
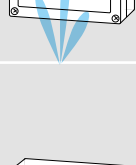
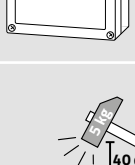
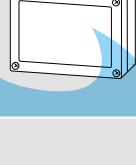
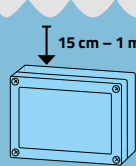
FIRST IP NUMBER Protection against solid objects Berührungs- und Fremdkörperschutz			SECOND IP NUMBER Protection against liquids Wasserschutz			IK CODE Protection against mechanical impacts Schutz gegen mechanischen Schlag		
IP	Example	Test	IP	Example	Test	IK	Example	Test
0		no protection Kein Schutz	0		no protection Kein Schutz	00		no protection Kein Schutz
1		protected against solid objects over 50 mm e.g. accidental touch by hands Geschützt gegen feste Objekte bis 50 mm, z.B. zufällige Handberührung	1		protected against vertically falling drops of water Geschützt gegen senkrecht fallendes Tropfwasser	01 - 05		impact < 1 joule Schlag < 1 joule
2		protected against solid objects over 12 mm e.g. fingers Geschützt gegen feste Objekte bis 12 mm, z.B. Finger	2		protected against direct sprays of water up to 15° from the vertical Geschützt gegen Tropfwasser, das in einem Winkel von 15° zur Senkrechten fällt	06		impact 1 joule Schlag 1 joule
3		protected against solid objects over 2,5 mm (tools + small wires) Geschützt gegen feste Objekte über 2,5 mm (Werkzeuge und kleine Drähte)	3		protected against sprays to 60° from the vertical Geschützt gegen Sprühwasser, das in einem Winkel von 60° zur Senkrechten fällt	07		impact 2 joule Schlag 2 joule
4		protected against solid objects over 1 mm (tools + small wires) Geschützt gegen feste Objekte über 1 mm (Werkzeuge und kleine Drähte)	4		protected against water sprayed from all directions – limited ingress permitted Geschützt gegen Spritzwasser aus allen Richtungen - geringes Eindringen gestattet	08		impact 5 joule Schlag 5 joule
5		protected against dust – limited ingress permitted (no harmful deposit.) Geschützt gegen begrenztes Eindringen von Staub (Staub-ablagerungen ohne schädigende Wirkung)	5		protected against low pressure jets of water from all directions – limited ingress permitted Geschützt gegen Strahlwasser mit geringem Druck - geringes Eindringen gestattet	09		impact 10 joule Schlag 10 joule
6		totally protected against dust Völlig staubgeschützt	6		protected against strong jets of water e.g. for use on shipdecks – limited ingress permitted Geschützt gegen starkes Strahlwasser, z.B. für den Einsatz auf Schiffdecks - geringes Eindringen gestattet	10		impact 20 joule Schlag 20 joule
7			7		protected against the effects of immersion between 15 cm and 1 m permitted Geschützt gegen vorübergehendes Untertauchen in eine Tiefe zwischen 15 cm und 1 m			
8			8		protected against long periods of immersion under pressure Geschützt gegen dauerndes Untertauchen unter Druck			

DOOR

- Door opening angle 120°
- Left/ right turning option
- Pre-formed fixing studs inside
- Easy access to the contents
- Door stop available Patent pending hinge design
- Easy assembly and refined appearance

TÜR, SCHWENKBAR

- Öffnungswinkel 120°
- Türanschlag links/ rechts montierbar
- Vorgeformte Montagedomes
- Einfacher Zugang zu montierten Bauteilen
- Türfeststeller *

PATENT HINGE DESIGN

- Easy assembly and refined appearance

SCHARNIERDESIGN

- Einfach zu montieren
- Ansprechendes Design



DECLINED DESIGN ON BASE

- Better waterproof

ABGESCHRÄGTES UNTERTEILDESIGN

- Besserer Regenschutz



The main body of the Fibox ARCA cabinet is made from rugged polycarbonate which offers many benefits:

- Non corrosive
- High impact resistance
- Low maintenance
- UV resistant
- Aesthetically pleasing

Der ARCA Wanschaltschrank ist aus robustem Polycarbonat gefertigt und bietet viele Vorteile:

- Korrosionsbeständig
- Hohe Schlagfestigkeit
- Annähernd Wartungsfrei
- UV resistent
- Ansprechendes Design

MOUNTING PODS

- On the base, cover and four base sides Declined design on base
- Better waterproof

MONTAGEDOME

- Im Unterteil auf dem Boden und allen vier Seiten
- in der Tür

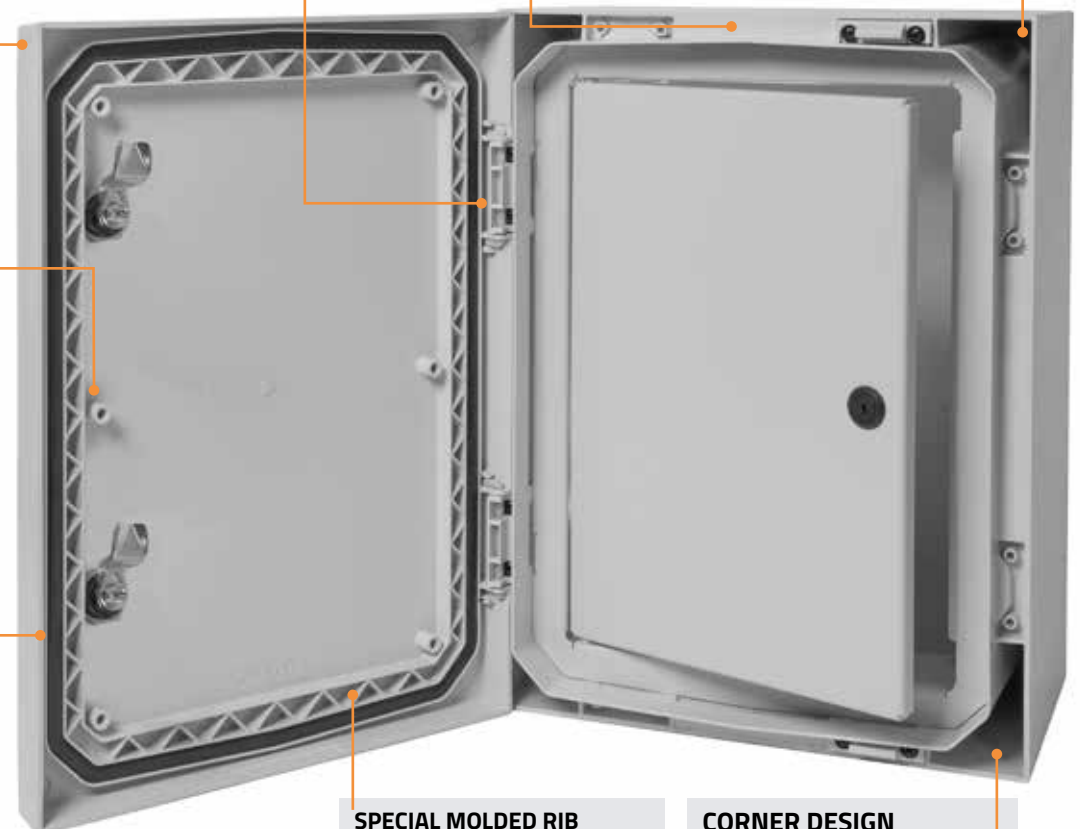

GASKET

- Wide and secured gasket with PUR material for high quality sealing.

DICHTUNG

- Breite und geführte PUR Dichtung gewährleistet hohe Dichtigkeit

SWING HANDLE

- Secure 2-point closing with swing handle
- Changeable lock inserts



SCHWENKHEBEL

- Sicherer 2-Punkt-Verschluss mit Schwenkhebel
- Wechseleinsätze



DOOR GUIDE

- Secure closing

TÜRFÜHRUNG

- Sichere Türschließung

WINDOW DOOR TÜR MIT SICHTFENSTER

SPECIAL MOLDED RIB DESIGN

- For making the cabinet extra stabile and solid

SPEZIELL GEFORMTES RIPPENDESIGN

- Um der Tür zusätzliche Stabilität zu geben



CORNER DESIGN

- Double corner to secure fixing without destroying the IP/IK
- Robust and rigid cabinet

ECKDESIGN

- Doppelwandige Eckausführung zur Absicherung der IP / IK -Schutzart
- Robuste und stabile Ausführung





MOUNTING PLATE

- Galvanized steel as standard
- Resin bonded paper board and perforated galvanized steel on request

MONTAGEPLATTEN

- Stahl, verzinkt (Standard)
- Hardpapier, isoliert*
- Gelocht, Telequick *
- Gelocht, multigelocht *



INNER DOOR (IDS) *

- No tools needed for installation
- Lockable
- Patent pending

INNENTÜR (IDS)*

- Montage ohne Werkzeuge möglich
- Abschließbar



LOCKING (LIS+CLI)*

- Double-bit
- Changeable lock inserts

VERSCHLÜSSE (LIS+CLI)*

- Doppelbartverschluß (Standard)
- Weitere Schlosseinsätze*



DIN RAIL FRAME SET (DRS) *

- Including DIN rail frame, front plate, corner brackets and screws for installation
- Easy and quick installation
- Patent pending

MONTAGERAHMEN FÜR REIHNEINBAUGERÄTE (DRS)*

- Montagerahmen inklusiv Abdeckplatte, Eckprofilen und Montageschrauben
- Schnelle und einfache Montage



WALL MOUNTING LUGS (WMK) *

- 2 depths (10 and 40 mm) in stainless 316 steel

WANDBEFESTIGUNGSLASCHEN (WMK)*

- 2 Höhen, 10 und 40 mm Wandabstand, Edelstahl 316



RAIN CANOPY SET (RCS)*

REGENSCHUTZKANTEN SET (RCS)



ADJUSTABLE MOUNTING PLATE (CBS) *

- Easy to assemble the mountingplate to desired depth with special corner brackets

MONTAGEPLATTE, HÖHENVERSTELLBAR (CBS)*

- Einfache und schnelle Montage auf der gewünschten Höhe durch spezielle Eckstücke



PLASTIC WALL MOUNTING LUGS SET (WMKQ)*

- Adds 10 and 50 mm between wall and cabinet

KUNSTSTOFF WANDBEFESTIGUNGSLASCHEN SET (WMKQ)*

- 2 Höhen 10 und 50 mm Wandabstand
- Einfache Installation von außen montierbar



DOOR STOPPER (DSP)

TÜRFESTSTELLER (DSP)*





- Horizontale oder vertikale Ausführungen
- Links- oder Rechtsanschlag

*Accessory sold separately | *Zubehör separat zu beziehen

	ORDER SYMBOL BESTELLZEICHEN	CODE ARTIKEL-NR.	EAN	DESCRIPTION BESCHREIBUNG
	MPS ARCA 3020	8120731		MOUNTING PLATE (250x150 mm), Galvanized steel MONTAGEPLATTE (250x150 mm), Stahl, verzinkt
	MPP ARCA 2030	8120930		MOUNTING PLATE PERFORATED (250x150 mm - 26x11 mm), Galvanized steel MONTAGEPLATTE, GELOCHT, TELEQUICK (250x150 mm - 26x11 mm), Stahl, verzinkt
	MPMP ARCA 3020	8120920		MOUNTING PLATE MULTIPERFORATED (250x150 mm - ø3.6 mm), Galvanized steel MONTAGEPLATTE, MULTIGELOCHT (250x150 mm - ø3.6 mm), Stahl, verzinkt
	MPX ARCA 3020	8120741		MOUNTING PLATE (250x150 mm), Resin bonded paper board MONTAGEPLATTE (250x150 mm) Hardpapier, isoliert
	DRS ARCA 203015	8120791		DIN RAIL FRAME SET 1 row x 11 modules MONTAGERAHMEN F. REIHENEINBAUGERÄTE, (SET) 1-reihig, 11 Module
	IDS ARCA 2030	8120910		INNER DOOR SET Galvanized steel, RAL 7035 INNENTÜR (SET) Stahl, verzinkt, lackiert RAL 7035
	PMK ARCA 30	8120841		POLE MOUNTING KIT for pole ø100-300 mm MASTBEFESTIGUNG, (SET) Mast ø100-300 mm
	RCS ARCA 2030	8120940		RAIN CANOPY SET REGENSCHUTZKANTE FÜR 2030

ARCA IEC 200 x 300 x 150 mm (H x W x D)



ORDER SYMBOL BESTELLZEICHEN	CODE ARTIKEL-NR.	EAN	DESCRIPTION BESCHREIBUNG
ARCA 203015	8120020	 6 418074 079312	1-POINT LOCKING 1-PUNKT SCHLIESSUNG
ARCA 203015W	8120140	 6 418074 080110	COVER WITH WINDOW, 1-POINT LOCKING SICHTTÜR, 1-PUNKT SCHLIESSUNG
ARCA 203015 NO MP	8120020N	 6 418074 089403	1-POINT LOCKING, NO MOUNTINGPLATE 1-PUNKT SCHLIESSUNG, KEINE MONTAGEPLATTE
ARCA 203015W NO MP	8120140N	 6 418074 094193	COVER WITH WINDOW, 1-POINT LOCKING, NO MOUNTINGPLATE SICHTTÜR, 1-PUNKT SCHLIESSUNG, KEINE MONTAGEPLATTE

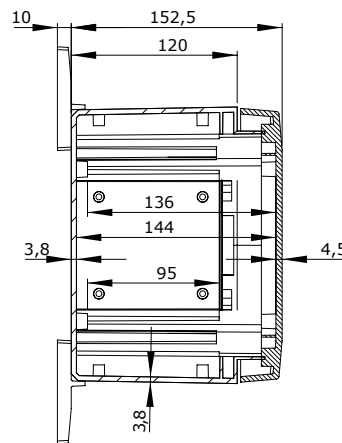
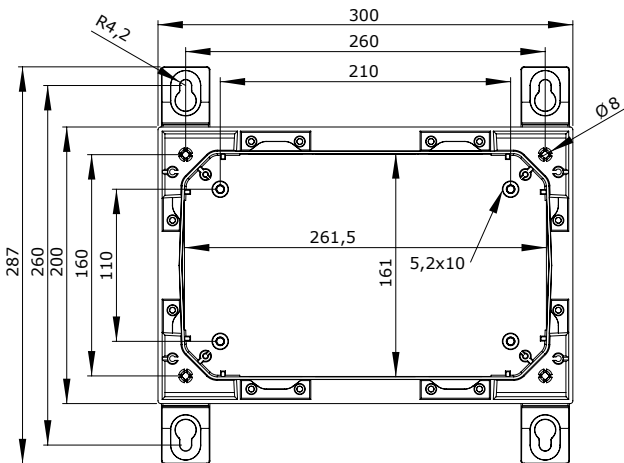



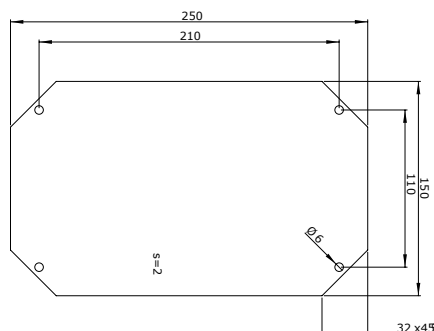
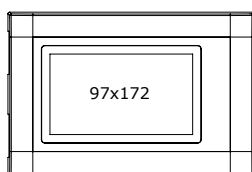

2030W



	ORDER SYMBOL BESTELLZEICHEN	CODE ARTIKEL-NR.	EAN	DESCRIPTION BESCHREIBUNG
	MPS ARCA 3020	8120731		MOUNTING PLATE (250x150 mm), Galvanized steel MONTAGEPLATTE (250x150 mm) , Stahl, verzinkt
	MPP ARCA 3020	8120751		MOUNTING PLATE PERFORATED (250x150 mm - 26x11 mm), Galvanized steel MONTAGEPLATTE, GELOCHT, TELEQUICK (250x150 mm - 26x11 mm) Stahl, verzinkt
	MPMP ARCA 3020	8120920		MOUNTING PLATE MULTIPERFORATED (250x150 mm - ø3.6 mm) Galvanized steel MONTAGEPLATTE, MULTIGELOCHT (250x150 mm - ø3.6 mm) Stahl, verzinkt
	MPX ARCA 3020	8120741		MOUNTING PLATE (250x150 mm) Resin bonded paper board MONTAGEPLATTE (250x150 mm) Hardpapier, isoliert
	DRS ARCA 302015	8120760		DIN RAIL FRAME SET 1 row x 5 modules MONTAGERAHMEN F. REIHENEINBAUGERÄTE (SET) 1-reihig, 5 Module
	IDS ARCA 3020	8120711		INNER DOOR SET Galvanized steel, RAL 7035 INNENTÜR (SET) Stahl, verzinkt, lackiert RAL 7035
	PMK ARCA 20	8120840		POLE MOUNTING KIT for pole ø100-300 mm MASTBEFESTIGUNG (SET) Mast ø100-300 mm
	RCS ARCA 3020	8120941		RAIN CANOPY SET REGENSCHUTZKANTE FÜR 3020

ARCA IEC 300 x 200 x 150 mm (H x W x D)



ORDER SYMBOL BESTELLZEICHEN	CODE ARTIKEL-NR.	EAN	DESCRIPTION BESCHREIBUNG
ARCA 302015	8120002	 6 418074 079138	1-POINT LOCKING 1-PUNKT SCHLIESSUNG
ARCA 302015W	8120122	 6 418074 079916	COVER WITH WINDOW, 1-POINT LOCKING SICHTTÜR, 1-PUNKT SCHLIESSUNG
ARCA 302015 NO MP	8120002N	 6 418074 089335	1-POINT LOCKING, NO MOUNTING PLATE 1-PUNKT SCHLIESSUNG, KEINE MONTAGEPLATTE
ARCA 302015W NO MP	8120122N	 6 418074 093981	COVER WITH WINDOW, 1-POINT LOCKING, NO MOUNTING PLATE SICHTTÜR, 1-PUNKT SCHLIESSUNG, KEINE MONTAGEPLATTE





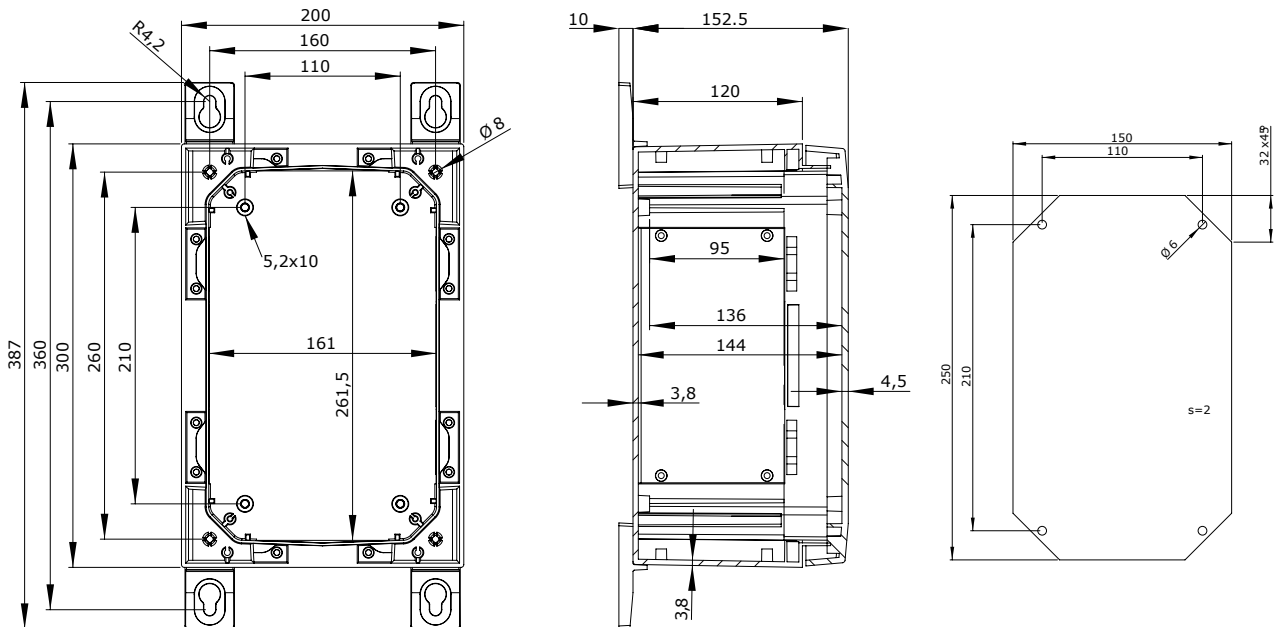



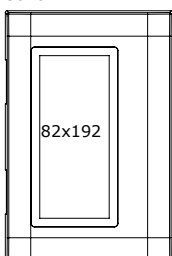









Cabinet base, door with PUR gasket, mounting plate, screws for mounting plate. 3 mm double bit lock(s) with key.

Schaltschrankunterteil, Tür mit PUR-Dichtung, Montageplatte (Stahl, verz.), Montageschrauben. 3 mm Doppelbartvorreiber mit Schlüssel.







3020W



	ORDER SYMBOL BESTELLZEICHEN	CODE ARTIKEL-NR.	EAN	DESCRIPTION BESCHREIBUNG
	MPS ARCA 3030	8120732		MOUNTING PLATE (250x250 mm), Galvanized steel MONTAGEPLATTE (250x250 mm), Stahl, verzinkt
	MPP ARCA 3030	8120752		MOUNTING PLATE PERFORATED (250x250 mm - 26x11 mm), Galvanized steel MONTAGEPLATTE, GELOCHT, TELEQUICK (250x250 mm - 26x11 mm) Stahl, verzinkt
	MPMP ARCA 3030	8120921		MOUNTING PLATE MULTIPERFORATED (250x250 mm - ø3.6 mm), Galvanized steel MONTAGEPLATTE, MULTIGELOCHT (250x250 mm - ø3.6 mm) Stahl, verzinkt
	MPX ARCA 3030	8120742		MOUNTING PLATE (350x250 mm), Resin bonded paper board MONTAGEPLATTE (350x250 mm) Hardpapier, isoliert
	DRS ARCA 303021	8120763		DIN RAIL FRAME SET 2 rows x 11 modules MONTAGERAHMEN F. REIHENEINBAUGERÄTE, (SET) 2-reihig, je 11 Module
	IDS ARCA 3030	8120712		INNER DOOR SET Galvanized steel, RAL 7035 INNENTÜR (SET) Stahl, verzinkt, lackiert RAL 7035
	PMK ARCA 30	8120841		POLE MOUNTING KIT for pole ø100-300 mm MASTBEFESTIGUNG, (SET) Mast ø100-300 mm
	RCS ARCA 4030	8120943		RAIN CANOPY SET REGENSCHUTZKANTE FÜR 3020
	DSP ARCA HLS	8120962		DOOR STOPPER ARCA horizontal, left, small TÜRFESTSTELLER waagrecht, Anschlag links
	DSP ARCA HRS	8120963		DOOR STOPPER ARCA horizontal, right, small TÜRFESTSTELLER waagrecht, Anschlag rechts

ARCA IEC 300 x 300 x 210 mm (H x W x D)



ORDER SYMBOL BESTELLZEICHEN	CODE ARTIKEL-NR.	EAN	DESCRIPTION BESCHREIBUNG
ARCA 303021	8120005		2-POINT LOCKING 2-PUNKT SCHLIESSUNG
ARCA 303021W	8120125		COVER WITH WINDOW, 2-POINT LOCKING SICHTTÜR, 2-PUNKT SCHLIESSUNG
ARCA 303021 NO MP	8120005N		2-POINT LOCKING, NO MOUNTING PLATE 2-PUNKT SCHLIESSUNG, KEINE MONTAGEPLATTE
ARCA 303021W NO MP	8120125N		COVER WITH WINDOW, 2-POINT LOCKING, NO MOUNTING PLATE SICHTTÜR, 2-PUNKT SCHLIESSUNG, KEINE MONTAGEPLATTE

Cabinet base, door with PUR gasket, mounting plate, screws for mounting plate. 3 mm double bit lock(s) with key.



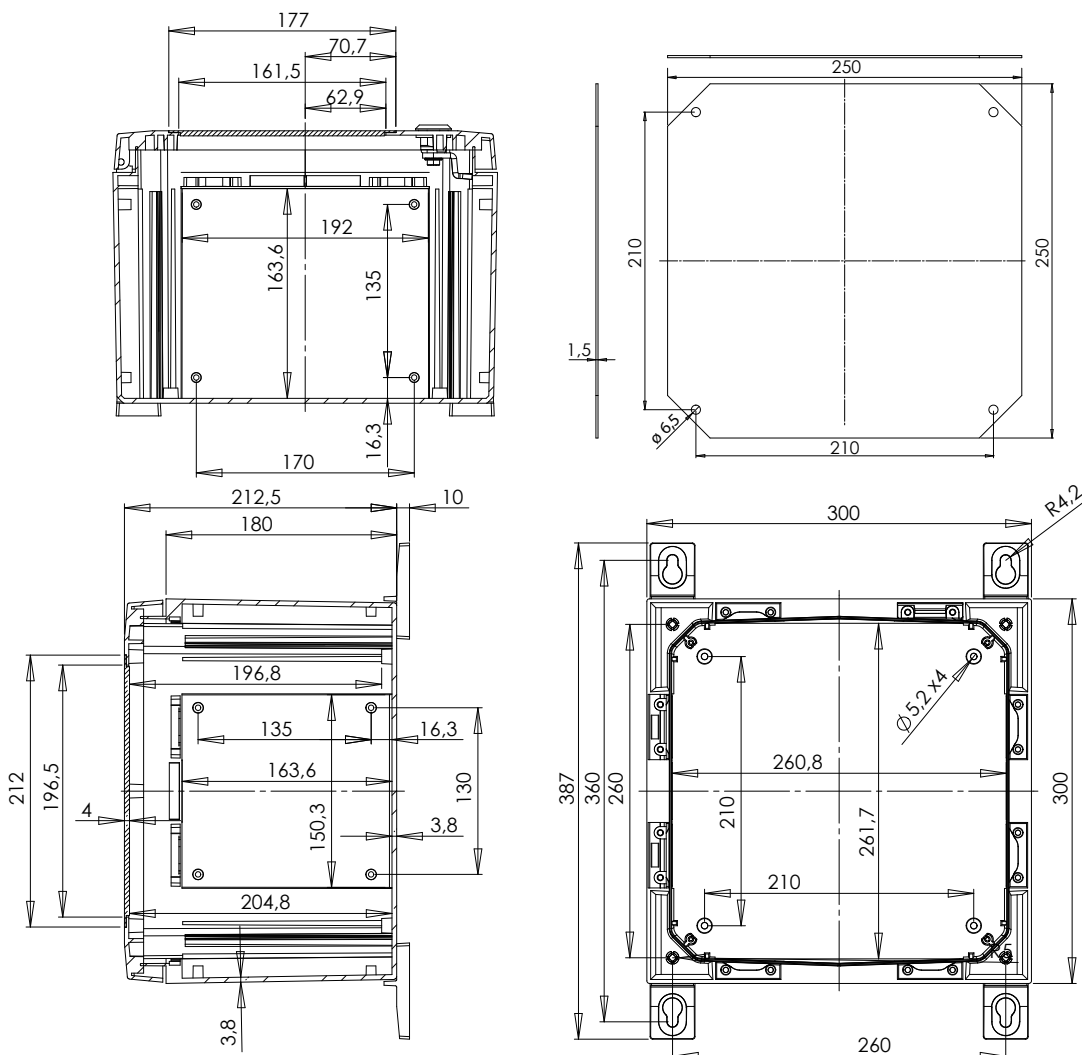

Schaltschrankunterteil, Tür mit PUR-Dichtung, Montageplatte (Stahl, verz.), Montageschrauben. 3 mm Doppelbarvorreiber mit Schlüssel.



	ORDER SYMBOL BESTELLZEICHEN	CODE ARTIKEL-NR.	EAN	DESCRIPTION BESCHREIBUNG
	MPS ARCA 4030	8120733		MOUNTING PLATE (350x250 mm), Galvanized steel MONTAGEPLATTE (350x250 mm) Stahl, verzinkt
	MPP ARCA 3040	8120931		MOUNTING PLATE PERFORATED (350x250 mm - 26x11 mm), Galvanized steel MONTAGEPLATTE, GELOCHT, TELEQUICK (350x250 mm - 26x11 mm) Stahl, verzinkt
	MPMP ARCA 4030	8120922		MOUNTING PLATE MULTIPERFORATED (350x250 mm - ø3.6 mm), Galvanized steel MONTAGEPLATTE, MULTIGELOCHT (350x250 mm - ø3.6 mm), Stahl, verzinkt
	MPX ARCA 4030	8120743		MOUNTING PLATE (350x250 mm), Resin bonded paper board MONTAGEPLATTE (350x250 mm) Hardpapier, isoliert
	DRS ARCA 304015	8120793		DIN RAIL FRAME SET 1 row x 16 modules MONTAGERAHMEN F. REIHENEINBAUGERÄTE, (Set) 1-reihig, 16 Module
	IDS ARCA 3040	8120911		INNER DOOR SET Galvanized steel, RAL 7035 INNENTÜR (SET) Stahl, verzinkt, lackiert RAL 7035
	PMK ARCA 40	8120842		POLE MOUNTING KIT for pole ø100-300 mm MASTBEFESTIGUNG, (SET) Mast ø100-300 mm
	RCS ARCA 3040	8120942		RAIN CANOPY SET REGENSCHUTZKANTE FÜR 3040
	DSP ARCA HLS	8120962		DOOR STOPPER ARCA horizontal, left, small TÜRFESTSTELLER waagrecht, Anschlag links
	DSP ARCA HRS	8120963		DOOR STOPPER ARCA horizontal, right, small TÜRFESTSTELLER waagrecht, Anschlag rechts

ARCA IEC 300 x 400 x 150 mm (H x W x D)



ORDER SYMBOL BESTELLZEICHEN	CODE ARTIKEL-NR.	EAN	DESCRIPTION BESCHREIBUNG
ARCA 304015	8120022	 6 418074 079336	2-POINT LOCKING 2-PUNKT SCHLIESSUNG
ARCA 304015W	8120142	 6 418074 080134	COVER WITH WINDOW, 2-POINT LOCKING SICHTTÜR, 1-PUNKT SCHLIESSUNG
ARCA 304015 NO MP	8120022N	 6 418074 089410	2-POINT LOCKING, NO MOUNTINGPLATE 2-PUNKT SCHLIESSUNG, KEINE MONTAGEPLATTE
ARCA 304015W NO MP	8120142N	 6 418074 094209	COVER WITH WINDOW, 2-POINT LOCKING, NO MOUNTINGPLATE SICHTTÜR, 1-PUNKT SCHLIESSUNG, KEINE MONTAGEPLATTE

Cabinet base, door with PUR gasket, mounting plate, screws for mounting plate. 3 mm double bit lock(s) with key.

Schaltschrankunterteil, Tür mit PUR-Dichtung, Montageplatte (Stahl, verz.), Montageschrauben. 3 mm Doppelbartvorreiber mit Schlüssel.

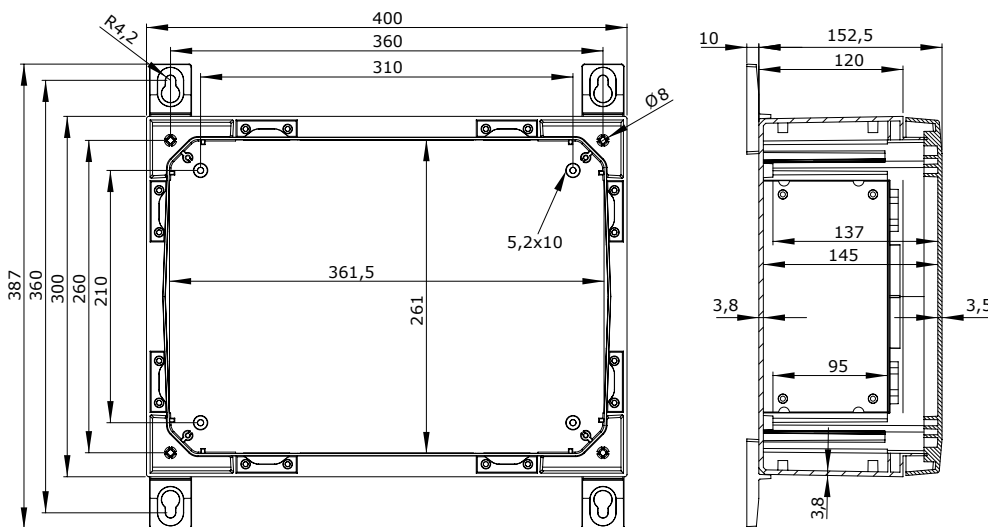



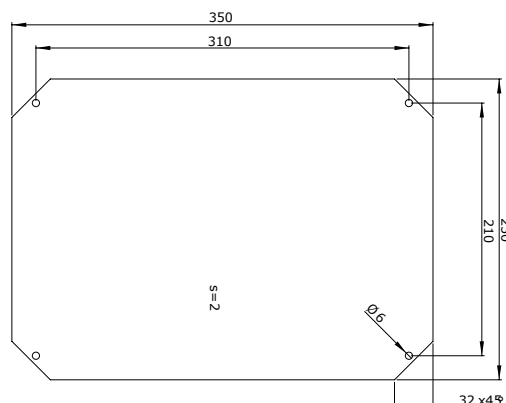
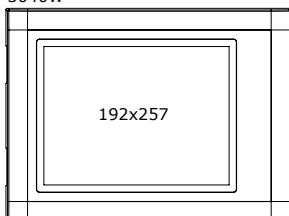

3040W



	ORDER SYMBOL BESTELLZEICHEN	CODE ARTIKEL-NR.	EAN	DESCRIPTION BESCHREIBUNG
	MPS ARCA 4030	8120733		MOUNTING PLATE (350x250 mm), Galvanized steel MONTAGEPLATTE (350x250 mm), Stahl, verzinkt
	MPP ARCA 3040	8120931		MOUNTING PLATE PERFORATED (350x250 mm - 26x11 mm), Galvanized steel MONTAGEPLATTE, GELOCHT, TELEQUICK (350x250 mm - 26x11 mm) Stahl, verzinkt
	MPMP ARCA 4030	8120922		MOUNTING PLATE MULTIPERFORATED (350x250 mm - ø3.6 mm) Galvanized steel MONTAGEPLATTE, MULTIGELOCHT (350x250 mm - ø3.6 mm) Stahl, verzinkt
	MPX ARCA 4030	8120743		MOUNTING PLATE (350x250 mm) Resin bonded paper board MONTAGEPLATTE (350x250 mm) Hardpapier, isoliert
	DRS ARCA 304021	8120794		DIN RAIL FRAME SET 1 row x 16 modules MONTAGERAHMEN F. REIHENEINBAUGERÄTE, (SET) 1-reihig, 16 Module
	IDS ARCA 3040	8120911		INNER DOOR SET Galvanized steel, RAL 7035 INNENTÜR (SET) Stahl, verzinkt, lackiert RAL 7035
	PMK ARCA 40	8120842		POLE MOUNTING KIT for pole ø100-300 mm MASTBEFESTIGUNG, (SET) Mast ø100-300 mm
	RCS ARCA 3040	8120942		RAIN CANOPY SET REGENSCHUTZKANTE FÜR 3040
	DSP ARCA HLS	8120962		DOOR STOPPER ARCA horizontal, left, small TÜRFESTSTELLER waagerecht, Anschlag links
	DSP ARCA HRS	8120963		DOOR STOPPER ARCA horizontal, right, small TÜRFESTSTELLER waagerecht, Anschlag rechts

ARCA IEC 300 x 400 x 210 mm (H x W x D)









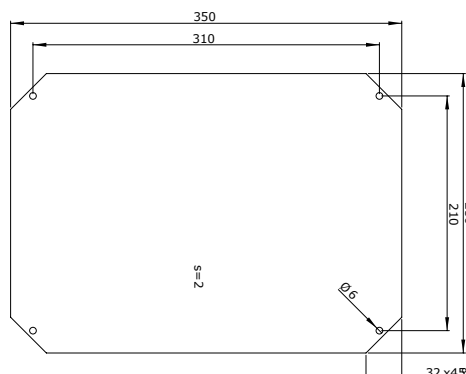
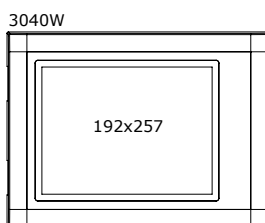
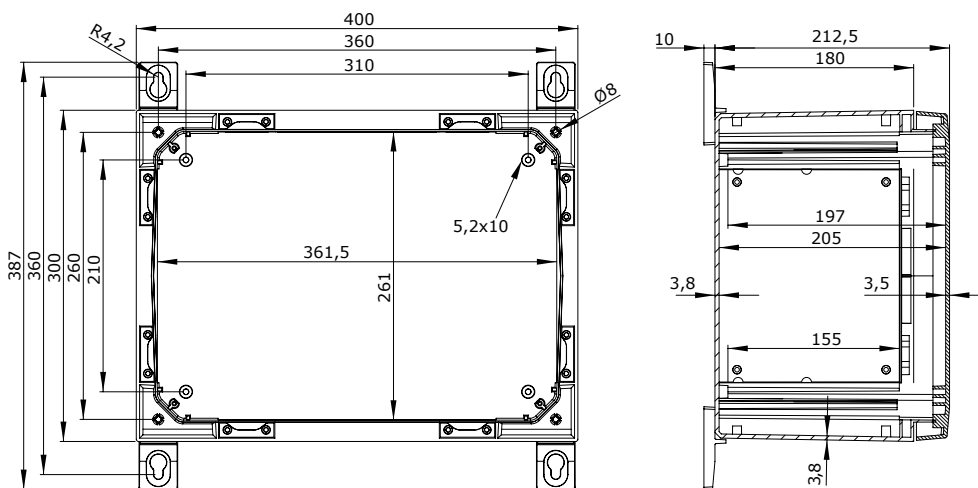





ORDER SYMBOL BESTELLZEICHEN	CODE ARTIKEL-NR.	EAN	DESCRIPTION BESCHREIBUNG
ARCA 304021	8120023	 6 418074 079343	2-POINT LOCKING 2-PUNKT SCHLIESSUNG
ARCA 304021W	8120143	 6 418074 080141	COVER WITH WINDOW, 2-POINT LOCKING SICHTTÜR, 1-PUNKT SCHLIESSUNG
ARCA 304021 NO MP	8120023N	 6 418074 089427	2-POINT LOCKING, NO MOUNTINGPLATE 2-PUNKT SCHLIESSUNG, KEINE MONTAGEPLATTE
ARCA 304021W NO MP	8120143N	 6 418074 094216	COVER WITH WINDOW, 2-POINT LOCKING, NO MOUNTINGPLATE SICHTTÜR, 1-PUNKT SCHLIESSUNG, KEINE MONTAGEPLATTE







Cabinet base, door with PUR gasket, mounting plate, screws for mounting plate. 3 mm double bit lock(s) with key.

Schaltschrankunterteil, Tür mit PUR-Dichtung, Montageplatte (Stahl, verz.), Montageschrauben. 3 mm Doppelbartvorreiber mit Schlüssel.



	ORDER SYMBOL BESTELLZEICHEN	CODE ARTIKEL-NR.	EAN	DESCRIPTION BESCHREIBUNG
	MPS ARCA 4030	8120733		MOUNTING PLATE (350x250 mm), Galvanized steel MONTAGEPLATTE (350x250 mm), Stahl, verzinkt
	MPP ARCA 4030	8120753		MOUNTING PLATE PERFORATED (350x250 mm - 26x11 mm), Galvanized steel MONTAGEPLATTE, GELOCHT, TELEQUICK (350x250 mm - 26x11 mm) Stahl, verzinkt
	MPMP ARCA 4030	8120922		MOUNTING PLATE MULTIPERFORATED (350x250 mm - ø3.6 mm) Galvanized steel MONTAGEPLATTE, MULTIGELOCHT (350x250 mm - ø3.6 mm) Stahl, verzinkt
	MPX ARCA 4030	8120743		MOUNTING PLATE (350x250 mm) Resin bonded paper board MONTAGEPLATTE (350x250 mm) Hardpapier, isoliert
	DRS ARCA 403015	8120764		DIN RAIL FRAME SET 2 rows x 11 modules MONTAGERAHMEN F. REIHENEINBAUGERÄTE, (SET) 2-reihig, je 11 Module
	IDS ARCA 4030	8120713		INNER DOOR SET Galvanized steel, RAL 7035 INNENTÜR (SET) Stahl, verzinkt, lackiert RAL 7035
	PMK ARCA 30	8120841		POLE MOUNTING KIT for pole ø100-300 mm MASTBEFESTIGUNG, (SET) Mast ø100-300 mm
	RCS ARCA 4030	8120943		RAIN CANOPY SET REGENSCHUTZKANTE FÜR 4030
	DSP ARCA VLS	8120960		DOOR STOPPER ARCA vertical, left, small TÜRFESTSTELLER senkrecht, Anschlag links
	DSP ARCA VRS	8120961		DOOR STOPPER ARCA vertical, right, small TÜRFESTSTELLER senkrecht, Anschlag rechts









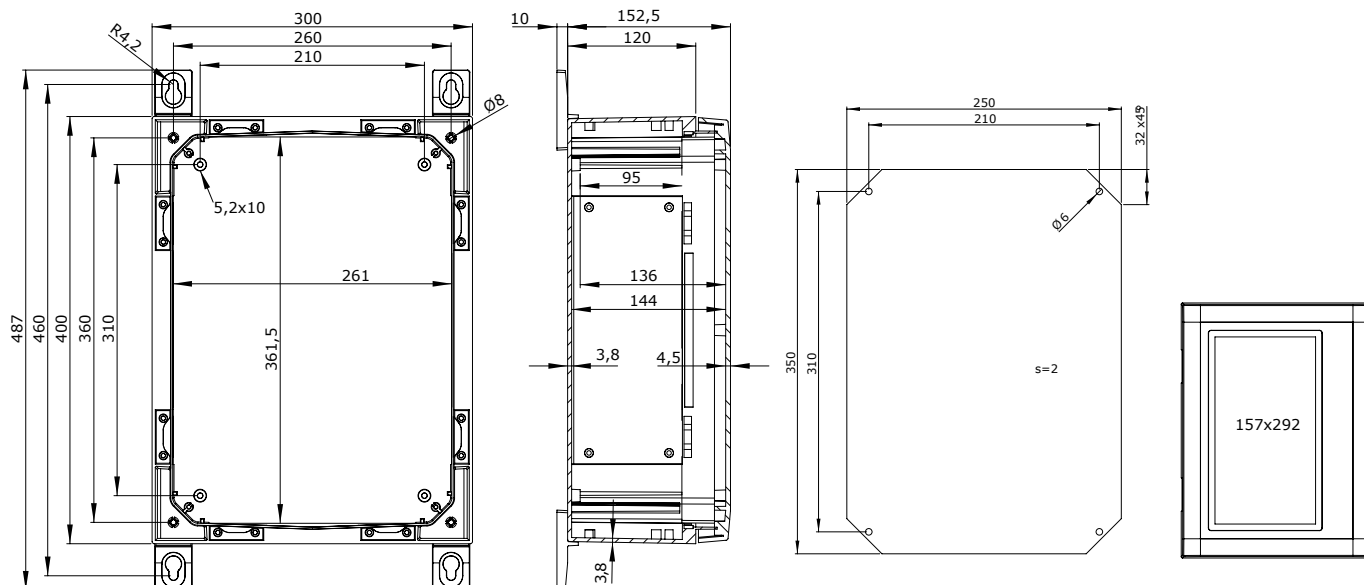



ORDER SYMBOL BESTELLZEICHEN	CODE ARTIKEL-NR.	EAN	DESCRIPTION BESCHREIBUNG
ARCA 403015	8120006	 6 418074 079176	2-POINT LOCKING 2-PUNKT SCHLIESSUNG
ARCA 403015S	8120086	 6 418074 079695	SWINGHANDLE SCHWENKHEBEL
ARCA 403015W	8120126	 6 418074 079954	COVER WITH WINDOW, 2-POINT LOCKING SICHTTÜR, 2-PUNKT SCHLIESSUNG
ARCA 403015 NO MP	8120006N	 6 418074 089342	2-POINT LOCKING, NO MOUNTINGPLATE 2-PUNKT SCHLIESSUNG, KEINE MONTAGEPLATTE
ARCA 403015S NO MP	8120086N	 6 418074 094971	SWINGHANDLE, NO MOUNTINGPLATE SCHWENKHEBEL, KEINE MONTAGEPLATTE
ARCA 403015W NO MP	8120126N	 6 418074 093998	COVER WITH WINDOW, 2-POINT LOCKING, NO MOUNTINGPLATE SICHTTÜR, 2-PUNKT SCHLIESSUNG, KEINE MONTAGEPLATTE

Cabinet base, door with PUR gasket, mounting plate, screws for mounting plate. 3 mm double bit lock(s) with key. 5 versions with swinghandle 2-point locking system. Door guide included.







Schaltschrankunterteil, Tür mit PUR-Dichtung, Montageplatte (Stahl, verz.), Montageschrauben. 3 mm Doppelbartvorreiber mit Schlüssel. 5 Version mit 2-Punktverschluss und Schwenkhebel. Türführung integriert.



ARCA IEC ACCESSORIES – ZUBEHÖR

	ORDER SYMBOL BESTELLZEICHEN	CODE ARTIKEL-NR.	EAN	DESCRIPTION BESCHREIBUNG
	MPS ARCA 4030	8120733		MOUNTING PLATE (350x250 mm), Galvanized steel MONTAGEPLATTE (350x250 mm), Stahl, verzinkt
	MPP ARCA 4030	8120753		MOUNTING PLATE PERFORATED (350x250 mm - 26x11 mm), Galvanized steel MONTAGEPLATTE, GELOCHT, TELEQUICK (350x250 mm - 26x11 mm) Stahl, verzinkt
	MPMP ARCA 4030	8120922		MOUNTING PLATE MULTIPERFORATED (350x250 mm - ø3.6 mm), Galvanized steel MONTAGEPLATTE, MULTIGELOCHT (350x250 mm - ø3.6 mm) Stahl, verzinkt
	MPX ARCA 4030	8120743		MOUNTING PLATE (350x250 mm) Resin bonded paper board MONTAGEPLATTE (350x250 mm) Hardpapier, isoliert
	DRS ARCA 403021	8120765		DIN RAIL FRAME SET 2 rows x 11 modules MONTAGERAHMEN F. REIHENEINBAUGERÄTE, (SET) 2-reihig, je 11 Module
	IDS ARCA 4030	8120713		INNER DOOR SET Galvanized steel, RAL 7035 INNENTÜR (SET) Stahl, verzinkt, lackiert RAL 7035
	PMK ARCA 30	8120841		POLE MOUNTING KIT for pole ø100-300 mm MASTBEFESTIGUNG, (SET) Mast ø100-300 mm
	RCS ARCA 4030	8120943		RAIN CANOPY SET REGENSCHUTZKANTE FÜR 4030
	DSP ARCA VLS	8120960		DOOR STOPPER ARCA vertical, left, small TÜRFESTSTELLER senkrecht, Anschlag links
	DSP ARCA VRS	8120961		DOOR STOPPER ARCA vertical, right, small TÜRFESTSTELLER senkrecht, Anschlag rechts









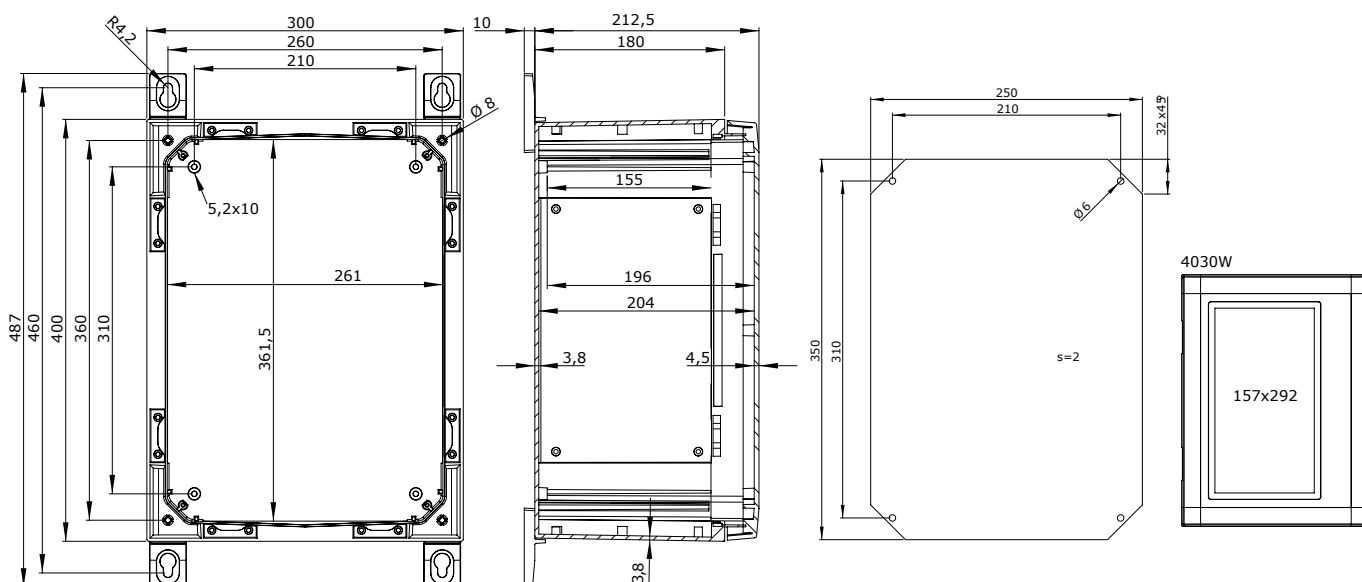











ORDER SYMBOL BESTELLZEICHEN	CODE ARTIKEL-NR.	EAN	DESCRIPTION BESCHREIBUNG
ARCA 403021	8120007	 6 418074 079183	2-POINT LOCKING 2-PUNKT SCHLIESSUNG
ARCA 403021S	8120087	 6 418074 079701	SWINGHANDLE SCHWENKHEBEL
ARCA 403021W	8120127	 6 418074 079961	COVER WITH WINDOW, 2-POINT LOCKING SICHTTÜR, 2-PUNKT SCHLIESSUNG
ARCA 403021 NO MP	8120007N	 6 418074 089359	2-POINT LOCKING, NO MOUNTINGPLATE 2-PUNKT SCHLIESSUNG, KEINE MONTAGEPLATTE
ARCA 403021S NO MP	8120087N	 6 418074 094988	SWINGHANDLE, NO MOUNTINGPLATE SCHWENKHEBEL, KEINE MONTAGEPLATTE
ARCA 403021W NO MP	8120127N	 6 418074 094001	COVER WITH WINDOW, 2-POINT LOCKING, NO MOUNTINGPLATE SICHTTÜR, 2-PUNKT SCHLIESSUNG, KEINE MONTAGEPLATTE

Cabinet base, door with PUR gasket, mounting plate, screws for mounting plate. 3 mm double bit lock(s) with key. 5 versions with swinghandle 2-point locking system. Door guide included.

Schaltschrankunterteil, Tür mit PUR-Dichtung, Montageplatte (Stahl, verz.), Montageschrauben. 3 mm Doppelbartvorreiber mit Schlüssel. 5 Version mit 2-Punktverschluss und Schwenkhebel. Türführung integriert.



	ORDER SYMBOL BESTELLZEICHEN	CODE ARTIKEL-NR.	EAN	DESCRIPTION BESCHREIBUNG
	MPS ARCA 4040	8120734		MOUNTING PLATE (350x350 mm), Galvanized steel MONTAGEPLATTE (350x350 mm), Stahl, verzinkt
	MPP ARCA 4040	8120754		MOUNTING PLATE PERFORATED (350x350 mm - 26x11 mm), Galvanized steel MONTAGEPLATTE, GELOCHT, TELEQUICK (350x350 mm - 26x11 mm) Stahl, verzinkt
	MPMP ARCA 4040	8120923		MOUNTING PLATE MULTIPERFORATED (350x350 mm - ø3.6 mm), Galvanized steel MONTAGEPLATTE, MULTIGELOCHT (350x350 mm - ø3.6 mm) Stahl, verzinkt
	MPX ARCA 4040	8120744		MOUNTING PLATE (350x350 mm) Resin bonded paper board MONTAGEPLATTE (350x250 mm) Hardpapier, isoliert
	DRS ARCA 404021	8120767		DIN RAIL FRAME SET 2 rows x 17 modules MONTAGERAHMEN F. REIHENEINBAUGERÄTE, (SET) 2-reihig, je 17 Module
	IDS ARCA 4040	8120714		INNER DOOR SET Galvanized steel, RAL 7035 INNENTÜR (SET) Stahl, verzinkt, lackiert RAL 7035
	PMK ARCA 40	8120842		POLE MOUNTING KIT for pole ø100-300 mm MASTBEFESTIGUNG, (SET) Mast ø100-300 mm
	RCS ARCA 5040	8120946		RAIN CANOPY SET REGENSCHUTZKANTE FÜR 4030
	DSP ARCA HLS	8120962		DOOR STOPPER ARCA horizontal, left, small TÜRFESTSTELLER waagrecht, Anschlag links
	DSP ARCA HRS	8120963		DOOR STOPPER ARCA horizontal, right, small TÜRFESTSTELLER waagrecht, Anschlag rechts

ARCA IEC 400 x 400 x 210 mm (H x W x D)









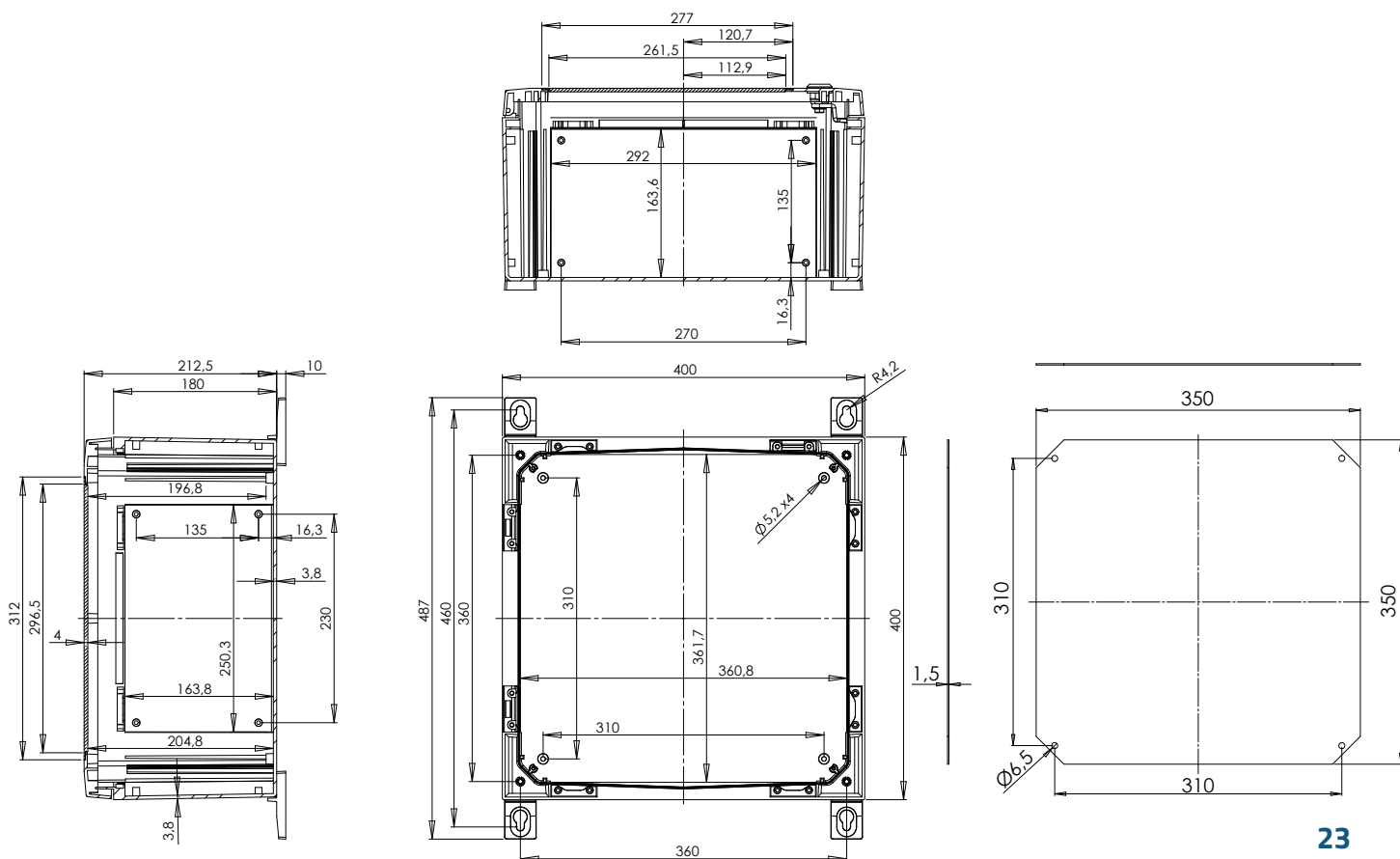









ORDER SYMBOL BESTELLZEICHEN	CODE ARTIKEL-NR.	EAN	DESCRIPTION BESCHREIBUNG
ARCA 404021	8120009		2-POINT LOCKING 2-PUNKT SCHLIESSUNG
ARCA 404021S	8120089		SWINGHANDLE SCHWENKHEBEL
ARCA 404021W	8120129		COVER WITH WINDOW, 2-POINT LOCKING SICHTTÜR, 2-PUNKT SCHLIESSUNG
ARCA 404021 NO MP	8120009N		2-POINT LOCKING, NO MOUNTINGPLATE 2-PUNKT SCHLIESSUNG, KEINE MONTAGEPLATTE
ARCA 404021S NO MP	8120089N		SWINGHANDLE, NO MOUNTINGPLATE SCHWENKHEBEL, KEINE MONTAGEPLATTE
ARCA 404021W NO MP	8120129N		COVER WITH WINDOW, 2-POINT LOCKING, NO MOUNTINGPLATE SICHTTÜR, 2-PUNKT SCHLIESSUNG, KEINE MONTAGEPLATTE

Cabinet base, door with PUR gasket, mounting plate, screws for mounting plate. 3 mm double bit lock(s) with key. 5 versions with swinghandle 2-point locking system. Door guide included.







Schaltschrankunterteil, Tür mit PUR-Dichtung, Montageplatte (Stahl, verz.), Montageschrauben. 3 mm Doppelbartvorreiber mit Schlüssel. 5 Version mit 2-Punktverschluss und Schwenkhebel. Türführung integriert.



	ORDER SYMBOL BESTELLZEICHEN	CODE ARTIKEL-NR.	EAN	DESCRIPTION BESCHREIBUNG
	MPS ARCA 5040	8120735		MOUNTING PLATE (450x350 mm), Galvanized steel MONTAGEPLATTE (450x350 mm), Stahl, verzinkt
	MPP ARCA 4050	8120932		MOUNTING PLATE PERFORATED (450x350 mm - 26x11 mm), Galvanized steel MONTAGEPLATTE, GELOCHT, TELEQUICK (450x350 mm - 26x11 mm) Stahl, verzinkt
	MPMP ARCA 5040	8120924		MOUNTING PLATE MULTIPERFORATED (450x350 mm - ø3.6 mm), Galvanized steel MONTAGEPLATTE, MULTIGELOCHT (450x350 mm - ø3.6 mm) Stahl, verzinkt
	MPX ARCA 5040	8120745		MOUNTING PLATE (450x350 mm) Resin bonded paper board MONTAGEPLATTE (450x350 mm) Hardpapier, isoliert
	DRS ARCA 405021	8120796		DIN RAIL FRAME SET 2 rows x 22 modules MONTAGERAHMEN F. REIHEN- EINBAUGERÄTE, (SET) 2-reihig, je 22 Module
	IDS ARCA 4050	8120912		INNER DOOR SET Galvanized steel, RAL 7035 INNENTÜR (SET) Stahl, verzinkt, lackiert RAL 7035
	PMK ARCA 50	8120843		POLE MOUNTING KIT for pole ø100-300 mm MASTBEFESTIGUNG, (SET) Mast ø100-300 mm
	RCS ARCA 4050	8120944		RAIN CANOPY SET REGENSCHUTZKANTE FÜR 4050
	DSP ARCA HLS	8120962		DOOR STOPPER ARCA horizontal, left, small TÜRFESTSTELLER waagrecht, Anschlag links
	DSP ARCA HRS	8120963		DOOR STOPPER ARCA horizontal, right, small TÜRFESTSTELLER waagrecht, Anschlag rechts

ARCA IEC 400 x 500 x 210 mm (H x W x D)









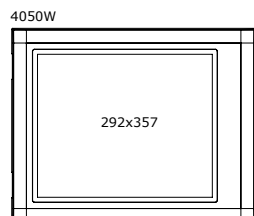
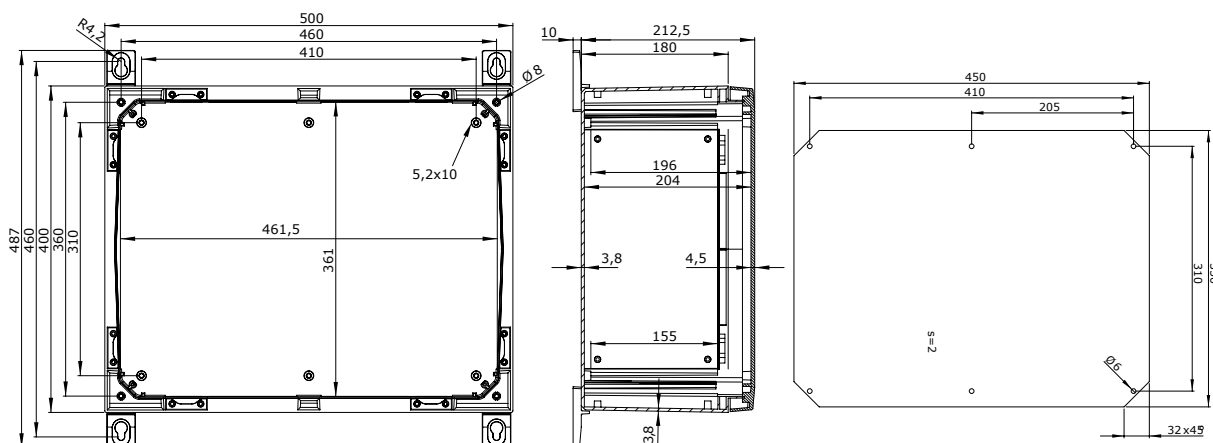





ORDER SYMBOL BESTELLZEICHEN	CODE ARTIKEL-NR.	EAN	DESCRIPTION BESCHREIBUNG
ARCA 405021	8120025	 6 418074 079367	2-POINT LOCKING 2-PUNKT SCHLIESSUNG
ARCA 403021S	8120105	 6 418074 079886	SWINGHANDLE SCHWENKHEBEL
ARCA 403021W	8120145	 6 418074 080165	COVER WITH WINDOW, 2-POINT LOCKING SICHTTÜR, 2-PUNKT SCHLIESSUNG
ARCA 405021 NO MP	8120025N	 6 418074 089434	2-POINT LOCKING, NO MOUNTINGPLATE 2-PUNKT SCHLIESSUNG, KEINE MONTAGEPLATTE
ARCA 405021S NO MP	8120105N	 6 418074 095060	SWINGHANDLE, NO MOUNTINGPLATE SCHWENKHEBEL, KEINE MONTAGEPLATTE
ARCA 405021W NO MP	8120145N	 6 418074 094223	COVER WITH WINDOW, 2-POINT LOCKING, NO MOUNTINGPLATE SICHTTÜR, 2-PUNKT SCHLIESSUNG, KEINE MONTAGEPLATTE

Cabinet base, door with PUR gasket, mounting plate, screws for mounting plate. 3 mm double bit lock(s) with key. 5 versions with swinghandle 2-point locking system. Door guide included.







Schaltschrankunterteil, Tür mit PUR-Dichtung, Montageplatte (Stahl, verz.), Montageschrauben. 3 mm Doppelbartvorreiber mit Schlüssel. 5 Version mit 2-Punktverschluß und Schwenkhebel. Türführung integriert.



	ORDER SYMBOL BESTELLZEICHEN	CODE ARTIKEL-NR.	EAN	DESCRIPTION BESCHREIBUNG
	MPS ARCA 6040	8120736		MOUNTING PLATE (550x350 mm), Galvanized steel MONTAGEPLATTE (550x350 mm), Stahl, verzinkt
	MPP ARCA 4060	8120933		MOUNTING PLATE PERFORATED (550x350 mm - 26x11 mm), Galvanized steel MONTAGEPLATTE, GELOCHT, TELEQUICK (550x350 mm - 26x11 mm) Stahl, verzinkt
	MPMP ARCA 6040	8120925		MOUNTING PLATE MULTIPERFORATED (550x350 mm - ø3.6 mm), Galvanized steel MONTAGEPLATTE, MULTIGELOCHT (550x350 mm - ø3.6 mm) Stahl, verzinkt
	MPX ARCA 6040	8120746		MOUNTING PLATE (550x350 mm) Resin bonded paper board MONTAGEPLATTE (550x350 mm) Hardpapier, isoliert
	DRS ARCA 406021	8120797		DIN RAIL FRAME SET 2 rows x 27 modules MONTAGERAHMEN F. REIHENEINBAUGERÄTE, (SET) 2-reihig, je 27 Module
	IDS ARCA 4060	8120913		INNER DOOR SET Galvanized steel, RAL 7035 INNENTÜR (SET) Stahl, verzinkt, lackiert RAL 7035
	PMK ARCA 60	8120844		POLE MOUNTING KIT for pole ø100-300 mm MASTBEFESTIGUNG, (SET) Mast ø100-300 mm
	RCS ARCA 4060	8120945		RAIN CANOPY SET REGENSCHUTZKANTE FÜR 4060
	DSP ARCA HLS	8120962		DOOR STOPPER ARCA horizontal, left, small TÜRFESTSTELLER waagrecht, Anschlag links
	DSP ARCA HRS	8120963		DOOR STOPPER ARCA horizontal, right, small TÜRFESTSTELLER waagrecht, Anschlag rechts

ARCA IEC 400 x 600 x 210 mm (H x W x D)



ORDER SYMBOL BESTELLZEICHEN	CODE ARTIKEL-NR.	EAN	DESCRIPTION BESCHREIBUNG
ARCA 406021	8120026		2-POINT LOCKING 2-PUNKT SCHLIESSUNG
ARCA 406021S	8120106		SWINGHANDLE SCHWENKHEBEL
ARCA 406021W	8120146		COVER WITH WINDOW, 2-POINT LOCKING SICHTTÜR, 2-PUNKT SCHLIESSUNG
ARCA 406021 NO MP	8120026N		2-POINT LOCKING, NO MOUNTINGPLATE 2-PUNKT SCHLIESSUNG, KEINE MONTAGEPLATTE
ARCA 406021S NO MP	8120106N		SWINGHANDLE, NO MOUNTINGPLATE SCHWENKHEBEL, KEINE MONTAGEPLATTE
ARCA 406021W NO MP	8120146N		COVER WITH WINDOW, 2-POINT LOCKING, NO MOUNTINGPLATE SICHTTÜR, 2-PUNKT SCHLIESSUNG, KEINE MONTAGEPLATTE



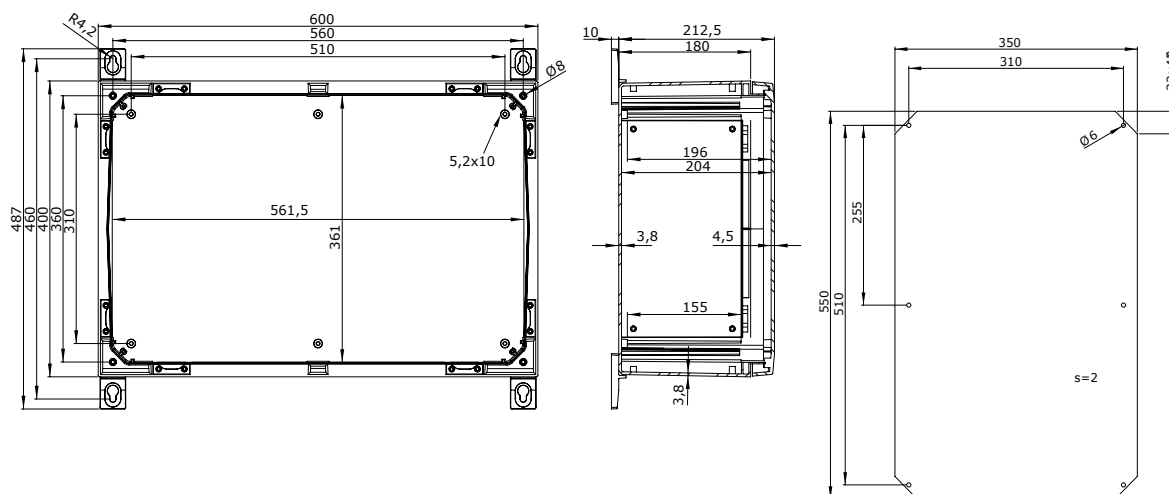

Cabinet base, door with PUR gasket, mounting plate, screws for mounting plate. 3 mm double bit lock(s) with key. 5 versions with swinghandle 2-point locking system. Door guide included.

Schaltschrankunterteil, Tür mit PUR-Dichtung, Montageplatte (Stahl, verz.), Montageschrauben. 3 mm Doppelbartvorreiber mit Schlüssel. 5 Version mit 2-Punktverschluss und Schwenkhebel. Türführung integriert.

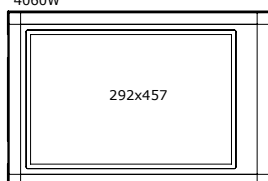







4060W



	ORDER SYMBOL BESTELLZEICHEN	CODE ARTIKEL-NR.	EAN	DESCRIPTION BESCHREIBUNG
	MPS ARCA 5040	8120735		MOUNTING PLATE (450x350 mm) , Galvanized steel MONTAGEPLATTE (450x350 mm), Stahl, verzinkt
	MPP ARCA 5040	8120755		MOUNTING PLATE PERFORATED (450x350 mm - 26x11 mm), Galvanized steel MONTAGEPLATTE, GELOCHT, TELEQUICK (450x350 mm - 26x11 mm) Stahl, verzinkt
	MPMP ARCA 5040	8120924		MOUNTING PLATE MULTIPERFORATED (450x350 mm - ø3.6 mm), Galvanized steel MONTAGEPLATTE, MULTIGELOCHT (450x350 mm - ø3.6 mm) Stahl, verzinkt
	MPX ARCA 5040	8120745		MOUNTING PLATE (450x350 mm) Resin bonded paper board MONTAGEPLATTE (450x350 mm) Hardpapier, isoliert
	DRS ARCA 504021	8120769		DIN RAIL FRAME SET 3 rows x 16 modules MONTAGERAHMEN F. REIHENEINBAUGERÄTE, (SET) 3-reihig, je 16 Module
	IDS ARCA 5040	8120715		INNER DOOR SET Galvanized steel, RAL 7035 INNENTÜR (SET) Stahl, verzinkt, lackiert RAL 7035
	PMK ARCA 40	8120842		POLE MOUNTING KIT for pole ø100-300 mm MASTBEFESTIGUNG, (SET) Mast ø100-300 mm
	RCS ARCA 5040	8120946		RAIN CANOPY SET REGENSCHUTZKANTE FÜR 5040
	DSP ARCA VLS	8120960		DOOR STOPPER ARCA vertical, left, small TÜRFESTSTELLER senkrecht, Anschlag links
	DSP ARCA VRS	8120961		DOOR STOPPER ARCA vertical, right, small TÜRFESTSTELLER senkrecht, Anschlag rechts









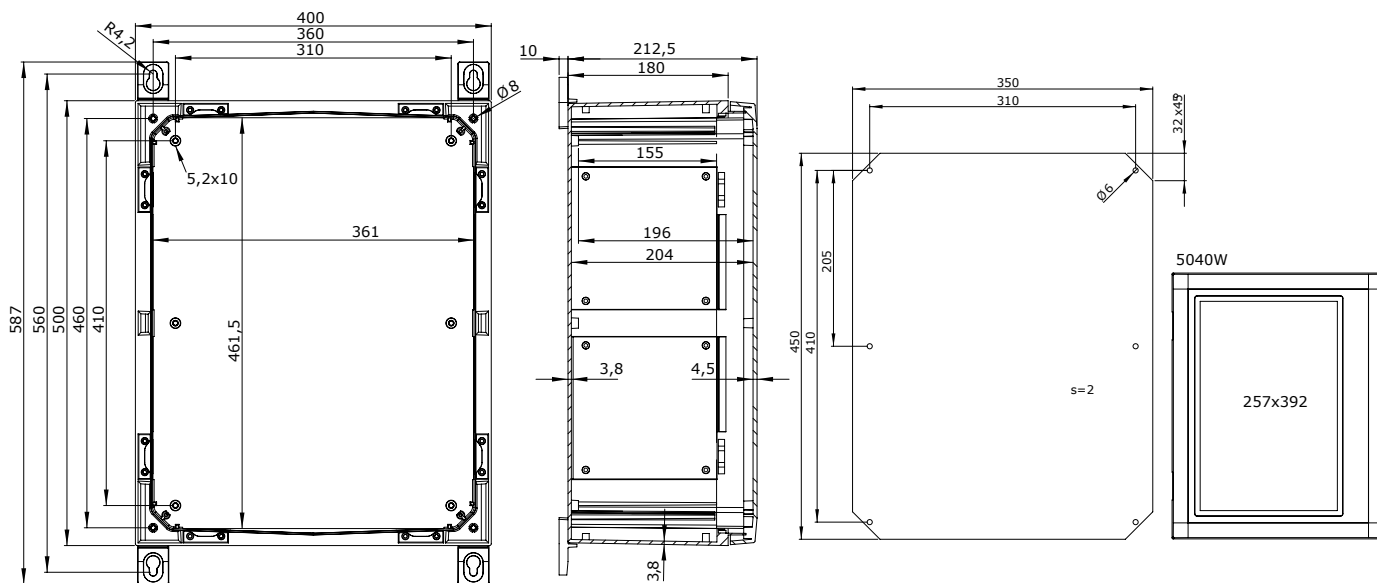











ORDER SYMBOL BESTELLZEICHEN	CODE ARTIKEL-NR.	EAN	DESCRIPTION BESCHREIBUNG
ARCA 504021	8120011	 6 418074 079220	2-POINT LOCKING 2-PUNKT SCHLIESSUNG
ARCA 504021S	8120091	 6 418074 079749	SWINGHANDLE SCHWENKHEBEL
ARCA 504021W	8120131	 6 418074 080028	COVER WITH WINDOW, 2-POINT LOCKING SICHTTÜR, 2-PUNKT SCHLIESSUNG
ARCA 504021 NO MP	8120011N	 6 418074 089366	2-POINT LOCKING, NO MOUNTINGPLATE 2-PUNKT SCHLIESSUNG, KEINE MONTAGEPLATTE
ARCA 504021S NO MP	8120091N	 6 418074 094995	SWINGHANDLE, NO MOUNTINGPLATE SCHWENKHEBEL, KEINE MONTAGEPLATTE
ARCA 504021W NO MP	8120131N	 6 418074 094018	COVER WITH WINDOW, 2-POINT LOCKING, NO MOUNTINGPLATE SICHTTÜR, 2-PUNKT SCHLIESSUNG, KEINE MONTAGEPLATTE

Cabinet base, door with PUR gasket, mounting plate, screws for mounting plate. 3 mm double bit lock(s) with key. 5 versions with swinghandle 2-point locking system. Door guide included.





Schaltschrankunterteil, Tür mit PUR-Dichtung, Montageplatte (Stahl, verz.), Montageschrauben. 3 mm Doppelbartvorreiber mit Schlüssel. 5 Version mit 2-Punktverschluß und Schwenkhebel. Türführung integriert.



	ORDER SYMBOL BESTELLZEICHEN	CODE ARTIKEL-NR.	EAN	DESCRIPTION BESCHREIBUNG
	MPS ARCA 5050	8120730		MOUNTING PLATE (450x450 mm), Galvanized steel MONTAGEPLATTE (450x450 mm), Stahl, verzinkt
	MPP ARCA 5050	8120750		MOUNTING PLATE PERFORATED (450x450 mm - 26x11 mm), Galvanized steel MONTAGEPLATTE, GELOCHT, TELEQUICK (450x450 mm - 26x11 mm) Stahl, verzinkt
	MPMP ARCA 5050	8120929		MOUNTING PLATE MULTIPERFORATED (450x450 mm - ø3.6 mm), Galvanized steel MONTAGEPLATTE, MULTIGELOCHT (450x450 mm - ø3.6 mm) Stahl, verzinkt
	MPX ARCA 5050	8120740		MOUNTING PLATE (450x450 mm) Resin bonded paper board MONTAGEPLATTE (450x450 mm) Hardpapier, isoliert
	DRS ARCA 505021	8120778		DIN RAIL FRAME SET 3 rows x 22 modules MONTAGERAHMEN F. REIHENEINBAUGERÄTE, (SET) 3-reihig, je 22 Module
	IDS ARCA 5050	8120710		INNER DOOR SET Galvanized steel, RAL 7035 INNENTÜR (SET) Stahl, verzinkt, lackiert RAL 7035
	PMK ARCA 50	8120843		POLE MOUNTING KIT for pole ø100-300 mm MASTBEFESTIGUNG, (SET) Mast ø100-300 mm
	RCS ARCA 5050	8120954		RAIN CANOPY SET REGENSCHUTZKANTE FÜR 5050
	DSP ARCA HLS	8120962		DOOR STOPPER ARCA horizontal, left, small TÜRFESTSTELLER waagrecht, Anschlag links
	DSP ARCA HRS	8120963		DOOR STOPPER ARCA horizontal, right, small TÜRFESTSTELLER waagrecht, Anschlag rechts

ARCA IEC 500 x 500 x 210 mm (H x W x D)



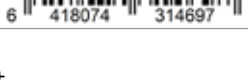



ORDER SYMBOL BESTELLZEICHEN	CODE ARTIKEL-NR.	EAN	DESCRIPTION BESCHREIBUNG
ARCA 505021	8120032		2-POINT LOCKING 2-PUNKT SCHLIESSUNG
ARCA 505021S	8120112		SWINGHANDLE SCHWENKHEBEL
ARCA 505021W	8120152		COVER WITH WINDOW, 2-POINT LOCKING SICHTTÜR, 2-PUNKT SCHLIESSUNG
ARCA 505021 NO MP	8120032N		2-POINT LOCKING, NO MOUNTINGPLATE 2-PUNKT SCHLIESSUNG, KEINE MONTAGEPLATTE
ARCA 505021S NO MP	8120112N		SWINGHANDLE, NO MOUNTINGPLATE SCHWENKHEBEL, KEINE MONTAGEPLATTE
ARCA 505021W NO MP	8120152N		COVER WITH WINDOW, 2-POINT LOCKING, NO MOUNTINGPLATE SICHTTÜR, 2-PUNKT SCHLIESSUNG, KEINE MONTAGEPLATTE

Cabinet base, door with PUR gasket, mounting plate, screws for mounting plate. 3 mm double bit lock(s) with key.

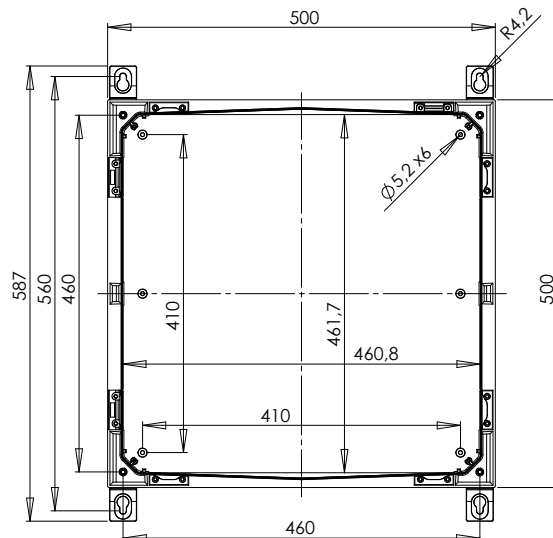
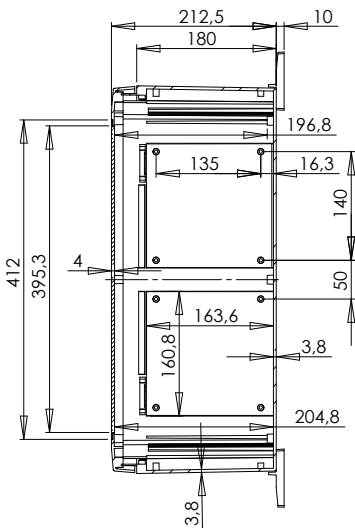
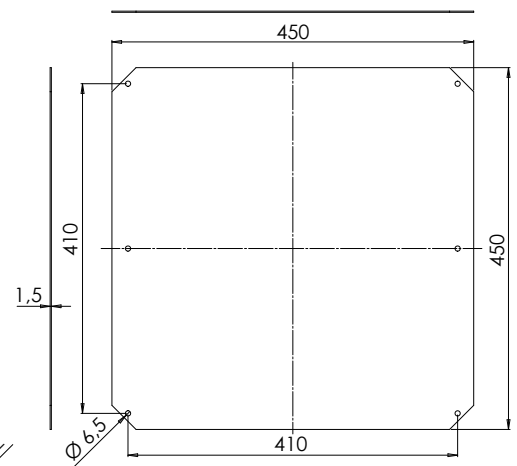
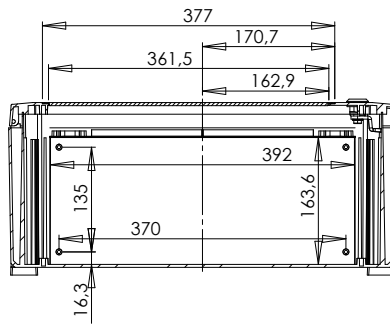
5 versions with swinghandle 2-point locking system. Door guide included.

Schaltschrankunterteil, Tür mit PUR-Dichtung, Montageplatte (Stahl, verz.), Montageschrauben. 3 mm Doppelbartvorreiber mit Schlüssel. 5 Version mit 2-Punktverschluss und Schwenkhebel. Türführung integriert.



	ORDER SYMBOL BESTELLZEICHEN	CODE ARTIKEL-NR.	EAN	DESCRIPTION BESCHREIBUNG
	MPS ARCA 7050	8120738		MOUNTING PLATE (630x430 mm), Galvanized steel MONTAGEPLATTE (630x430 mm), Stahl, verzinkt
	MPP ARCA 5070	8120934		MOUNTING PLATE PERFORATED (630x430 mm - 26x11 mm), Galvanized steel MONTAGEPLATTE, GELOCHT, TELEQUICK (630x430 mm - 26x11 mm) Stahl, verzinkt
	MPMP ARCA 7050	8120927		MOUNTING PLATE MULTIPERFORATED (630x430 mm - ø3.6 mm), Galvanized steel MONTAGEPLATTE, MULTIGELOCHT (630x430 mm - ø3.6 mm) Stahl, verzinkt
	MPX ARCA 7050	8120748		MOUNTING PLATE (630x430 mm) Resin bonded paper board MONTAGEPLATTE (630x430 mm) Hardpapier, isoliert
	DRS ARCA 507030	8120790		DIN RAIL FRAME SET 3 rows x 32 modules MONTAGERAHMEN F. REIHENEINBAUGERÄTE, (SET) 3-reihig, je 32 Module
	IDS ARCA 5070	8120914		INNER DOOR SET Galvanized steel, RAL 7035 INNENTÜR (SET) Stahl, verzinkt, lackiert RAL 7035
	PMK ARCA 70	8120845		POLE MOUNTING KIT for pole ø100-300 mm MASTBEFESTIGUNG, (SET) Mast ø100-300 mm
	RCS ARCA 5070	8120947		RAIN CANOPY SET REGENSCHUTZKANTE FÜR 5070
	DSP ARCA LM	8120964		DOOR STOPPER ARCA left, midsize, for 5070-8060 TÜRFESTSTELLER Anschlag links, midsize für 5070-8060
	DSP ARCA RM	8120965		DOOR STOPPER ARCA right, midsize, for 5070-8060 TÜRFESTSTELLER Anschlag rechts, midsize für 5070-8060

ARCA IEC 500 x 700 x 300 mm (H x W x D)









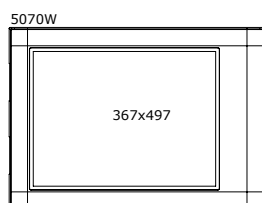
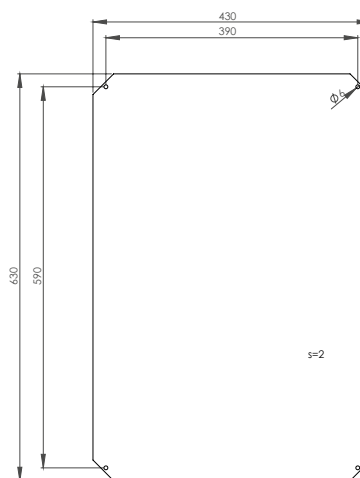
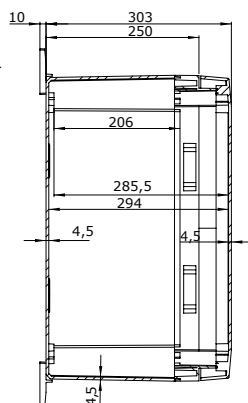
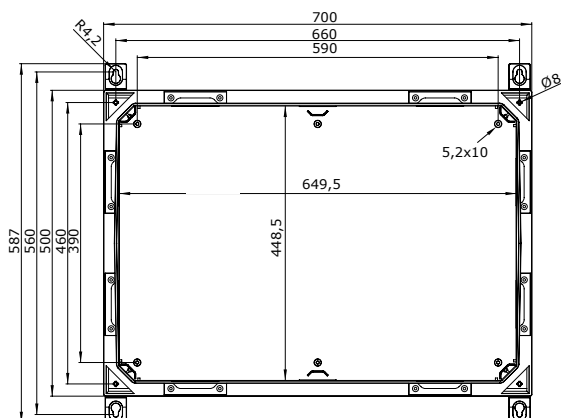









ORDER SYMBOL BESTELLZEICHEN	CODE ARTIKEL-NR.	EAN	DESCRIPTION BESCHREIBUNG
ARCA 507030	8120031	6 418074 086006	2-POINT LOCKING 2-PUNKT SCHLIESSUNG
ARCA 507030S	8120111	6 418074 086044	SWINGHANDLE SCHWENKHEBEL
ARCA 507030W	8120151	6 418074 086068	COVER WITH WINDOW, 2-POINT LOCKING SICHTTÜR, 2-PUNKT SCHLIESSUNG
ARCA 507030 NO MP	8120031N	6 418074 089458	2-POINT LOCKING, NO MOUNTINGPLATE 2-PUNKT SCHLIESSUNG, KEINE MONTAGEPLATTE
ARCA 507030S NO MP	8120111N	6 418074 095091	SWINGHANDLE, NO MOUNTINGPLATE SCHWENKHEBEL, KEINE MONTAGEPLATTE
ARCA 507030W NO MP	8120151N	6 418074 094254	COVER WITH WINDOW, 2-POINT LOCKING, NO MOUNTINGPLATE SICHTTÜR, 2-PUNKT SCHLIESSUNG, KEINE MONTAGEPLATTE

Cabinet base, door with PUR gasket, mounting plate, screws for mounting plate. 3 mm double bit lock(s) with key. 5 versions with swinghandle 2-point locking system. Door guide included.

Schaltschrankunterteil, Tür mit PUR-Dichtung, Montageplatte (Stahl, verz.), Montageschrauben. 3 mm Doppelbartvorreiber mit Schlüssel. 5 Version mit 2-Punktverschluß und Schwenkhebel. Türführung integriert.







	ORDER SYMBOL BESTELLZEICHEN	CODE ARTIKEL-NR.	EAN	DESCRIPTION BESCHREIBUNG
	MPS ARCA 6040	8120736		MOUNTING PLATE (550x350 mm), Galvanized steel MONTAGEPLATTE (550x350 mm), Stahl, verzinkt
	MPP ARCA 6040	8120756		MOUNTING PLATE PERFORATED (550x350 mm - 26x11 mm), Galvanized steel MONTAGEPLATTE, GELOCHT, TELEQUICK (550x350 mm - 26x11 mm) Stahl, verzinkt
	MPMP ARCA 6040	8120925		MOUNTING PLATE MULTIPERFORATED (550x350 mm - ø3.6 mm), Galvanized steel MONTAGEPLATTE, MULTIGELOCHT (550x350 mm - ø3.6 mm) Stahl, verzinkt
	MPX ARCA 6040	8120746		MOUNTING PLATE (550x350 mm) Resin bonded paper board MONTAGEPLATTE (550x350 mm) Hardpapier, isoliert
	DRS ARCA 604021	8120770		DIN RAIL FRAME SET 3 rows x 16 modules MONTAGERAHMEN F. REIHENEINBAUGERÄTE, (SET) 3-reihig, je 16 Module
	IDS ARCA 6040	8120716		INNER DOOR SET Galvanized steel, RAL 7035 INNENTÜR (SET) Stahl, verzinkt, lackiert RAL 7035
	PMK ARCA 40	8120842		POLE MOUNTING KIT for pole ø100-300 mm MASTBEFESTIGUNG, (SET) Mast ø100-300 mm
	RCS ARCA 6040	8120948		RAIN CANOPY SET REGENSCHUTZKANTE FÜR 6040
	DSP ARCA VLS	8120960		DOOR STOPPER ARCA vertical, left, small TÜRFESTSTELLER senkrecht, Anschlag links
	DSP ARCA VRS	8120961		DOOR STOPPER ARCA vertical, right, small TÜRFESTSTELLER senkrecht, Anschlag rechts

ARCA IEC

600 x 400 x 210 mm (H x W x D)



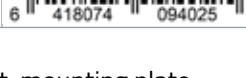





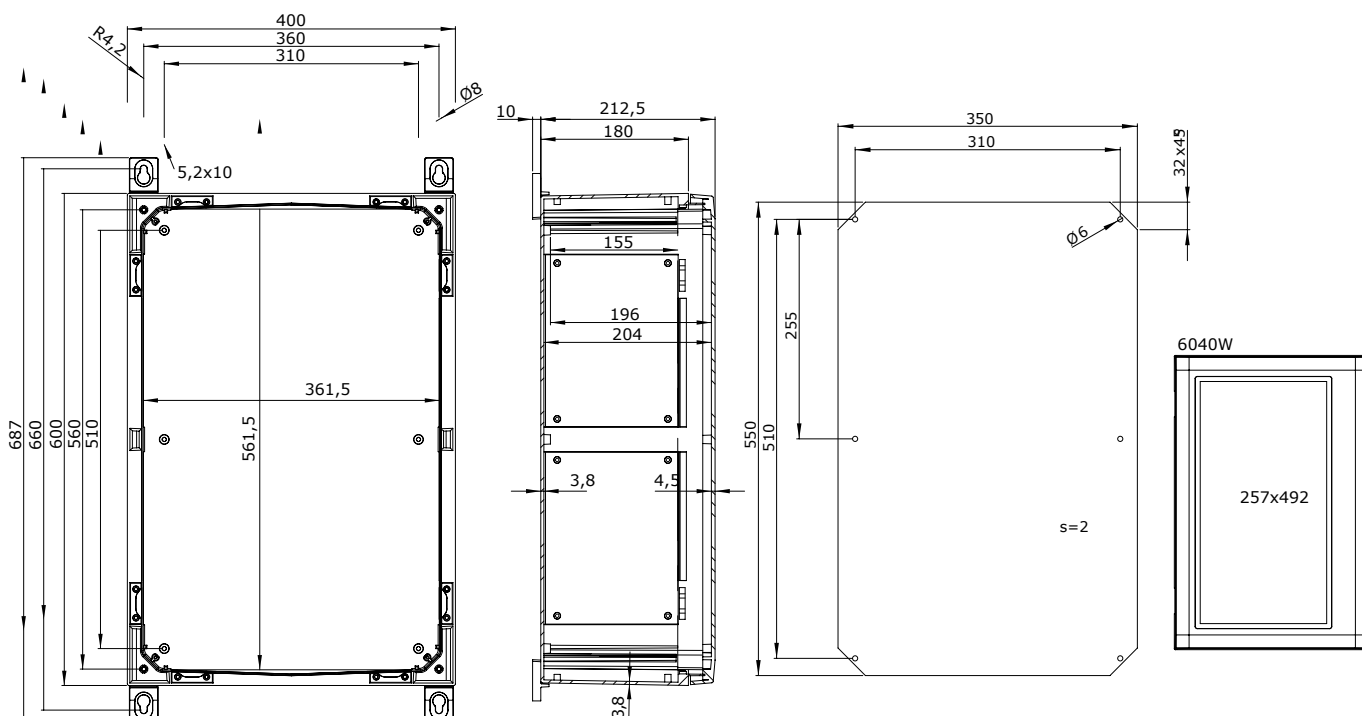





ORDER SYMBOL BESTELLZEICHEN	CODE ARTIKEL-NR.	EAN	DESCRIPTION BESCHREIBUNG
ARCA 604021	8120012		2-POINT LOCKING 2-PUNKT SCHLIESSUNG
ARCA 604021S	8120092		SWINGHANDLE SCHWENKHEBEL
ARCA 604021W	8120132		COVER WITH WINDOW, 2-POINT LOCKING SICHTTÜR, 2-PUNKT SCHLIESSUNG
ARCA 604021 NO MP	8120012N		2-POINT LOCKING, NO MOUNTINGPLATE 2-PUNKT SCHLIESSUNG, KEINE MONTAGEPLATTE
ARCA 604021S NO MP	8120092N		SWINGHANDLE, NO MOUNTINGPLATE SCHWENKHEBEL, KEINE MONTAGEPLATTE
ARCA 604021W NO MP	8120132N		COVER WITH WINDOW, 2-POINT LOCKING, NO MOUNTINGPLATE SICHTTÜR, 2-PUNKT SCHLIESSUNG, KEINE MONTAGEPLATTE

Cabinet base, door with PUR gasket, mounting plate, screws for mounting plate. 3 mm double bit lock(s) with key. 5 versions with swinghandle 2-point locking system. Door guide included.





Schaltschrankunterteil, Tür mit PUR-Dichtung, Montageplatte (Stahl, verz.), Montageschrauben. 3 mm Doppelbartvorreiber mit Schlüssel. 5 Version mit 2-Punktverschluss und Schwenkhebel. Türführung integriert.



	ORDER SYMBOL BESTELLZEICHEN	CODE ARTIKEL-NR.	EAN	DESCRIPTION BESCHREIBUNG
	MPS ARCA 8060	8120739		MOUNTING PLATE (730x530 mm), Galvanized steel MONTAGEPLATTE (730x530 mm), Stahl, verzinkt
	MPP ARCA 6080	8120935		MOUNTING PLATE PERFORATED (730x530 mm - 26x11 mm), Galvanized steel MONTAGEPLATTE, GELOCHT, TELEQUICK (730x530 mm - 26x11 mm) Stahl, verzinkt
	MPMP ARCA 8060	8120928		MOUNTING PLATE MULTIPERFORATED (730x530 mm - ø3.6 mm), Galvanized steel MONTAGEPLATTE, MULTIGELOCHT (730x530 mm - ø3.6 mm) Stahl, verzinkt
	MPX ARCA 8060	8120749		MOUNTING PLATE (730x530 mm) Resin bonded paper board MONTAGEPLATTE (730x530 mm) Hardpapier, isoliert
	DRS ARCA 608030	8120800		DIN RAIL FRAME SET 3 rows x 37 modules MONTAGERAHMEN F. REIHEN- EINBAUGERÄTE, (SET) 3-reihig, je 37 Module
	IDS ARCA 6080	8120915		INNER DOOR SET Galvanized steel, RAL 7035 INNENTÜR (SET) Stahl, verzinkt, lackiert RAL 7035
	PMK ARCA 80	8120846		POLE MOUNTING KIT for pole ø100-300 mm MASTBEFESTIGUNG, (SET) Mast ø100-300 mm
	RCS ARCA 6080	8120949		RAIN CANOPY SET REGENSCHUTZKANTE FÜR 6080
	DSP ARCA LM	8120964		DOOR STOPPER ARCA left, midsize, for 5070-8060 TÜRFESTSTELLER Anschlag links, midsize, für 5070-8060
	DSP ARCA RM	8120965		DOOR STOPPER ARCA right, midsize, for 5070-8060 TÜRFESTSTELLER Anschlag rechts, midsize für 5070-8060

ARCA IEC 600 x 800 x 300 mm (H x W x D)

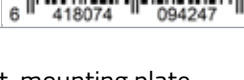

ORDER SYMBOL BESTELLZEICHEN	CODE ARTIKEL-NR.	EAN	DESCRIPTION BESCHREIBUNG
ARCA 608030	8120029		2-POINT LOCKING 2-PUNKT SCHLIESSUNG
ARCA 608030S	8120109		SWINGHANDLE SCHWENKHEBEL
ARCA 608030W	8120149		COVER WITH WINDOW, 2-POINT LOCKING SICHTTÜR, 2-PUNKT SCHLIESSUNG
ARCA 608030 NO MP	8120029N		2-POINT LOCKING, NO MOUNTINGPLATE 2-PUNKT SCHLIESSUNG, KEINE MONTAGEPLATTE
ARCA 608030S NO MP	8120109N		SWINGHANDLE, NO MOUNTINGPLATE SCHWENKHEBEL, KEINE MONTAGEPLATTE
ARCA 608030W NO MP	8120149N		COVER WITH WINDOW, 2-POINT LOCKING, NO MOUNTINGPLATE SICHTTÜR, 2-PUNKT SCHLIESSUNG, KEINE MONTAGEPLATTE



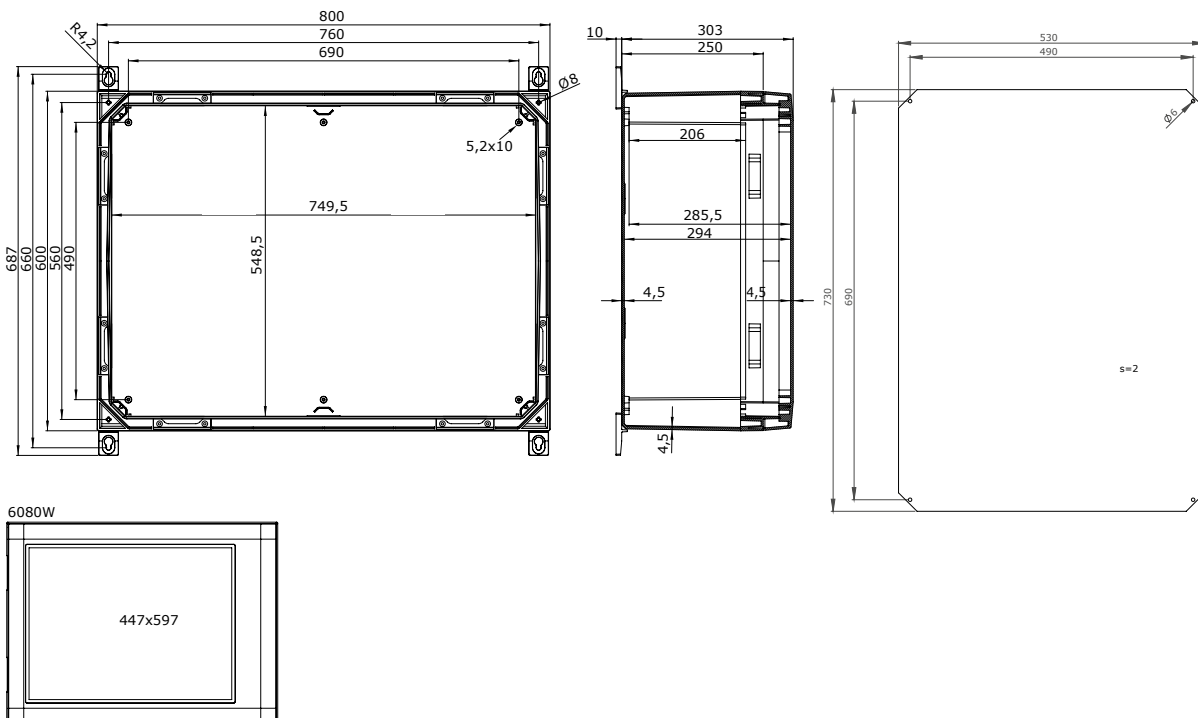

Cabinet base, door with PUR gasket, mounting plate, screws for mounting plate. 3 mm double bit lock(s) with key. 5 versions with swinghandle 2-point locking system. Door guide included.

Schaltschrankunterteil, Tür mit PUR-Dichtung, Montageplatte (Stahl, verz.), Montageschrauben. 3 mm Doppelbartvorreiber mit Schlüssel. 5 Version mit 2-Punktverschluß und Schwenkhebel. Türführung integriert.



	ORDER SYMBOL BESTELLZEICHEN	CODE ARTIKEL-NR.	EAN	DESCRIPTION BESCHREIBUNG
	MPS ARCA 7050	8120738		MOUNTING PLATE (630x430 mm), Galvanized steel MONTAGEPLATTE (630x430 mm), Stahl, verzinkt
	MPP ARCA 7050	8120758		MOUNTING PLATE PERFORATED (630x430 mm - 26x11 mm), Galvanized steel MONTAGEPLATTE, GELOCHT, TELEQUICK (630x430 mm - 26x11 mm) Stahl, verzinkt
	MPMP ARCA 7050	8120927		MOUNTING PLATE MULTIPERFORATED (630x430 mm - ø3.6 mm), Galvanized steel MONTAGEPLATTE, MULTIGELOCHT (630x430 mm - ø3.6 mm) Stahl, verzinkt
	MPX ARCA 7050	8120748		MOUNTING PLATE (630x430 mm) Resin bonded paper board MONTAGEPLATTE (630x430 mm) Hardpapier, isoliert
	DRS ARCA 705030	8120775		DIN RAIL FRAME SET 4 rows x 21 modules MONTAGERAHMEN F. REIHENEINBAUGERÄTE, (SET) 4-reihig, je 21 Module
	IDS ARCA 7050	8120718		INNER DOOR SET Galvanized steel, RAL 7035 INNENTÜR (SET) Stahl, verzinkt, lackiert RAL 7035
	PMK ARCA 50	8120843		POLE MOUNTING KIT for pole ø100-300 mm MASTBEFESTIGUNG, (SET) Mast ø100-300 mm
	RCS ARCA 7050	8120951		RAIN CANOPY SET REGENSCHUTZKANTE FÜR 7050
	DSP ARCA LM	8120964		DOOR STOPPER ARCA left, midsize, for 5070-8060 TÜRFESTSTELLER Anschlag links, midsize, für 5070-8060
	DSP ARCA RM	8120965		DOOR STOPPER ARCA right, midsize, for 5070-8060 TÜRFESTSTELLER Anschlag rechts, midsize, für 5070-8060



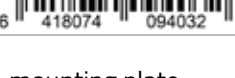



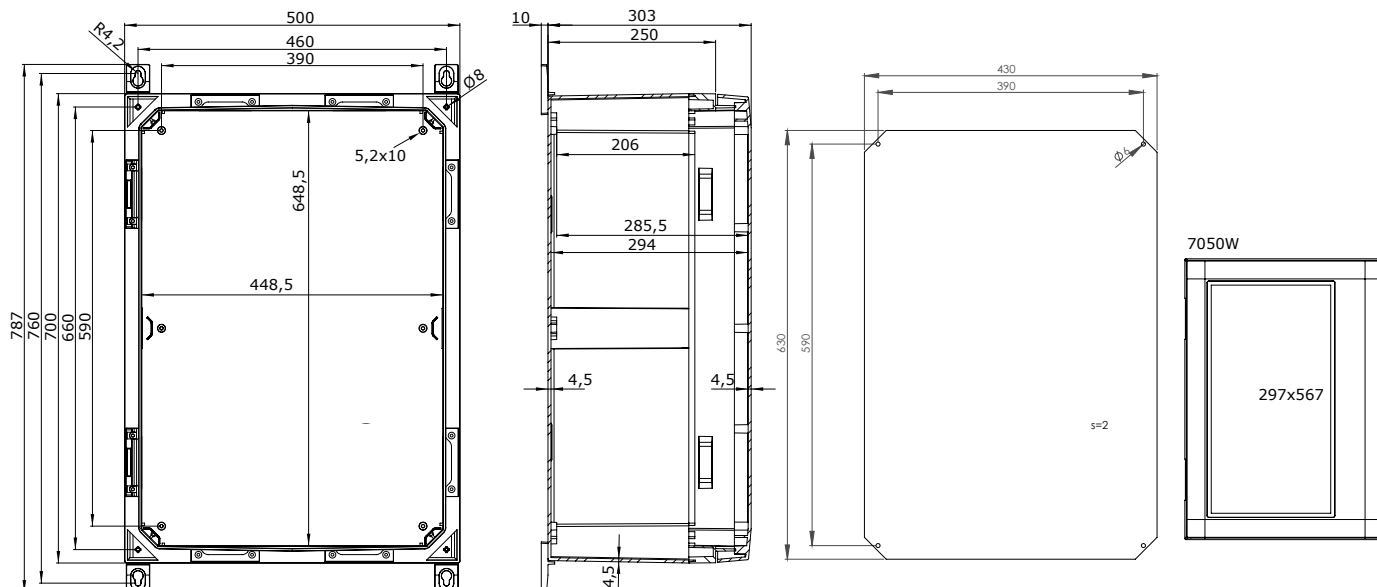

ORDER SYMBOL BESTELLZEICHEN	CODE ARTIKEL-NR.	EAN	DESCRIPTION BESCHREIBUNG
ARCA 705030	8120017	 6 418074 079282	2-POINT LOCKING 2-PUNKT SCHLIESSUNG
ARCA 705030S	8120097	 6 418074 079800	SWINGHANDLE SCHWENKHEBEL
ARCA 705030W	8120137	 6 418074 080080	COVER WITH WINDOW, 2-POINT LOCKING SICHTTÜR, 2-PUNKT SCHLIESSUNG
ARCA 705030 NO MP	8120017N	 6 418074 089380	2-POINT LOCKING, NO MOUNTINGPLATE 2-PUNKT SCHLIESSUNG, KEINE MONTAGEPLATTE
ARCA 705030S NO MP	8120097N	 6 418074 095015	SWINGHANDLE, NO MOUNTINGPLATE SCHWENKHEBEL, KEINE MONTAGEPLATTE
ARCA 705030W NO MP	8120137N	 6 418074 094032	COVER WITH WINDOW, 2-POINT LOCKING, NO MOUNTINGPLATE SICHTTÜR, 2-PUNKT SCHLIESSUNG, KEINE MONTAGEPLATTE







Cabinet base, door with PUR gasket, mounting plate, screws for mounting plate. 3 mm double bit lock(s) with key. 5 versions with swinghandle 2-point locking system. Door guide included.

Schaltschrankunterteil, Tür mit PUR-Dichtung, Montageplatte (Stahl, verz.), Montageschrauben. 3 mm Doppelbartvorreiber mit Schlüssel. 5 Version mit 2-Punktverschluss und Schwenkhebel. Türführung integriert.



	ORDER SYMBOL BESTELLZEICHEN	CODE ARTIKEL-NR.	EAN	DESCRIPTION BESCHREIBUNG
	MPS ARCA 8060	8120739		MOUNTING PLATE (730x530 mm), Galvanized steel MONTAGEPLATTE (730x530 mm), Stahl, verzinkt
	MPP ARCA 8060	8120759		MOUNTING PLATE PERFORATED (730x530 mm - 26x11 mm), Galvanized steel MONTAGEPLATTE, GELOCHT, TELEQUICK (730x530 mm - 26x11 mm) Stahl, verzinkt
	MPMP ARCA 8060	8120928		MOUNTING PLATE MULTIPERFORATED (730x530 mm - ø3.6 mm), Galvanized steel MONTAGEPLATTE, MULTIGELOCHT (730x530 mm - ø3.6 mm) Stahl, verzinkt
	MPX ARCA 8060	8120749		MOUNTING PLATE (730x530 mm) Resin bonded paper board MONTAGEPLATTE (730x530 mm) Hardpapier, isoliert
	DRS ARCA 806030	8120777		DIN RAIL FRAME SET 4 rows x 26 modules MONTAGERAHMEN F. REIHENEINBAUGERÄTE, (SET) 4-reihig, je 26 Module
	IDS ARCA 8060	8120719		INNER DOOR SET Galvanized steel, RAL 7035 INNENTÜR (SET) Stahl, verzinkt, lackiert RAL 7035
	PMK ARCA 60	8120844		POLE MOUNTING KIT for pole ø100-300 mm MASTBEFESTIGUNG, (SET) Mast ø100-300 mm
	RCS ARCA 8060	8120950		RAIN CANOPY SET REGENSCHUTZKANTE FÜR 8060
	DSP ARCA LM	8120964		DOOR STOPPER ARCA left, midsize, for 5070-8060 TÜRFEFESTSTELLER Anschlag links, midsize, für 5070-8060
	DSP ARCA RM	8120965		DOOR STOPPER ARCA right, midsize, for 5070-8060 TÜRFEFESTSTELLER Anschlag rechts, midsize, für 5070-8060









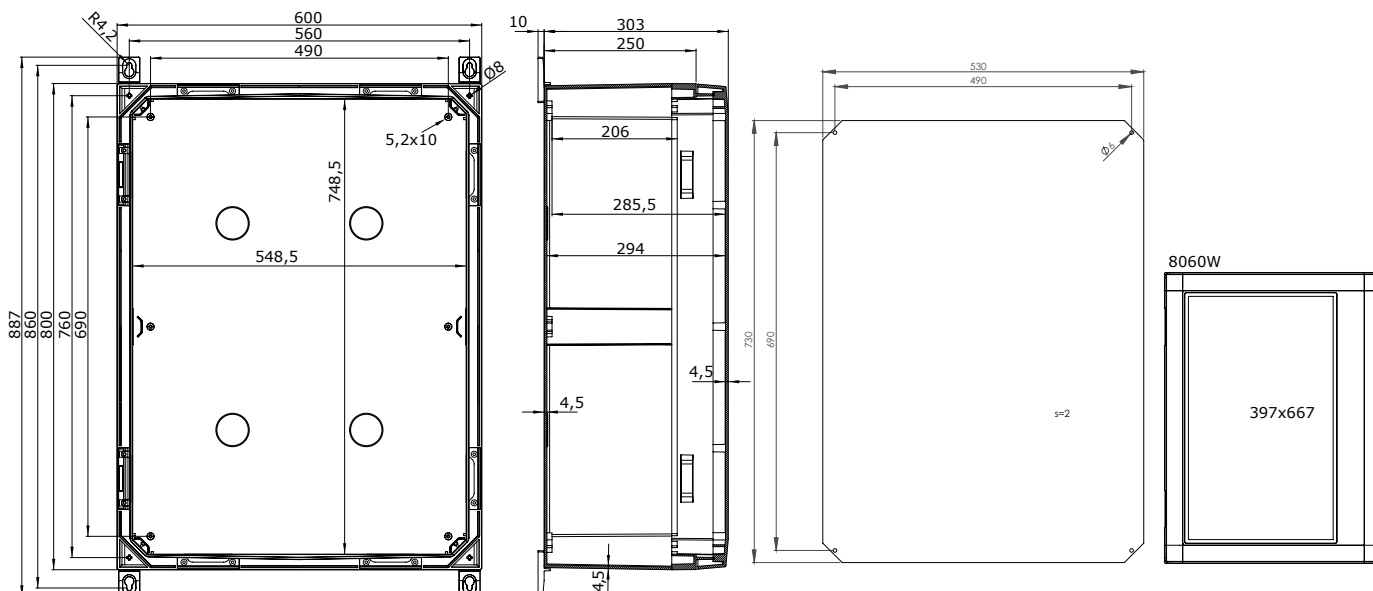

ORDER SYMBOL BESTELLZEICHEN	CODE ARTIKEL-NR.	EAN	DESCRIPTION BESCHREIBUNG
ARCA 806030	8120019	 6 418074 079305	2-POINT LOCKING 2-PUNKT SCHLIESSUNG
ARCA 806030S	8120099	 6 418074 079824	SWINGHANDLE SCHWENKHEBEL
ARCA 806030W	8120139	 6 418074 080103	COVER WITH WINDOW, 2-POINT LOCKING SICHTTÜR, 2-PUNKT SCHLIESSUNG
ARCA 806030 NO MP	8120019N	 6 418074 089397	2-POINT LOCKING, NO MOUNTINGPLATE 2-PUNKT SCHLIESSUNG, KEINE MONTAGEPLATTE
ARCA 806030S NO MP	8120099N	 6 418074 095022	SWINGHANDLE, NO MOUNTINGPLATE SCHWENKHEBEL, KEINE MONTAGEPLATTE
ARCA 806030W NO MP	8120139N	 6 418074 094049	COVER WITH WINDOW, 2-POINT LOCKING, NO MOUNTINGPLATE SICHTTÜR, 2-PUNKT SCHLIESSUNG, KEINE MONTAGEPLATTE

Cabinet base, door with PUR gasket, mounting plate, screws for mounting plate. 3 mm double bit lock(s) with key. 5 versions with swinghandle 2-point locking system. Door guide included.

Schaltschrankunterteil, Tür mit PUR-Dichtung, Montageplatte (Stahl, verz.), Montageschrauben. 3 mm Doppelbartvorreiber mit Schlüssel. 5 Version mit 2-Punktverschluss und Schwenkhebel. Türführung integriert.



ARCA IEC ACCESSORIES – ZUBEHÖR

	ORDER SYMBOL BESTELLZEICHEN	CODE ARTIKEL-NR.	EAN	DESCRIPTION BESCHREIBUNG
WALL MOUNTING LUGS SET / BEFESTIGUNGSLASCHE				
	WМК ARCA 10 SMALL	8120830		WALL MOUNTING LUGS SET FOR 2030-6040 , adds 10 mm between wall and cabinet WANDBEFESTIGUNGSLASCHEN FÜR 2030-6040 , (Set, 4 Stück), Wandabstand 10 mm
	WМК ARCA 40 SMALL	8120831		WALL MOUNTING LUGS SET FOR 2030-6040 , adds 40 mm between wall and cabinet WANDBEFESTIGUNGSLASCHEN FÜR 2030-6040 , (Set, 4 Stück), Wandabstand 40 mm
	WМК ARCA 10 MID	8120904		WALL MOUNTING LUGS SET FOR 5070-8060 , adds 10 mm between wall and cabinet WANDBEFESTIGUNGSLASCHEN FÜR 5070-8060 , (Set, 4 Stück), Wandabstand 10 mm
	WМК ARCA 40 MID	8120905		WALL MOUNTING LUGS SET FOR 5070-8060 , adds 40 mm between wall and cabinet WANDBEFESTIGUNGSLASCHEN FÜR 5070-8060 , (Set, 4 Stück), Wandabstand 40 mm
	WМКQ10S	8120832		PLASTIC WALL MOUNTING LUGS SET FOR 2030-6040 , adds 10 mm between wall and cabinet KUNSTSTOFF WANDBEFESTIGUNGSLASCHEN FÜR 2030-6040 , (Set, 4 Stück), Wandabstand 10 mm
	WМКQ50S	8120833		PLASTIC WALL MOUNTING LUGS SET FOR 2030-6040 , adds 50 mm between wall and cabinet KUNSTSTOFF WANDBEFESTIGUNGSLASCHEN FÜR 2030-6040 , (Set, 4 Stück), Wandabstand 50 mm
	WМКQ10M	8120834		PLASTIC WALL MOUNTING LUGS SET FOR 5070-8060 , adds 10 mm, between wall and cabinet KUNSTSTOFF WANDBEFESTIGUNGSLASCHEN FÜR 5070-8060 , (Set, 4 Stück), Wandabstand 10 mm
	WМКQ50M	8120835		PLASTIC WALL MOUNTING LUGS SET FOR 5070-8060 , adds 50 mm between wall and cabinet KUNSTSTOFF WANDBEFESTIGUNGSLASCHEN FÜR 5070-8060 , (Set, 4 Stück), Wandabstand 50 mm
CORNER ADJUSTMENT SETS / ECKPROFILE				
	CBS ARCA 15	8120810		CORNER ADJUSTMENT SET For sizes with depth 150 mm ECKPROFILE, (4 STÜCK) Bautiefe 150 mm
	CBS ARCA 21	8120811		CORNER ADJUSTMENT SET For sizes with depth 210 mm ECKPROFILE, (4 STÜCK) Bautiefe 210 mm
	CBS ARCA 30	8120812		CORNER ADJUSTMENT SET For sizes with depth 300 mm ECKPROFILE, (4 STÜCK) Bautiefe 300 mm

	ORDER SYMBOL BESTELLZEICHEN	CODE ARTIKEL-NR.	EAN	DESCRIPTION BESCHREIBUNG
LOCKING INSERTS / SCHLOSSEINSÄTZE				
	LIS ARCA DB3	8120860		LOCKING INSERT DOUBLE-BIT 3 MM for 2030-6040 SCHLOSSEINSATZ, DOPPELBART für 2030-6040
	MB 12235	8392235		FIBOX SPARE KEY DB3 PLASTIC FIBOX ERSATZSCHLÜSSEL DB3, KUNSTSTOF
	LIS ARCA DB3 MID	8120980		LOCKING INSERT DOUBLE-BIT 3 MM for 5070-8060 SCHLOSSEINSATZ, DOPPELBART für 5070-8060
	LIS ARCA S7	8120861		LOCKING INSERT SQUARE 7 MM for 2030-6040 SCHLOSSEINSATZ, VIERKANT 7 MM für 2030-6040
	LIS ARCA S7 MID	8120981		LOCKING INSERT SQUARE 7 MM for 5070-8060 SCHLOSSEINSATZ, VIERKANT 7 MM für 5070-8060
	LIS ARCA S8	8120862		LOCKING INSERT SQUARE 8 MM for 2030-6040 SCHLOSSEINSATZ, VIERKANT 8 MM für 2030-6040
	LIS ARCA S8 MID	8120982		LOCKING INSERT SQUARE 8 MM for 5070-8060 SCHLOSSEINSATZ, VIERKANT 8 MM für 5070-8060
	LIS ARCA T8	8120863		LOCKING INSERT TRIANGULAR 8 MM for 2030-6040 SCHLOSSEINSATZ, DREIKANT für 2030-6040
	LIS ARCA T8 MID	8120983		LOCKING INSERT TRIANGULAR 8 MM for 5070-8060 SCHLOSSEINSATZ, DREIKANT für 5070-8060
	LIS ARCA PADLOCK HANDLE MID	8120850		PADLOCKING HANDLE for 2030-6040 GRIFF FÜR VORHANGSCHLOSS für 2030-6040

ARCA IEC ACCESSORIES – ZUBEHÖR

	ORDER SYMBOL BESTELLZEICHEN	CODE ARTIKEL-NR.	EAN	DESCRIPTION BESCHREIBUNG
LOCKING INSERTS / SCHLOSSEINSÄTZE				
* 	LIS ARCA 1242E WINGKNOB	8120865	6 418074 083333	LOCKING 1242E SYSTEM for 2030-6040 KNEBELVERSCHLUSS, 1242E für 2030-6040
	LIS ARCA 1242E MID WINGKNOB	8120985	6 418074 306241	LOCKING 1242E SYSTEM for 5070-8060 KNEBELVERSCHLUSS, 1242E für 5070-8060
	LIS ARCA V2432E WINGKNOB	8120866	6 418074 083340	LOCKING V2432E SYSTEM for 2030-6040 KNEBELVERSCHLUSS, V2432E für 2030-6040
	LIS ARCA V2432E MID WINGKNOB	8120986	6 418074 306258	LOCKING V2432E SYSTEM for 5070-8060 KNEBELVERSCHLUSS, V2432E für 5070-8060
	LIS ARCA 455E WINGKNOB	8120867	6 418074 083357	LOCKING 455E SYSTEM for 2030-6040 KNEBELVERSCHLUSS, 455E für 2030-6040
	LIS ARCA 455E MID WINGKNOB	8120987	6 418074 306265	LOCKING 455E SYSTEM for 5070-8060 KNEBELVERSCHLUSS, 455E für 5070-8060
	LIS ARCA 405E WINGKNOB	8120868	6 418074 083364	LOCKING 405E SYSTEM for 2030-6040 KNEBELVERSCHLUSS, 405E für 2030-6040
*No double insulation *Keine Schutzisolation	LIS ARCA 405E MID WINGKNOB	8120988	6 418074 306272	LOCKING 405E SYSTEM for 5070-8060 KNEBELVERSCHLUSS, 405E für 5070-8060
HALF CYLINDER LOCKS FOR SWINGHANDLE / PROFILHALBZYLINDER				
	CLI ARCA DB3	8120870	6 418074 083371	HALF CYLINDER LOCKING DOUBLE-BIT 3 MM PROFILHALBZYLINDER, DOPPELBART 3 MM
	CLI ARCA S7	8120871	6 418074 083388	HALF CYLINDER LOCKING SQUARE 7 MM PROFILHALBZYLINDER, VIERKANT 7 MM
	CLI ARCA S8	8120872	6 418074 083395	HALF CYLINDER LOCKING SQUARE 8 MM PROFILHALBZYLINDER, VIERKANT 8 MM
	CLI ARCA T8	8120873	6 418074 083401	HALF CYLINDER LOCKING TRIANGULAR 8 MM PROFILHALBZYLINDER, DREIKANT 8 MM
	CLI ARCA 1242E	8120875	6 418074 083425	HALF CYLINDER LOCKING 1242E SYSTEM PROFILHALBZYLINDER, 1242E
	CLI ARCA V2432E	8120876	6 418074 083432	HALF CYLINDER LOCKING V2432E SYSTEM PROFILHALBZYLINDER, 2432E
	CLI ARCA 455E	8120877	6 418074 083449	HALF CYLINDER LOCKING 455E SYSTEM PROFILHALBZYLINDER, 455E
	CLI ARCA 405E	8120878	6 418074 083456	HALF CYLINDER LOCKING 405E SYSTEM PROFILHALBZYLINDER, 405E

PROPERTY EIGENSCHAFTEN	POLYCARBONATE (PC) POLYCARBONAT (PC)
MATERIAL MATERIAL	Glass fibre reinforced polycarbonate Polycarbonat (PC), glasfaserverstärkt (10%)
INGRESS PROTECTION (EN 60529) SCHUTZART (EN 60529)	IP 66 (IP 65 W-versions)
IMPACT RESISTANCE (EN 62262) SCHLAGFESTIGKEIT (EN 62262)	IK 10 +35 °C/ IK 09 -25 °C (IK 08 W-versions)
TEMPERATURE RANGE CELSIUS (CONTINUOUS) TEMPERATUR °C (DAUERGERBRAUCH)	-40° – +80 °C
FAHRENHEIT TEMPERATUR °F (DAUERGERBRAUCH)	-40° – +175 °F
TEMPERATURE RANGE CELSIUS (SHORT TERM) TEMPERATUR °C (KURZZEIT)	-40° – +120 °C
FAHRENHEIT TEMPERATUR °F (KURZZEIT)	-40° – +245 °F
ELECTRICAL INSULATION ELEKTRISCHE ISOLIERUNG	Totally insulated Schutzisoliert
LIGHT GREY PARTS COLOUR GEHÄUSEFARBE	RAL 7035 (Industry grey) RAL 7035 (Lichtgrau)
GLOW WIRE TEST (IEC 695-2-1) GLÜHDRAHTTEST (IEC 695-2-1) °C	960°
FLAMMABILITY RATING (MATERIAL)	UL 94-5VA
NON-TOXICITY SCHADSTOFFKLASSE	Halogen Free (DIN/VDE 0472, Part 815) Halogen frei (DIN/VDE 0472, Part 815)
UV RESISTANCE UV RESISTENZ	UL 508; 720 hours in "Weatherometer" UL 508; 720 Std. im Bewitterungstest
GASKET DICHTUNGSMATERIAL	PUR
CHEMICAL RESISTANCE CHEMISCHE BESTÄNDIGKEIT	Good Gut

Data subject to change without notice. Technische Änderungen vorbehalten.

CONFIRMITY TO STANDARDS/DIRECTIVES

ÜBEREINSTIMMEND MIT FOLGENDEN STANDARDS / VORSCHRIFTEN

- EN/IEC 62208, EN/IEC 61439-1-4
- Low Voltage Directive 2006/95/EC
(up to 1500 VCD)
Niederspannungsrichtlinie 2006/95/EC (bis 1500 VDC)
- RoHS directive 2011/65/EU
RoHS Richtlinie 2011/65/EU
- GostR – Gost Russian Certificate
of Conformity
- USA Enclosures for Electrical
Equipment
PC: UL Type 4, 4X, 12 or 13; UL File
E75645 Vol 1
Sec 10; UL 746C-5VA flame test
(UL 50/508)*
USA Gehäuse für elektrische Ausrüstung
PC: UL Type 4, 4X, 12 oder 13; UL Akte
E75645 Vol 1
Sec 10; UL 746C-5VA vertikaler
Flammentest (UL 50/508)*

PLASTIC CABLE GLAND KABELVERSCHRAUBUNG KUNSTSTOFF

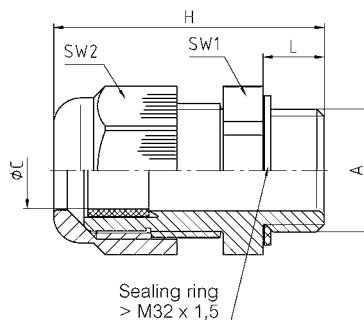

Technical details

Dome nut	Polyamide PA6 V-2
Sealing ring	Polychloroprene-Nitrile rubber CR/NBR
Gland body	Polyamide PA6 V-2
Connecting thread	Metric as per EN 60423

Properties

- Integrated anchorage
- Wide sealing and clamping range
- Easy-to-install

Temperature range -20...+100 °C

Protection grade IP 68 – 5 bar

Test standard EN 50262 / UL 514B

Technische Informationen

Hutmutter	Polyamid PA6 V-2
Dichtring	Polychloropren-Nitrilkautschuk CR/NBR
Zwischenstutzen	Polyamid PA6 V-2
Anschlussgewinde	Metrisch nach EN 60423

Eigenschaften

- Integrierte Zugentlastung
- Großer Dicht- und Klemmbereich
- Montagefreundlich

Temperaturbereich -20...+100 °C

Schutzart IP 68 – 5 bar

Prüfnorm EN 50262 / UL 514B

ORDER SYMBOL BESTELLZEICHEN	CODE ARTIKEL-NR.	EAN	A	C (mm)	L (mm)	SW1 (mm)	SW2 (mm)	H (mm)	PACK
RAL 7035: CONNECTING THREAD: STANDARD LENGTH RAL 7035: ANSCHLUSSGEWINDE: STANDARDLÄNGE									
GPA M12	7016400	6418074054845	M12 x 1,5	3 – 6	8	15	15	31	100
GPA M16	7016401	6418074054852	M16 x 1,5	5 – 10	8	20	20	35,5	100
GPA M20	7016402	6418074054869	M20 x 1,5	8 – 13	8	24	24	36	100
GPA M25	7016403	6418074054876	M25x 1,5	11 – 17	8	29	29	43	50
GPA M32	7016404	6418074054883	M32 x 1,5	15 – 21	10	36	36	50	25
GPA M40	7016405	6418074054890	M40 x 1,5	19 – 28	10	46	46	51	10
GPA M50	7016406	6418074054906	M50 x 1,5	27 – 35	12	55	55	61,5	5
GPA M63	7016407	6418074054913	M63 x 1,5	32 – 42	12	68	68	65,5	5
RAL 7035: CONNECTING THREAD: LONG RAL 7035: ANSCHLUSSGEWINDE: LANG									
GPA M12L	7016533	6418074056337	M12 x 1,5	3 – 6	15	15	15	38	100
GPA M16L	7016534	6418074056344	M16 x 1,5	5 – 10	15	20	20	42,5	100
GPA M20L	7016535	6418074056351	M20 x 1,5	8 – 13	15	24	24	43	100
GPA M25L	7016536	6418074056368	M25x 1,5	11 – 17	15	29	29	50	50
GPA M32L	7016537	6418074056375	M32 x 1,5	15 – 21	15	36	36	55	25
GPA M40L	7016538	6418074056382	M40 x 1,5	19 – 28	18	46	46	59	10
GPA M50L	7016539	6418074056399	M50 x 1,5	27 – 35	18	55	55	67,5	5
GPA M63L	7016540	6418074056405	M63 x 1,5	32 – 42	18	68	68	71,5	5

HEXAGONAL LOCKNUT, PLASTIC SECHSKANTMUTTER KUNSTSTOFF

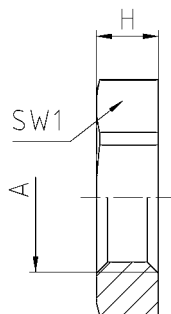

Technical details

Hexagonal locknut Polyamide PA6 GF30
Connecting thread Metric as per EN 60423

Properties

- For secure tightening of cable glands and accessories
- Temperature range -20...+100 °C

Technische Informationen

Sechskantmutter Polyamid PA6 GF30
Anschlussgewinde Metrisch nach EN 60423

Eigenschaften

- Zum sicheren Befestigen von Kabelverschraubungen und Zubehörteilen
- Temperaturbereich -20...+100 °C

ORDER SYMBOL BESTELLZEICHEN	CODE ARTIKEL-NR.	EAN	A	SW1 (mm)	H (mm)	PACK
--------------------------------	---------------------	-----	---	-------------	-----------	------

RAL 7035: CONNECTING THREAD: STANDARD LENGTH
RAL 7035: ANSCHLUSSGEWINDE: STANDARDLÄNGE

GPA M12B	7016408	6418074054920	M12 x 1,5	17	5	100
GPA M16B	7016409	6418074054937	M16 x 1,5	22	5	100
GPA M20B	7016410	6418074054944	M20 x 1,5	27	6	100
GPA M25B	7016411	6418074054951	M25 x 1,5	32	6	100
GPA M32B	7016412	6418074054968	M32 x 1,5	41	7	100
GPA M40B	7016413	6418074054975	M40 x 1,5	50	7	50
GPA M50B	7016414	6418074054982	M50 x 1,5	60	8	50
GPA M63B	7016415	6418074054999	M63 x 1,5	75	8	50

VENTING ELEMENT DRUCKAUSGLEICHELEMENT

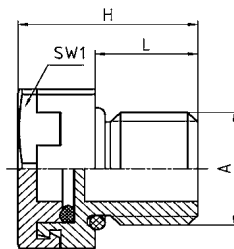

Technical details

Body	Polyamide PA6 V-0
Membrane	Polyether sulphone PES
O-ring	Nitrile rubber NBR
Connecting thread	metric as per EN 60423

Properties

- Protection for hermetically sealed electro-technical and electronic enclosures against condensation water from alternating temperature and pressure
 - Continuous ventilation and adaption of the inner pressure
 - Hydrophobic and oleophobic PES-membrane
- Typical air flow 90 – 130 ml/min/cm² at p = 0,01 bar
 Water entry pressure > 1 bar
 Temperature range -40...+100 °C
 Protection grade IP 66 / IP 67 / IP 69KT

Technische Informationen

Grundkörper	Polyamid PA6 V-0
Membran	Polyethersulfon PES
O-ring	Nitrilkautschuk NBR
Anschlussgewinde	metrisch nach EN 60423

Eigenschaften

- zum Schutz vor Kondenswasserbildung in hermetisch abgedichteten Elektro- und Elektronik-Gehäusen bei Temperatur- und Druckschwankungen
 - konstante Be- und Entlüftung sowie Anpassung des Innendrucks
 - Wasser und Öl abweisende PES-Membran
- Luftdurchsatz 90 – 130 ml/min/cm² at p = 0,01 bar
 Wassereintrittspunkt > 1 bar
 Temperaturbereich -40...+100 °C
 Schutzart IP 66 / IP 67 / IP 69K

ORDER SYMBOL BESTELLZEICHEN	CODE ARTIKEL-NR.	EAN	A	L (mm)	SW1 (mm)	H (mm)	PACK
--------------------------------	---------------------	-----	---	-----------	-------------	-----------	------

RAL 7035: CONNECTING THREAD: SHORT | RAL 7035: ANSCHLUSSGEWINDE: KURZ

GVPPA M12	7016702	6418074091314	M12 x 1,5	6	17	13,8	100
-----------	---------	---------------	-----------	---	----	------	-----

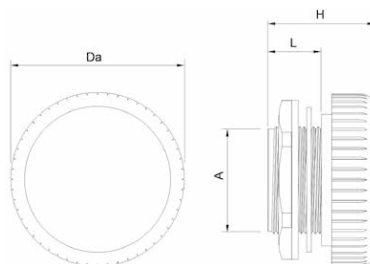

Technical details

Body	PA6
Sealing	Nitrile rubber NBR
Membrane	PA6.6

Properties

Temperature range -35 to +70 °C
 Protection grade IP 66 / IP X9K
 Air permeability 1200 l/h at a pressure difference of min. 70 mbar

Technische Informationen

Grundkörper	PA6
Dichtring	Nitrilkautschuk NBR
Membran	PA6.6

Eigenschaften

- Temperaturbereich -35...+70 °C
 Schutzart IP 66 / IP X9K
 Luftdurchlässigkeit 1.200 l/h bei einem Druckunterschied von min. 70 mbar

ORDER SYMBOL BESTELLZEICHEN	CODE ARTIKEL-NR.	EAN	A	L (mm)	DA (mm)	H (mm)	PACK
--------------------------------	---------------------	-----	---	-----------	------------	-----------	------

LIGHT GREY | LICHTGRAU

GVPPA M40	7016704	6418074012197	M40 x 1,5	18	60	37	2
-----------	---------	---------------	-----------	----	----	----	---



FIBOX WORKS WITH INDUSTRIES FROM A TO Z FIBOX ARBEITET MIT BRANCHEN VON A BIS Z

Fibox is a trusted partner in multiple industries. The flexibility and innovation gives us the opportunity to be present everywhere. We want to help our customers to succeed and we don't mind the industry, we are ready to help!

Fibox ist ein zuverlässiger Partner in zahlreichen Branchen. Die Flexibilität und Innovation gibt uns die Möglichkeit, überall präsent zu sein. Wir wollen unseren Kunden zum Erfolg verhelfen und es ist uns egal, in welcher Branche sie tätig sind, wir sind bereit zu helfen!

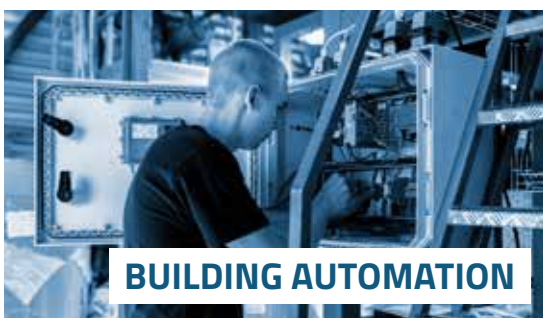
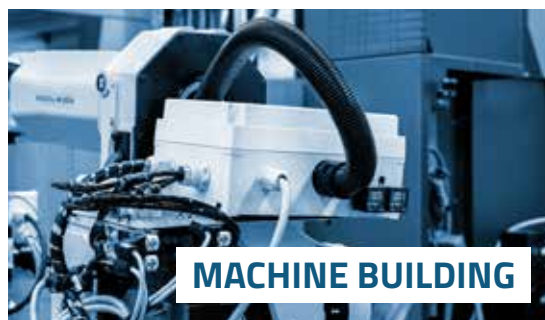
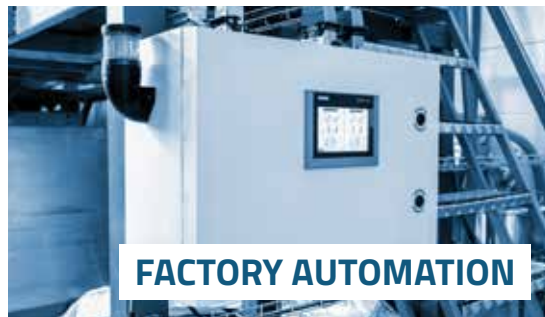

1 DISCLAIMER

The information included in this Product Catalogue ("Catalogue") is intended to be generic and the related illustrations are intended for illustration purposes. Any and all information is being provided for information purposes only and without responsibility, and Fibox Oy Ab or its affiliates makes no representations or warranties, either expressed or implied, as to the accuracy or completeness of the information, usability of a product or fitness of a product for a particular purpose.

Any and all information included in this Catalogue is subject to change without notice. While Fibox Oy Ab and its affiliates has endeavored to ensure the accuracy of the information contained in the Catalogue, it does not accept liability or responsibility for any inaccuracies.

2 SELLER'S TERMS AND CONDITIONS

The following terms and conditions cover all sales of products and rendering of services by Fibox Oy Ab and by any of its affiliates ("Seller") to Customer. These terms and conditions will supersede all previous communications, agreements or contracts, written or verbal, and no understanding, agreement, term, condition or trade custom at variance herewith will be binding on Seller. No waiver, amendment or modification of the terms and conditions hereof will be effective unless in writing and signed by an officer of Seller.

2.1 INTELLECTUAL PROPERTY

All process information, drawings, specifications, instruction manuals, catalogs and other documents furnished by Seller to Customer for the products sold hereunder shall remain the property of Seller, or its affiliates, as the case may be, and are furnished subject to the condition that Customer use the same only for operation, maintenance and repair of the products and that Customer shall not at any time copy, duplicate, disclose or publish such information. The purchase or use of Seller's products by Customer will not be construed to grant Customer any right, license, sublicense, title or interest in or to any of Seller's or its affiliates' patents, trade names, trademarks, trade secrets, copyrights and other proprietary rights and information or other intellectual, proprietary or industrial property pertaining to the Seller or its products or affiliates, all of which are acknowledged by Customer to be the sole and exclusive property of the Seller or its affiliates, as the case may be.

2.2 FIBOX LIMITED WARRANTY

Seller warrants to Customer that all products and services provided hereunder will be in accordance with specifications and substantially free from defects in material and workmanship under normal use and service for a period of one year from date of shipment. This warranty will not, however, apply to any product to the extent the same is, after delivery:

(a) repaired or altered outside of Seller's or manufacturer's factory; or
(b) subject to misuse, neglect, accident or improper storage, installation, assembly, repair or handling; (c) put to other than normal use or service; or
(d) used, maintained, installed, assembled, stored, handled or repaired under conditions which exceed the designed capabilities or in a manner which is not in compliance with Seller's recommendations or with applicable laws, regulations or codes. Seller makes no representation or warranty as to the suitability or compatibility of any product or service with Customer's own equipment, materials, components, products or purpose; and Seller will in no event have any responsibility for the design, performance, use, defect or malfunction of Customer's own equipment, materials, components or products. Seller's sole obligation, and Customer's sole remedy, under the foregoing warranty will be the repair or, at Seller's sole option the replacement, of any product which may be determined by Seller to be defective, provided that Customer shall notify Seller in writing of such defects within the one year warranty period set forth above; and, provided further that Customer will ship such products to Seller's office for repair or replacement, if necessary.

THIS PARAGRAPH SETS FOR THE EXCLUSIVE REMEDIES FOR CLAIMS BASED ON DEFECT IN OR FAILURE OF PRODUCTS OR SERVICES, WHETHER THE CLAIM IS IN CONTRACT, INDEMNITY, WARRANTY, TORT (INCLUDING SELLER'S NEGLIGENCE), STRICT LIABILITY OR OTHERWISE AND HOWEVER INSTITUTED. THE FOREGOING WARRANTIES ARE THE SOLE AND EXCLUSIVE WARRANTIES BY SELLER TO CUSTOMER, AND ARE MADE IN LIEU OF ALL OTHER WARRANTIES. THERE ARE NO OTHER WARRANTIES, EXPRESS OR IMPLIED, BY OPERATION OF LAW OR OTHERWISE, FOR ANY PRODUCT OR SERVICE SOLD OR FURNISHED HEREUNDER, AND SELLER DISCLAIMS ALL IMPLIED WARRANTIES OF MERCHANTABILITY

AND FITNESS FOR A PARTICULAR PURPOSE. ANY CATALOGUE, SAMPLE OR MODEL IS FOR ILLUSTRATIVE PURPOSES ONLY AND SHALL NOT BE DEEMED TO CREATE AN EXPRESS WARRANTY, AND NO AFFIRMATION OR PROMISE OR DESCRIPTION, OR CATALOGUE, SAMPLE OR MODEL SHALL BE DEEMED PART OF THE BASIS OF THE BARGAIN.

2.3 LIMITATION OF LIABILITY

In no event, whether as a result of breach of contract, indemnity, warranty, tort (including Seller's negligence), strict liability or otherwise, shall Seller's liability to Customer for any loss or damage arising out of, or resulting from the products or services furnished hereunder, exceed the price of the specific product or service which gives rise to the claim, and any such liability shall terminate upon the expiration of the warranty specified in Section 2.2 entitled "Warranties." Any such claim of liability must be timely commenced in a court of competent jurisdiction in accordance with the applicable statute of limitations, but in no event later than one year from the termination of the said warranty.

IN NO EVENT SHALL SELLER, ITS AFFILIATES, OFFICERS, AGENTS OR EMPLOYEES BE LIABLE FOR ANY INCIDENTAL, INDIRECT, SPECIAL OR CONSEQUENTIAL DAMAGES IN CONNECTION WITH OR ARISING FROM THE PRODUCTS OR SERVICES PROVIDED HEREUNDER, INCLUDING (WITHOUT LIMITATION) LOSS OF PROFITS OR REVENUES, INTERRUPTION OF BUSINESS, LOSS OF USE OF THE PRODUCTS OR ANY ASSOCIATED EQUIPMENT, MATERIALS, COMPONENTS OR PRODUCTS, DAMAGE TO ASSOCIATED EQUIPMENT, MATERIALS, COMPONENTS OR PRODUCTS, COST OF SUBSTITUTE PARTS, OR CLAIMS OF CUSTOMER'S CUSTOMERS FOR SUCH DAMAGES. CUSTOMER'S SOLE REMEDY FOR ANY LIABILITY OF SELLER OF ANY KIND IS LIMITED TO THE REPAIR OR REPLACEMENT OF DEFECTIVE PRODUCTS OR SERVICES AS PROVIDED IN THE IMMEDIATELY PRECEDING PARAGRAPH. CUSTOMER'S SOLE RECOURSE FOR DAMAGES IN CONNECTION WITH OR ARISING FROM THE PRODUCTS OR SERVICES PROVIDED HEREUNDER, WHETHER AS A RESULT OF BREACH OF CONTRACT, INDEMNITY, WARRANTY, TORT (INCLUDING SELLER'S NEGLIGENCE), STRICT LIABILITY OR OTHERWISE, SHALL BE AGAINST SELLER, AND CUSTOMER AGREES THAT NEITHER THE MANUFACTURER NOR SELLER'S AFFILIATES, OFFICERS, EMPLOYEES, STOCKHOLDERS OR AGENTS SHALL HAVE ANY LIABILITY THEREFOR.

2.4 FIBOX GENERAL TERMS

The Seller shall deliver the products and render the services to Customer in accordance with Fibox General Terms. However, in case of any discrepancy between Fibox General Terms and the Seller's Terms and Conditions as provided for in this Catalogue, the Seller's Terms and Conditions shall prevail.

Die Fibox AGB's in deutscher Ausführung finden Sie unter http://www.fibox.de/789/AGB_GER1.html

FIBOX CUSTOMER SERVICE

VERTRIEB WELTWEIT

Fibox Oy Ab

Keilaranta 19, 02150 Espoo, FINLAND
Tel: +358 207 785 700, Fax: +358 207 785 702
E-mail: info@fibox.fi

Fibox AB

Ekbacksvägen 28, 16849 Bromma, SWEDEN
Tel: +46 8 792 2670
E-mail: info@fibox.se

Fibox A/S

Taastrup Hovedgade 101, 1. sal, 2630 Taastrup, DENMARK
Tel: +45 4371 8055
E-mail: fibox@fibox.dk

Fibox Limited

Suite 25, Durham Tees Valley Business Centre,
Primrose Hill Industrial Estate, Orde Wingate Way,
Stockton on Tees, TS19 0GD, ENGLAND
Tel: +44 1642 604 400, Fax: +44 1642 604 600
E-mail: salesuk@fibox.com

Fibox France Sarl

Neptune II
35 bis, av. Saint Germain des Noyers
77400 Saint Thibault des Vignes, FRANCE
Tel: +33 16021 2217, Fax: +33 16021 1718
E-mail: service.client@fibox.fr

Fibox GmbH

Rehwinkel 30, 32457 Porta Westfalica, GERMANY
Tel: +49 5731 86946 0, Fax: +49 5731 86946 50
E-mail: info@fibox.de

Fibox LLC

Office B 21,
54 B Shpalernaya st.
St. Petersburg
191015 RUSSIA
Tel: +7 911 0202102

Fibox India Private Limited

Gat No- 147, A II & III, Chakan Talegaon Road, Near Rinder Automation,
A/p- Mahalunge, Tal-Khed, Dist-Pune, Maharashtra, INDIA- 410501
Tel: +91 02135 666777, Fax: +91 02135 666789
E-mail: viren.shah@fibox.com

Fibox Japan Office

Zip# 542-0081 303, Daiwa building,
2-4-19, Minamisenba, Chuo-Ku, Osaka, JAPAN
Tel: +81 6 4963 3752, Fax: +81 6 4963 3762
Mobile: +81 90 2705 6742
E-mail: m.takeda@fibox.co.jp

Fibox Benelux

Postbus 350, 7570 AJ Oldenzaal, THE NETHERLANDS
Tel: +31 541 539039, Fax: +31 541 533399
E-mail: info@fibox.nl

Fibox (Schweiz) GmbH

Wissenschwändi 6-
6314 Unterägeri, SWITZERLAND
Tel: +41 55 617 20 80, Fax: +41 55 617 20 89
E-mail: info@fibox.ch

Fibox Sp. z o.o.

ul. Dzieciola 19, 04-988 Warszawa, POLAND
Tel: +48 22 256 57 99, Fax: +48 22 256 57 90
E-mail: info@fibox.pl

Fibox Inc.

810 Cromwell Park Drive Suite R, Glen Burnie, MD 21061 USA
Tel: +1 410 760 9696, Fax: +1 410 760 8686
E-mail: sales@fiboxusa.com

Fibox Shanghai Ltd

1F, 11B, No.999 Jiangyue Rd, Pujiang Town, Minhang District,
Shanghai, PRC
Tel: +86 21 6495 9922, Fax: +86 21 6495 9667
E-mail: info@fibox.cn

Fibox (Guangzhou) Engineering Plastic Co., Ltd

No.36 Dong-Peng-Da-Dao, Fibox Road
Guangzhou Economic & Technological Development District, 510530
Guangzhou, Guangdong, CHINA
Tel: +86 20 3206 7660, Fax: +86 20 3206 7661

Fibox Ltd (Korea)

11-25, Songdo-dong
Yeonsu-gu, Incheon,
KOREA (South)
Tel: +82 32 814 6742, Fax: +82 32 814 6077
E-mail: sales@fibox.co.kr

Fibox Ltd (Korea)

Pusan Office, 562-54, Gwai-Bup, Sasang-gu, Pusan,
KOREA (South)
Tel: +82 51 317 8500, Fax: +82 51 314 5533

FIBOX PRODUCTION

FIBOX-PRODUKTIONS-STANDORTE

FiboxPAM Oy Ab

Rajasilta 6, 33880 Lempäälä, FINLAND
Tel: +358 207 785 700, Fax: +358 207 785 801
E-mail: info@fibox.fi

Fibox Tested Systems Oy

Hovinpelto 2, 74700 Kiuruvesi, FINLAND
Tel: +358 207 785 700, Fax: +358 207 785 851
E-mail: tested.myynti@fibox.com

Fibox Sp. z o.o.

ul. Dzieciola 19, 04-988 Warszawa, POLAND
Tel: +48 22 256 57 99, Fax: +48 22 872 96 98
E-mail: info@fibox.pl

Fibox India Private Limited

Gat No- 147, A II & III, Chakan Talegaon Road
Near Rinder Automation, A/p- Mahalunge,
Tal-Khed, Dist- Pune, Maharashtra, INDIA- 410501
Tel: +91 02135 666777, Fax: +91 02135 666789
E-mail: viren.shah@fibox.com

Fibox Inc.

810 Cromwell Park Drive Suite R, Glen Burnie, MD 21061 USA
Tel: +1 410 760 9696, Fax: +1 410 760 8686
E-mail: sales@fiboxusa.com

Fibox Shanghai Ltd

1F, 11B, No.999 Jiangyue Rd, Pujiang Town, Minhang District,
Shanghai, PRC
Tel: +86 21 6495 9922, Fax: +86 21 6495 9667
E-mail: info@fibox.cn

Fibox Ltd (Korea)

11-25, Songdo-dong
Yeonsu-gu, Incheon,
KOREA (South)
Tel: +82 32 814 6742, Fax: +82 32 814 6077
E-mail: sales@fibox.co.kr

Fibox (Guangzhou) Engineering Plastic Co. Ltd

No.36 Dong-Peng-Da-Dao, Fibox Road
Guangzhou Economic & Technological Development District,
510530 Guangzhou, Guangdong, CHINA
Tel: +86 20 3206 7660, Fax: +86 20 3206 7661

Fibox GmbH

Rehwinkel 30, 32457 Porta Westfalica, GERMANY
Tel: +49 5731 86946 0, Fax: +49 5731 86946 50
E-mail: info@fibox.de

FIBOX

Enclosing innovations

Fibox Oy Ab

Keilaranta 19, 02150 Espoo, FINLAND

Tel: +358 207 785 700

Fax: +358 207 785 702

E-mail: sales@fibox.com

fibox.com

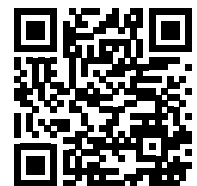

Code: 9636140 | © Fibox Oy Ab

www.fibox.com

X-ON Electronics

Largest Supplier of Electrical and Electronic Components

Click to view similar products for [Enclosures, Boxes & Cases](#) category:

Click to view products by [Fibox](#) manufacturer:

Other Similar products are found below :

[585-R-WH-PK](#) [M-10-PLATED](#) [60566-01-000](#) [HPL-9VB BATT DOOR](#) [M18-PLTD](#) [M-21-PLATED](#) [63310-01-000](#) [6711GSKT](#)
[71884-29-028](#) [LH45-100 Black](#) [72868-510-000](#) [CNS-0000 Black](#) [72883-510-000](#) [CNS-0101 Black](#) [72906-510-000](#) [CNS-0407 Black](#) [73092-](#)
[510-000](#) [CNM-0101 Black](#) [73105-510-000](#) [CNL-0101 Black](#) [73395-510-039](#) [CNS-0006 Bone](#) [74016-510-000](#) [CNL-0006 Black](#) [74257-510-000](#)
[CNL-0004](#) [MDC-1183-PLAIN-ALUM](#) [MDC-1183-PTD](#) [MDC-13104-PTD](#) [MDC-321-PTD](#) [MDC-973-PTD](#) [76](#) [77153-01-028](#) [FLX6030](#)
[83535-01-508](#) [90026-501-000](#) [PS36-200](#) [116-508](#) [120-407](#) [120-910](#) [127-908](#) [130-008](#) [1301170079](#) [1322GSKTEP](#) [1325GSKT3](#) [138-PLAIN](#)
[1434-1210](#) [EAS-500 \(BLACK ANO\)](#) [1804RP-RB-PK](#) [190-005](#) [2202307](#) [KAB3321 BLACK](#) [KAB3421](#) [2697466](#) [S52213](#) [2901123](#) [2901699](#)
[A0645271](#) [A20P20](#) [2106-IR](#) [PERF-850-PLN](#)