

FIBOX

Enclosing innovations



ENCLOSURE OVERVIEW

Product Guide 2020

Enclosures

Cabinets

Accessories

Services

CABINETS

ARCA	200 x 300 x 150 mm – 800 x 600 x 300 mm	08
CAB	200 x 300 x 180 mm – 600 x 400 x 220 mm	12
STRC	420 x 265 x 250 mm – 1125 x 1445 x 320 mm	33

ENCLOSURES

MNX	100 x 100 x 35 mm – 360 x 255 x 152 mm	14
EK	190 x 190 x 130 mm – 760 x 560 x 250 mm	16
SOLID	190 x 190 x 130 mm – 760 x 560 x 250 mm	18
EURONORD	50 x 52 x 40 mm – 360 x 400 x 151 mm	20
ALN	60 x 66 x 46 mm – 310 x 600 x 180 mm	22
TEMPO	95 x 65 x 60 mm – 344 x 289 x 157 mm	24
PICCOLO	110 x 80 x 65 mm – 230 x 140 x 125 mm	26
QUICK	300 x 200 x 170 mm – 600 x 400 x 270 mm	28
CARDMASTER	166 x 160 x 80 mm – 390 x 316 x 167 mm	30
JB	90 x 90 x 49 mm, 110 x 110 x 49 mm	32

GENERAL ACCESSORIES

CABLE MANAGEMENT	34
VENTILLATION DEVICES	36
INSPECTION WINDOW	36

FIBOX

Enclosing innovations

Innovation is defined as something newly introduced. Perhaps it is a new method, an improved solution, a new design, or an entirely new device. Whatever your innovation, it represents a change for the better, and as always, it is the result of both your inspiration and your hard work.

At Fibox, we appreciate your effort and match it with our own. Fibox is the leading innovator in developing enclosure solutions to protect your electrical and electronic designs from hostile environments. Simply put, we enclose your innovations.

OVER 50 YEARS EXPERIENCE

In 1966, Fibox introduced the first modular enclosure injection moulded from polycarbonate plastic. These enclosures began a new era in electrical panel building. From the beginning, a commitment to innovation resulted in continuous product improvement, resulting in more than 20 patents. Our on-going product development has fuelled the dramatic and rapid growth of Fibox.

Whatever your application, the Fibox enclosure product family features the widest range of high quality enclosures for the packaging and protection of electrical and electronic components and systems. Fibox offers over 1000 enclosure variations. Enclosures can be delivered in standard off-the-shelf configurations, or customized to your exact specification. For higher volume OEM's, Fibox offers custom moulds and contract manufacturing.

TECHNICAL INNOVATION

Fibox is the industry leader in developing both new products and new technologies for injection moulding thermoplastic enclosures. At Fibox, we consider moulding technology a key element contributing to product improvement. For example, the Fibox MNX enclosure series features 2 component moulding technology to insure a precision-formed TPE gasket that guarantees superior ingress protection ratings. Fibox was first to introduce this innovation, and continues as the only producer applying this technology to electrical enclosures.

A further example is our emphasis on multiple slide technology for mould construction. While more complex and costly, this type of mould provides our OEM customers with cost-effective alternatives for modifying standard enclosures to meet their specific needs.

But beyond technology, our success depends upon understanding the requirements of our customers and the value they place upon our contributions to their success. We know our customers derive the inspiration for their innovations by listening to and understanding the needs of their customers. Thus, our products are designed in close cooperation with our customers and we value the input of our global customer base to produce new enclosure solutions, useful functional accessories and on-going product innovations.



CUSTOMISING

FIBOX CUSTOMISING SERVICES

MACHINING SERVICE

Fibox employs state-of-the-art machines to manufacture your custom-made enclosures with drills, knockouts or openings – even for small piece numbers.

ASSEMBLY SERVICE

Have you ordered hinges, inspection windows or other Fibox accessories? Do you know our assembly service can deliver your enclosure and accessories pre-assembled and ready for use. This cuts down your labour costs and time to delivery.

TOOL MODIFICATIONS FOR OEM ENCLOSURES

Instead of having to manufacture a whole new tool Fibox can modify our own standard tools according to your OEM enclosure specification. This results in a shorter product development time and enables you to take your product to market earlier.

Modifications of our standard tools give you a possibility to differentiate your products from your competitors.

COLOURED ENCLOSURES

Paint your enclosures in your corporate colour. Fibox offers customers a choice of custom or RAL colour for plastic enclosures, even for relatively small quantities.

LACQUERED ENCLOSURES

Fibox provides a lacquer coating for your enclosures on request. This process is especially recommended for production quantities of under 500 pieces. We offer a comprehensive range of lacquer options.

EMC PROTECTION FOR ENCLOSURES

Fibox can provide your plastic enclosure with EMC protection if desired. For example we can apply a conductive copper coating to the inside faces, or utilising a special conductive gasket....or both.

PRINTED ENCLOSURES

Fibox can supply your enclosures with silk screen printing to your specification. Smooth, even surfaces are required.



WEB SERVICES

ALWAYS UP TO DATE

Visit www.fibox.com to keep up to date with the latest developments from Fibox. Our interactive website can also assist you in selecting the right enclosure for your requirement first time by providing you with a 2D/3D CAD download facility, dimensional drawings, detailed material and performance specifications and regulatory approvals. The latest product catalogues and leaflets are also available to download from the Fibox website.

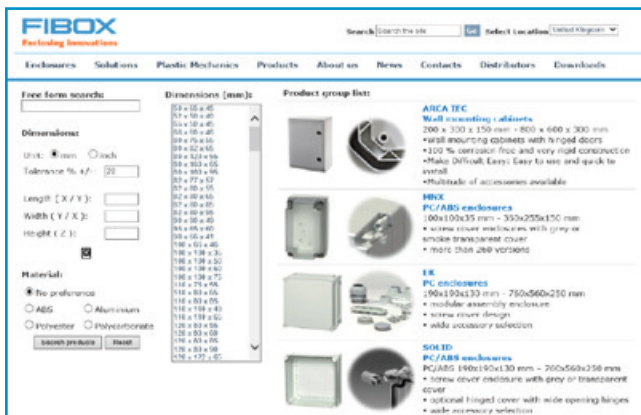

Wherever you are in the world there is access to the Fibox website in local languages. These are Chinese, Danish, Dutch, English, Finnish, French, German, Japanese, Korean, Polish, Russian and Swedish. Help us to improve our web offering by giving us feedback. We are always very willing to listen to your comments and adopt change wherever possible.

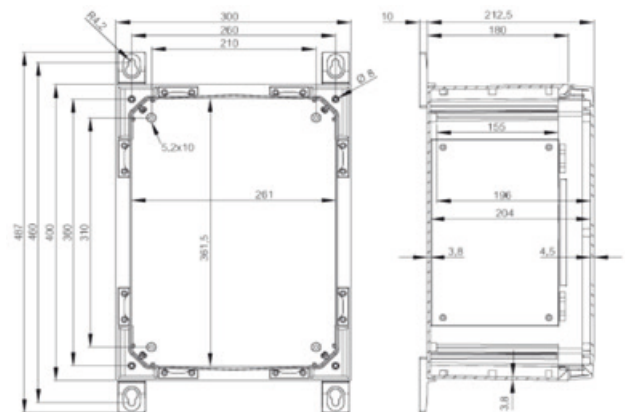

FX CAD

ONLINE ENCLOSURE CONFIGURATION AND QUOTE REQUEST

In 2018 Fibox has announced the launch of a brand-new online configurator for enclosures and control cabinets. The tool enables individual planning of housings for control and display devices and power distribution components with custom breakouts. Users are also able to immediately request quotes. All product series in the entire extensive Fibox program are integrated in the configuration software.

Users can either directly select their preferred series or specify the enclosure size and material. The enclosure is visualized as a 3-D model. Breakout openings can be positioned by drag and drop or by entering coordinates. The configurator suggests matching accessories, for example cable glands for threaded holes. Additional installation components such as mounting plates and rails sized for the specified enclosure are also presented and can comfortably be dragged into the parts list. Short mouseover texts explain the available options; further information is readily available via direct links to the product catalog.

After registration, users can save and further process their configurations. A download link for technical drawings and CAD data (file formats: PDF and DXF) will be sent via email.

The enclosure configurator is available at the company website www.fibox.com in English and German, with additional language versions to follow.

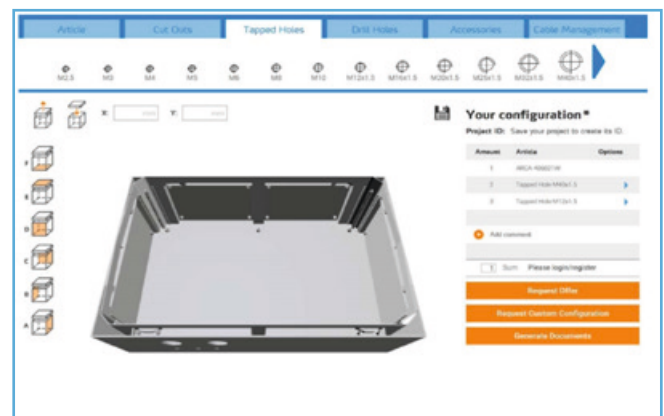

OUR MARKETS

SOLUTIONS FOR DEMANDING ENVIRONMENTS

At Fibox, we appreciate your efforts and achievements and adapt to your performance requirements. Fibox can give you the necessary support, allowing you to concentrate on your core business and thus save time and money.

Fibox is the right partner for a long-term and trustworthy partnership. We are committed to ensuring our full support throughout the life span of our products. Fibox can significantly reduce your workload not only by assisting you in product development regarding construction, rapid prototyping processes, tooling and production but also in the area of marking products with your trademark. This leaves you free to fully concentrate on your core business as well as on effective project organisation, which puts your products on the market faster.

- Shortening of lead and delivery times – global Fibox service
- Increasing sales – Fibox supplements your product range
- Reduction of investment risk – Fibox shares investment costs with you
- Better quality – Fibox complies with the quality standard ISO 9001:2000
- Top-class enclosures – Fibox offers protection of your innovations



TELECOM & DATA

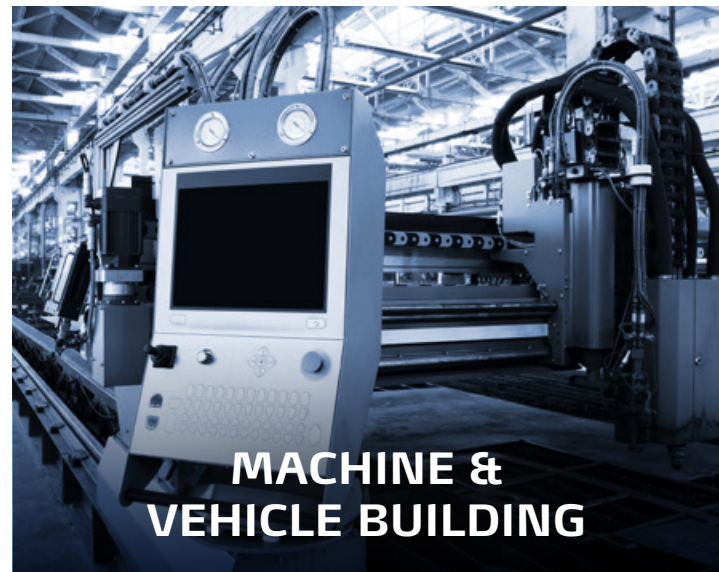

MACHINE & VEHICLE BUILDING



ENVIRONMENT



RENEWABLE ENERGY

PRODUCT RANGE

CHOOSE THE RIGHT PRODUCT RANGE FOR YOUR APPLICATION

Product group	Control unit/cabinet	Power distribution unit/cabinet	Power distribution board	Terminal enclosure	Junction box	Instrumentation	Electronic devices
ARCA	●	●	—	—	—	—	—
CAB	●	—	—	—	—	—	—
MNX	—	—	—	●	—	●	●
EK	●	●	●	●	—	—	—
SOLID	●	●	—	●	—	—	—
EURONORD	—	—	—	●	—	●	●
ALN	●	—	—	●	—	●	●
TEMPO	—	—	—	●	●	—	—
PICCOLO	●	—	—	●	—	●	—
QUICK	●	●	—	—	—	—	—
CARDMASTER	—	—	—	—	—	●	●
JB	—	—	—	—	●	—	—
STRC	●	●	—	—	—	—	—

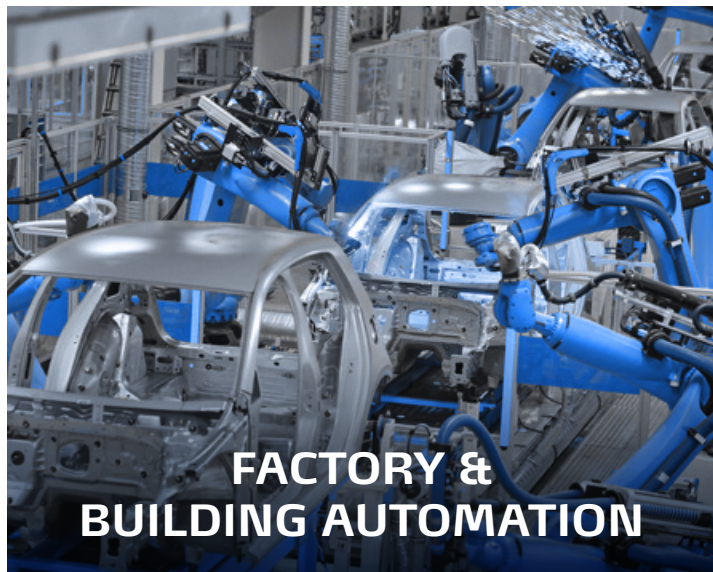

FACTORY & BUILDING AUTOMATION



TRANSPORT



UTILITIES



HEAVY INDUSTRY

ARCA

HIGH PERFORMANCE CABINET

Superior performance and security in most demanding environments. Easy to use. Quick to install. All this is driven by innovation and market driven product development. ARCA is a non corrosive and cost effective alternative to sheet steel cabinets being installed in harsh and demanding environments. In a nutshell, ARCA has all the features of steel but benefits of high grade thermoplastic.

PC: IP 66; IK 10
IP 65; IK 08 (W-versions)



DIMENSIONS:

200 x 300 x 150 mm – 800 x 600 x 300 mm



Non corrosive



Patent hinge design



Robust corner design

SIZES AND PRODUCT VERSIONS

Dimensions	Standard locking grey door		Swing-handle locking grey door		Standard locking door with window	
	Code	Symbol	Code	Symbol	Code	Symbol
300 x 200 x 150	8120002	ARCA 302015			8120122	ARCA 302015W
400 x 300 x 150	8120006	ARCA 403015	8120086	ARCA 403015S	8120126	ARCA 403015W
400 x 300 x 210	8120007	ARCA 403021	8120087	ARCA 403021S	8120127	ARCA 403021W
500 x 400 x 210	8120011	ARCA 504021	8120091	ARCA 504021S	8120131	ARCA 504021W
600 x 400 x 210	8120012	ARCA 604021	8120092	ARCA 604021S	8120132	ARCA 604021W
700 x 500 x 300	8120017	ARCA 705030	8120097	ARCA 705030S	8120137	ARCA 705030W
800 x 600 x 300	8120019	ARCA 806030	8120099	ARCA 806030S	8120139	ARCA 806030W
200 x 300 x 150	8120020	ARCA 203015			8120140	ARCA 203015W
300 x 400 x 150	8120022	ARCA 304015			8120142	ARCA 304015W
300 x 400 x 210	8120023	ARCA 304021			8120143	ARCA 304021W
400 x 500 x 210	8120025	ARCA 405021	8120105	ARCA 405021S	8120145	ARCA 405021W
400 x 600 x 210	8120026	ARCA 406021	8120106	ARCA 406021S	8120146	ARCA 406021W
500 x 700 x 300	8120031	ARCA 507030	8120111	ARCA 507030S	8120151	ARCA 507030W
600 x 800 x 300	8120029	ARCA 608030	8120109	ARCA 608030S	8120149	ARCA 608030W

Product group	Control unit/cabinet	Power distribution unit/cabinet	Power distribution board	Terminal enclosure	Junction box	Instrumentation	Electronic devices
ARCA	●	●	–	–	–	–	–



High Performance cabinets for demanding environments.

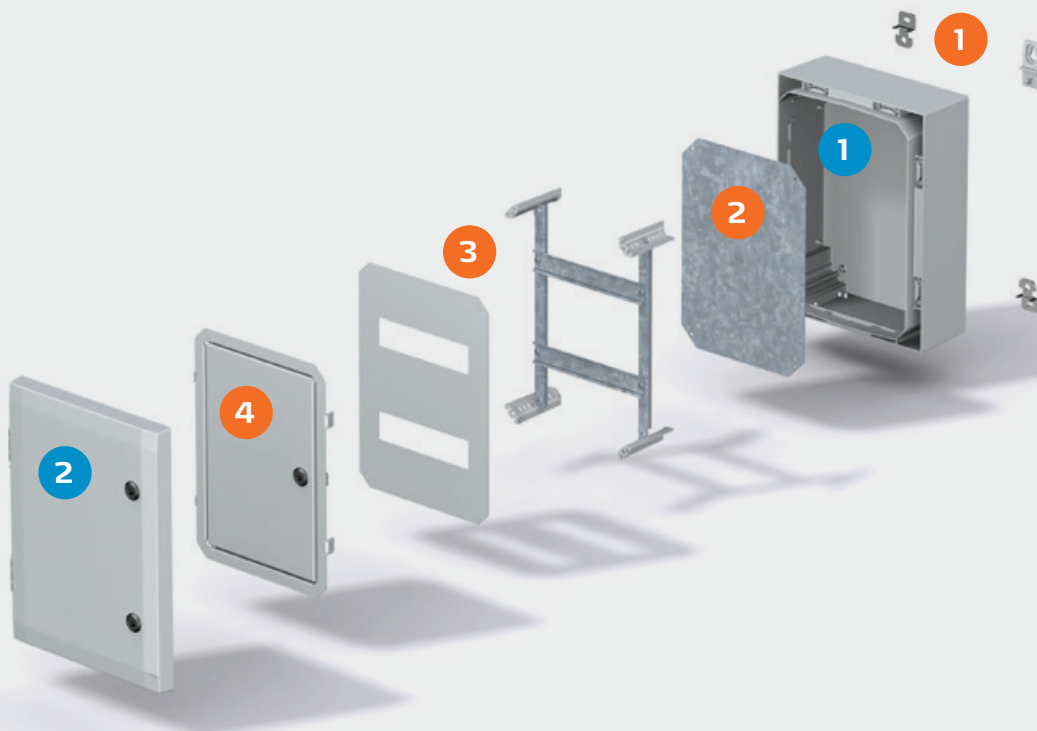

ENCLOSURE:

- 1 Enclosure base
- 2 Door, grey incl. PUR gasket and locks

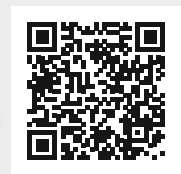

ACCESSORIES:

- 1 Fastening lugs (4 pcs.) incl. screws, stainless steel or plastic
- 2 Mounting plate, electro-galvanized steel
- 3 DIN-rail set with front plate
- 4 Inner door

Including:

Cabinet base, door with PUR gasket, mounting plate, screws for mounting plate, 3 mm double bit lock(s) with key, door guide. S versions with swinghandle 2-point locking system. W versions with glazed door.

ARCA

HIGH PERFORMANCE CABINET



Double corner construction for increased rigidity

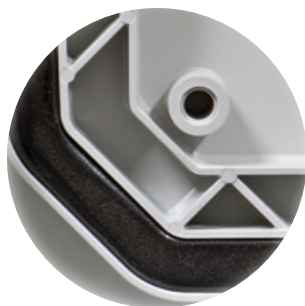

Wide gasket and moulded ribs for better stability and ingress protection

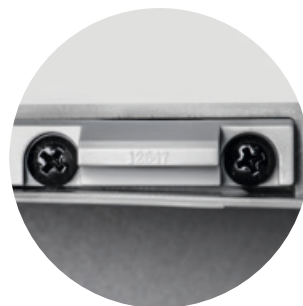

Door guide for secure closing

ACCESSORIES

Dimensions	Mounting plate plain Galvanized steel 2 mm		Mounting plate perforated 26 x 11 mm, Galvanized steel 2 mm		Mounting plate multiperforated ø 3,6 mm, Galvanized steel 2 mm		For cabinet
	Code	Symbol	Code	Symbol	Code	Symbol	
250 x 150	8120731	MPS ARCA 3020	8120751	MPP ARCA 3020	8120920	MPMP ARCA 3020	ARCA 302015
350 x 250	8120733	MPS ARCA 4030	8120753	MPP ARCA 4030	8120922	MPMP ARCA 4030	ARCA 403015
350 x 250	8120733	MPS ARCA 4030	8120753	MPP ARCA 4030	8120922	MPMP ARCA 4030	ARCA 403021
450 x 350	8120735	MPS ARCA 5040	8120755	MPP ARCA 5040	8120924	MPMP ARCA 5040	ARCA 504021
550 x 350	8120736	MPS ARCA 6040	8120756	MPP ARCA 6040	8120925	MPMP ARCA 6040	ARCA 604021
630 x 430	8120738	MPS ARCA 7050	8120758	MPP ARCA 7050	8120927	MPMP ARCA 7050	ARCA 705030
730 x 530	8120739	MPS ARCA 8060	8120759	MPP ARCA 8060	8120928	MPMP ARCA 8060	ARCA 806030
250 x 150	8120731	MPS ARCA 3020	8120930	MPP ARCA 2030	8120920	MPMP ARCA 3020	ARCA 203015
350 x 250	8120733	MPS ARCA 4030	8120931	MPP ARCA 3040	8120922	MPMP ARCA 4030	ARCA 304015
350 x 250	8120733	MPS ARCA 4030	8120931	MPP ARCA 3040	8120922	MPMP ARCA 4030	ARCA 304021
450 x 350	8120735	MPS ARCA 5040	8120932	MPP ARCA 4050	8120924	MPMP ARCA 5040	ARCA 405021
550 x 350	8120736	MPS ARCA 6040	8120933	MPP ARCA 4060	8120925	MPMP ARCA 6040	ARCA 406021
630 x 430	8120738	MPS ARCA 7050	8120934	MPP ARCA 5070	8120927	MPMP ARCA 7050	ARCA 507030
730 x 530	8120739	MPS ARCA 8060	8120935	MPP ARCA 6080	8120928	MPMP ARCA 8060	ARCA 608030

DIN rail set			Inner door set		Pole mounting kit for pole ø100 - ø300 mm		
Code	Symbol	Description	Code	Symbol	Code	Symbol	For cabinet
8120760	DRS ARCA 302015	1 row x 5 modules	8120711	IDS ARCA 3020	8120840	PMK ARCA 20	ARCA 302015
8120764	DRS ARCA 403015	2 rows x 11 modules	8120713	IDS ARCA 4030	8120841	PMK ARCA 30	ARCA 403015
8120765	DRS ARCA 403021	2 rows x 11 modules	8120713	IDS ARCA 4030	8120841	PMK ARCA 30	ARCA 403021
8120769	DRS ARCA 504021	3 rows x 16 modules	8120715	IDS ARCA 5040	8120842	PMK ARCA 40	ARCA 504021
8120770	DRS ARCA 604021	3 rows x 16 modules	8120716	IDS ARCA 6040	8120842	PMK ARCA 40	ARCA 604021
8120775	DRS ARCA 705030	4 rows x 21 modules	8120718	IDS ARCA 7050	8120843	PMK ARCA 50	ARCA 705030
8120777	DRS ARCA 806030	4 rows x 26 modules	8120719	IDS ARCA 8060	8120844	PMK ARCA 60	ARCA 806030
8120791	DRS ARCA 203015	1 row x 11 modules	8120910	IDS ARCA 2030	8120841	PMK ARCA 30	ARCA 203015
8120793	DRS ARCA 304015	1 row x 16 modules	8120911	IDS ARCA 3040	8120842	PMK ARCA 40	ARCA 304015
8120794	DRS ARCA 304021	1 row x 16 modules	8120911	IDS ARCA 3040	8120842	PMK ARCA 40	ARCA 304021
8120796	DRS ARCA 405021	2 rows x 22 modules	8120912	IDS ARCA 4050	8120843	PMK ARCA 50	ARCA 405021
8120797	DRS ARCA 406021	2 rows x 27 modules	8120913	IDS ARCA 4060	8120844	PMK ARCA 60	ARCA 406021
8120790	DRS ARCA 507030	3 rows x 32 modules	8120914	IDS ARCA 5070	8120845	PMK ARCA 70	ARCA 507030
8120800	DRS ARCA 608030	3 rows x 37 modules	8120915	IDS ARCA 6080	8120846	PMK ARCA 80	ARCA 608030



Lock inserts

Code	Symbol	Description
8120860	LIS ARCA DB3	Locking insert Double-bit 3 mm for ARCA 2030 up to 6040
8120980	LIS ARCA DB3 MID	Locking insert Double-bit 3 mm for ARCA 5070 up to 8060
8120861	LIS ARCA S7	Locking insert Square 7 mm for ARCA 2030 up to 6040
8120981	LIS ARCA S7 MID	Locking insert Square 7 mm for ARCA 5070 up to 8060
8120862	LIS ARCA S8	Locking insert Square 8 mm for ARCA 2030 up to 6040
8120982	LIS ARCA S8 MID	Locking insert Square 8 mm for ARCA 5070 up to 8060
8120863	LIS ARCA T8	Locking insert Triangular 8 mm for ARCA 2030 up to 6040
8120983	LIS ARCA T8 MID	Locking insert Triangular 8 mm for ARCA 5070 up to 8060
8120865	LIS ARCA 1242E wingknob	Locking 1242E system for ARCA 2030 up to 6040
8120985	LIS ARCA 1242E MID wingknob	Locking 1242E system for ARCA 5070 up to 8060
8120866	LIS ARCA V2432E wingknob	Locking V2432E system for ARCA 2030 up to 6040
8120986	LIS ARCA V2432E MID wingknob	Locking V2432E system for ARCA 5070 up to 8060
8120867	LIS ARCA 455E wingknob	Locking 455E system for ARCA 2030 up to 6040
8120987	LIS ARCA 455E MID wingknob	Locking 455E system for ARCA 5070 up to 8060
8120868	LIS ARCA 405E wingknob	Locking 405E system for ARCA 2030 up to 6040
8120988	LIS ARCA 405E MID wingknob	Locking 405E system for ARCA 5070 up to 8060

Corner adjustment sets

Code	Symbol	Description
8120810	CBS ARCA 15	Corner adjustment set for sizes with depth 150
8120811	CBS ARCA 21	Corner adjustment set for sizes with depth 210
8120812	CBS ARCA 30	Corner adjustment set for sizes with depth 300

Wall mounting lugs set

Code	Symbol	Description
8120830	WMK ARCA 10 SMALL	Wall mounting lugs set adds 10 mm between wall and cabinet
8120831	WMK ARCA 40 SMALL	Wall mounting lugs set adds 40 mm between wall and cabinet
8120904	WMK ARCA 10 MID	Wall mounting lugs set for 5070-8060 adds 10 mm between wall and cabinet
8120905	WMK ARCA 40 MID	Wall mounting lugs set for 5070-8060 adds 40 mm between wall and cabinet
8120832	WMKQ10S	Plastic Wall mounting lugs set adds 10 mm between wall and cabinet
8120833	WMKQ50S	Plastic Wall mounting lugs set adds 50 mm between wall and cabinet
8120834	WMKQ10M	Plastic Wall mounting lugs set for 5070-8060 adds 10 mm between wall and cabinet
8120835	WMKQ50M	Plastic Wall mounting lugs set for 5070-8060 adds 50 mm between wall and cabinet

Half cylinder locks for swinghandle

Code	Symbol	Description
8120870	CLI ARCA DB3	Half cylinder locking Double-bit 3 mm
8120871	CLI ARCA S7	Half cylinder locking Square 7 mm
8120872	CLI ARCA S8	Half cylinder locking Square 8 mm
8120873	CLI ARCA T8	Half cylinder locking Triangular 8 mm
8120875	CLI ARCA 1242E	Half cylinder locking 1242E system
8120876	CLI ARCA V2432E	Half cylinder locking V2432E system
8120877	CLI ARCA 455E	Half cylinder locking 455E system
8120878	CLI ARCA 405E	Half cylinder locking 405E system

Coupling flange

Code	Symbol	Description
8120820	CFS ARCA	Coupling Flange for connecting cabinets

Hinge sets

Code	Symbol	Description
8120891	FHS S ARCA	Hinge set small for sizes 200 x 300 - 600 x 400
8120892	FHS M ARCA	Hinge set medium for sizes 500 x 700 - 800 x 600

CAB

WITHSTANDS SUDDEN IMPACTS

If you need major impact resistance, then CAB may be the cabinet for you. Think of the harshest and most demanding environments – CAB will not let you down. It will resist weathering and take the knocks better than steel. A wide selection is available.

PC: IP 65; IK 08

ABS: IP 65; IK 08

GRP (CAB P): IP 66; IK 10 (grey door)



DIMENSIONS:

200 x 300 x 180 mm – 600 x 400 x 220 mm (CAB PC/ABS)

315 x 215 x 170 mm – 1035 x 835 x 300 mm (CAB P)

SIZES AND PRODUCT VERSIONS

Dimensions	Cabinet, PC grey door latch		Cabinet, PC grey door lock		Cabinet, PC smoked transparent door latch		Cabinet, PC smoked transparent door lock		Cabinet, ABS grey door latch		Cabinet, Polyester grey door lock	
	Code	Symbol	Code	Symbol	Code	Symbol	Code	Symbol	Code	Symbol	Code	Symbol
200 x 300 x 180	8113331	CAB PC 203018 G	8113334	CAB PC 203018 G3B	8113031	CAB PC 203018 T	8113036	CAB PC 203018 T3B				
300 x 200 x 180	8113330	CAB PC 302018 G	8113332	CAB PC 302018 G3B	8113030	CAB PC 302018 T	8113032	CAB PC 302018 T3B	8183330	CAB ABS 302018 G		
300 x 300 x 180	8113340	CAB PC 303018 G	8113342	CAB PC 303018 G3B	8113040	CAB PC 303018 T	8113042	CAB PC 303018 T3B	8183340	CAB ABS 303018 G		
300 x 400 x 180	8113351	CAB PC 304018 G	8113354	CAB PC 304018 G3B	8113051	CAB PC 304018 T	8113054	CAB PC 304018 T3B				
315 x 215 x 170											8104303	CAB P 302017
400 x 300 x 180	8113350	CAB PC 403018 G	8113352	CAB PC 403018 G3B	8113050	CAB PC 403018 T	8113052	CAB PC 403018 T3B	8183350	CAB ABS 403018 G		
400 x 500 x 200	8113361	CAB PC 405020 G	8113364	CAB PC 405020 G3B	8113061	CAB PC 405020 T	8113064	CAB PC 405020 T3B				
415 x 315 x 170											8104304	CAB P 403017
500 x 400 x 200	8113360	CAB PC 504020 G	8113362	CAB PC 504020 G3B	8113060	CAB PC 504020 T	8113062	CAB PC 504020 T3B				
515 x 415 x 230											8104305	CAB P 504023
600 x 400 x 220	8113370	CAB PC 604022 G	8113372	CAB PC 604022 G3B	8113070	CAB PC 604022 T	8113072	CAB PC 604022 T3B				
615 x 415 x 230											8104306	CAB P 604023
735 x 535 x 270											8104307	CAB P 705027
835 x 635 x 300											8104308	CAB P 806030
1035 x 835 x 300											8104309	CAB P 1008030

Product group	Control unit/cabinet	Power distribution unit/cabinet	Power distribution board	Terminal enclosure	Junction box	Instrumentation	Electronic devices
CAB	●	–	–	–	–	–	–

ACCESSORIES

Mounting plate - CAB PC/ABS (Galvanized steel, 2 mm)

Dimensions	Code	Symbol	For enclosures
170 x 270	4712117	EKIV 23	CAB 203018, CAB 302018
270 x 270	4712118	EKIV 33	CAB 303018
370 x 270	4712119	EKIV 43	CAB 304018, CAB 403018
470 x 370	8392230	EKIV 54	CAB 405020, CAB 504020
570 x 370	4712300	EKIV 64H	CAB 604022

Front plates (Aluminium, 1,5 mm) - CAB PC/ABS

Dimensions	Code	Symbol	For enclosures
166 x 268	8392226	FP A 23	CAB 203018
266 x 268	8392227	FP A 23	CAB 302018
266 x 268	8392227	FP A 33	CAB 303018
266 x 368	8392224	FP A 43	CAB 304018, CAB 403018

DIN-35 Mounting rails - CAB PC/ABS, (Galvanized steel, rail height 7,5 mm)

Dimensions	Code	Symbol	For enclosures
35 x 166	4712126	EKIV 17	CAB 203018, CAB 302018
35 x 266	4712127	EKIV 27	CAB 303018, CAB 304018, CAB 403018, CAB 203018, CAB 302018
35 x 366	4712128	EKIV 37	CAB 405020, CAB 504020, CAB 604022, CAB 304018, CAB 403018
35 x 466	8392231	EKIV 47	CAB 405020, CAB 504020

Mounting plate - CAB P (Galvanized steel, 2 mm)

Dimensions	Code	Symbol	For enclosures
250 x 150	8203020	MP 3020	CAB P 302017
350 x 250	8204030	MP 4030	CAB P 403017
450 x 350	8205040	MP 5040	CAB P 504023
550 x 350	8206040	MP 6040	CAB P 604023
650 x 450	8207050	MP 7050	CAB P 705027
750 x 550	8208060	MP 8060	CAB P 806030
950 x 750	8200080	MP 10080	CAB P 1008030

Front plate - CAB P

Dimensions	Code	Symbol	For enclosures
250 x 150	8273020	FP 3020-D	CAB P 302017
350 x 250	8274030	FP 4030-D	CAB P 403017
450 x 350	8275040	FP 5040-D	CAB P 504023
550 x 350	8276040	FP 6040-D	CAB P 604023
650 x 450	8277050	FP 7050-D	CAB P 705027
750 x 550	8278060	FP 8060-D	CAB P 806030
950 x 750	8270080	FP 10080-D	CAB P 1008030

Other accessories

Code	Symbol	For enclosures	Description
8390007	MB 12225 AL	CAB PC/ABS	Swing door set for aluminium front plates
4712045	FP 12017	CAB PC/ABS	Wall fastening lug (4 pcs.) incl. screws
3730686	MB 10686	CAB PC/ABS	Set of 2 spacers including screws (15/34 mm)
8280001	MB CAB	CAB P	Swing door kit
8280002	MF CAB	CAB P	Wall fastening lug kit (4 lugs, stainless)
8280003	TF CAB	CAB P	Wall fastening lug kit (4 lugs, polyamide)

Impact-resistant material.

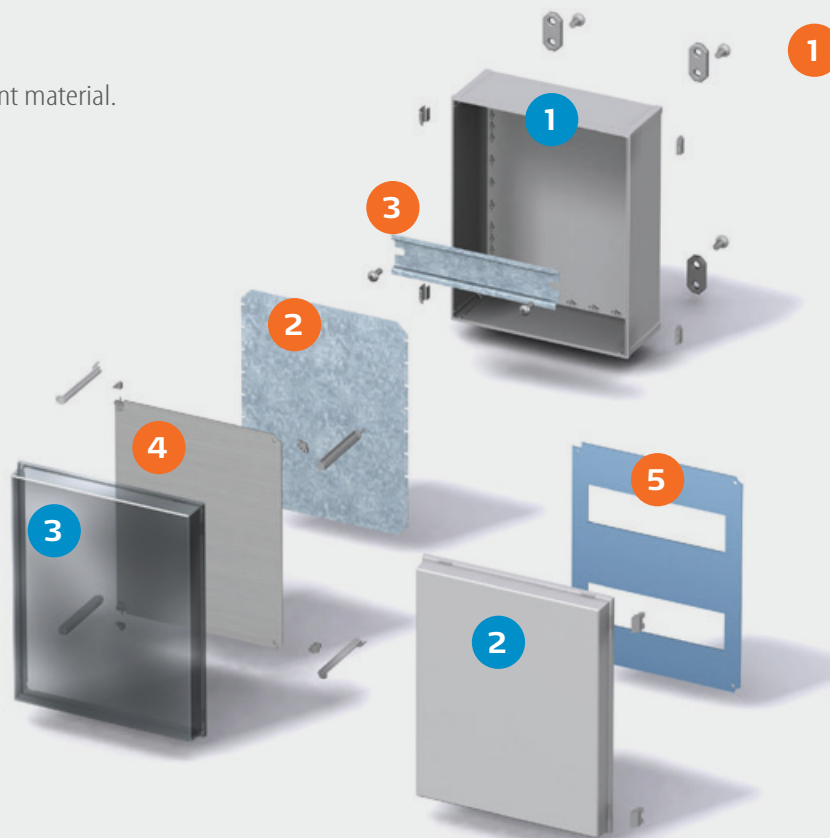

ENCLOSURE:

- 1 Enclosure base
- 2 Cover, grey incl. PUR gasket
- 3 Cover, transparent
Hinges on the long/short side



ACCESSORIES:

- 1 Fastening lugs (4 pcs.) incl. screws
Hinge set for CAB/Quick, corner plug
- 2 Mounting plate, electro-galvanised steel
- 3 DIN rail TS 35
- 4 Pivotal front plate, aluminium with mounting kit
- 5 Front plate has flexible opening and depth mounting options

Including:

Cabinet base, door with PUR gasket, 3 mm double bit lock(s) with transport and plastic key or latches.

OFFERS HUGE OPTIONS

This range offers over 260 versions. Choose MNX if you have a large product family that needs to be housed in matching enclosures with the minimum of fuss, no matter the environment or installation height. For the protection of electrical and electronic components of all kinds.

PC: IP 66/67; IK 08

ABS: IP 66/67; IK 07



DIMENSIONS:

100 x 100 x 35 mm – 360 x 255 x 152 mm

SIZES AND PRODUCT VERSIONS

Dimensions	Polycarbonate grey cover		Polycarbonate transparent cover		Polycarbonate metric knock-outs, grey cover		Polycarbonate, metric knock-outs, transparent cover		ABS grey cover	
	Code	Symbol	Code	Symbol	Code	Symbol	Code	Symbol	Code	Symbol
100x100 x 35	6012331	PC 95/35 LG	6012931	PC 95/35 LT						
100x100 x 50	6012332	PC 95/50 LG	6012932	PC 95/50 LT						
100x100 x 60	6011331	PC 95/60 HG			6016331	PCM 95/60 G			6081331	ABS 95/60 HG
100x100 x 75	6011332	PC 95/75 HG			6016332	PCM 95/75 G			6081332	ABS 95/75 HG
130x 80 x 35	6012301	PC 100/35 LG	6012901	PC 100/35 LT						
130x 80 x 50	6012302	PC 100/50 LG	6012902	PC 100/50 LT						
130x 80 x 100	6012304	PC 100/100 LG								
130x 80 x 60	6011301	PC 100/60 HG	6011901	PC 100/60 HT	6016301	PCM 100/60 G				
130x 80 x 75	6011302	PC 100/75 HG	6011902	PC 100/75 HT	6016302	PCM 100/75 G	6016902	PCM 100/75 T		
130x 80 x 100	6011303	PC 100/100 HG			6016303	PCM 100/100 G	6016903	PCM 100/100 T		
130x 80 x 125	6011304	PC 100/125 HG			6016304	PCM 100/125 G	6016904	PCM 100/125 T		
130x130 x 35	6012307	PC 125/35 LG	6012907	PC 125/35 LT						
130x130 x 50	6012308	PC 125/50 LG								
130x130 x 100	6012310	PC 125/100 LG								
130x130 x 60	6011307	PC 125/60 HG	6011907	PC 125/60 HT	6016307	PCM 125/60 G	6016907	PCM 125/60 T	6081307	ABS 125/60 HG
130x130 x 75	6011308	PC 125/75 HG	6011908	PC 125/75 HT	6016308	PCM 125/75 G	6016908	PCM 125/75 T	6081308	ABS 125/75 HG
130x130 x 100	6011309	PC 125/100 HG	6011909	PC 125/100 HT	6016309	PCM 125/100 G	6016909	PCM 125/100 T	6081309	ABS 125/100 HG
130x130 x 125	6011310	PC 125/125 HG	6011910	PC 125/125 HT	6016310	PCM 125/125 G	6016910	PCM 125/125 T	6081310	ABS 125/125 HG
180x130 x 35	6012313	PC 150/35 LG	6012913	PC 150/35 LT						
180x130 x 50	6012314	PC 150/50 LG	6012914	PC 150/50 LT						
180x130 x 60	6011313	PC 150/60 HG	6011913	PC 150/60 HT	6016313	PCM 150/60 G	6016913	PCM 150/60 T	6081313	ABS 150/60 HG
180x130 x 75	6011314	PC 150/75 HG	6011914	PC 150/75 HT	6016314	PCM 150/75 G	6016914	PCM 150/75 T	6081314	ABS 150/75 HG
180x130 x 100	6011315	PC 150/100 HG	6011915	PC 150/100 HT	6016315	PCM 150/100 G	6016915	PCM 150/100 T	6081315	ABS 150/100 HG
180x130 x 125	6011316	PC 150/125 HG			6016316	PCM 150/125 G	6016916	PCM 150/125 T	6081316	ABS 150/125 HG
180x130 x 150	6011317	PC 150/150 HG	6011917	PC 150/150 HT	6016317	PCM 150/150 G	6016917	PCM 150/150 T		
180x130 x 85	6013333	PC 150/85 XHG			6016333	PCM 150/85 XG				
180x130 x 100	6013334	PC 150/100 XHG								
180x180 x 60	6011319	PC 175/60 HG	6011919	PC 175/60 HT	6016319	PCM 175/60 G			6081319	ABS 175/60 HG
180x180 x 75	6011320	PC 175/75 HG	6011920	PC 175/75 HT	6016320	PCM 175/75 G	6016920	PCM 175/75 T	6081320	ABS 175/75 HG
180x180 x 100	6011321	PC 175/100 HG			6016321	PCM 175/100 G	6016921	PCM 175/100 T	6081321	ABS 175/100 HG
180x180 x 125	6011322	PC 175/125 HG			6016322	PCM 175/125 G	6016922	PCM 175/125 T	6081322	ABS 175/125 HG
180x180 x 150	6011323	PC 175/150 HG	6011923	PC 175/150 HT	6016323	PCM 175/150 G	6016923	PCM 175/150 T	6081323	ABS 175/150 HG
255x180 x 63	6011324	PC 200/63 HG	6011924	PC 200/63 HT	6016324	PCM 200/63 G	6016924	PCM 200/63 T		
255x180 x 75	6011326	PC 200/75 HG	6011926	PC 200/75 HT	6016326	PCM 200/75 G	6016926	PCM 200/75 T		
255x180 x 100	6011327	PC 200/100 HG	6011927	PC 200/100 HT	6016327	PCM 200/100 G	6016927	PCM 200/100 T	6081327	ABS 200/100 HG
255x180 x 150	6011329	PC 200/150 HG	6011929	PC 200/150 HT	6016329	PCM 200/150 G	6016929	PCM 200/150 T	6081329	ABS 200/150 HG
255x180 x 88	6013330	PC 200/88 XHG	6013930	PC 200/88 XHT						
255x180 x 100	6013326	PC 200/100 XHG			6015326	PCM 200/100 XG				
255x180 x 125	6013327	PC 200/125 XHG	6013927	PC 200/125 XHT	6015327	PCM 200/125 XG	6015927	PCM 200/125 XT		
255x180 x 175	6013329	PC 200/175 XHG	6013929	PC 200/175 XHT	6015329	PCM 200/175 XG	6015929	PCM 200/175 XT		
360x255 x 152	6017338	PC 300/150 ZG	6017938	PC 300/150 ZT						

L = low base, 25 mm

H = high base, 50 mm

XH = extra high base, 75 mm

Z = extra high base, 100 mm

Product group	Control unit/cabinet	Power distribution unit/cabinet	Power distribution board	Terminal enclosure	Junction box	Instrumentation	Electronic devices
MNX	–	–	–	•	–	•	•

ACCESSORIES

Mounting plates (Galvanized steel, 1,5 mm)

Dimensions	Code	Symbol	For enclosures
66 x 80	5514583	MIV 95	PC / PCM / ABS 95
98 x 48	5514076	MIV 100	PC / PCM / ABS 100
98 x 98	5514077	MIV 125	PC / PCM / ABS 125
148 x 98	5514078	MIV 150	PC / PCM / ABS 150
148 x 148	5514079	MIV 175	PC / PCM / ABS 175
223 x 148	5514080	MIV 200	PC / PCM / ABS 200
330 x 225	5514585	MIV 300	PC / PCM / ABS 300

DIN-rail, 35 mm, long (Galvanized steel)

Dimensions	Code	Symbol	For enclosures
80 x 35	8524030	B-3	PC / PCM / ABS 95
100 x 35	5514082	MIV 10	PC / PCM / ABS 100
100 x 35	5514082	MIV 10	PC / PCM / ABS 125
150 x 35	5514083	MIV 15	PC / PCM / ABS 150
150 x 35	5514083	MIV 15	PC / PCM / ABS 175
225 x 35	5514084	MIV 20	PC / PCM / ABS 200
329 x 35	5514586	MIV 30	PC / PCM / ABS 300

Other accessories

Code	Symbol	Description
8522346	FP 22046	Wall fastening lugs (4 pcs.) incl. screws
9802001	TH A	Grey plastic hinges (2 pcs.) incl. mounting screws

DIN-rail, 35 mm, short (Galvanized steel)

Dimensions	Code	Symbol	For enclosures
50 x 35	5514081	MIV 5	PC / PCM / ABS 100
100 x 35	5514082	MIV 10	PC / PCM / ABS 150
150 x 35	5514083	MIV 15	PC / PCM / ABS 200
225 x 35	5514084	MIV 20	PC / PCM / ABS 300

Easy-to-use solutions and functionality. Designed to house automation, control and switch gear components. Modular height system.

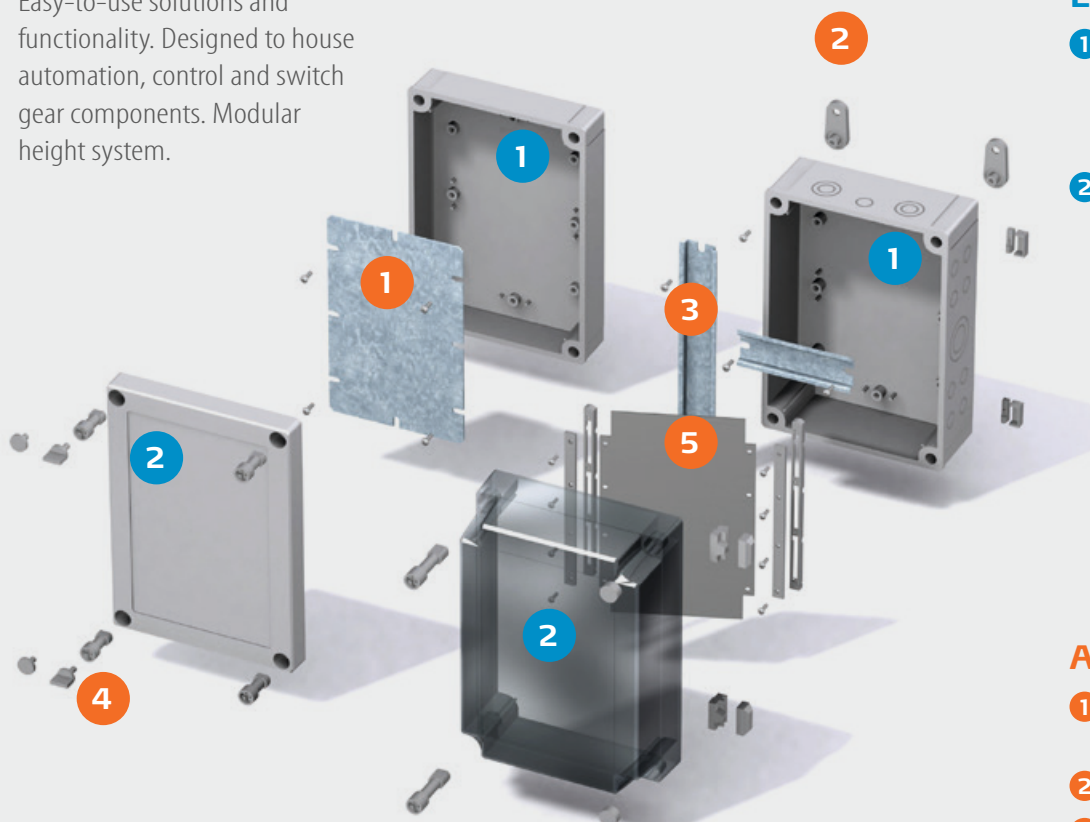

Including:

Enclosures include: Base with screws for mounting plate, cover with PUR gasket and polyamide cover screws.

ENCLOSURE:

- 1 PC or ABS enclosure, different heights, optionally also available with metric knockouts to assure a quick fitting assembly
- 2 PC cover, grey or smoked transparent



ACCESSORIES:

- 1 Mounting plate, Electro-galvanised steel
- 2 Fastening lugs (4 pcs.) incl. screws
- 3 DIN rail TS 15/TS 35
- 4 Cover screws, various versions
- 5 Pivotal front plate, aluminium

EK

FOR MODULAR FLEXIBILITY

Because EK enclosures are fully modular, this range stretches to fit, from a single module to extensive enclosure panels. EK comes in a large size range, with various depths and a host of accessories.

PC: IP 66/67; IK 08 (side surface); IK 09 (front surface)

DIMENSIONS:

190 x 190 x 130 mm – 760 x 560 x 250 mm



Modular structure for larger enclosure panels

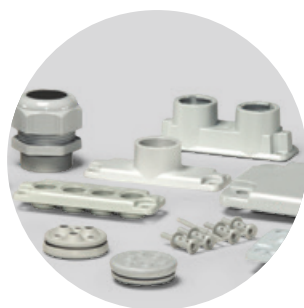

Wide accessory selection



Extension frame multiplies usage options

SIZES AND PRODUCT VERSIONS

Dimensions	Polycarbonate grey cover		Polycarbonate transparent cover	
	Code	Symbol	Code	Symbol
190 x 190 x 130	2538001	EKHA 130 G	2538101	EKHA 130 T
190 x 190 x 180	2538004	EKHA 180 G	2538104	EKHA 180 T
280 x 190 x 130	2538013	EKJB 130 G	2538113	EKJB 130 T
280 x 190 x 180	2538016	EKJB 180 G	2538116	EKJB 180 T
380 x 190 x 130	2538019	EKMB 130 G	2538119	EKMB 130 T
380 x 190 x 180	2538022	EKMB 180 G	2538122	EKMB 180 T
280 x 280 x 130	2538037	EKOE 130 G	2538137	EKOE 130 T
280 x 280 x 180	2538040	EKOE 180 G	2538140	EKOE 180 T
380 x 280 x 130	2538043	EKPE 130 G	2538143	EKPE 130 T
380 x 280 x 180	2538046	EKPE 180 G	2538146	EKPE 180 T
380 x 280 x 180	2538055	EKPK 180 G	2538155	EKPK 180 T
380 x 280 x 230	2538058	EKPK 230 G	2538158	EKPK 230 T
380 x 280 x 180	2538061	EKPL 180 G	2538161	EKPL 180 T
380 x 280 x 230	2538064	EKPL 230 G	2538164	EKPL 230 T
560 x 280 x 130	2538067	EKTH 130 G	2538167	EKTH 130 T
560 x 380 x 180	2538073	EKUH 180 G	2538173	EKUH 180 T
560 x 380 x 180	2538079	EKUM 180 G	2538179	EKUM 180 T
560 x 380 x 180	2538085	EKUN 180 G	2538185	EKUN 180 T
760 x 560 x 250	2538990	EKWH 250 G NEW		

Product group	Control unit/cabinet	Power distribution unit/cabinet	Power distribution board	Terminal enclosure	Junction box	Instrumentation	Electronic devices
EK	●	●	●	●	–	–	–

ACCESSORIES

Mounting plate plain (Galvanized steel, 1,5 mm)

Dimensions	Code	Symbol	For enclosures
158 x 158	3770548	EKHVT	EKH
238 x 158	3770549	EKJVT	EKJ
338 x 158	3770550	EKMVT	EKM
238 x 238	3770551	EKOVT	EKO
338 x 238	3770552	EKPVT	EKP
518 x 238	3770553	EKTVT	EKT
518 x 338	3770554	EKUVT	EKU
518 x 338	2 x 3770554	2 x EKUVT	EKW

DIN-rail 35 mm, short (Galvanized steel)

Dimensions	Code	Symbol	For enclosures
160 x 35	3770647	EKV 12	EKJ
160 x 35	3770647	EKV 12	EKM
235 x 35	3770648	EKV 22	EKP
235 x 35	3770648	EKV 22	EKT

Other accessories

Code	Symbol	Description
3770674	MB 10674	Wall fastening lugs (4 pcs.) incl. screws
3530622	MB 10622	Grey plastic hinges (2 pcs.) incl. mounting screws

Depth extension frame (Polycarbonate)

Dimensions	Code	Symbol	For enclosures
280 x 190 x 50	3730153	EKJZR	EKJ
380 x 190 x 50	3730152	EKMZR	EKM
280 x 280 x 50	3730093	EKOZR	EKO
380 x 280 x 50	3730141	EKPZR	EKP
560 x 280 x 50	3730142	EKTZR	EKT
560 x 380 x 50	3730323	EKUZR	EKU

DIN-rail 35 mm, long (Galvanized steel)

Dimensions	Code	Symbol	For enclosures
160 x 35	3770647	EKV 12	EKH
235 x 35	3770648	EKV 22	EKJ
335 x 35	3770649	EKV 32	EKM
235 x 35	3770648	EKV 22	EKO
335 x 35	3770649	EKV 32	EKP
500 x 35	3770699	EKV 50	EKT

Selection of flange plates and cover plates — see pages 34 and 35.

Ideal for single or modular enclosure solutions.
Wide selection and extensive range of accessories.

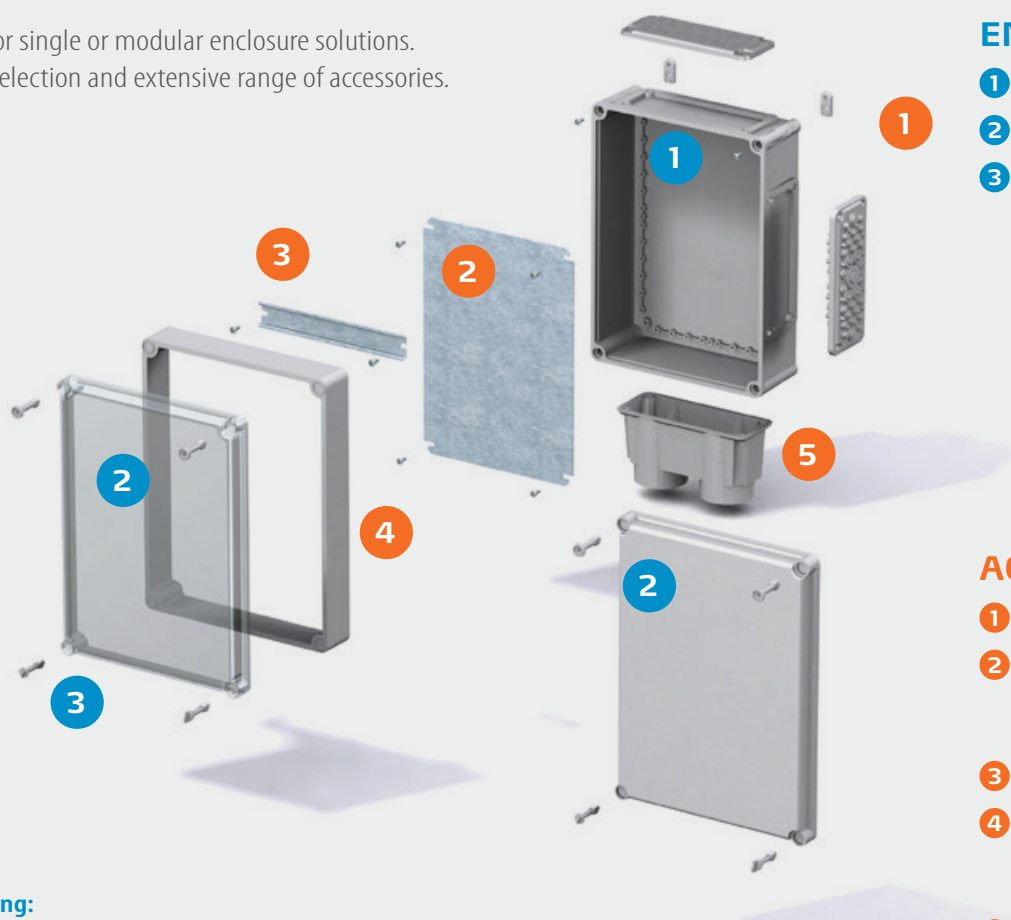

ENCLOSURE:

- 1 Base
- 2 Cover, grey or transparent
- 3 Cover screws, various versions

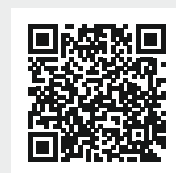

ACCESSORIES:

- 1 Fastening lugs (2 pcs.) incl. screws
- 2 Mounting plate, electro-galvanized steel, stable and impact-resistant
- 3 DIN rail different sizes TS 35
- 4 Intermediate frame, polycarbonate, (from size 2819) PUR gasket (height 50 mm)
- 5 Membrane cable gland for flexible applications

Including:

Enclosures include: Base with screws for mounting plate, cover with PUR gasket and polyamide cover screws.

SOLID

SOLID PROTECTION

Solid is the superb all-rounder, both in and out of doors. If you need general protection, in everyday environments, Solid may be the all-purpose solution you are seeking for electronic and electrical components.

PC: IP 66/67; IK 08 (side surface), IK 09 (front surface)

ABS: IP 66/67; IK 08



DIMENSIONS:

190 x 190 x 130 mm – 760 x 560 x 250 mm.



Wide opening hinges +180°
for easy access



Guaranteed long-term ingress protection –
no holes required in enclosure

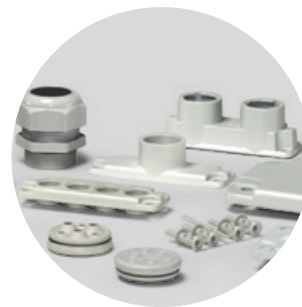

Wide accessory selection

SIZES AND PRODUCT VERSIONS

Dimensions	Polycarbonate grey cover		Polycarbonate transparent cover		Polycarbonate grey hinged cover		Polycarbonate, transparent hinged cover		ABS grey cover	
	Code	Symbol	Code	Symbol	Code	Symbol	Code	Symbol	Code	Symbol
190 x 190 x 130	5330359	PC 1919 13 G	5330059	PC 1919 13 T	2539505	PC 1919 13 G-2FSH	2539535	PC 1919 13 T-2FSH	5880359	ABS 1919 13 G
190 x 190 x 180	5330369	PC 1919 18 G	5330069	PC 1919 18 T	2539507	PC 1919 18 G-2FSH	2539537	PC 1919 18 T-2FSH		
280 x 190 x 130	5330360	PC 2819 13 G	5330060	PC 2819 13 T	2539509	PC 2819 13 G-2FSH	2539539	PC 2819 13 T-2FSH	5880360	ABS 2819 13 G
280 x 190 x 180	5330370	PC 2819 18 G	5330070	PC 2819 18 T	2539511	PC 2819 18 G-2FSH	2539541	PC 2819 18 T-2FSH		
280 x 280 x 130	5330362	PC 2828 13 G	5330062	PC 2828 13 T	2539517	PC 2828 13 G-2FSH	2539547	PC 2828 13 T-2FSH	5880362	ABS 2828 13 G
280 x 280 x 180	5330372	PC 2828 18 G	5330072	PC 2828 18 T	2539519	PC 2828 18 G-2FSH	2539549	PC 2828 18 T-2FSH	5880372	ABS 2828 18 G
380 x 190 x 130	5330361	PC 3819 13 G	5330061	PC 3819 13 T	2539513	PC 3819 13 G-2FSH	2539543	PC 3819 13 T-2FSH	5880361	ABS 3819 13 G
380 x 190 x 180	5330371	PC 3819 18 G	5330071	PC 3819 18 T	2539515	PC 3819 18 G-2FSH	2539545	PC 3819 18 T-2FSH		
380 x 280 x 130	5330363	PC 3828 13 G	5330063	PC 3828 13 T	2539521	PC 3828 13 G-2FSH	2539551	PC 3828 13 T-2FSH	5880363	ABS 3828 13 G
380 x 280 x 180	5330373	PC 3828 18 G	5330073	PC 3828 18 T	2539523	PC 3828 18 G-2FSH	2539553	PC 3828 18 T-2FSH	5880373	ABS 3828 18 G
560 x 280 x 130	5330364	PC 5628 13 G	5330064	PC 5628 13 T	2539525	PC 5628 13 G-3FSH	2539555	PC 5628 13 T-3FSH		
560 x 380 x 180	5330365	PC 5638 18 G	5330065	PC 5638 18 T	2539527	PC 5638 18 G-3FSH	2539557	PC 5638 18 T-3FSH		
760 x 560 x 250	5330390	PC 7656 25 G								

Product group	Control unit/cabinet	Power distribution unit/cabinet	Power distribution board	Terminal enclosure	Junction box	Instrumentation	Electronic devices
SOLID	●	●	–	●	–	–	–

ACCESSORIES

Mounting plates (Galvanized steel, 1,5 mm)

Dimensions	Code	Symbol	For enclosures
158 x 158	3770548	EKHVT	PC / ABS 1919
238 x 158	3770549	EKJVT	PC / ABS 2819
338 x 158	3770550	EKMVT	PC / ABS 3819
238 x 238	3770551	EKOVT	PC / ABS 2828
338 x 238	3770552	EKPVT	PC / ABS 3828
518 x 238	3770553	EKTVT	PC / ABS 5628
518 x 338	3770554	EKUVT	PC / ABS 5638
518 x 338	2x3770554	2x EKUVT	PC 7656

DIN-rail 35 mm, long (Galvanized steel)

Dimensions	Code	Symbol	For enclosures
160 x 35	3770647	EKV 12	PC / ABS 1919
235 x 35	3770648	EKV 22	PC / ABS 2819
335 x 35	3770649	EKV 32	PC / ABS 3819
235 x 35	3770648	EKV 22	PC / ABS 2828
335 x 35	3770649	EKV 32	PC / ABS 3828
500 x 35	3770699	EKV 50	PC / ABS 5628

Other accessories

Code	Symbol	Description
3770674	MB 10674	Wall fastening lugs (4 pcs.) incl. screws
3530622	MB 10622	Grey plastic hinges (2 pcs.) incl. mounting screws

Depth extension frame (Polycarbonate)

Dimensions	Code	Symbol	For enclosures
280 x 190 x 50	3730153	EKJZR	PC / ABS 2819
380 x 190 x 50	3730152	EKMZR	PC / ABS 3819
280 x 280 x 50	3730093	EKOZR	PC / ABS 2828
380 x 280 x 50	3730141	EKPZR	PC / ABS 3828
560 x 280 x 50	3730142	EKTZR	PC / ABS 5628
560 x 380 x 50	3730323	EKUZR	PC / ABS 5638

DIN-rail 35 mm, short (Galvanized steel)

Dimensions	Code	Symbol	For enclosures
160 x 35	3770647	EKV 12	PC / ABS 2819
160 x 35	3770647	EKV 12	PC / ABS 3819
235 x 35	3770648	EKV 22	PC / ABS 3828
235 x 35	3770648	EKV 22	PC / ABS 5628

The ideal alternative to polyester enclosures. With hinged or screw cover/polycarbonate/ABS.

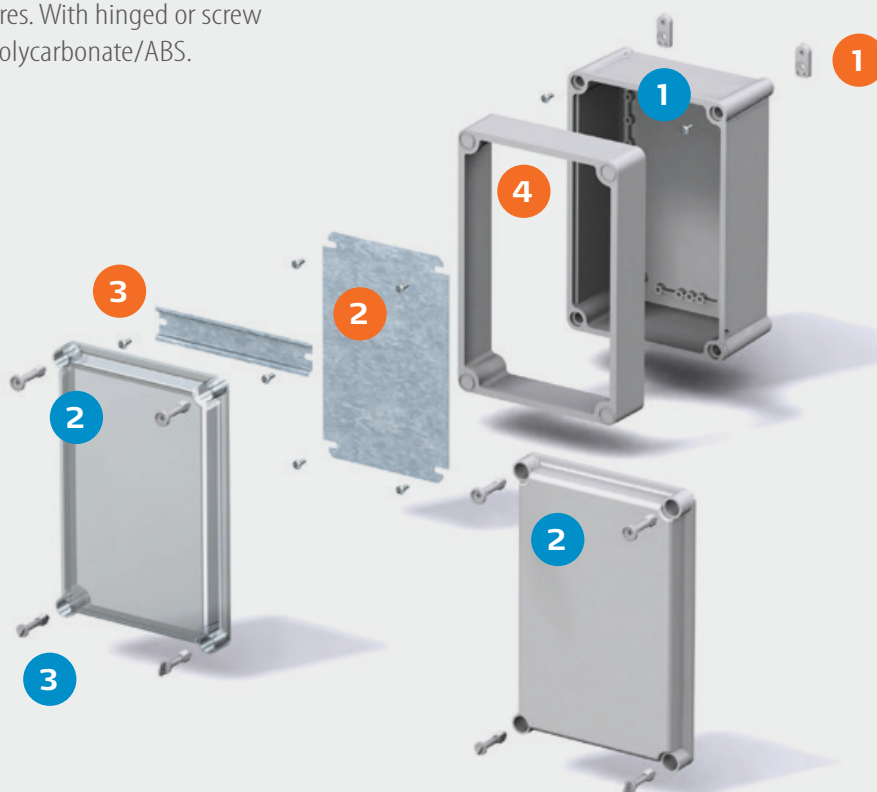

ENCLOSURE:

- 1 Base
- 2 Cover, grey or transparent
- 3 Cover screws, various versions

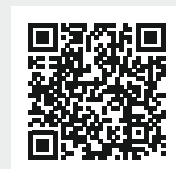

ACCESSORIES:

- 1 Fastening lugs (2 pcs.) incl. screws
- 2 Mounting plate, electro-galvanised steel, stable and impact-resistant
- 3 DIN rail with mounting screws
- 4 Extension frame

Including:

Enclosures include: Base with screws for mounting plate, cover with PUR gasket and polyamide cover screws.

EURONORD

BRINGS INTERCHANGEABILITY

Euronord enclosures come in over 170 standard sizes, meaning huge interchangeability with the products you may already have. The latest addition Euronord 3 range incorporates a number of innovative features, for example quick release corrosion resistant cover screws, and recessed middle area of the cover for membrane keyboards and prints.

PC: IP 66/67; IK 07 (side surface), IK 08 (front surface)

ABS: IP 66/67; IK 07 **P:** IP 66/67; IK 08



DIMENSIONS: 50 x 52 x 40 mm – 360 x 400 x 151 mm

SIZES AND PRODUCT VERSIONS

Dimensions	Polycarbonate grey cover		Polycarbonate transparent cover		Polycarbonate grey cover, quick locking		Polycarbonate, transparent cover, quick locking		ABS grey cover		ABS grey cover, quick locking		Polyester grey cover	
	Code	Symbol	Code	Symbol	Code	Symbol	Code	Symbol	Code	Symbol	Code	Symbol	Code	Symbol
52 x 50 x 40	7032500	PC 050504	7022521	PCT 050705					7083500	AB 050504				
50 x 65 x 45	7032520	PC 050705							7083520	AB 050705				
66 x 98 x 41	7032530	PC 071004							7083530	AB 071004				
80 x 82 x 55	7032540	PC 080806	7022541	PCT 080806					7083540	AB 080806			7094140	P 080806
80 x 82 x 65	7032560	PC 080807	7022561	PCT 080807					7083560	AB 080807				
80 x 82 x 85	7032550	PC 080809												
80 x 82 x 95	7032570	PC 080810												
75 x 110 x 55													7094150	P 081106
80 x 120 x 55	7032580	PC 081206	7022581	PCT 081206					7083580	AB 081206				
80 x 120 x 60	7032590	PC 081206H												
80 x 120 x 85	7032600	PC 081209												
80 x 120 x 90	7032610	PC 081209H												
80 x 160 x 55	7032630	PC 081606	7022631	PCT 081606									7094170	P 081606
80 x 160 x 65	7032620	PC 081607	7022621	PCT 081607					7083620	AB 081607				
80 x 160 x 85	7032650	PC 081609	7022651	PCT 081609					7083650	AB 081609				
80 x 160 x 95	7032640	PC 081610	7022641	PCT 081610					7083640	AB 081610				
75 x 190 x 55													7094190	P 081906
120 x 122 x 65	7032660	PC 121207	7022661	PCT 121207					7083660	AB 121207				
120 x 122 x 75	7032670	PC 121208												
120 x 122 x 90													7094220	P 121209
120 x 122 x 95	7032680	PC 121210	7022681	PCT 121210					7083680	AB 121210				
120 x 122 x 105	7032690	PC 121211												
120 x 160 x 90	7032720	PC 121609	7022721	PCT 121609					7083720	AB 121609				
120 x 160 x 140	7032730	PC 121614	7022731	PCT 121614					7083730	AB 121614				
120 x 200 x 75	7032760	PC 122008	7022761	PCT 122008					7083760	AB 122008				
120 x 200 x 90	7032770	PC 122009	7022771	PCT 122009					7083770	AB 122009			7094240	P 122209
124 x 244 x 102	7032780	PC 122410	7022781	PCT 122410	7035781	PCQ3 122410	7025780	PCTQ3 122410	7083780	AB 122410	7085781	ABQ3 122410		
150 x 201 x 80	7032820	PC 152008	7022821	PCT 152008					7083820	AB 152008				
150 x 340 x 101	7032700	PC 153410			7035701	PCQ3 153410	7025700	PCTQ3 153410	7083700	AB 153410	7085701	ABQ3 153410		
150 x 340 x 121	7032710	PC 153412	7022711	PCT 153412					7083710	AB 153412				
160 x 160 x 90													7094280	P 161609
164 x 244 x 90	7032810	PC 162409	7022811	PCT 162409	7035811	PCQ3 162409	7025810	PCTQ3 162409			7085811	ABQ3 162409		
164 x 244 x 120	7032830	PC 162412	7022831	PCT 162412										
160 x 250 x 90	7032840	PC 162509	7022841	PCT 162509					7083840	AB 162509				
160 x 250 x 125	7032860	PC 162513	7022861	PCT 162513					7083860	AB 162513				
160 x 250 x 150	7032740	PC 162515												
160 x 260 x 90													7094300	P 162609
160 x 360 x 90													7094320	P 163609
160 x 360 x 101	7032750	PC 163610	7022851	PCT 163610	7035751	PCQ3 163610	7025750	PCTQ3 163610	7083750	AB 163610	7085751	ABQ3 163610		
200 x 360 x 120					7035791	PCQ3 203612	7025790	PCTQ3 203612			7085791	ABQ3 203612		
200 x 360 x 151	7032790	PC 203615	7022791	PCT 203615										
230 x 300 x 87	7032870	PC 233009	7022871	PCT 233009					7083870	AB 233009				
230 x 300 x 110	7032890	PC 233011	7022891	PCT 233011					7083890	AB 233011				
250 x 255 x 120													7094370	P 252612
250 x 400 x 120													7094400	P 254012
360 x 400 x 120											7085881	ABQ3 364012		
360 x 400 x 151									7083880	AB 364015				
405 x 400 x 120													7094450	P 404012

Product group	Control unit/cabinet	Power distribution unit/cabinet	Power distribution board	Terminal enclosure	Junction box	Instrumentation	Electronic devices
EURONORD	—	—	—	●	—	●	●

ACCESSORIES

Mounting plates (Galvanized steel, 1,5 mm)

Dimensions	Code	Symbol	For enclosures
26 x 44	9512009	TM 0505	PC / PCT / AB 0505
26 x 57	9512010	TM 0507	PC / PCT / AB 0507
56 x 71	9512011	TM 0808	PC / PCT / AB 0808
71 x 94	9512012	TM 0812	PC / PCT / AB 0812
71 x 134	9512013	TM 0816	PC / PCT / AB 0816
96 x 111	9512014	TM 1212	PC / PCT / AB 1212
111 x 134	9512036	TM 1216	PC / PCT / AB 1216
111 x 174	9512015	TM 1220	PC / PCT / AB 1220
214 x 111	9512016	TM 1224	PC / PCT / AB / PCQ3/ PCTQ3 / ABQ3 1224
141 x 174	9512017	TM 1520	PC / PCT / AB 1520
303 x 136	9512021	TM 1534	PC / PCT / AB / PCQ3/ PCTQ3 / ABQ3 1534
212 x 151	9512022	TM 1624	PC / PCT / AB / PCQ3/ PCTQ3 / ABQ3 1624
151 x 224	9512018	TM 1625	PC / PCT / AB 1625
318 x 146	9512023	TM 1636	PC / PCT / AB / PCQ3/ PCTQ3 / ABQ3 1636
318 x 186	9512024	TM 2036	PC / PCT / AB / PCQ3/ PCTQ3 / ABQ3 2036
221 x 274	9512019	TM 2330	PC / PCT / AB 2330
383 x 315	9512025	TM 3640	PC / PCT / AB 3640
64 x 69	9823000	PM 0808	P 080806
64 x 99	9823001	PM 0811	P 081106
64 x 149	9823002	PM 0816	P 081606
64 x 179	9823003	PM 0819	P 081906
107 x 110	9511150	AM 1212	P 121209
107 x 207	9511095	AM 1222	P 122209
146 x 146	9823006	PM 1616	P 161609
146 x 224	9823007	PM 1626	P 162609
146 x 346	9511175	AM 1636	P 163609
231 x 240	9823009	PM 2526	P 252612
231 x 383	9823010	PM 2540	P 254012
390 x 385	9823011	PM 4040	P 404012

DIN-rail 15 mm, short (Galvanized steel)

Dimensions	Code	Symbol	For enclosures
68 x 15	9820004	TRM 0808	PC / PCT / AB 0812
68 x 15	9820004	TRM 0808	PC / PCT / AB 0816
110 x 15	9820008	TRM 1212	PC / PCT / AB / PCQ3/ PCTQ3 / ABQ3 1224
226 x 35	9822008	TRH 24	PC / PCT / AB 1625
140 x 15	9820011	ARM 0615	PC / PCT / AB / PCQ3/ PCTQ3 / ABQ3 1636
146 x 15	9820013	TRM 0816	PC / PCT / AB 2330

DIN-rail 35 mm, short (Galvanized steel)

Dimensions	Code	Symbol	For enclosures
100 x 35	5514082	MIV 10	PC / PCT / AB 1216
100 x 35	5514082	MIV 10	PC / PCT / AB 1220
110 x 35	9822002	TRH 1212	PC / PCT / AB / PCQ3/ PCTQ3 / ABQ3 1224
122 x 35	9822021	TRH 15	PC / PCT / AB / PCQ3/ PCTQ3 / ABQ3 1534
146 x 35	9852028	TRH 1216	PC / PCT / AB 1625
140 x 35	8524032	DH-3	PC / PCT / AB / PCQ3/ PCTQ3 / ABQ3 1636
146 x 35	9852028	TRH 1216	PC / PCT / AB 2330

DIN-rail 15 mm, long (Galvanized steel)

Dimensions	Code	Symbol	For enclosures
48 x 15	9820001	TRM 0507	PC / PCT / AB 0507
68 x 15	9820004	TRM 0808	PC / PCT / AB 0808
106 x 15	9820009	TRM 0812	PC / PCT / AB 0812
146 x 15	9820013	TRM 0816	PC / PCT / AB 0816
110 x 15	9820008	TRM 1212	PC / PCT / AB 1212
146 x 15	9820013	TRM 0816	PC / PCT / AB 1216
68 x 15	9820004	TRM 0808	P 080806
99 x 15	9820006	PRM 0811	P 081106
149 x 15	9820012	PRM 0816	P 081606
179 x 15	9820015	PRM 0819	P 081906
140 x 15	9820011	ARM 0615	P 161609

DIN-rail 35 mm, long (Galvanized steel)

Dimensions	Code	Symbol	For enclosures
146 x 35	9822028	TRH 1216	PC / PCT / AB 0816
110 x 35	9822002	TRH 1212	PC / PCT / AB 1212
146 x 35	9822028	TRH 1216	PC / PCT / AB 1216
186 x 35	9822006	TRH 1220	PC / PCT / AB 1220
226 x 35	9822008	TRH 24	PC / PCT / AB / PCQ3/ PCTQ3 / ABQ3 1224
186 x 35	9822006	TRH 1220	PC / PCT / AB 1520
307 x 35	9822022	TRH 34	PC / PCT / AB / PCQ3/ PCTQ3 / ABQ3 1534
226 x 35	9822008	TRH 24	PC / PCT / AB / PCQ3/ PCTQ3 / ABQ3 1624
226 x 35	9822008	TRH 24	PC / PCT / AB 1625
340 x 35	9822023	TRH 2036	PC / PCT / AB / PCQ3/ PCTQ3 / ABQ3 1636
340 x 35	9822023	TRH 2036	PC / PCT / AB / PCQ3/ PCTQ3 / ABQ3 2036
285 x 35	9822013	TRH 2330	PC / PCT / AB 2330
380 x 35	9822024	TRH 40	PC / PCT / AB 3640
146 x 35	9852028	TRH 1216	P 081606
105 x 35	9822001	ARH 12	P 121209
203 x 35	9822007	ARH 22	P 122209
140 x 35	9822003	ARH 16	P 161609
240 x 35	9822011	ARH 26	P 162609
343 x 35	9822015	ARH 36	P 163609
238 x 35	9821007	PRH 2526	P 252612
383 x 35	9822017	ARH 40	P 254012
383 x 35	9822017	ARH 40	P 404012

Other accessories

Code	Symbol	Description
8522346	FP 22046	Wall fastening lugs (4 pcs.) incl. screws
9802001	TH A	Grey plastic hinges (2 pcs.) incl. mounting screws
7028540	MRS 28540	Wall fastening lugs (2 pcs.) incl. screws for enclosures P 0808 - P 0819
7028541	MRS 28541	Wall fastening lugs (2 pcs.) incl. screws for enclosures P 1212 - P 4040

Secure protection of terminal blocks and electronic devices.



Including:

Base with screws for mounting plate / DIN-rail, cover with PUR gasket and stainless steel cover screws.

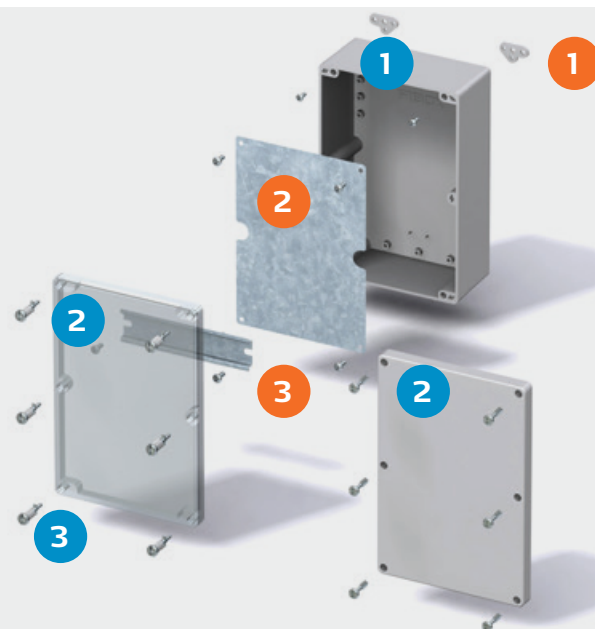

ENCLOSURE:

- 1 Base
- 2 Cover, grey or transparent
- 3 Rapidly installed QuickLock cover screws

ACCESSORIES:

- 1 Fastening lugs (4 pcs.) incl. screws
- 2 Mounting plate, electro-galvanised steel resistance to corrosion
- 3 DIN rail, different sizes TS 15 / TS 35

ALN

FOR THE PROTECTIVE LIGHTNESS OF ALUMINIUM

Our ALN enclosures can be mounted almost anywhere, so it's just as well they withstand so much! Knocks, bangs, chemicals, temperatures that swing from tropical to frozen, or where EMC protection is an issue – ALN beats the competition in guarding against it all.

ALN: IP 66/67/68; IK 08



DIMENSIONS:

60 x 66 x 46 mm – 310 x 600 x 180 mm

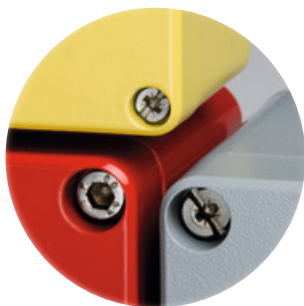

High resistance to chemical attack (painted)



EMC shielding



Higher temperature range

SIZES AND PRODUCT VERSIONS

Dimensions	Aluminium painted enclosures		Aluminium unpainted enclosures	
	Code	Symbol	Code	Symbol
66 x 60 x 46	7811060	ALN 060605	7831060	ALN 060605 UP
66 x 100 x 46	7811080	ALN 061005	7831080	ALN 061005 UP
82 x 77 x 57	7811130	ALN 080806	7831130	ALN 080806 UP
81 x 127 x 57	7811150	ALN 081306	7831150	ALN 081306 UP
81 x 177 x 57	7811170	ALN 081806	7831170	ALN 081806 UP
81 x 252 x 57	7811190	ALN 082506	7831190	ALN 082506 UP
125 x 124 x 81	7811210	ALN 121208	7831210	ALN 121208 UP
125 x 222 x 81	7811230	ALN 122208	7831230	ALN 122208 UP
120 x 360 x 82	7811250	ALN 123608	7831250	ALN 123608 UP
162 x 163 x 91	7811270	ALN 161609	7831270	ALN 161609 UP
162 x 262 x 91	7811290	ALN 162609	7831290	ALN 162609 UP
164 x 364 x 91	7811310	ALN 163609	7831310	ALN 163609 UP
234 x 204 x 111	7811350	ALN 232011	7831350	ALN 232011 UP
234 x 284 x 111	7811370	ALN 232811	7831370	ALN 232811 UP
230 x 330 x 110	7811380	ALN 233311	7831380	ALN 233311 UP
230 x 330 x 180	7811390	ALN 233318	7831390	ALN 233318 UP
230 x 410 x 180	7811410	ALN 234018	7831410	ALN 234018 UP
310 x 402 x 180	7811460	ALN 314018	7831450	ALN 314011 UP
309 x 600 x 112	7811470	ALN 316011	7831460	ALN 314018 UP
310 x 600 x 180	7811480	ALN 316018	7831480	ALN 316018 UP

Product group	Control unit/cabinet	Power distribution unit/cabinet	Power distribution board	Terminal enclosure	Junction box	Instrumentation	Electronic devices
ALN	●	–	–	●	–	●	●

ACCESSORIES

Mounting plate plain (Galvanized steel, 1,5 mm)			
Dimensions	Code	Symbol	For enclosures
69 x 64	9823015	AM 0808	ALN 080806
69 x 114	9511043	AM 0813	ALN 081306
69 x 164	9823017	AM 0818	ALN 081806
69 x 164	9823017	AM 0818	ALN 082506
107 x 110	9511150	AM 1212	ALN 121208
107 x 207	9511095	AM 1222	ALN 122208
107 x 347	9511174	AM 1236	ALN 123608
146 x 146	9511149	AM 1616	ALN 161609
146 x 244	9511096	AM 1626	ALN 162609
146 x 346	9511175	AM 1636	ALN 163609
215 x 184	9511015	AM 2320	ALN 232011
215 x 264	9511016	AM 2328	ALN 232811
215 x 315	9511017	AM 2333	ALN 233311 / 18
215 x 385	9511018	AM 2340	ALN 234018
394 x 387	9511020	AM 3140	ALN 314018
293 x 585	9511021	AM 3160	ALN 316011 / 18

Other accessories		
Code	Symbol	Description
7028540	MRS 28540	Wall fastening lugs (2 pcs.) incl. screws for enclosures ALN 0606 - ALN 0825
7028541	MRS 28541	Wall fastening lugs (2 pcs.) incl. screws for enclosures ALN 1212 - ALN 6031
9801059	AH New	Hinges (2 pcs.) incl. mounting screws
7028540	MRS 28540	Wall fastening lugs (2 pcs.) incl. screws for enclosures P 0808 - P 0819
7028541	MRS 28541	Wall fastening lugs (2 pcs.) incl. screws for enclosures P 1212 - P 4040

DIN-rail 15 mm, long (Galvanized steel)			
Dimensions	Code	Symbol	For enclosures
48 x 15	9820001	TRM 0507	ALN 060605
88 x 15	9820005	ARM 0610	ALN 061005
65 x 15	9820002	ARM 0808	ALN 080806
115 x 15	9820010	ARM 0813	ALN 081306
165 x 15	9820014	ARM 0818	ALN 081806
240 x 15	9820019	ARM 0825	ALN 082506

DIN-rail 35 mm, long (Galvanized steel)			
Dimensions	Code	Symbol	For enclosures
50 x 35	5514081	MIV 5	ALN 060605
160 x 35	3770647	EKV 12	ALN 081806
240 x 35	9822011	ARH 26	ALN 082506
105 x 35	9822001	ARH 12	ALN 121208
203 x 35	9822007	ARH 22	ALN 122208
343 x 35	9822015	ARH 36	ALN 123608
140 x 35	9822003	ARH 16	ALN 161609
240 x 35	9822011	ARH 26	ALN 162609
340 x 35	9822029	ARH 1636	ALN 163609
180 x 35	9822005	ARH 2320	ALN 232011
260 x 35	9822012	ARH 2328	ALN 232811
310 x 35	9822014	ARH 2333	ALN 233311 / 18
383 x 35	9822017	ARH 40	ALN 234018 + ALN 314018
580 x 35	9822019	ARH 60	ALN 316011 + ALN 316018

Designed to mount terminal blocks. Ideal for housing and protecting different sensor types/electr. components.

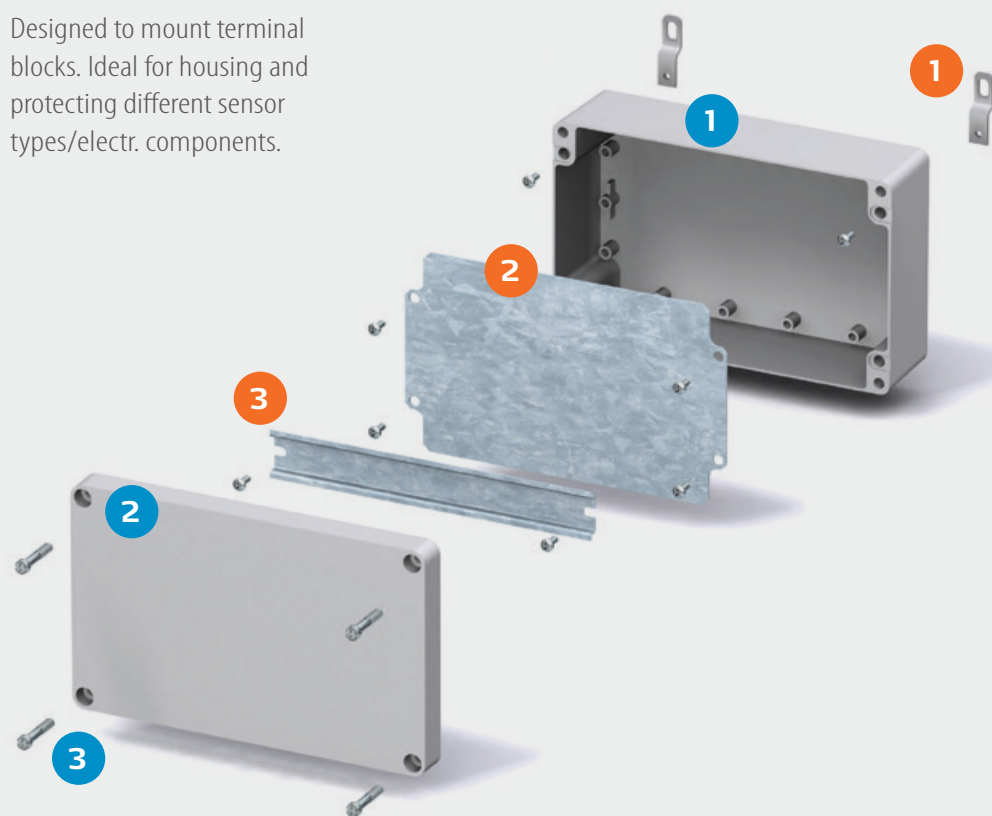

ENCLOSURE:

- 1 Base
- 2 Cover, grey
- 3 Cover screws, various versions



ACCESSORIES:

- 1 Fastening lugs (4 pcs.) incl. screws
- 2 Mounting plate, electro-galvanised steel, stable and impact-resistant
- 3 DIN rail with mounting screws different sizes TS 15 / TS 35

Including:

Base with screws for mounting plate/DIN-rail, cover with PUR gasket and stainless steel cover screws.

TEMPO

ENCLOSED IN SECONDS!

As its name suggests, Tempo doesn't like to hang around. Need an enclosure that's easy on the pocket and installed in seconds, but still gets the job done? Tempo does all this and still meets high, recognised standards.

ABS: IP 65; IK 07

PC: IP 65; IK 08



DIMENSIONS:

95 x 65 x 60 mm – 344 x 289 x 157 mm



Sealing availability
for added security



Quick-to-install integral hinge
in selected sizes



Multiple wall mounting options

SIZES AND PRODUCT VERSIONS

Dimensions	ABS grey cover		ABS metric knock-outs grey cover		PC grey cover		PC metric knock-outs grey cover		PC transparent cover		PC metric knock-outs transparent cover	
	Code	Symbol	Code	Symbol	Code	Symbol	Code	Symbol	Code	Symbol	Code	Symbol
95 x 65 x 60	5814038	TA 090706	5814020	TAM 090706	5824038	TPC 090706	5824020	TPCM 090706				
110 x 110 x 65	5814039	TA 111107	5814021	TAM 111107	5824039	TPC 111107	5824021	TPCM 111107				
130 x 95 x 65	5814040	TA 131007	5814022	TAM 131007	5824040	TPC 131007	5824022	TPCM 131007				
130 x 130 x 75	5814041	TA 131308	5814023	TAM 131308	5824041	TPC 131308	5824023	TPCM 131308				
187 x 122 x 90	5814000	TA 191209	5814024	TAM 191209	5824000	TPC 191209	5824024	TPCM 191209	5824005	TPC 191209T	5824029	TPCM 191209T
187 x 122 x 130	5814050	TA 191213	5814062	TAM 191213								
201 x 163 x 98	5814001	TA 201610	5814025	TAM 201610	5824001	TPC 201610	5824025	TPCM 201610	5824006	TPC 201610T	5824030	TPCM 201610T
201 x 163 x 138	5814051	TA 201614	5814064	TAM 201614								
240 x 191 x 107	5814002	TA 241911			5824002	TPC 241911			5824007	TPC 241911T		
240 x 191 x 147	5814052	TA 241915										
289 x 239 x 107	5814003	TA 292411			5824003	TPC 292411			5824008	TPC 292411T		
289 x 239 x 147	5814053	TA 292415										
344 x 289 x 117	5814004	TA 342912			5824004	TPC 342912			5824009	TPC 342912T		
344 x 289 x 157	5814054	TA 342916										

Product group	Control unit/cabinet	Power distribution unit/cabinet	Power distribution board	Terminal enclosure	Junction box	Instrumentation	Electronic devices
TEMPO	–	–	–	●	●	–	–

ACCESSORIES

Mounting plates (Galvanized steel, 1.5 mm)

Dimensions	Code	Symbol	For enclosures
140 x 100	5518022	MP 1912	Tempo 1912
155 x 140	5518023	MP 2016	Tempo 2016
210 x 160	5518024	MP 2419	Tempo 2419
265 x 215	5518025	MP 2924	Tempo 2924
315 x 265	5518026	MP 3429	Tempo 3429

DIN rail-35, long

Dimensions	Code	Symbol	For enclosures
35 x 140	8524032	DH-3	Tempo 1912
35 x 180	9822005	ARH 2320	Tempo 2016
35 x 210	5518027	DR 210	Tempo 2419
35 x 265	5518028	DR 265	Tempo 2924
35 x 316	5518030	DR 316	Tempo 3429

DIN rail-35, short

Dimensions	Code	Symbol	For enclosures
35 x 100	5514082	MIV 10	Tempo 1313
35 x 140	8524032	DH-3	Tempo 2016
35 x 160	3770647	EKV 12	Tempo 2419
35 x 215	5518029	DR 215	Tempo 2924
35 x 260	9822012	ARH 2328	Tempo 3429

Hinges and wall mounting

Code	Symbol	Description
5510021	TH T	Hinge set (2 pcs.)
5510674	FP 10674	Wall fastening lug (2 pcs.) incl. screws

Quickly assembled with rapid hinge, compatible with all standard PVC enclosures.

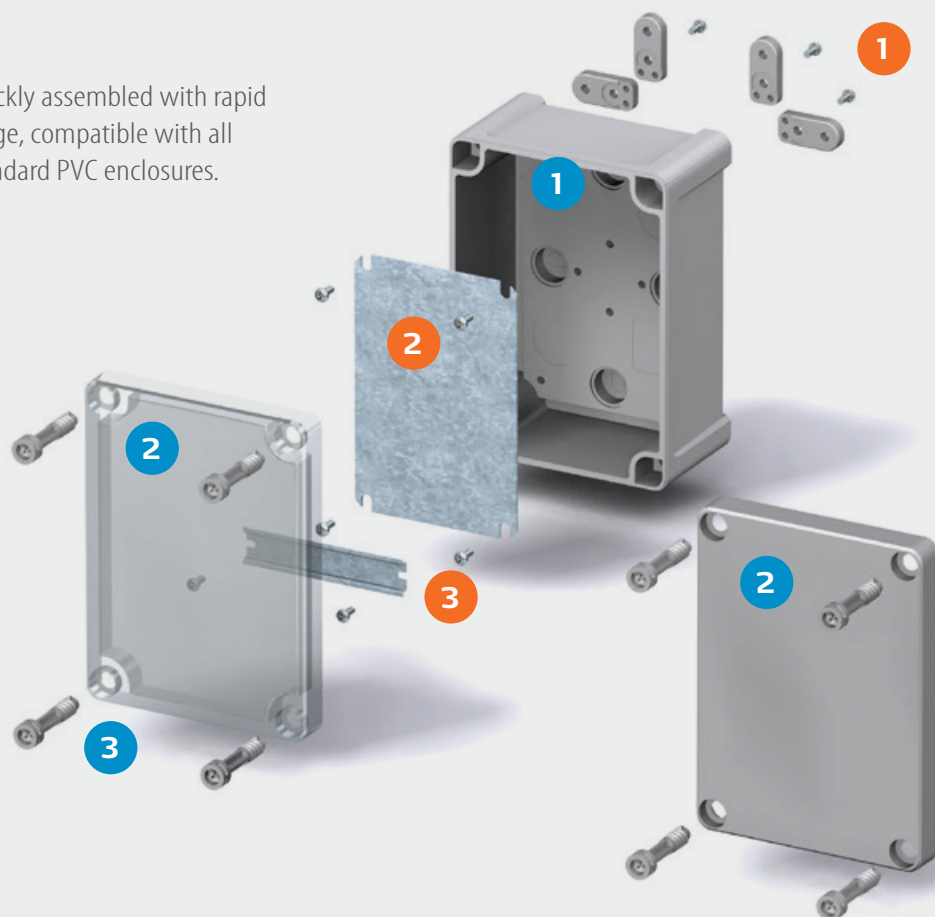

ENCLOSURE:

- 1 Base
- 2 Cover, grey or transparent
- 3 Cover screws, holding hinge, transparent



ACCESSORIES:

- 1 Fastening lugs (set)
- 2 Mounting plate, steel, galvanised
- 3 DIN rail TS 15 / TS 35

Including:

Base with PUR gasket, screws for mounting plate/DIN-rail and cover with polyamide cover screws.

PICCOLO

PROTECTIVE ACCESS

Wherever functions, such as push buttons and sensors, need to see the light of day, Piccolo is the neat solution. It's also modular and adaptable, with a range of sizes and accessories.

PC: IP 66/67; IK 08

ABS: IP 66/67; IK 07



DIMENSIONS:

110 x 80 x 65 mm – 230 x 140 x 125 mm



High-quality surface
for printing



Designed
for push-buttons



Optimised design
for terminal blocks

SIZES AND PRODUCT VERSIONS

Dimensions	Polycarbonate grey cover		Polycarbonate transparent cover		ABS grey hinged cover	
	Code	Symbol	Code	Symbol	Code	Symbol
110 x 80 x 65	8724303	PC B 65 G	8724003	PC B 65 T	8784303	ABS B 65 G
110 x 80 x 85	8724304	PC B 85 G	8724004	PC B 85 T	8784304	ABS B 85 G
140 x 80 x 65	8724305	PCC 65 G	8724005	PCC 65 T	8784305	ABS C 65 G
140 x 80 x 85	8724306	PCC 85 G	8724006	PCC 85 T	8784306	ABS C 85 G
170 x 80 x 65	8724307	PC D 65 G	8724007	PC D 65 T	8784307	ABS D 65 G
170 x 80 x 85	8724308	PC D 85 G	8724008	PC D 85 T	8784308	ABS D 85 G
230 x 80 x 65	8724311	PC F 65 G	8724011	PC F 65 T	8784311	ABS F 65 G
230 x 80 x 85	8724312	PC F 85 G	8724012	PC F 85 T	8784312	ABS F 85 G
170 x 140 x 95	8724315	PCH 95 G	8724015	PCH 95 T	8784315	ABS H 95 G
230 x 140 x 95	8724318	PCM 95 G	8724018	PCM 95 T	8784318	ABS M 95 G
230 x 140 x 125	8724319	PCMH 125 G	8724019	PCMH 125 T	8784319	ABS MH 125 G

Product group	Control unit/cabinet	Power distribution unit/cabinet	Power distribution board	Terminal enclosure	Junction box	Instrumentation	Electronic devices
PICCOLO	●	–	–	●	–	●	–

ACCESSORIES

Mounting plate plain (Galvanized steel, 1,5 mm)

Dimensions	Code	Symbol	For enclosures
80 x 54	8524060	B-MP	PC/ABS B
110 x 54	8524061	C-MP	PC/ABS C
140 x 54	8524062	D-MP	PC/ABS D
200 x 54	8524063	F-MP	PC/ABS F
125 x 94	8524064	H-MP	PC/ABS H
185 x 94	8524065	M-MP	PC/ABS M/MH

Other accessories

Code	Symbol	Description
8522346	FP 22046	Wall fastening lugs (4 pcs.) incl. screws
9802001	TH A	Grey plastic hinges (2 pcs.) incl. mounting screws

DIN-rail 15 mm, long (Galvanized steel)

Dimensions	Code	Symbol	For enclosures
80 x 35	8524030	B-3	PC/ABS B
110 x 35	8524031	CHM-3	PC/ABS C
140 x 35	8524032	DH-3	PC/ABS D
200 x 35	8524033	FM-3	PC/ABS F
140 x 35	8524032	DH-3	PC/ABS H
200 x 35	8524033	FM-3	PC/ABS M/MH

DIN-rail 35 mm, short (Galvanized steel)

Dimensions	Code	Symbol	For enclosures
110 x 35	8524031	CHM-3	PC/ABS H
110 x 35	8524031	CHM-3	PC/ABS M/MH

Secure protection for electronic devices such as push buttons, terminal blocks. Optimum protection for control sensors and interruptors

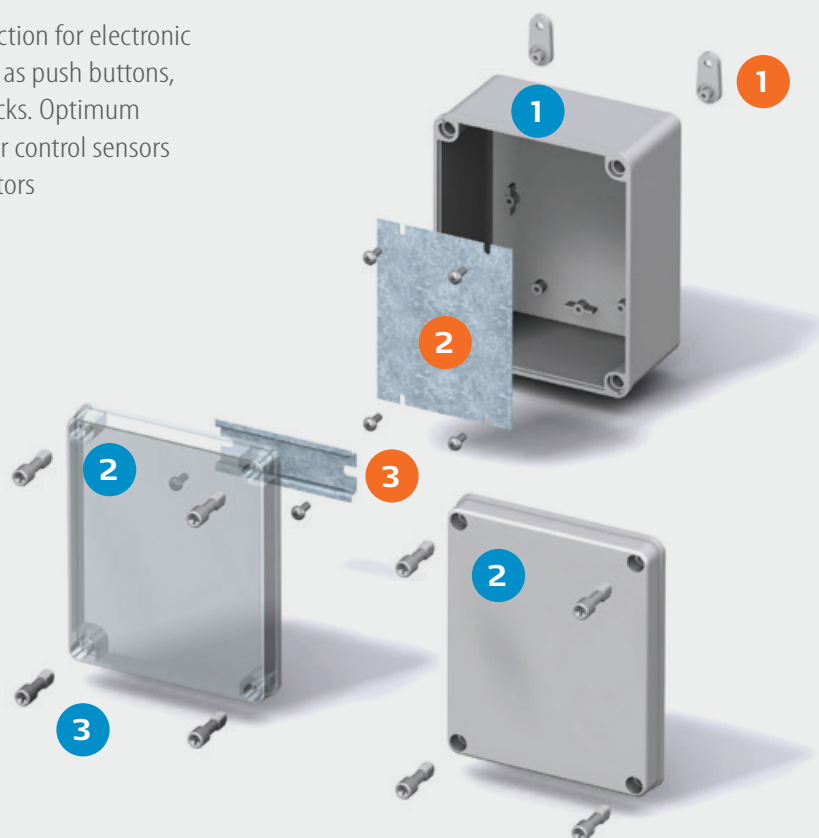

ENCLOSURE:

- 1 Base
- 2 Cover, grey or transparent
- 3 Cover screws, various versions

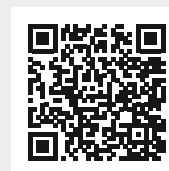

ACCESSORIES:

- 1 Fastening lugs (2 pcs.) incl. screws
- 2 Mounting plate, electro-galvanized steel stable and impact-resistant
- 3 DIN rail different sizes TS 35

Including:

Flanged Base with screws for mounting plate, cover with PUR gasket and polyamide cover screws.

QUICK

FOR HARSH INDUSTRIAL AND OUTDOOR ENVIRONMENTS

These smart, modern enclosures are so-named after their quick-screw covers. They're easy to close and open, but offer good protection against tampering. A large range of accessories is available.

PC: IP 66/67; IK 08

ABS: IP 66/67; IK 08

DIMENSIONS:

300 x 200 x 170 mm – 600 x 400 x 270 mm



Quick locking cover screws for fast access to components

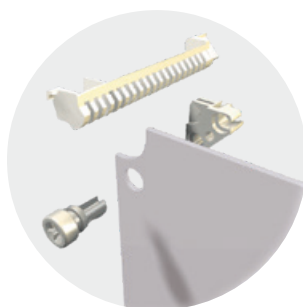

Adjustable depth for front panel

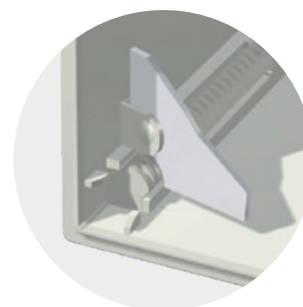

Swing door

SIZES AND PRODUCT VERSIONS

Dimensions	Polycarbonate grey cover		Polycarbonate transparent cover		ABS grey cover	
	Code	Symbol	Code	Symbol	Code	Symbol
300 x 200 x 170	8113338	CAB PCQ 302017 G	8113038	CAB PCQ 302017 T	8183338	CAB ABSQ 302017 G
300 x 300 x 170	8113348	CAB PCQ 303017 G	8113048	CAB PCQ 303017 T	8183348	CAB ABSQ 303017 G
400 x 300 x 170	8113358	CAB PCQ 403017 G	8113058	CAB PCQ 403017 T	8183358	CAB ABSQ 403017 G
400 x 300 x 230	8113458	CAB PCQ 403023 G	8113158	CAB PCQ 403023 T		
400 x 400 x 170	8113488	CAB PCQ 404017 G	8113088	CAB PCQ 404017 T		
600 x 300 x 170	8113468	CAB PCQ 603017 G	8113068	CAB PCQ 603017 T		
600 x 400 x 210	8113378	CAB PCQ 604021 G	8113078	CAB PCQ 604021 T		
600 x 400 x 270	8113478	CAB PCQ 604027 G	8113178	CAB PCQ 604027 T		

Product group	Control unit/cabinet	Power distribution unit/cabinet	Power distribution board	Terminal enclosure	Junction box	Instrumentation	Electronic devices
QUICK	●	●	—	—	—	—	—

ACCESSORIES

Mounting plate plain (Galvanized steel, 1,5 mm)			
Dimensions	Code	Symbol	For enclosures
270 x 170	4712117	EKIV 23	PCQ / ABSQ 3020
270 x 270	4712118	EKIV 33	PCQ / ABSQ 3030
370 x 270	4712119	EKIV 43	PCQ / ABSQ 4030
370 x 370	4712289	EKIV 44	PCQ / ABSQ 4040
570 x 270	4712120	EKIV 63	PCQ / ABSQ 6030
570 x 370	4712300	EKIV 64	PCQ / ABSQ 6040

Other accessories		
Code	Symbol	Description
4712045	FP 12017	Wall fastening lugs (4 pcs.) incl. screws
4512040	PAT 12040	Grey plastic hinges (2 pcs.) incl. mounting screws

DIN-rail 35 mm, long (Galvanized steel)			
Dimensions	Code	Symbol	For enclosures
266 x 35	4712127	EKIV 27	PCQ / ABSQ 3020
266 x 35	4712127	EKIV 27	PCQ / ABSQ 3030
366 x 35	4712128	EKIV 37	PCQ / ABSQ 4030
366 x 35	4712128	EKIV 37	PCQ / ABSQ 4040

DIN-rail 35 mm, short (Galvanized steel)			
Dimensions	Code	Symbol	For enclosures
166 x 35	4712126	EKIV 17	PCQ / ABSQ 3020
266 x 35	4712127	EKIV 27	PCQ / ABSQ 4030
266 x 35	4712127	EKIV 27	PCQ / ABSQ 6030
366 x 35	4712128	EKIV 37	PCQ / ABSQ 6040

Highly impact-resistant polycarbonate, suitable for rough industrial environments. Practical version with quick screw cover.

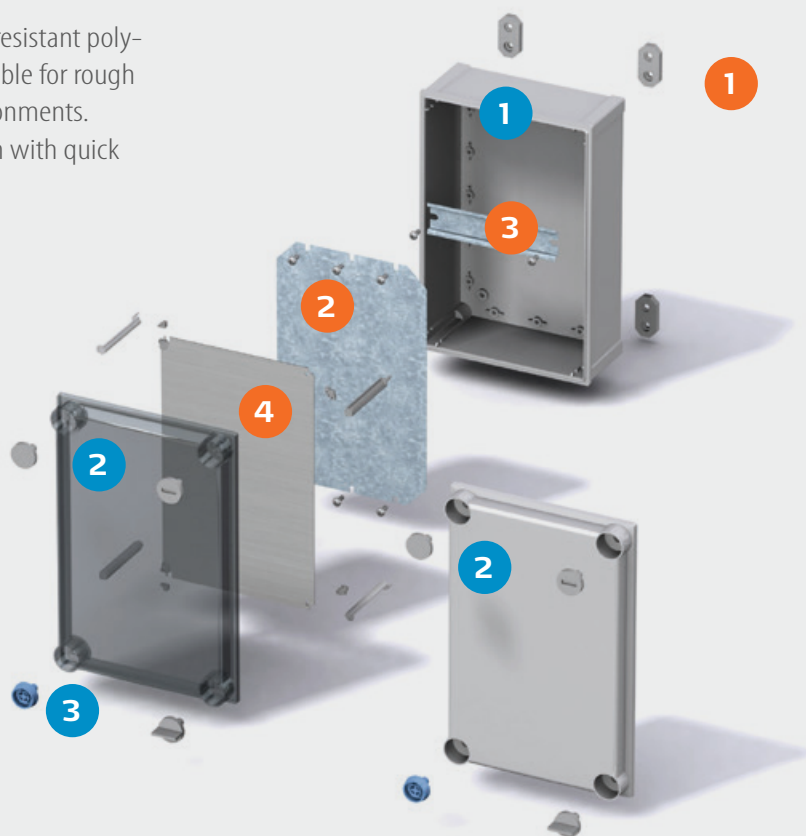

ENCLOSURE:

- 1 Base
- 2 Cover, grey or transparent
- 3 Cover screws, various versions



ACCESSORIES:

- 1 Mounting set with cover screw attachments
- 2 Mounting plate, electro-galvanized steel, stable and impact-resistant
- 3 DIN rail different sizes TS 35
- 4 Pivotable front plate, aluminium

Including:

Base with screws for mounting plate/DIN-rail, internal corner plugs, cover with PUR gasket and CS 12137 cover screws.

CARDMASTER

TWO COMPARTMENTS IN ONE

CARDMASTER is a modern, new design that keeps untidy wiring separate from the equipment you need to use, say, for process monitoring. This neat solution is completely compatible with competitors ranges.

PC: IP 65; IK 07 (side surface); IK 08 (front surface)

ABS: IP 65; IK 07

DIMENSIONS:

166 x 160 x 80 mm – 390 x 316 x 167 mm

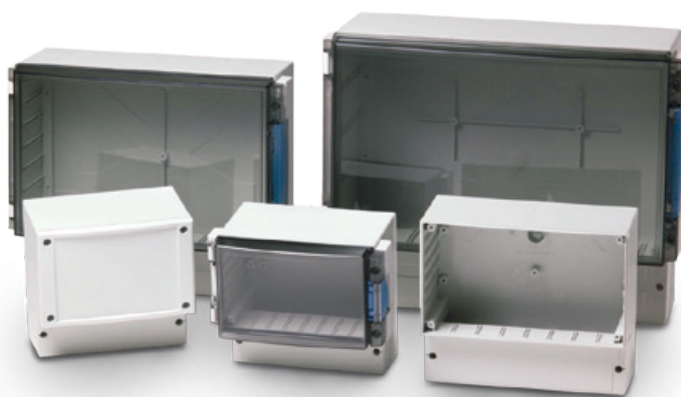

Easy access



Aluminium front plate



Separate terminal wiring compartment

SIZES AND PRODUCT VERSIONS

Dimensions	Polycarbonate enclosures		ABS enclosures		Description
	Code	Symbol	Code	Symbol	
166 x 160 x 80	7520104	PC 17/16-LC3			Enclosure without cover
188 x 160 x 106	7525105	PC 17/16-L3	7585105	ABS 17/16-L3	Enclosure with transparent smoked window
166 x 160 x 89	7520204	PC 17/16-LFC3			Enclosure with plastic front plate
166 x 160 x 108	7520080	PC 17/16-C3			Enclosure without cover
188 x 160 x 134	7525165	PC 17/16-3	7585165	ABS 17/16-3	Enclosure with transparent smoked window
166 x 160 x 118	7520280	PC 17/16-FC3			Enclosure with plastic front plate
213 x 185 x 90	7520081	PC 21/18-C3			Enclosure without cover
235 x 185 x 119	7525154	PC 21/18-3	7585154	ABS 21/18-3	Enclosure with transparent smoked window
213 x 185 x 102	7520281	PC 21/18-FC3			Enclosure with plastic front plate
257 x 219 x 122	7520141	PC 25/22-C3			Enclosure without cover
280 x 219 x 156	7525134	PC 25/22-3	7585134	ABS 25/22-3	Enclosure with transparent smoked window
257 x 219 x 135	7520241	PC 25/22-FC3			Enclosure with plastic front plate
314 x 260 x 95	7520031	PC 30/25-C3			Enclosure without cover
320 x 260 x 129	7525019	PC 30/25-3	7585019	ABS 30/25-3	Enclosure with transparent smoked window
314 x 260 x 110	7520231	PC 30/25-FC3			Enclosure with plastic front plate
383 x 316 x 134	7520032	PC 36/31-C3			Enclosure without cover
390 x 316 x 167	7525020	PC 36/31-3	7585020	ABS 36/31-3	Enclosure with transparent smoked window

Product group	Control unit/cabinet	Power distribution unit/cabinet	Power distribution board	Terminal enclosure	Junction box	Instrumentation	Electronic devices
CARDMASTER	—	—	—	—	—	●	●

ACCESSORIES

Mounting plate plain (Galvanized steel, 1,5 mm)

Dimensions	Code	Symbol	For enclosures
136 x 133	7720071	MP 17/16	PC / ABS 17/16
142 x 200	7720035	MP 21/18	PC / ABS 21/18
225 x 175	7720140	MP 25/22	PC / ABS 25/22
282 x 215	7720033	MP 30/25	PC / ABS 30/25
345 x 258	7720036	MP 36/31	PC / ABS 36/31

Front plate (Aluminium, 1,5 mm)

Dimensions	Code	Symbol	For enclosures
158 x 98	7720070	FP 17/16	PC / ABS 17/16
205 x 117	7720026	FP 21/18	PC / ABS 21/18
250 x 150	7720139	FP 25/22	PC / ABS 25/22
289 x 189	7720027	FP 30/25	PC / ABS 30/25
354 x 224	7720028	FP 36/31	PC / ABS 36/31

Other accessories

Code	Symbol	Description
5510674	FP 10674	Wall fastening lugs (2 pcs.) incl. screws

Front plate with frame (Polycarbonate)

Dimensions	Code	Symbol	For enclosures
166 x 106 x 16	7720102	FC PC 17/16	PC / ABS 17/16
213 x 125 x 20	7720100	FC PC 21/18	PC / ABS 21/18
257 x 157 x 30	7720111	FC PC 25/22	PC / ABS 25/22
294 x 196 x 30	77201112	FC PC 30/25	PC / ABS 30/25

Everything under control in the field of measurement and control technology. NEMA 4X compliant.

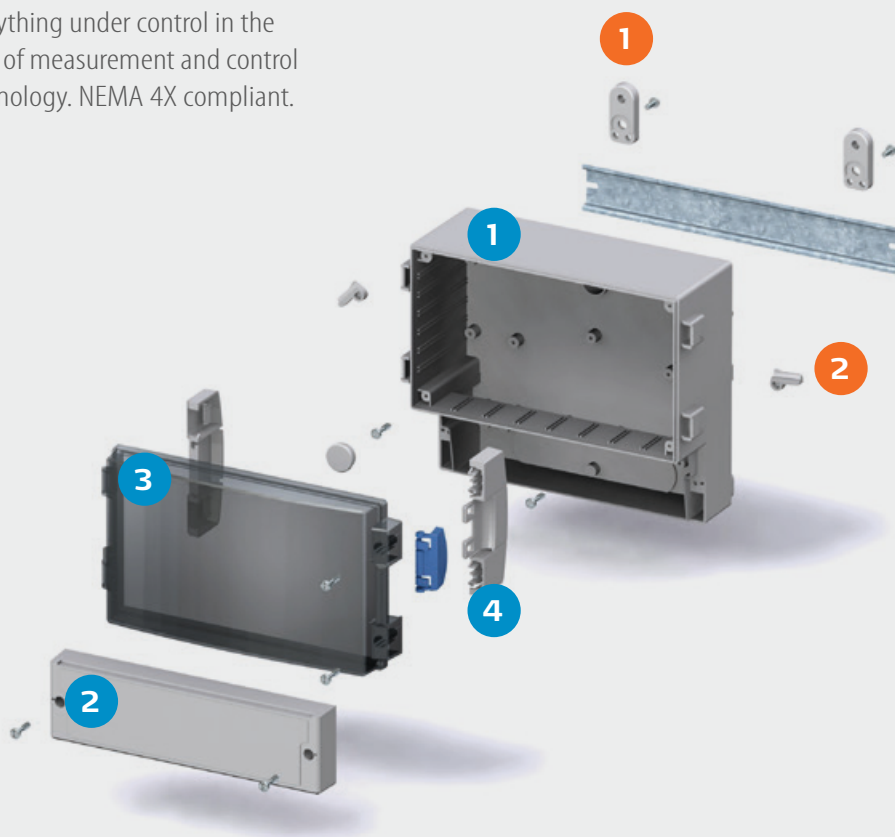

Including:

Enclosures include: Base, terminal compartment cover with PUR gasket and screws for mounting plate/DIN-rail. -3 and -L3 versions: Transparent cover with PUR gasket, hinges, locking devices; FC version: Closed PC frame front plate with PUR gasket and cover screws.

ENCLOSURE:

- 1 Basic enclosure optionally available with or without knockouts
- 2 PC front plate frame or transparent hinged cover options are standard. PUR gasket and assembly screws are included. Separate connection compartment
- 3 Polycarbonate and ABS enclosure body available
- 4 Facility to install tamper proof locking screws in the hinged cover

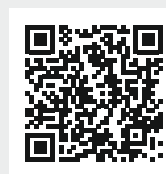

ACCESSORIES:

- 1 Fastening lugs (2 pcs.) incl. screws hinge and lock set
- 2 Internal mounting options and external din-rail mounting facility are included



SNAP ON INSTALLATION

Fibox JB electrical junction boxes are designed for indoor and outdoor use. Enclosures are maintenance free and corrosion resistant. Aesthetic design maximizing installation space – easy installation. Membrane entries allow flexible cable entry options.

PP: IP 65; IK 04

DIMENSIONS:

90 x 90 x 49, 110 x 110 x 49 mm



Including:

Including: Snap-on cover, base with TPE gasket.

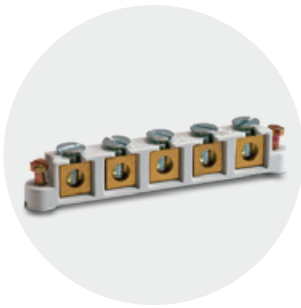

ITS 6



IES



ICS

SIZES AND PRODUCT VERSIONS

Including: Snap-on cover, base with TPE gasket

Dimensions	Code	Symbol	Description
90 x 90 x 49	8600670	JB 2.5 G	Junction box 2.5 mm ² (PP), integrated membranes
90 x 90 x 49	8600671	JB 2.5 WH	Junction box 2.5 mm ² (PP, white), integrated membranes
110 x 110 x 49	8600672	JB 6 G	Junction box 6 mm ² (PP), integrated membranes
110 x 110 x 49	8600673	JB 6 WH	Junction box 6 mm ² (PP, white), integrated membranes

ACCESSORIES

Different accessories

Code	Symbol	Description
ITS 6	8600650	Terminal strip up to 6 mm ² , 500 V hole-type, 5-terminal strip, possible connections per terminal: 6 x 1.5 mm ² 3 x 4 mm ² , 4 x 2.5 mm ² 2 x 6 mm ²
IES	8600346	Tube entry socket for JB 6 (M20 grey) for tube ø16 mm, for tube ø20 mm
ICS	8600652	Cover fastening screws for JB 6 (Stainless steel)
GPA M20	7016402	Cable gland (IP 68 - 5 bar), M20x1,5, for cable 8-13 mm



Product group	Control unit/cabinet	Power distribution unit/cabinet	Power distribution board	Terminal enclosure	Junction box	Instrumentation	Electronic devices
JB	—	—	—	—	●	—	—

STRC

PROTECTION ON THE STREETS

This streetwise range is designed to foil both the elements and street vandalism. Inside the multi-environment cabinet, your equipment will be shielded by a graffiti-repellent casing that also resists impacts and penetration. Street Cabinet is easy and quick to install, with numerous sizes and accessories.



P: IP 44; IK 10

DIMENSIONS:

420 x 265 x 250 mm – 1125 x 1445 x 320 mm



Several locking options



Integrated ventilation to avoid condensation



Corrugated surface

SIZES AND PRODUCT VERSIONS

Streetcabinet, Polyester, with pedestal		
Dimensions	Code	Symbol
1695 x 265 x 250	6801022	STCP 2684
1435 x 400 x 250	6801024	STCP 4058
1695 x 400 x 250	6801025	STCP 4084
1730 x 400 x 320	6801026	STCP 4084/32
1695 x 530 x 250	6801029	STCP 5384
1695 x 530 x 320	6801030	STCP 5384/32

Streetcabinet, Polyester, DIN norm, pedestal separately		
Dimensions	Code	Symbol
1125 x 455 x 320	8843767	STC 455 - 1125
1125 x 590 x 320	8843180	STC 590 - 1125
1125 x 785 x 320	8843181	STC 785 - 1125
1125 x 1115 x 320	8843182	STC 1115 - 1125
1125 x 1425 x 320	8843183	STC 1445 - 1125

ACCESSORIES

Mounting plate (Insulated)		
Dimensions	Code	Symbol
230 x 780 x 10	6803232	MPF 2684
370 x 520 x 10	6803234	MPF 4058
370 x 780 x 10	6803235	MPF 4084
500 x 780 x 10	6803239	MPF 5384
915 x 350 x 5	8843682	MPP 445-1125
915 x 485 x 5	8843070	MPP 590-1125
915 x 680 x 5	8843071	MPP 785-1125
915 x 1000 x 5	8843072	MPP 1115-1125
915 x 1340 x 5	8843256	MPP 1445-1125

Mounting plate (Galvanized steel)		
Dimensions	Code	Symbol
230 x 780 x 2	MPS 2684	6803132
370 x 520 x 2	MPS 4058	6803134
370 x 780 x 2	MPS 4084	6803135
500 x 780 x 2	MPS 5384	6803139

Pedestal		
Dimensions	Code	Symbol
900 x 450 x 310	8843204	STP 445
900 x 585 x 310	8843205	STP 590
900 x 780 x 310	8843206	STP 785
900 x 1100 x 310	8843207	STP 1115
900 x 1430 x 310	8843208	STP 1445

Product group	Control unit/cabinet	Power distribution unit/cabinet	Power distribution board	Terminal enclosure	Junction box	Instrumentation	Electronic devices
STRC	●	●	—	—	—	—	—

CABLE MANAGEMENT

Fibox offers a huge range of accessories for connecting cables to equipment. These cable solutions meet internationally recognised safety and protection standards.



METRIC FLANGE PLATES

Cable gland plates, Polycarbonate (PC), IP 65 (EN 60529), grey RAL 7035, Flame resistance UL 94-V1

Dimensions	Code	Symbol	Description
140 x 49 x 10	3530537	MB 10537	Size 1 • 1xM40
216 x 85 x 10	3590860	MB 10860 SET	Size 2 • 5xM25+6xM20 incl. flange, gasket and connector set
216 x 85 x 10	3590861	MB 10861 SET	Size 2 • 2xM50+4xM20 incl. flange, gasket and connector set
216 x 85 x 10	3590862	MB 10862 SET	Size 2 • 2xM16+3xM20+2xM25+2xM32 incl. flange, gasket and connector set
216 x 85 x 10	3590891	MB 10891 SET	Size 2 • 12xM20 incl. flange, gasket and connector set
140 x 49 x 10	3590892	MB 10892 SET	Size 1 • 4xM20 incl. flange, gasket and connector set

Knock-out plates, Polycarbonate (PC), IP 65 (EN 60529), grey RAL 7035, Flame resistance UL 94-V1

Dimensions	Code	Symbol	Description
216 x 85 x 10	3590857	MB 10857 SET	Size 2 • 4xM12+4xM12/M20+4xM16/M25 incl. flange, gasket and connector set
216 x 85 x 10	3590889	MB 10889 SET	Size 2 • 8xM20+5xM25/M16 incl. flange, gasket and connector set
216 x 85 x 10	3590890	MB 10890 SET	Size 2 • 2xM32/M20+2xM40/M25 incl. flange, gasket and connector set

MEMBRANE FLANGE PLATES

TPE (Thermo Plastic Elastomer), IP 65 (EN 60529), Flame resistance UL 94HB, grey RAL 7035, Temperature range -40°...+120°C, Set includes: Flange and MB 10670/10671 plate connectors with screws

Dimension	Code	Symbol	Description
140 x 49	3590794	FMB 5F-SET	Size 1 • Lead-through 8 (ø 2.5-25 mm), optional RJ-45 lead-through
217 x 85	3590795	FMC 3F-SET	Size 2 • Lead-through 7 (ø 3-55 mm)
217 x 85	3590796	FMC 25F-SET	Size 2 • Lead-through 29 (ø 3-26 mm), optional RJ-45 lead-through
217 x 85	3590797	FMC 35F-SET	Size 2 • Lead-through 43 (ø 3-30 mm), optional RJ-45 lead-through

PLATE CONNECTORS AND GASKETS

Plate connector sets

Code	Symbol	Description
3570671	MB 10671	Size 1 • Connector set incl. 4 screws
3570670	MB 10670	Size 2 • Connector set incl. 4 screws
3570672	MB 10672	Size 3 • Connector set incl. 4 screws

Gaskets (EPDM Rubber)

Code	Symbol	Description
3510437	MK 10437	Size 1 • Flange gasket
3510438	MK 10438	Size 2 • Flange gasket
3510439	MK 10439	Size 3 • Flange gasket

CABLE ENTRIES AND BOXES

Cable entries		
Code	Symbol	Description
3550387	EPA 2160	Cable entry (size 2), 1 cable, 1 x 28-60 mm
3550388	EPA 2260	Cable entry (size 2), 2 cables, 2 x 28-60 mm
3550056	EPA 2160 SET	Cable entry set
3550052	EPA 2260 SET	Cable entry set

Cable entry boxes			
Dimensions	Code	Symbol	Description
	3730260	MB 2260	Including: base, cover, cover screws, 1 blind plug, 1 pull-off
	3730261	MB 2260A	Cable entry accessory set
280 x 280 x 100	3530700	EPA-OE	Cable entry box
380 x 280 x 150	3530702	EPA-PL	Cable entry box

POLYAMIDE CABLE GLANDS

Standard connecting threads, grey RAL 7035, temperature range -20°...+100°C			
Code	Symbol	Description	For cable
7016400	GPA M12	Cable gland (IP 68 - 5 bar), M12x1,5	3-6 mm
7016401	GPA M16	Cable gland (IP 68 - 5 bar), M16x1,5	5-10 mm
7016402	GPA M20	Cable gland (IP 68 - 5 bar), M20x1,5	8-13 mm
7016403	GPA M25	Cable gland (IP 68 - 5 bar), M25x1,5	11-17 mm
7016404	GPA M32	Cable gland (IP 68 - 5 bar), M32x1,5	15-21 mm
7016405	GPA M40	Cable gland (IP 68 - 5 bar), M40x1,5	19-28 mm
7016406	GPA M50	Cable gland (IP 68 - 5 bar), M50x1,5	27-35 mm
7016407	GPA M63	Cable gland (IP 68 - 5 bar), M63x1,5	32-42 mm

Long connecting threads, grey RAL 7035, Temperature range -20°...+100°C			
Code	Symbol	Description	For cable
7016533	GPA M12-L	Cable gland (IP 68 - 5 bar), M12x1,5	3-6 mm
7016534	GPA M16-L	Cable gland (IP 68 - 5 bar), M16x1,5	5-10 mm
7016535	GPA M20-L	Cable gland (IP 68 - 5 bar), M20x1,5	8-13 mm
7016536	GPA M25-L	Cable gland (IP 68 - 5 bar), M25x1,5	11-17 mm
7016537	GPA M32-L	Cable gland (IP 68 - 5 bar), M32x1,5	15-21 mm
7016538	GPA M40-L	Cable gland (IP 68 - 5 bar), M40x1,5	19-28 mm
7016539	GPA M50-L	Cable gland (IP 68 - 5 bar), M50x1,5	27-35 mm
7016540	GPA M63-L	Cable gland (IP 68 - 5 bar), M63x1,5	32-42 mm

Lock nuts for cable glands, grey RAL 7035		
Code	Symbol	Description
7016408	GPA M12-B	Hexagonal lock nut, M12x1,5
7016409	GPA M16-B	Hexagonal lock nut, M16x1,5
7016410	GPA M20-B	Hexagonal lock nut, M20x1,5
7016411	GPA M25-B	Hexagonal lock nut, M25x1,5
7016412	GPA M32-B	Hexagonal lock nut, M32x1,5
7016413	GPA M40-B	Hexagonal lock nut, M40 x 1,5
7016414	GPA M50-B	Hexagonal lock nut, M50 x 1,5
7016415	GPA M63-B	Hexagonal lock nut, M63x1,5

MEMBRANE CABLE GLANDS

EPDM Rubber, grey RAL 7035, IP 67 (EN 60529), Wall thickness 1-5 mm, Temperature range -40°...+110°C			
Code	Symbol	Description	For cable
3545078	FEM 4-7	EPDM Cable gland M12	4-7 mm
3545079	FEM 5-9	EPDM Cable gland M16	5-9 mm
3545278	FEM 4-7 L	EPDM Cable gland M12	4-7 mm
3545279	FEM 5-9 L	EPDM Cable gland M16	5-9 mm
3545080	FEM 8-13	EPDM Cable gland M20	8-13 mm
3545081	FEM 10-14/PG 16	EPDM Cable gland PG16	10-14 mm
3545082	FEM 11-17	EPDM Cable gland M25	11-17 mm
3545083	FEM 15-20	EPDM Cable gland M32	15-20 mm
3545084	FEM 19-28	EPDM Cable gland M40	19-28 mm
3545085	FEM 27-35	EPDM Cable gland M50	27-35 mm
3545103	FEM 34-45	EPDM Cable gland M63	34-45 mm
3546151	MFM 8-12	EPDM Multi-Fem M50	3x6-10 mm, 3x10-14 mm

CR, RAL 9005, IP 67 (EN 60529), Wall thickness 1-5 mm, Temperature range -30°...+100°C			
Code	Symbol	Description	For cable
3545088	FEM-C 4-7	Chloroprene Cable gland M12	4-7 mm
3545089	FEM-C 5-9	Chloroprene Cable gland M16	5-9 mm
3545288	FEM-C 4-7 L	Chloroprene Cable gland M12	4-7 mm
3545289	FEM-C 5-9 L	Chloroprene Cable gland M16	5-9 mm
3545090	FEM-C 8-13	Chloroprene Cable gland M20	8-13 mm
3545091	FEM-C 10-14/PG 16	Chloroprene Cable gland PG16	10-14 mm
3545092	FEM-C 11-17	Chloroprene Cable gland M25	11-17 mm
3545093	FEM-C 15-20	Chloroprene Cable gland M32	15-20 mm
3545094	FEM-C 19-28	Chloroprene Cable gland M40	19-28 mm
3545095	FEM-C 27-35	Chloroprene Cable gland M50	27-35 mm
3545104	FEM-C 34-45	Chloroprene Cable gland M63	34-45 mm

COVER PLATES

Polycarbonate (PC), IP 66 (EN 60529), grey RAL 7035, Flame resistance UL 94-V1			
Dimensions	Code	Symbol	Description
216 x 85 x 10	3530546	MB 10546	Size 2 - Cover plate
332 x 127 x 15	3530324	MB 10324	Size 3 - Cover plate



GENERAL ACCESSORIES

Even the best enclosure may need a little extra, to be of maximum value in its chosen environment. Among many other benefits, our huge range of accessories will allow your components to be seen, ventilated or withstand pressure differences.

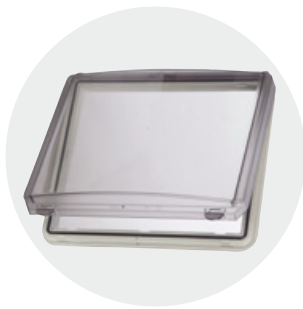

Inspection windows



Ventilation devices



Fibox accessories can be fitted to most enclosures and cabinets

INSPECTION WINDOWS

Polycarbonate (PC), IP 54			
Dimension	Code	Symbol	Description
60 x 77	3730660	L 02	Window for 2 modules (clear cover)
96 x 77	3730661	L 04	Window for 4 modules (clear cover)
130 x 77	3730662	L 06	Window for 6 modules (clear cover)
162 x 77	3730663	L 08	Window for 8 modules (clear cover)
199 x 77	3730664	L 10	Window for 10 modules (clear cover)

Front plates for windows L 12 II and L 24 II		
Symbol	Code	Description
3730621	B12 10621-45	Front plate for window 12 modules
3730620	B24 10620-45	Front plate for window 2x12 modules

Polycarbonate (PC), IP 65			
Dimension	Code	Symbol	Description
248 x 128	3730775	L 12 II	Window for 12 modules (smoked transparent cover)
257 x 108	3730692	L 13	Window for 13 modules (clear cover)
248 x 218	3730776	L 24 II	Window for 24 modules (smoked transparent cover)
331 x 277	4512298	L 43 II	Window for 26 modules (smoked transparent cover)
377 x 331	4512299	L 44 II	Window for 36 modules (smoked transparent cover)

Polycarbonate (PC), IP 66			
Dimension	Code	Symbol	Description
342 x 295 x 88	8561824	AR IPW 1210 BT	IPW Inspection protection window, 342 x 295 x 88 mm, DB3 lock (transparent cover)
452 x 400 x 88	8561804	AR IPW 1614 BT	IPW Inspection protection window, 452 x 400 x 88 mm, DB3 lock (transparent cover)

VENTILATION DEVICES

Ventilation devices			
Dimensions	Code	Symbol	Description
70 x 50 x 20	3541564	MB 10564 II	Ventilation device (IP 44, gasketed) incl. screws
	3540858	MB 10858 II	Grille/filter holder for MB 10564 II
	3540859	MB 10859 II	Holder for fan incl. screws
M12 x 1,5	7016702	GVPPA M12	Pressure equalizer plug (IP 68, light grey) length 6 mm
M12 x 1,5	7016700	GVPPA M12L	Pressure equalizer plug (IP 68, light grey) length 10 mm
M40 x 1,5	8818223	GVPPA M40	Pressure equalizer plug (IP 66, light grey) length 18 mm
PG 13,5	3540631	MB 10631	Ventilation device (IP 33)
ø8,5 mm	4512189	MB 12189	Draining plug (IP 34)



SALES OFFICES

Fibox Oy Ab

Keilaranta 19, 02150 Espoo, FINLAND
Tel: +358 207 785 700, Fax: +358 207 785 702
E-mail: info@fibox.fi

Fibox AB

SWEDEN
Tel: +46 8 792 2670, Fax: +46 8 792 0164
E-mail: info@fibox.se

Fibox A/S

Taastrup Hovedgade 101, 1. sal, 2630 Taastrup,
DENMARK
Tel: +45 4371 8055
E-mail: fibox@fibox.dk

Fibox Limited

Suite 25, Durham Tees Valley Business Centre,
Primrose Hill Industrial Estate, Orde Wingate Way,
Stockton on Tees, TS19 0GD, ENGLAND
Tel: +44 1642 604 400, Fax: +44 1642 604 600
E-mail: salesuk@fibox.com

Fibox France Sarl

Neptune II, 35 bis, av. Saint Germain des Noyers
77400 Saint Thibault des Vignes, FRANCE
Tel: +33 16021 2217, Fax +33 16021 1718
E-mail service.client@fibox.fr

Fibox GmbH

Rehwinkel 30, 32457 Porta Westfalica,
GERMANY
Tel: +49 5731 86946 0, Fax: +49 5731 86946 50
E-mail: info@fibox.de

Fibox LLC

Office B 21, 54 B Shpalernaya st. St. Petersburg,
191015 RUSSIA
Tel: +7 921 9640135

Fibox India Private Limited

Gat No- 147, A II & III, Chakan Talegaon Road,
Near Rinder Automation, A/p- Mahalunge,
Tal-Khed, Dist-Pune, Maharashtra, INDIA- 410501
Tel: +91 02135 666777
Fax: +91 02135 666789
E-mail: viren.shah@fibox.com

Fibox Japan Office

Zip# 542-0081 303, Daiwa building,
2-4-19, Minamisenba, Chuo-Ku, Osaka, JAPAN
Tel: +81 6 4963 3752, Fax: +81 6 4963 3762
Mobile: +81 90 2705 6742
E-mail: m.takeda@fibox.co.jp

Fibox Benelux

Postbus 350, 7570 AJ Oldenzaal,
THE NETHERLANDS
Tel: +31 541 539039, Fax: +31 541 533399
E-mail: info@fibox.nl

Fibox (Schweiz) GmbH

Wissenschwändi 6, 6314 Unterägeri,
SWITZERLAND
Tel: +41 55 617 20 80, Fax: +41 55 617 20 89
E-mail: info@fibox.ch

Fibox Sp. z o.o.

ul. Dziecioła 19, 04-988 Warszawa, POLAND
Tel: +48 22 256 57 99, Fax: +48 22 256 57 90
E-mail: info@fibox.pl

Fibox Inc.

810 Cromwell Park Drive Suite R, Glen Burnie,
MD 21061 USA
Tel: +1 410 760 9696, Fax: +1 410 760 8686
E-mail: sales@fiboxusa.com

Fibox Shanghai Ltd.

F1 BLD 11, No.999, Jiangyue Rd.,
Pujiang Chiyat Center, Minhang District,
Shanghai 201114, CHINA
Tel: +86 21 6495 9922, Fax: +86 21 6495 9667
E-mail: infocn@fibox.com

Fibox (Guangzhou) Engineering Plastic Co., Ltd

No.36 Dong-Peng-Da-Dao, Fibox Road,
Guangzhou Economic & Technological
Development District, 510530 Guangzhou,
Guangdong, CHINA
Tel: +86 20 3206 7660, Fax: +86 20 3206 7661

Fibox Ltd (Korea)

11-25, Songdo-dong Yeonsu-gu, Incheon,
KOREA (South)
Tel: +82 32 814 6742, Fax: +82 32 814 6077
E-mail: sales@fibox.co.kr

PRODUCTION SITES

Fibox PAM Oy Ab

Rajasilta 6, 33880 Lempäälä, FINLAND
Tel: +358 207 785 700, Fax: +358 207 785 801
E-mail: info@fibox.fi

Fibox Tested Systems Oy

Hovinpelto 2, 74700 Kiuruvesi, FINLAND
Tel: +358 207 785 700, Fax: +358 207 785 851
E-mail: tested.myynti@fibox.com

Fibox Tested Systems

ul. Dziecioła 19, 04-988 Warszawa, POLAND
Tel: +48 22 256 57 99, Fax: +48 22 872 96 98
E-mail: info@fibox.pl

Fibox Inc.

810 Cromwell Park Drive Suite R, Glen Burnie,
MD 21061 USA
Tel: +1 410 760 9696, Fax: +1 410 760 8686
E-mail: sales@fiboxusa.com

Fibox India Private Limited

Gat No- 147, A II & III, Chakan Talegaon Road
Near Rinder Automation, A/p- Mahalunge,
Tal-Khed, Dist- Pune, Maharashtra,
INDIA- 410501
Tel: +91 02135 666777
Fax: +91 02135 666789
E-mail: viren.shah@fibox.com

Fibox Shanghai Ltd.

F1 BLD 11, No.999, Jiangyue Rd.,
Pujiang Chiyat Center, Minhang District,
Shanghai 201114, China
Tel: +86 21 6495 9922, Fax: +86 21 6495 9667
E-mail: infocn@fibox.com

Fibox Ltd (Korea)

11-25, Songdo-dong Yeonsu-gu, Incheon,
KOREA (South)
Tel: +82 32 814 6742, Fax: +82 32 814 6077
E-mail: sales@fibox.co.kr

Fibox (Guangzhou) Engineering Plastic Co., Ltd

No.36 Dong-Peng-Da-Dao, Fibox Road
Guangzhou Economic & Technological
Development District, 510530 Guangzhou,
Guangdong, CHINA
Tel: +86 20 3206 7660, Fax: +86 20 3206 7661

Fibox GmbH

Rehwinkel 30, 32457 Porta Westfalica,
GERMANY
Tel: +49 5731 86946 0, Fax: +49 5731 86946 50
E-mail: info@fibox.de



FIBOX

Enclosing innovations

Fibox Oy Ab

Keilaranta 19, 02150 Espoo, FINLAND

Tel: +358 207 785 700

Fax: +358 207 785 702

E-mail: info@fibox.fi

fibox.fi



6 418074 311092

Code: 9637271

X-ON Electronics

Largest Supplier of Electrical and Electronic Components

Click to view similar products for [Mounting Fixings](#) category:

Click to view products by [Fibox](#) manufacturer:

Other Similar products are found below :

[007310](#) [007541](#) [61-068636-79P](#) [6-141-P](#) [620HA038NF09](#) [620HA038NF11](#) [M81714/60-12-01](#) [M81714/60-22-01 L/C](#) [70-584649-01P](#) [71-074914-006](#) [71-146610-6H](#) [712HA170B23128-N](#) [71-441864-5S](#) [75-69116-8S](#) [75-69211-3P](#) [75-69220-27S](#) [75-69224-5S](#) [770-006A109](#) [770-006A109R](#) [770-006A207](#) [770-006A208W1](#) [770-006A209](#) [770-006A306](#) [770-006A703W1](#) [770-006A704](#) [770-006A704W1](#) [770-006A705](#) [770-006A706](#) [770-006A706W1](#) [770-006A707](#) [770-006A709](#) [770-007A203](#) [770-007A203W1](#) [770-007A204W1](#) [770-007A207W1](#) [770-007A703](#) [770-007A704W1](#) [770-007A706](#) [770-007A707W1](#) [770-010Y208](#) [770-010Y308](#) [770-010Y705](#) [770-010Y706](#) [770-010Y707W1](#) [770-011T201](#) [770-011T203](#) [770-011T701W1](#) [770-011T702](#) [770-011T702W1](#) [770-011T703](#)